

User guide

Freiheit® Freedom walking frame



Code: **1551** Freiheit® Freedom Eco walking frame

Code: **1552** Freiheit® Freedom Narrow walking frame

Code: **1553** Freiheit® Freedom Standard walking frame



Code: **1551**



Code: **1552**



Code: **1553**

Contents

1	Definitions	5	Care and maintenance	11	Storage
1	Intended use	6	Maintenance schedule	11	Disposal
1	Safety warnings	7	Servicing	11	Environmental conditions
2	List of components	8	Product labels	11	Life time
3	Instructions for use	9	Troubleshooting	11	Limited warranty
5	Attatching and using accessories	10	Product specifications		
		11	Product compliance		

Definitions

Symbols used in this user guide and their meanings.



WARNING! Failure to heed this warning may result in damage to the product or serious injury to the operator/user.



CAUTION! Beware of pinch points.



ATTENTION! Read and understand the instructions in the user guide before using the product.

Intended use

The Freiheit Freedom walking frames with 200mm wheels are designed for people with restricted mobility and a maximum body user weight of 150kg who require additional support while walking. They should be used as a tool to assist people who have mobility difficulties with standing, walking or sitting independently.

The walking frame is suitable for indoor and outdoor use on solid and level surfaces.

SAFETY WARNINGS



ATTENTION! This user manual must be read before using the walking frame. Severe injury or death may result if user instructions, maintenance instructions and product warnings are not followed.



WARNING! The decision to use this walking frame should always be guided by a qualified Health Care Professional, who can also advise and assist with the correct height adjustment and usage instruction.



CAUTION! Fingers or other body parts can be trapped between the walking frame's folding mechanism during operation. Be extremely careful when adjusting the walking frame. Observe the dimensions of gaps between the walking frame's elements to avoid trapping your fingers or other body parts.

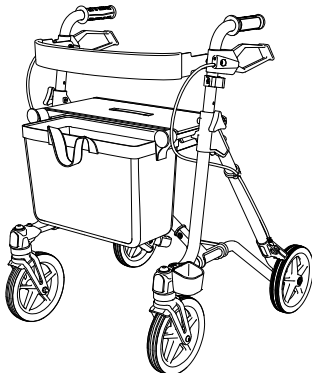

- **DO NOT** exceed the maximum weight capacity (including bag contents) or serious injury could result: **Maximum weight capacity: 150kg**
- Before each use, check that all attached parts are properly fastened, that the brakes are working and that the folding mechanism is locked
- Instruction and practice are necessary for successful use of the walking frame
- Ensure handbrakes are fully operational before each use
- Suitable for indoor and outdoor use on level, firm surfaces
- Always lock the handbrakes when the walking frame is in a stationary position
- Use the walking frame only for the purpose it is intended for
- **DO NOT** stand on the walking frame
- **DO NOT** hang anything from the frame or handles of the walking frame
- Ensure left and right handles are level to avoid instability problems
- Note that a shift of balance due to body movements may increase the risk of the walking frame tipping over. Always make sure the load on the walking frame is even
- **DO NOT** use your walking frame until the handles are properly adjusted and securely tightened

- **DO NOT** use on stairs, escalators or any uneven surfaces
- Make sure the walking frame is fully opened before use
- **DO NOT** use the walking frame to pull up on. It is not a transfer aid
- **DO NOT** exceed the weight limitation of the bag. The bag has a weight limitation of 5kg
- Always lock brakes when using the walking frame seat
- **DO NOT** use the walking frame as a wheelchair; doing so may cause a tip over, resulting in injury
- Surface temperatures of the walking frame can increase/decrease when exposed to external sources of heat (e.g. sunlight, outdoor environment)
- The walking frame seat is only designed to be used for short periods, such as when taking a break from walking
- This walking frame is not suitable for children



WARNING! BEFORE USE make sure the handle height adjustment knobs are tight and the folding lock is firmly down. Check brakes are working correctly.

List of components

The Freiheit® Freedom walking frames are supplied folded in a box, for easy transportation. The contents include one complete Freiheit walking frame, one bag and one user manual.

1. Comfort backrest
2. Ergonomic hand grips
3. Brake lever
4. Locking pin
5. Side reflectors (Narrow and Standard)
6. Mesh bag
7. Front reflectors (Narrow and Standard)
8. Cane holder (upper part)
9. Locking pin
10. Reflectors (Eco)
11. Cane holder (low part)
12. Brake

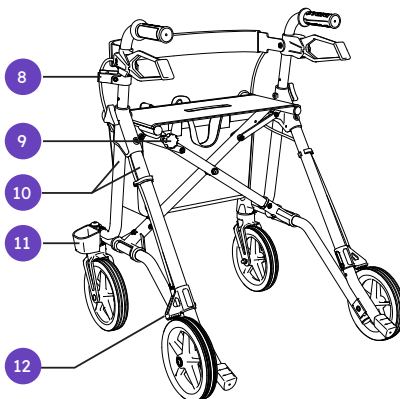
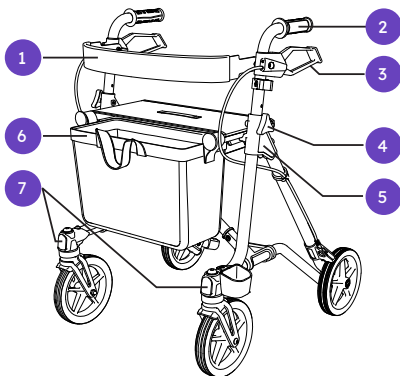

Instructions for use



CAUTION! Beware of pinch points. Take care not to trap your hands, fingers or clothing when operating the folding lock and when unfolding/folding the walking frame.

Setting up/unfolding the walking frame

- Position the walking frame in front of you with the handles pointing towards you
- Push the side tubes of the seat apart and down until the walking frame has unfolded completely **A**. The folding lock (red button, **B**) must audibly click into place

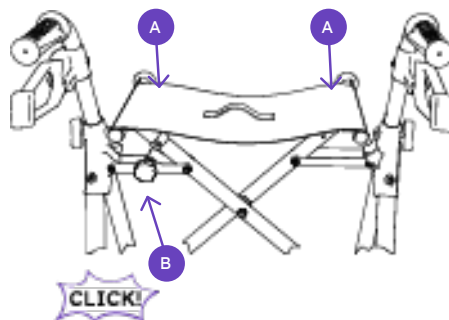

Adjusting the handle height

- Loosen screw **C** and remove it completely
- Adjust the grip handles to the height desired
- Place screw **C** back in its hole and tighten it firmly



WARNING! Only use the walking frame if the folding lock is correctly engaged.



WARNING! Ensure the frame is fully open before use.

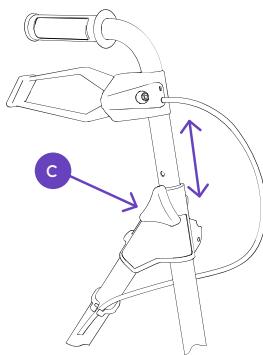

Selecting the appropriate height

It is important to set the walking frame to the correct height; seek guidance from your Health Care Professional for the appropriate height level to suit your needs. When the frame height is correct you should be able to maintain an upright posture with the elbow slightly flexed. In this way, body weight is taken through the frame by pushing down on the frame when walking with.

- You should not have your shoulders raised or dropped when using the walking frame



WARNING! Seek advice from a qualified Health Care Professional for the appropriate height to suit your needs.



CAUTION! Beware of pinch points when adjusting any of the walking frame functions.

The general guide is:

- Stand with your arms relaxed at your side
- The top of the walking frame handle should be aligned with the wrist. (You can also align with the hip joint area but the wrist measurement is more often correct.)

Braking

To reduce speed while walking, pull both levers evenly and gently upwards. Always apply the same amount of power on both brake levers **D**.

Brake adjustment

Check that the brakes are correctly adjusted as follows:

- The brake lever and the Bowden cable must not be loose (they must not have any play)
- When you release the brake lever, the wheels must turn without making any scraping noises
- If necessary, the braking effect can be adjusted using the adjusting screw **E** of the Bowden cable on the brake pads of the rear wheels

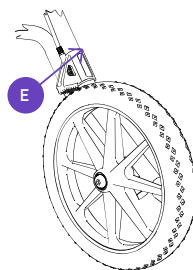
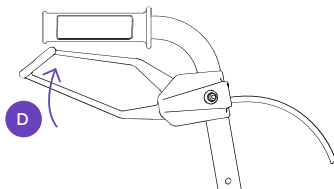

Parking braking

- To block the brakes (parking brake), press the brake levers downwards **F**. They will click into place audibly and automatically
- To release the brakes, press the levers back upwards **F** (see drawing)

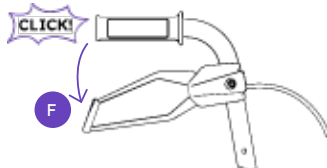

WARNING! Never fully unscrew the screw, otherwise the brake will no longer work.



WARNING! When using the walking frame in a stationary position, the hand brakes **MUST** always be locked.

Folding up your walking frame

- To fold the walking frame, release the folding lock **G** by pulling the red button towards yourself
- At the same time, pull the seat upwards using strap **H**
- The walking frame will fold up automatically

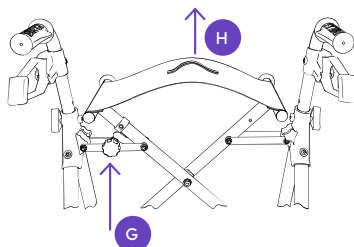

CAUTION! Beware of pinch points. Take care not to trap your hands, fingers or clothing when operating the folding lock and when unfolding/folding the walking frame.

Attaching and using accessories

Mesh bag

The bag is approved for transporting objects up to a maximum weight of 5kg.

- To attach the bag, take hold of the two side loops **I** and hang them over the two holding rods
- To remove the bag, take hold of the two loops again and pull the bag forwards and off the rods
- To pick up the mesh bag using the carrying straps **J**, place the bag briefly on the ground and then take hold of the straps on both sides

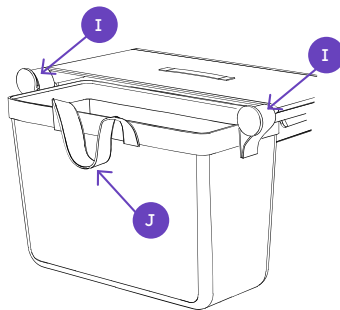

Cane holder

The cane holder is already fitted on the right hand side of your walking frame on delivery.

To insert your walking stick, first position the rubber base of the walking stick in the lower section of the cane holder **K**.

Then use slight pressure to click the stick into the upper clip of the cane holder **L**.

If having the cane holder positioned on the left-hand side would be more practical for you, the upper and lower sections of the cane holder can be released and attached to the left-hand side. Please contact your authorised specialist retailer to have this installed.

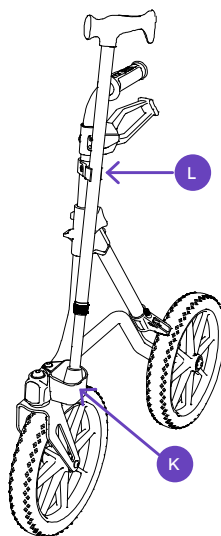

Care and maintenance

Cleaning

- Clean the walking frame by regularly wiping the frame parts with a damp cloth. If the walking frame is very dirty, you can use a mild detergent and warm water
- The seat cover and shopping bag can be hand-washed in mild soapy water of up to 40°C
- The wheels can be cleaned using a damp brush with soft plastic bristles

- Remove dirt and fluff from the wheel hubs
- Only ever use standard mild cleaning and disinfection products to clean the walking frame. Detailed information on disinfection can be found in the following section



WARNING! After cleaning, ensure that all materials are completely dried in order to preserve their quality.

Disinfection

Please only use the following disinfectants; use of other chemicals might damage the walking frame:

- Aldehyde-free disinfectants based on alcohol (max. 70% propylalcohol)
- Aldehyde-based disinfectant



WARNING! Do not use high-pressure cleaners, strong, corrosive chemicals or scouring agents for cleaning purposes.





WARNING! Observe the use and processing instructions issued by the cleaning agent/ disinfectant manufacturer.

Maintenance schedule

Maintenance schedule: Before use



WARNING! If faults are found during any inspection, remove from use immediately.

What to check	Description
Brakes/parking brakes: function	If the brake handles are pushed down/locked (parking brake) or the brake handles are actuated (service brake), the rear wheels must not turn.  The brakes must be reconfigured after replacing the Bowden cables or rear wheels. This must only be performed by the authorised specialist retailer.
Push handles: stability	<ol style="list-style-type: none">1. It must be possible to firmly lock the star screws on the push handles2. The push handles must not wobble
Folding lock and folding mechanism: Function and safety	<ol style="list-style-type: none">1. It must be easy to pull out the folding lock (red button) and engage it again2. It must be easy to push the two parts of the frame together and apart
Screw connections Securely fastened	All screw connections must be securely fastened.  Repeated loosening and re-tightening causes self-locking nuts and screws to lose their effectiveness. If these screws are no longer able to be tightened securely, they must be replaced by an authorised specialist retailer.
Steering and running wheels: mobility, function and damage	<ul style="list-style-type: none">• The wheels must run in a straight line and must not wobble• The wheels must move easily and quietly during travel• The wheels must not be damaged
Solid tyres: Check for correct function and for damage	<ol style="list-style-type: none">1. Check for damage before use2. Lubricate with multi-purpose oil periodically or if wheels begin to squeak

Maintenance schedule: Monthly

What to check	Description
Steering and running wheels: mobility, function and damage	<ol style="list-style-type: none"> 1. The wheels must not be damaged and must run quietly, in a straight line and without wobbling 2. Please clean the wheel hub if it is dirty or if fluff has accumulated
Push handles: stability and damage	<ol style="list-style-type: none"> 1. The handles and brake handles must be firmly secured 2. The push handles must not have any external damage/distortion and must not wobble 3. It must be possible to firmly lock the star screws
Seat: dirt and damage	<ol style="list-style-type: none"> 1. The seat cover must be firmly positioned in the side rails 2. If the seat is dirty, clean it according to the cleaning instructions 3. If damaged, have the seat replaced
Solid tyres: Check for correct function and for damage	<ol style="list-style-type: none"> 1. Check for damage before use 2. Lubricate with multi-purpose oil periodically or if wheels begin to squeak
Frame, entire: Function and damage	<ol style="list-style-type: none"> 1. The two frame parts and cross struts must not be damaged or cracked 2. Functional damage or surface damage must be rectified
Visual inspection: Loose parts, fractures, corrosion or other damages	 <p>If this type of damage is detected, the walking frame must no longer be used. As safe operation is no longer guaranteed!</p>
Dirt: entire walking frame	The entire walking frame must be cleaned depending on how dirty it is, but at least once a month (see section "Cleaning")

Servicing

For any servicing, maintenance and troubleshooting queries, please contact the Cubro Service Department:

0800 656 527
 +64 7 578 7228
 sales@cubro.co.nz

149 Taurikura Drive, Tauriko, Tauranga,
 New Zealand



WARNING! Do not make any changes or modifications to this product without consultation from your Cubro® agent.

Product labels

Symbols on product:

	<p>Unique Device Identifier (01) UDI-DI (10) Order number (21) Serial number</p>		<p>Caution - note the safety information in the user guide</p>
	<p>Manufacturer/manufacturer's trademark/ contact address</p>		<p>Medical device</p>
	<p>Maximum safe working load</p>		<p>CE labelling</p>
	<p>Date of manufacture</p>	<div data-bbox="568 555 1034 842"> <p>DIETZ Rehab  DIETZ GmbH Reutäckerstraße 12 76307 Karlsbad DE </p> <p>TYP TaiMA XC Air</p> <p> 670 mm  850 mm - 950 mm  150 kg </p> <p>REF  200107   2019-08</p> <p>UDI  (01)04260241684834 (10)1900XXX (21)371022XXX   </p> </div>	
	<p>Total width of walking frame</p>		
	<p>Total height of walking frame (min.- max.)</p>		
	<p>The walking frame can be used both indoors and outdoors</p>		
	<p>Follow the user guide</p>		

Troubleshooting

Issue	Possible causes	Solution
The front wheels do not run in a straight line.	The wheel bearings are defective or the wheel suspension is no longer correctly attached.	Consult an authorised specialist retailer.
The walking frame is hard to push.	The wheel axles/wheel hubs are dirty.	Remove the dirt.
	The brakes are incorrectly adjusted.	Consult an authorised specialist retailer.
	The wheel bearings are defective or the wheel suspension is no longer correctly attached.	
The brake function is insufficient or uneven.	The brakes are incorrectly adjusted or the brake pad has worn out.	Consult an authorised specialist retailer.
The seat cover is not taut or not firmly connected to the walking frame.	The walking frame is not fully unfolded.	Fully unfold the walking frame and engage the folding lock.
	The seat cover is not correctly fixed in the side rails or is defective.	Consult an authorised specialist retailer.
	The cross struts or folding mechanism are defective.	
Squeaking or grinding noises.	Various causes.	Consult an authorised specialist retailer.
The walking frame does not provide secure support or does not stand reliably.	The push handles are not fixed in place properly or have been incorrectly adjusted for the user.	Check the position of the push handles. Check whether the clamping levers on the push handles are securely tightened.
	Consult an authorised specialist retailer.	Fully unfold the walking frame and engage the folding lock.
	The main structure of the walking frame or the push handles are damaged.	Consult an authorised specialist retailer.

Product specifications:

Description		Freiheit® Eco	Freiheit® Narrow	Freiheit® Standard
Code		1551	1552	1553
Safe working load	Frame	150kg	150kg	150kg
	Bag	5kg	5kg	5kg
Overall dimensions	L	680mm	620mm	680mm
	W	630mm	580mm	630mm
	D	790mm	760mm	790mm
Folded width		230mm	230mm	230mm
Seat dimensions	H	590mm	510mm	590mm
	W	450mm	390mm	450mm
Total height	min.	790mm	760mm	790mm
	max.	950mm	950mm	950mm
Handle height adjustment range		790mm - 950mm in 25mm increments	760mm - 860mm in 25mm increments	790mm - 950mm in 25mm increments
Turning radius		870mm	800mm	870mm
Frame	Material	Steel, Aluminium	Aluminium	Aluminium
	Colour	Anthracite metallic	Sepia metallic	Green metallic
Wheels	Material	PU	Rubber (EVA)	Rubber (EVA)
	Colour	Grey	Black	Black
	Dimensions	200mm × 35mm	200mm × 35mm	200mm × 35mm
Brake lever material		Polyamide with fibre glass	Polyamide with fibre glass	Polyamide with fibre glass
Grips	Material	Thermoplastic rubber	Thermoplastic rubber	Thermoplastic rubber
	Colour	Black	Black	Black
Mesh bag material		Polyester textile	Polyester textile	Polyester textile
Static stability EN ISO 11199-2	Forward	16.4°	20.0°	18.3°
	Backwards	11.0°	8.7°	10.2°
	Sideways	4.3°	3.6°	3.6°
Recommended body height		1.6m - 1.85m	1.5m - 1.75m	1.6m - 1.85m
Warranty		2 years	2 years	2 years

Product compliance

Complete test according walking frame norm	EN ISO 11199-2
Biocompatibility of plastic parts	ISO 10993
Flammability textile parts	EN 1021-2

Storage

Ensure that the walking frame is stored in a dry place protected against direct, strong sunlight and at a temperature of 0°C to +45°C. Do not activate the locking brakes. Secure the walking frame against rolling away unintentionally.

If the walking frame has been stored for a period longer than 4 months, please check all the inspection points on the walking frame listed in the maintenance schedule before reusing/redeploying it.

Disposal

Products that can no longer be used are to be disposed of separately from household rubbish. This must be done according to the local and national regulations for environmental protection and raw material recycling. Please look at your local council's website for further information on the correct disposal.

Environmental conditions

Ambient operation temperature	-10°C to +50°C
Ambient storage conditions	0°C to 45°C 20% to 75% relative humidity

Life time

The expected product service life is five years when used daily and if used as intended. This assumes compliance with the maintenance and safety specifications stipulated in this manual.

For options, accessories or parts please visit our website or contact us.

For additional copies of this user guide or for a different format, please contact Cubro®.

Limited warranty

Cubro Ltd warrants the product to be free from defects in materials and workmanship from the date of purchase for a period of 2 years (24 months). Please refer to cubro.co.nz for terms and conditions.

© Copyright 2023 Cubro® Ltd

ALL RIGHTS RESERVED: No part of this publication shall be adapted, modified, reproduced, copied, or transmitted in any form or by any means including written electronic, mechanical, reprographic, photocopying, or recording means. Furthermore, this publication shall not be stored in whole, part, adapted, or modified form, in or for any retrieval system of any nature without the written permission of the copyright holder. Applications for authorisation of a reserved right of copyright owner shall be made in writing to the publisher. WARNING: The doing of any unauthorised act in relation to a copyright work may result in both a civil claim for damages and criminal prosecution.

17/02/23

Get in touch & connect   

Email sales@cubro.co.nz • Call us **0800 656 527** • Visit cubro.co.nz

Cubro[®]