



Fraser Gazebo - Assembly instructions

Freestanding Gazebo in synthetic wood



Stools
(optional)



- Two louvred sides
- ABS roof with Skylight
- Rounded corners with smoked acrylic windows
- Bar
- 10' x 10' x 10' (290 x 290 x 285 cm.)
- 4 stools with seat covers (optional)



www.canadianspacompany.com



Before you assemble Gazebo:

PLEASE READ CAREFULLY BEFORE ASSEMBLING GAZEBO

You will need at least 2 people to erect the Gazebo. Please check that you have ALL the parts you need before assembling the gazebo (DO NOT leave Gazebo parts exposed to extreme heat prior to assembly as some materials may expand)



Solid Base

Build a solid base for your Gazebo/Spa to sit on. The overall area should be in excess of 3 x 3 metres plus additional perimeter of 0.5 meter around the outside of the structure.



Gazebo perimeter clearance

Ideally the Gazebo should be positioned at least a metre away from a neighbouring fence or hedge to allow sufficient space for manoeuvring and assembling the structure.



Orientate Gazebo

Decide how you want your Gazebo to be orientated: Your spa has two 'louvred' sides and two 'open' sides, one of the open sides will have the 'Bar' attached and the other 'open' side is to gain entry into the spa. The bar can be positioned between corners A-B, B-C, C-D.



Cover lifter clearance

As you enter the main 'open' side of the Gazebo decide in advance if you want your hot tub cover lifter to open from the 'left' or 'right' hand side and then make sure you have sufficient clearance within the structure for 'lifting' and closing the spa cover.

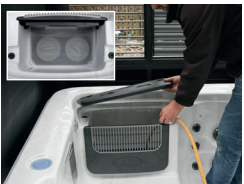

Access to power and water for Spa* / Gazebo

Before you take delivery of your Fraser Gazebo (and Spa) please take the time to decide where you want the Gazebo to be positioned with a view to access to electricity and water.

* Photo shows hot tub being filled up through the Filter basket (recommended).



Parts breakdown by section:

The main sections:

The Fraser Gazebo is comprised of 4 main sections: 1.The Wall Structure, 2.The Roof, 3.The Bar, 4. Bar Stools x 4 (optional extra)

Please check that you have ALL the parts you need before assembling the gazebo.



1. The Wall Structure:

- Gazebo corner(s) x 4
- Gazebo louvred window panel(s) x 2
- Gazebo bottom wall panel(s) x 2
- Gazebo corner connecting beam(s) x 2



2. The Roof:

- Corner joist bracket (triangular) x 4
- Roof Frames x 8
- Roof Rafters x 8
- Roof Hip rafter(s) x 8
- Roof Joist(s) x 8
- Roof Crossmember(s) - Long x 8
- Roof Crossmember(s) - Short x 8
- Skylight collar x 1
- Skylight x 1
- 90° Bracket x 12
- Straight bracket x 12
- 151° Bracket x 12
- Triangular roof tiles (LEFT) x 4
- Triangular roof tiles (RIGHT) x 4
- Straight roof tiles x 4
- Corner Ridge (Hip) tiles x 4



3. The Bar:

- Bar legs x 2
- Bar table top x 1
- Brackets x 4



4. Bar Stools (4):

- Stool legs x 16
- Stool seats x 4
- Stool padded seat cover x 4
- Leg braces (short) x 16
- Leg braces (medium) x 8
- Leg braces (long) x 8
- Bar stool foot x 16
- Self tapping screws (CT-M4*50) x 32
- Self tapping screws (CT-M4*25) x 64

Tools (suggested) you will need:

1. Allen key (Included), 2. Power drill + drill bits,
3. Philips screwdriver, 4. Spanner(s), 5. Spirit level,
6. Mallet, 7. 'C' Clamp











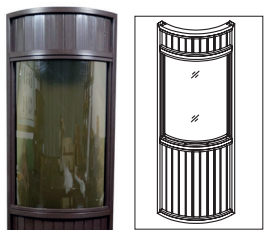
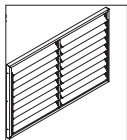

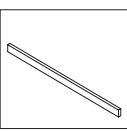



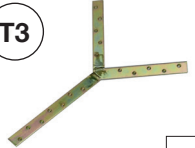
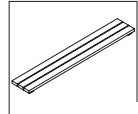

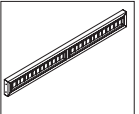





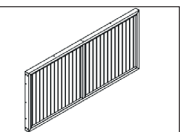



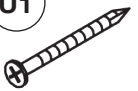
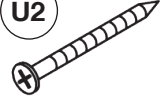

Classic Fraser Gazebo - Assembly Instructions

<p>A</p>  <p>1450 X 80 X 70mm 57⁷/₈" X 3" X 2³/₄"</p> <p>x 4</p>	<p>B</p>  <p>1965 X 90 X 70mm 77⁷/₈" X 3¹/₂" X 2³/₄"</p> <p>x 4</p>	<p>C1</p>  <p>1460 X 60 X 35mm 58¹/₂" X 2³/₈" X 1³/₈"</p> <p>x 4</p>	<p>C2</p>  <p>1460 X 60 X 35mm 58¹/₂" X 2³/₈" X 1³/₈"</p> <p>x 4</p>
<p>D</p>  <p>590 X 90 X 35mm 23¹/₄" X 3¹/₂" X 1³/₈"</p> <p>x 4</p>	<p>D2</p>  <p>300 X 90 X 35mm 12³/₄" X 3¹/₂" X 1³/₈"</p> <p>x 4</p>	<p>E</p>  <p>886 X 60 X 35mm 35⁷/₈" X 2³/₈" X 1³/₈"</p> <p>x 4</p>	<p>F</p>  <p>886 X 60 X 35mm 35⁷/₈" X 2³/₈" X 1³/₈"</p> <p>x 4</p>
<p>G</p>  <p>400 X 60 X 35mm 16³/₄" X 2³/₈" X 1³/₈"</p> <p>x 4</p>	<p>H</p>  <p>400 X 60 X 35mm 16³/₄" X 2³/₈" X 1³/₈"</p> <p>x 4</p>	<p>I</p>  <p>1355 X 70 X 35mm 53³/₈" X 2³/₄" X 1³/₈"</p> <p>x 4</p>	<p>J</p>  <p>1355 X 70 X 35mm 53³/₈" X 2³/₄" X 1³/₈"</p> <p>x 4</p>
<p>K</p>  <p>1485 X 880 X 30mm 58⁷/₁₆" X 34⁵/₈" X 1¹/₈"</p> <p>x 4</p>	<p>L</p>  <p>1485 X 880 X 30mm 58⁷/₁₆" X 34⁵/₈" X 1¹/₈"</p> <p>x 4</p>	<p>M</p>  <p>945 X 864 X 30mm 37¹/₄" X 34" X 1¹/₈"</p> <p>x 4</p>	<p>N</p>  <p>945 X 864 X 30mm 37¹/₄" X 34" X 1¹/₈"</p> <p>x 4</p>
<p>O</p>  <p>720 X 115 X 50mm 28³/₈" X 4¹/₂" X 2"</p> <p>x 8</p>	<p>P</p>  <p>835 X 115 X 50mm 33" X 4¹/₂" X 2"</p> <p>x 4</p>	<p>Q</p>  <p>650 X 650 X 140mm 26⁵/₈" X 26⁵/₈" X 5¹/₂"</p> <p>x 1</p>	<p>R</p>  <p>740 X 740 X 190mm 29¹/₄" X 29¹/₄" X 7¹/₂"</p> <p>x 1</p>



Classic Fraser Gazebo - Assembly Instructions

<p>W1</p>  <p>693 X 60 X 2080mm 27¹/₄" X 2³/₈" X 81⁷/₈"</p> <p>x 4</p>	<p>W2</p>   <p>1900 X 60 X 1200mm 75³/₄" X 2³/₈" X 47¹/₄"</p> <p>x 2</p>	<p>W3</p>   <p>1900 X 90 X 35mm 75³/₄" X 3¹/₂" X 1³/₈"</p> <p>x 2</p>	<p>T1</p>  <p>x4</p>	<p>T2</p>  <p>x4</p>	<p>T3</p>  <p>x4</p>		
<p>W5</p>   <p>1900 X 290 X 70mm 75³/₄" X 11³/₈" X 2³/₄"</p> <p>x 1</p>	<p>W6</p>   <p>1900 X 200 X 60mm 75³/₄" X 7⁷/₈" X 2³/₈"</p> <p>x 1</p>	<p>W7</p>   <p>260 X 35 X 1000mm 10¹/₄" X 1³/₈" X 39³/₈"</p> <p>x 3</p>	<p>T5</p>  <p>x4</p>	<p>T11</p>  <p>x4</p>	<p>T12</p>  <p>x4</p>		
<p>W15</p>   <p>1900 X 880 X 60mm 75³/₄" X 34⁵/₈" X 2³/₈"</p> <p>x 2</p>	<p>T16</p>  <p>x8</p>	<p>T17</p>  <p>42mm / 1⁷/₁₆"</p> <p>x4</p>	<p>T18</p>  <p>63mm / 2¹/₂"</p> <p>x8</p>	<p>U1</p>  <p>5 X 90mm 3¹/₁₆" X 3⁹/₁₆"</p> <p>x4</p>	<p>U2</p>  <p>5 X 75mm 3⁷/₁₆" X 3"</p> <p>x32</p>	<p>U3</p>  <p>5 X 55mm 3¹/₁₆" X 2³/₁₆"</p> <p>x100</p>	<p>U4</p>  <p>4 X 30mm 3¹/₁₆" X 1³/₁₆"</p> <p>x232</p>
<p>U5</p>  <p>4 X 55mm 3¹/₁₆" X 2³/₁₆"</p> <p>x92</p>	<p>U6</p>  <p>4 X 20mm 3¹/₁₆" X 3⁴/₄"</p> <p>x8</p>	<p>U9</p>  <p>4 X 30mm 3¹/₁₆" X 1³/₁₆"</p> <p>x36</p>	<p>U10</p>  <p>5 X 65mm 3¹/₁₆" X 2⁹/₁₆"</p> <p>x38</p>	<p>U11</p>  <p>5 X 16mm 1⁸/₁₆" X 5⁸/₈"</p> <p>x8</p>	<p>V</p>  <p>Wedge</p> <p>x10</p>	<p>V1</p>  <p>Plastic Caps</p> <p>x26</p>	



Wall assembly

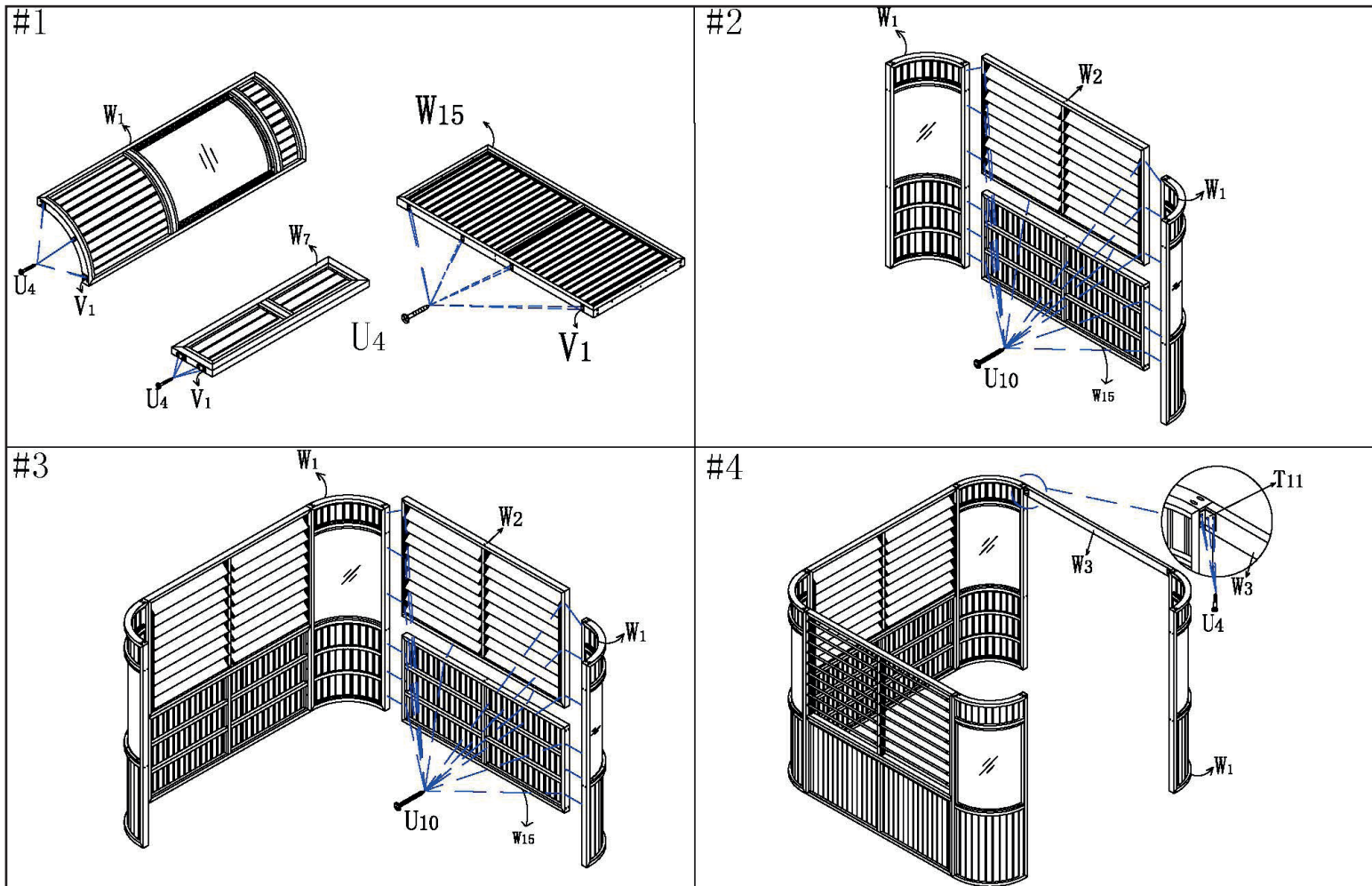

Wall assembly

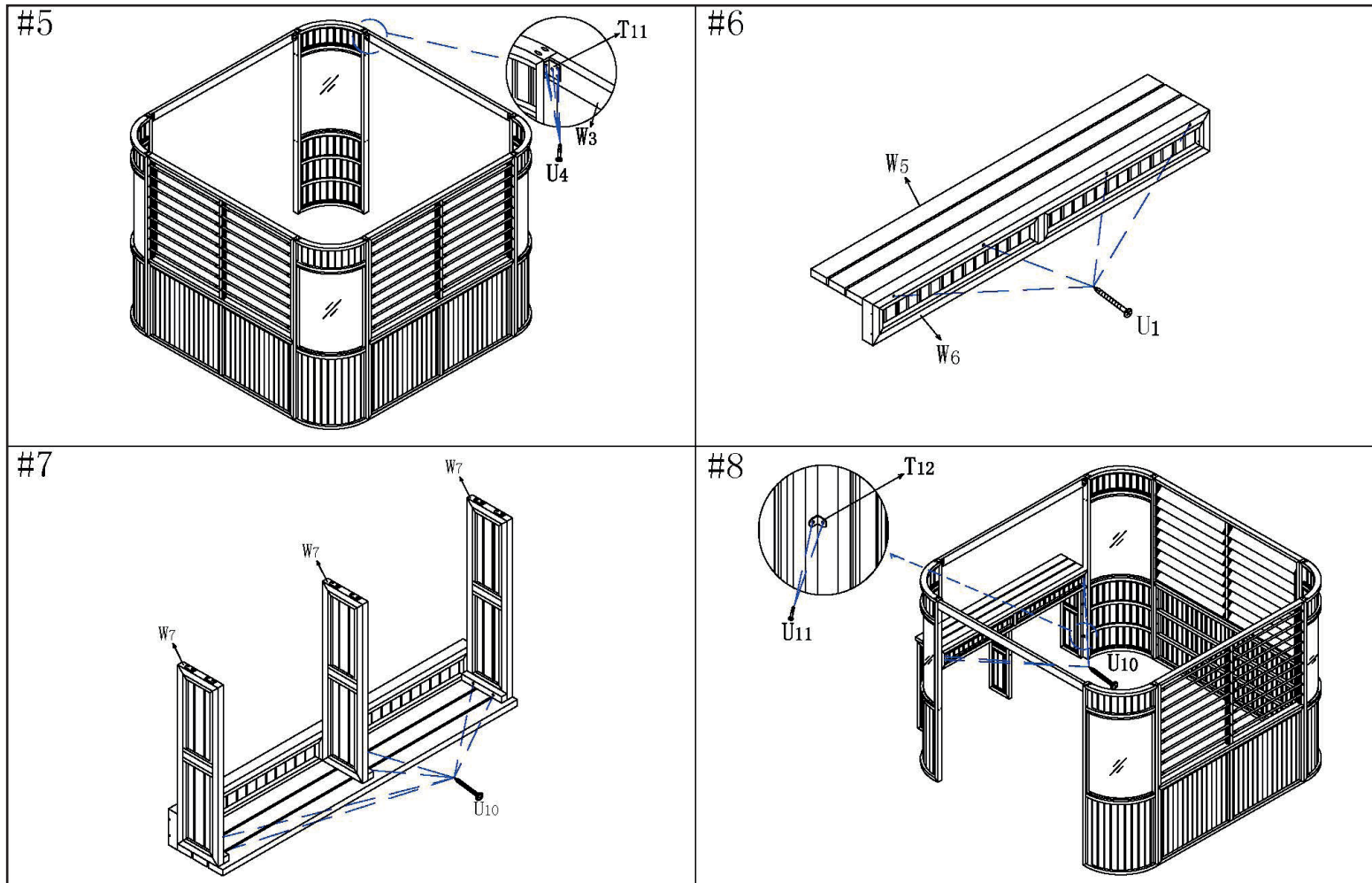

Roof frame assembly

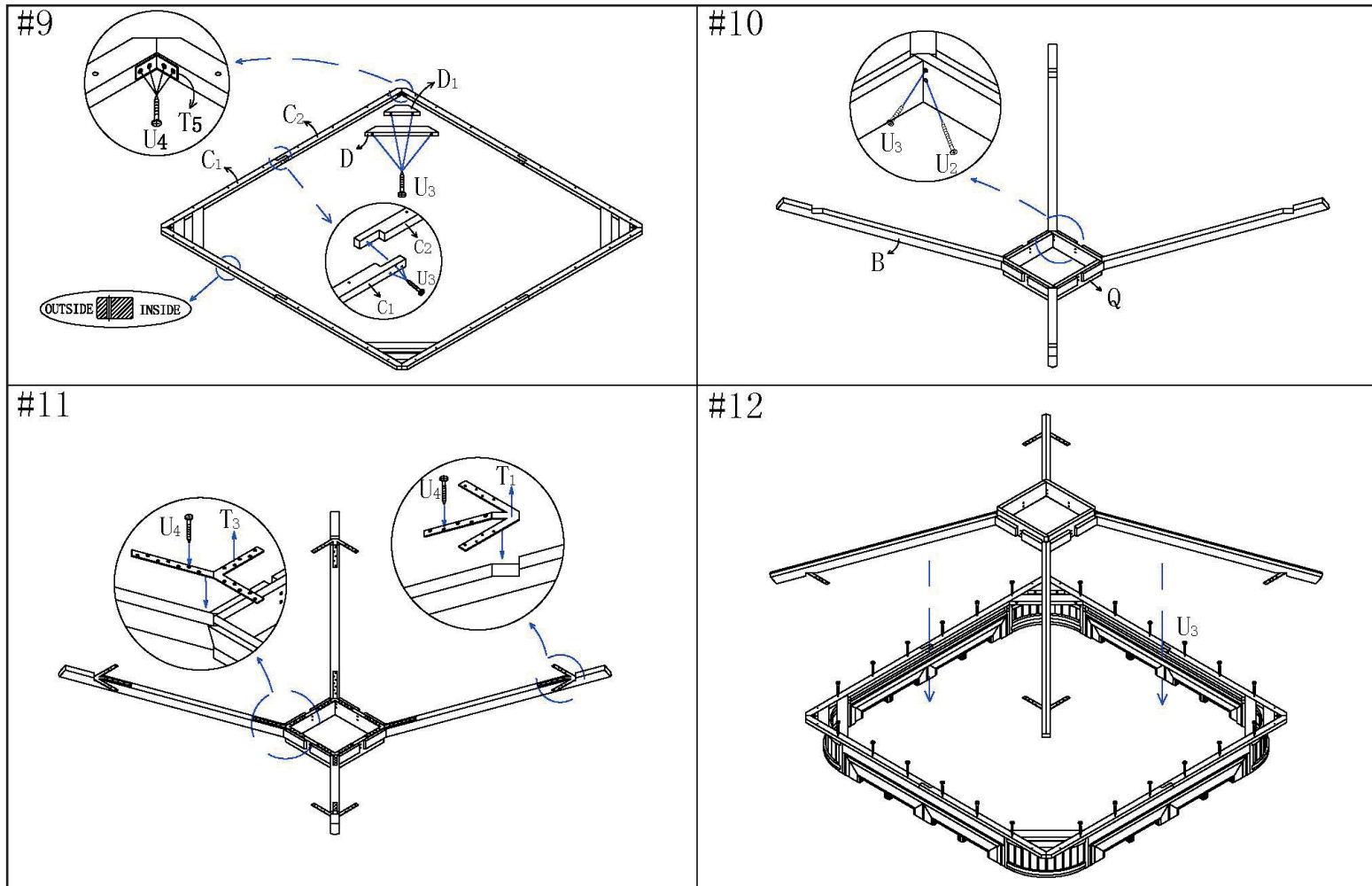

Roof frame assembly

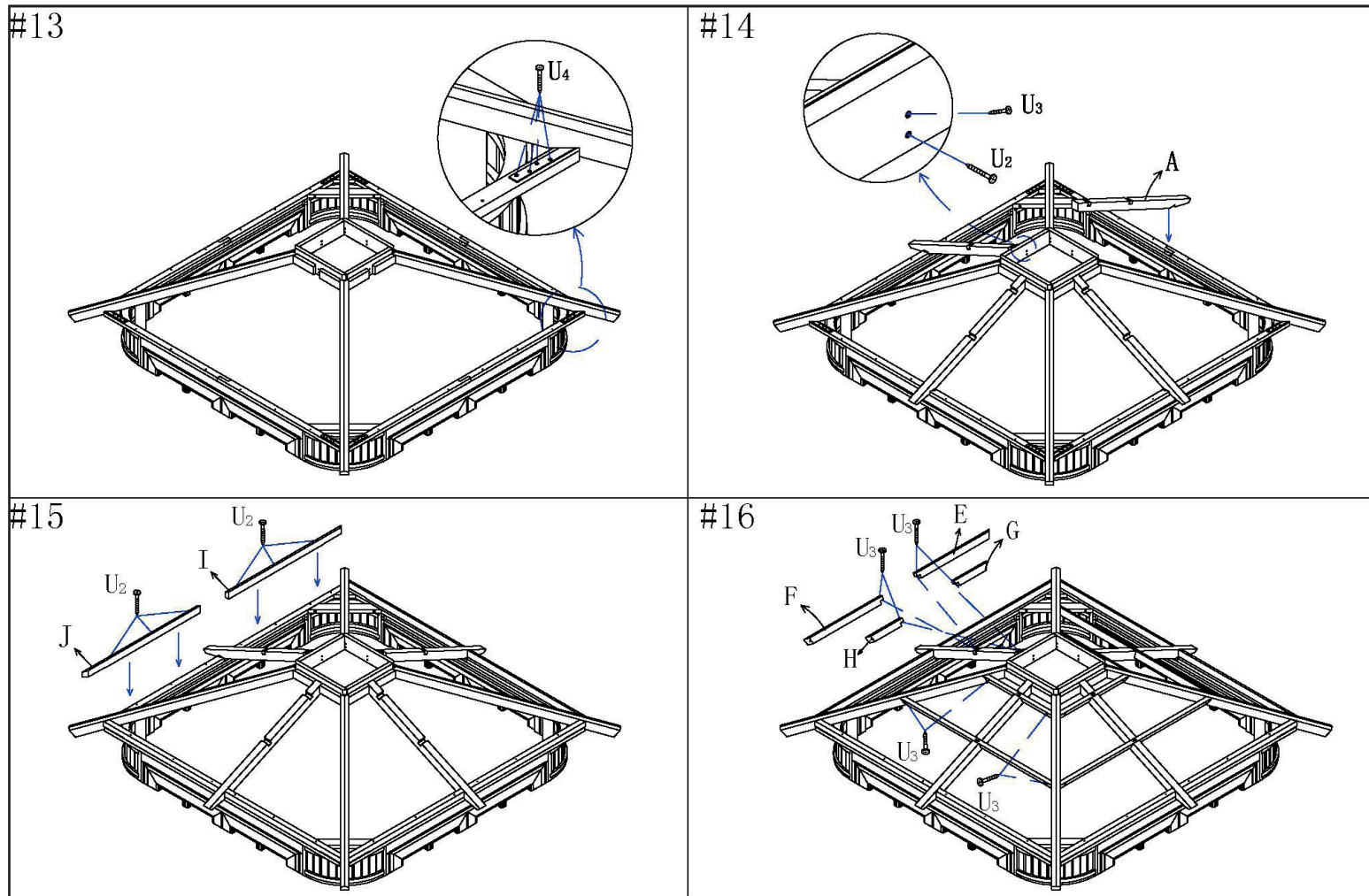

Roof frame assembly

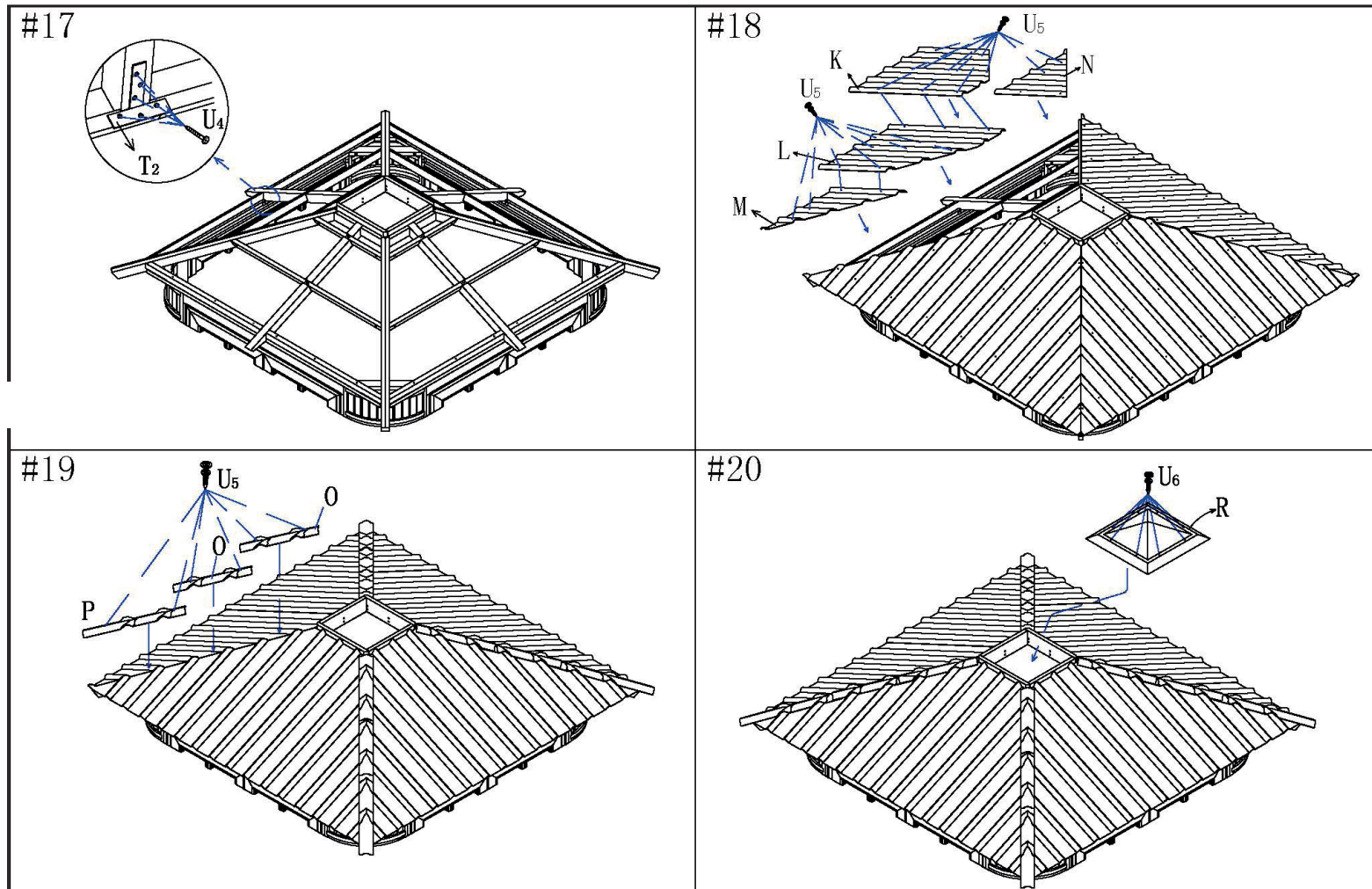

Roof frame assembly

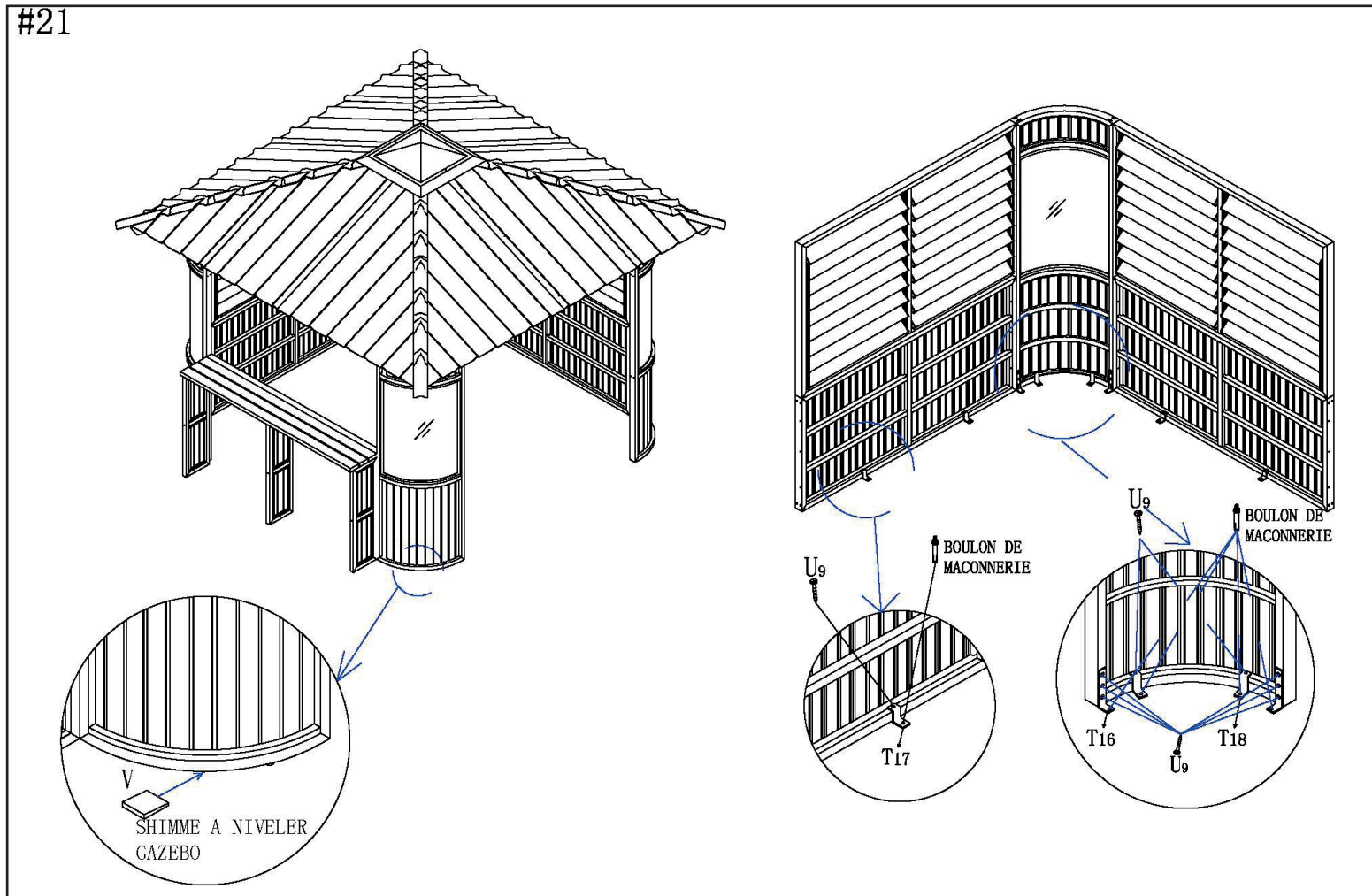



UK Office:

Canadian Spa Company
Canada House
Salbrook Road
Salfords, Redhill
Surrey, RH1 5GL
T: +44 1293 824094
E: service@canadianspacompany.com
www.canadianspacompany.co.uk

North America Office:

Canadian Spa Company
1283 Cornwall Rd, Oakville,
Ontario, Canada L6J 7T5
T: 1-877-347-7727 toll free
Fax: +1 (905) 825 2513
E: service@canadianspacompany.com
www.canadianspacompany.ca

German Office:

Canadian Spa GmbH
Hohenstaufenring 43 – 45 50674
Köln Germany
T: +49 2203806 4038
verkauf@canadianspacompany.com
www.canadianspacompany.de

USA Office

Canadian Spa Company LLC
6405 Inducon Drive West,
Sanborn, New York
USA, 14132
Tel: 1 (844) 879-7727 toll free
sales@canadianspacompany.com
www.canadianspa.com

France Office:

Canadian Spa Company
280 Rue James Watt, Perpignan,
6610 France
T: + 33 411 819 773
E: support@canadianspacompany.com
www.canadianspacompany.fr

Dubai Office:

Canadian Spa Company
Q4-124, SAIF Zone
Tel: :+971 6 573 2258
E: sales@canadianspacompany.com
www.canadianspacompany.com



Canadian Spa Company meets ISO 9001 Standards
When you purchase a hot tub from Canadian Spa
Company, the ISO 9001 certification assures world class
excellence in manufacturing and customer service. 19/06/20

