

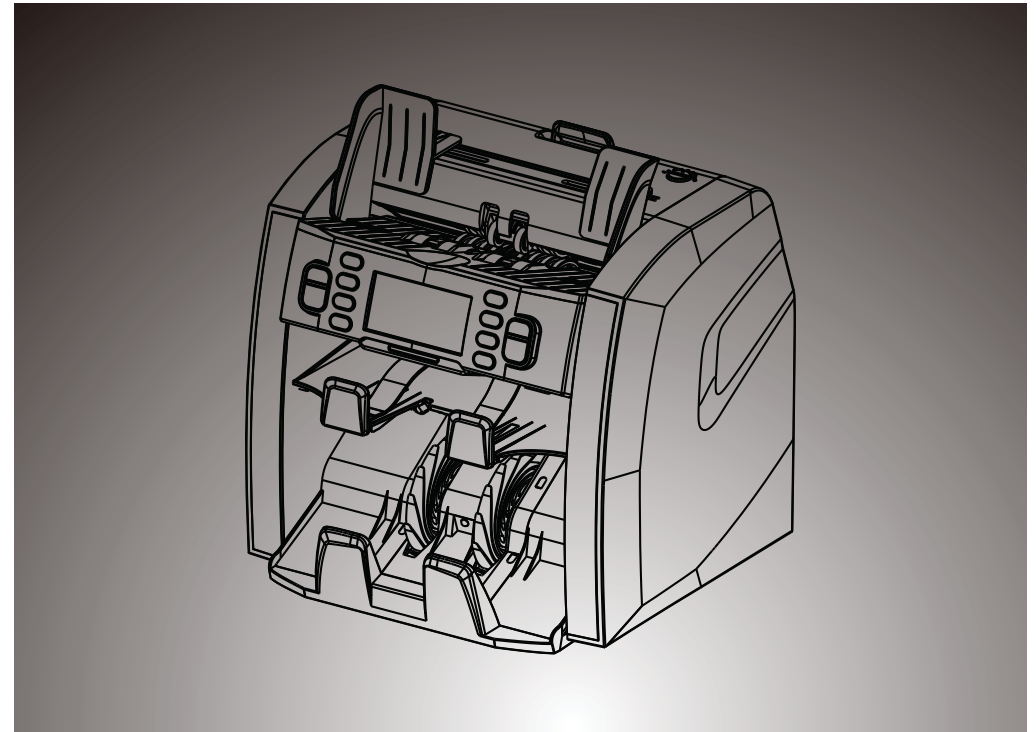

Currency Discriminator/Sorter

User Manual

CR1500



Carnation Enterprises

Contact Phone: 1-800-296-2779

E-mail: info@carnation-inc.com

Website: www.carnation-inc.com



Preface



Thank you for choosing the CR1500 currency counter/sorter. This machine represents the latest development in Carnation technology. In order to make the best use of this currency counter and its counting/sorting capabilities, please read the manual carefully, and familiarize yourself with the operating procedures.

Contents

Safety.....	1
Features.....	2
Unpacking.....	2
Exterior.....	3
Operating.....	5
Functions.....	6
User Menu.....	10
Troubleshooting.....	13
Key Points.....	18
Replacing the fuse.....	18
Maintenance.....	19
Specifications.....	20

Safety

To avoid damage to the machine and/or personal injury, read the following carefully before the first use!

	<ul style="list-style-type: none"> ● Place the unit on a solid flat surface. ● Before moving the unit, please disconnect the power cord. Damage to power cord may result in fire and/or electric shock. ● Don't place the unit on a shaky or vibrating surface. ● Keep the unit away from volatile gases or flammable materials. ● Keep the unit away from high humidity and strong sunlight, as it may cause machine's failure.
	<ul style="list-style-type: none"> ● In case of water spill, stop operating the unit immediately. Switch it off, and disconnect the power cord, then contact the service center for help. ● Plug the supplied power cord into a grounded outlet only. ● If the unit is not in use for a long period of time, please keep it switched off and unplugged to avoid possible damage.
	<ul style="list-style-type: none"> ● Please be careful to avoid any foreign objects, such as coins or staples, falling into the unit, as it may cause damage to the machine. ● It is strictly prohibited for anyone except authorized technician to open/service the machine. This will render any remaining warranty void and may cause malfunction or injury.

Features

- Detects magnetic ink, infrared ink, UV, CIS image, length, thickness of banknotes.
- Compact size, user-friendly interface with large and clear LCD display.
- Up to 4 different currencies (depending on country software), banknotes can be processed in all four orientations.
- High capacity hopper, stacker and reject pocket.
- ADD function, batch function, reporting and printing functions are available.
- Intuitive user menu and maintenance menu interface for flexible operation.
- Auto-adjustable technology, easy software upgrades via SD card or USB port.
- Configurable USB interface, printer interface, external display interface.
- Full open channel design for better maintenance and jam removal.

Unpacking

The box must contain the following:

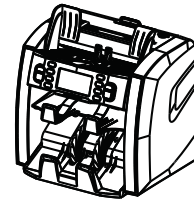

Banknote sorter



User manual



Power cable

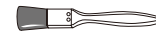

Cleaning brush



Fuse



USB download cable
(Optional)

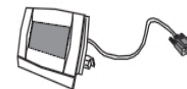

External LCD display
(Optional)



Print cable
(Optional)



SD card
(Optional)

Exterior

1. Front View

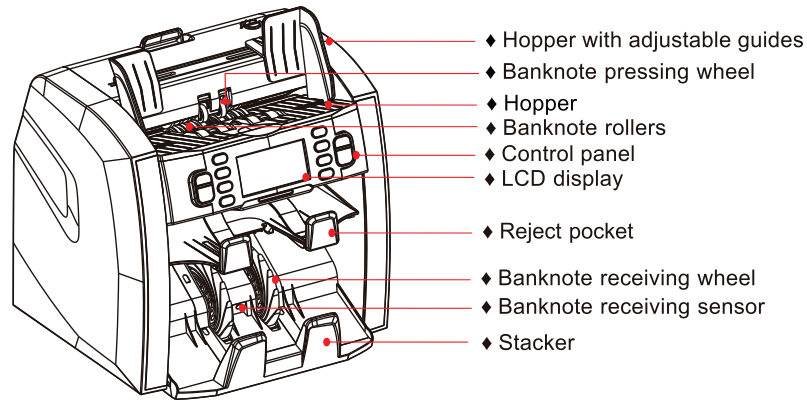

2. Rear View

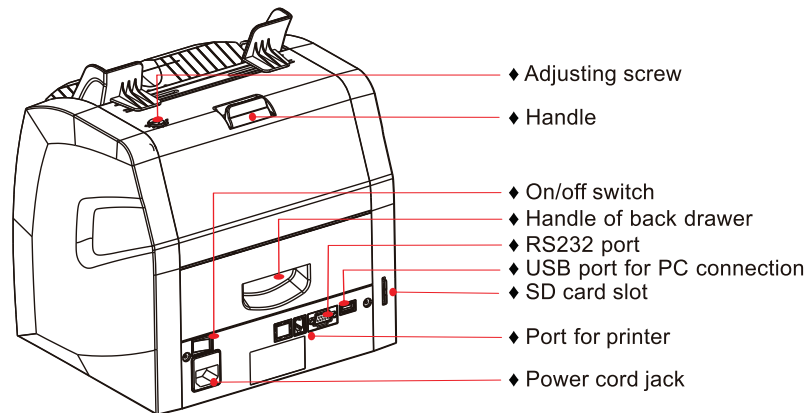

3. Panel

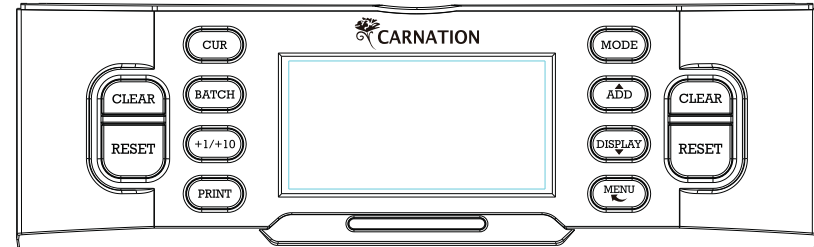

- 1] : Currency selection.
- 2] : Batch function on/off and set batch number.
- 3] : Increase the batch number by 1(short press) or 10(press and hold).
- 4] : Send count report to print.
- 5] : Counting mode settings: MIX, SINGLE, FACE, ORIENT, COUNT.
- 6] : Add function on/off. Also served as an upward navigation key.
- 7] : View the counting result report. Also serves as a downward navigation key.
- 8] : Enter/ exit device menu and go back previous level(in MENU mode).
- 9] : Clear the number of counted banknotes and turn the batch function off.
- 10] : Start counting/ Confirm selection in menu mode.

Operating

In order to avoid counting/detection errors, the following must be done before counting:

- ① Have the banknotes neatly stacked
- ② Straighten out folded notes/corners
- ③ Remove wrinkled notes
- ④ Remove any foreign objects from the notes (staples, coins)

Place the machine on a solid flat surface. Plug in the cord, and turn the machine on. Make sure all connections are secure. If you have purchased an external display, connect it to the RS232 port in the back of the machine. Avoid strong electromagnetic field or direct sunlight.

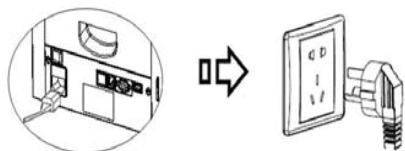

⚠ Note: In order to ensure personal safety, only use grounded electric outlets.

Turn on the power switch, the machine will display the software version first, then perform a self-test.

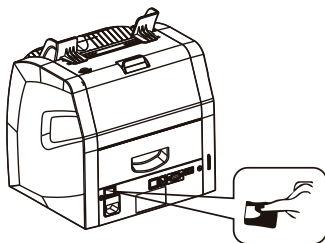

If the test is successful, the machine will enter "ready" state (See figure 1). If some error messages are displayed on the LCD, please refer to the TROUBLESHOOTING section of the manual.

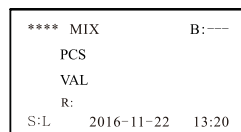
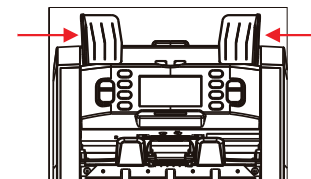
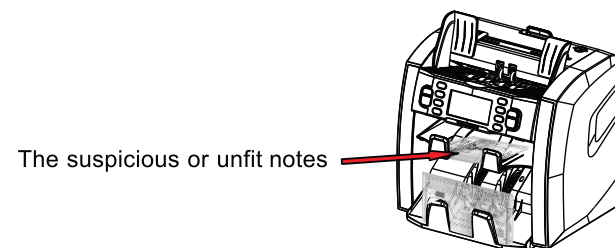

Figure 1

Before counting, please adjust the left and right hopper guides to the size of the banknotes to ensure uninterrupted feeding.



Place the well-stacked banknotes on the hopper, and the machine will start counting. The suspicious or unfit banknotes will be moved to the reject pocket.



⚠ Note: When an error occurs, and causes the machine to stop automatically, please re-count the banknotes.

Functions

1.Currency selection

When the machine is turned on, the currency mode is displayed on the LCD. If you need to count/sort another currency, press "CUR" key to change the currency, the symbols of the installed currencies will be displayed in turn:

"USD" for US Dollar

"*****" for automatic currency recognition (based on the first banknote encountered by the machine. The preloaded software includes 11 currencies. Please inquire about the availability of software for other currencies/regions.

"GBP" for Pound Sterling

"CAD" for Canadian Dollar

"BRL" for Brazilian Real

"MXN" for Mexican Peso

"COP" for Colombian Peso

"GTQ" for Guatemalan Quetzal

"DOP" for Dominican Peso

"PEN" for Peruvian Nuevo Sol

"VEF" for Venezuelan Bolivar Fuerte

"ALL" for counting without detection/currency recognition

Notice:

- ❶ When selecting currency, the speed may be set to SPEED L or SPEED M.
- ❷ When "*****" is selected, the default setting is SPEED L. Once the type currency is detected (based on the first banknote in the stack), the speed setting is automatically changed to SPEED M, but if SPEED L has been pre-selected at the outset, counting will be done at SPEED L in all modes.
- ❸ If "ALL" is selected, the speed may be set to SPEED L, SPEED M or SPEED H.

2. Counting/Sorting mode

Five counting/sorting modes are available-Mix mode,Single mode,Face mode, Orientation mode and Count mode. User can press the "MODE" button on the control panel to switch the counting/sorting mode according to requirements.

A. Mix mode

In Mix mode, "MIX" is displayed on the LCD, and the machine will count the mixed denomination banknotes of a given currency.

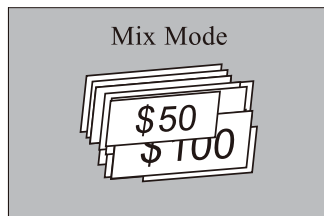

When the counting is completed, the total value and total number of banknotes are displayed on the LCD, and if "DISPLAY" button is pressed, the machine will provide a detailed report of counting results.

e.g.Example:

	Denomination	# of notes	Value
USD	1	20	20
	2	40	80
	5	20	100
	10	0	0
	20	0	0
	50	0	0
	100	0	0
Total		80	200

If the machine is connected to the printer, you can print the report by pressing the "PRINT" button.

USD		
2016-11-24 11:29:32		
Denom	Pcs	Value
USD 1	10	10
USD 5	10	50
USD 10	10	100
USD 20	10	200
Total	40	360

B. Single mode

In single mode, "SINGLE" is displayed on the LCD, and the machine will count banknotes of the same denomination. When the counting is completed, the total value and total number of banknotes are displayed on the LCD, if a suspicious or a different denomination banknote is encountered, it will be moved to the reject pocket.

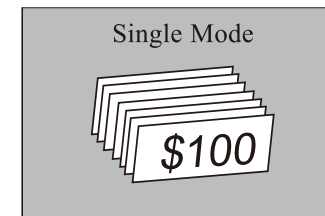

C. Face mode

In Face mode, "FACE" is displayed on the LCD, and the machine will sort the banknotes according to their front/back orientation.

The first banknote detected by the sensor becomes the reference for the rest of the stack.

The banknotes facing the other direction are then sorted into the reject pocket, including any suspicious notes (regardless of front/back orientation).

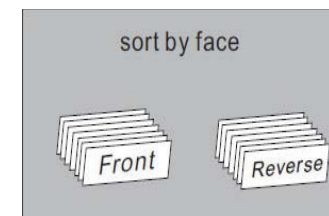

D. Orientation mode

In Orientation mode, "ORIENT" is displayed on the LCD, and the machine will sort the banknotes by right-side-up vs. upside down orientation.

The first banknote detected by the sensor becomes the reference for the rest of the stack.

The banknotes facing the other direction are then sorted into the reject pocket, including any suspicious notes (regardless of front/back orientation).

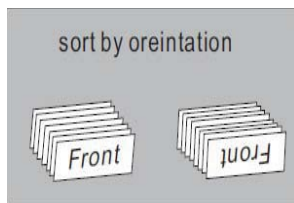

Note: We suggest sorting the banknotes in "FACE" mode first, and then in "ORIENTATION" mode.

E. Count mode

If you only need to count the number of banknotes, press the "MODE" button on the control panel. When "COUNT" is displayed on the LCD, the machine will count the number of banknotes without performing counterfeit detection/denomination recognition. When the banknote counting is completed, the total number of banknotes will be displayed.

Note: In "COUNT" mode, the counterfeit detecting function is switched off.

3. Cumulative Counting

When you need cumulative counting, press the "ADD" button on the control panel, if "ADD" is displayed on the LCD, the machine will count starting from the original number displayed on the LCD. When the counting is completed, the number displayed on the LCD is the total value of all consecutive stacks of banknotes. When the total number of banknotes reaches 9999+1, or total value reaches 999999+1, the number will be reset to 0.

USD MIX	ADD	B:---
PCS		9999
VAL		999999
R:		
S:M	26-06-2015	14:00



USD MIX	ADD	B:---
PCS		
VAL		
R:		
S:M	26-06-2015	14:00

Note: To ensure accurate counting in ADD counting mode, in case of jam or other problem, the latest batch will not be added to the total. It can be re-counted.

4. Batch Counting

When you need to count out equal batches of banknotes, press the "BATCH" button. When "100" is displayed on the LCD, the "BATCH" function has been turned on and the current batch setting is 100. Each time you press the "BATCH" button, "100, 50, 20, 10 and ---" will be displayed in turn.

When switched to "---", the batch function is disabled. You can press or hold the "+1/+10" button to increase the batch number by 1 or 10 according to the requirement of the banknotes counting. The batch value may be set in the range of 1~200. After setting the batch number, put the banknotes on the hopper, and the machine will start counting automatically. At reaching the batch number of banknotes, the machine will stop automatically. When the batch is removed from the stacker, next batch will be counted out.

User Menu

When the machine is in one of the counting modes, you can enter the user menu by pressing the "MENU" button. You can navigate to any category by pressing the "ADD" button or "DISPLAY" button.

User Menu	
1 Speed	M
2 Serial	OFF
3 R-P Capacity	50
4 Beep Setup	->
5 Date Time	->
6 Version	

1. Counting Speed

Navigate to "1: SPEED", select the counting speed by pressing "BATCH" button or "+1/+10" button (3 speed settings available). After selecting the counting speed, press the "RESET" button once again to save the changes. Press "MENU" button to exit to counting mode.

User Menu	
1 Speed	L
2 Serial	OFF
3 R-P Capacity	50
4 Beep Setup	->
5 Date Time	->
6 Version	

- "SPEED L" - low speed (800 notes/min)
- "SPEED M" - medium speed (900 notes/min)
- "SPEED H" - high speed (1,100 notes/min) !
- ❗ Serial number identification function only works with low speed setting (SPEED L)
- ❗ Serial number identification function is available in USD/EUR/GBP only.
- ❗ When a specific currency is selected, the speed may be set to SPEED L or SPEED M.
- ❗ When "*****" is selected, the default setting is SPEED L. Once the type currency is detected (based on the first banknote in the stack), the speed setting is automatically changed to SPEED M, but if SPEED L has been pre-selected at the outset, counting will be done at SPEED L in all modes.
- ❗ When selecting "ALL", the speed may be set to SPEED L, SPEED M or SPEED H.

2. Serial Number Identification

Navigate to "2 Serial", press the "BATCH" button or "+1/+10" button, and select to turn the serial number identification function on/off. Press "RESET" button to save the change. Press "MENU" button to exit.

User Menu	
1 Speed	M
2 Serial	ON
3 R-P Capacity	50
4 Beep Setup	->
5 Date Time	->
6 Version	

3. Capacity of the Reject Pocket

Navigate to "3 R-P Capacity", press the "BATCH" button or "+1/+10" button to select the capacity of the reject pocket (50, 40, 30 and 20 are available). Press "RESET" button to save the change. Press "MENU" button to exit.

User Menu	
1 Speed	M
2 Serial	OFF
3 R-P Capacity	50
4 Beep Setup	->
5 Date Time	->
6 Version	

4. Sounds Setting

Navigate to "4 Beep Setup", press "RESET" button to enter the sounds setting.

User Menu	
1 Speed	M
2 Serial	OFF
3 R-P Capacity	50
4 Beep Setup	->
5 Date Time	->
6 Version	



Beep Setup	
1 Alarm Beep	Mute
2 Key Beep	Normal

● Alarm Beep Setting

Navigate to "1 Alarm Beep", press the "BATCH" button or "+1/+10" button to switch between Alarm Beep Normal and Mute. Press "RESET" button to save the change. Press "MENU" button to exit.

❗ **Note: When Alarm Beep is on, the machine will sound when there is a rejected banknote.**

● Key Beep Setting

Navigate to "2 Key Beep", press the "BATCH" button or "+1/+10" button to switch between Key Beep Normal and Mute. Press "RESET" button to save the change. Press "MENU" button to exit.

5. Date and Time Setting

Navigate to "5 Date Time", press the "RESET" button, and set date format.

User Menu	
1 Speed	M
2 Serial	OFF
3 R-P Capacity	50
4 Beep Setup	->
5 Date Time	->
6 Version	



Date Time	
1 Date Format	YY-MM-DD
2 Date Setup	
3 Time Setup	

● Date Format Setting

Navigate to "1 Date Format" item, press the "BATCH" button or "+1/+10" button to switch the Date Format. Press "RESET" button to save the change. Press "MENU" button to exit.

● Date and Time Setting

Navigate to "2 Date Setup" or "3 Time Setup" items, press "RESET" to enter. Press the "ADD" button or "DISPLAY" button to navigate. Press the "BATCH" button or "+1/+10" button to change the date/time value. Press "RESET" button to save the change. Press "MENU" button to exit.

Troubleshooting

1. Removal of jammed banknotes

When the LCD displays "JAM! CODE=6, REMOVE ALL NOTES THEN PRESS RESET" error message during counting, please do the following:

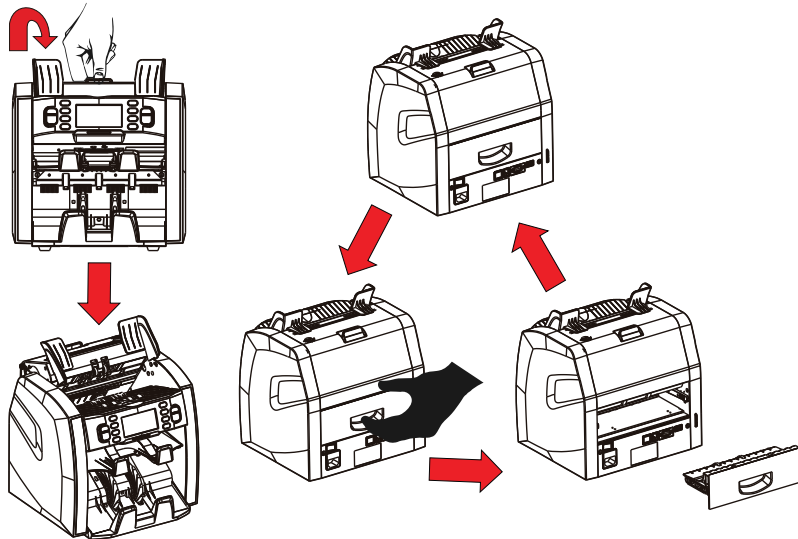

(A) Open the top cover to remove the jammed banknotes.

(B) Pull the handle of back drawer, pull the back drawer out, and remove the jammed banknotes.

2. Adjusting feeder's aperture

The adjusting screw of the feeder aperture on the top cover has already been set at the factory. You may need to adjust the feeder aperture if the following problems occur during counting/sorting:

- Frequent jams, or banknotes pass the feeder with difficulty-turn the adjusting screw clockwise to make the aperture wider.
- Frequent "double notes" or "chained notes" error message-turn the adjusting screw counter-clockwise to make the aperture smaller.

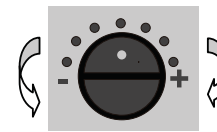

Make the aperture smaller Make the aperture wider

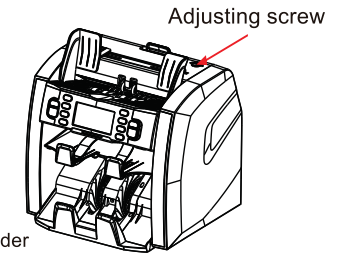

! Note: The adjusting screw is very sensitive, move only one notch at a time !

3. Self-test error message and solutions:

The machine will perform a self-test when turned on. Most of the following error messages are caused by a sensor blocked by banknotes or dust. Remove the stuck banknotes, or use a brush or a piece of soft cloth to clean the dust off the sensor, and restart the machine.

Sensors location (Open the top cover to find them)

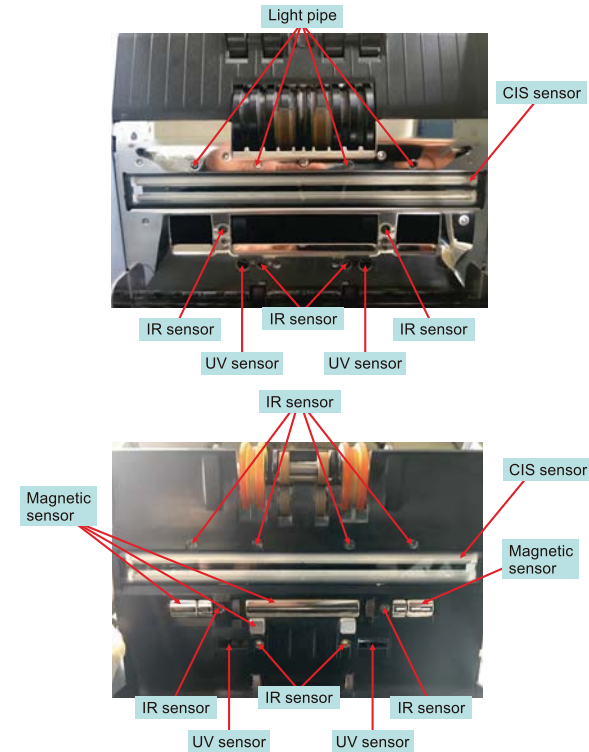

Error message displayed	Solution
Feeding Failure	Remove the banknotes from the feeder and/or remove dust from feeding sensor.
Receiving Failure	Remove the banknotes from the stacker and/or remove dust from receiving sensor.
Rejector Failure	Remove the banknotes from the reject pocket and/or remove dust from reject pocket sensor.
UV Failure	1. Adjust top cover to right position so as to avoid strong light source. 2. Remove the banknotes from the machine and/or remove dust from UV and/or FL sensor.
FL Failure	
Left#1 Counting Failure Right#1 Counting Failure Left#2 Counting Failure Right#2 Counting Failure	Remove the banknotes from the machine and/or remove dust from counting sensor.
Left CIS IR Failure Right CIS IR Failure	Remove the banknote from the machine and/or remove dust from CIS IR sensor.
Rotate#1 Speed Failure Rotate#2 Speed Failure	Remove dust from rotate speed sensor.
CIS#1 Failure CIS#2 Failure CIS#3 Failure	Remove the banknote from the machine and/or remove dust from CIS sensor.
AD Failure	Turn off the machine and restart it.
Brake Failure	Please contact your technician/dealer to replace component.
Diverter #1 Failure Diverter #2 Failure Diverter #3 Failure Diverter #4 Failure	Please contact your technician/dealer to adjust the commutator.

Left Back IR Failure	Remove the banknote from the back drawer and/or remove dust from Left Back IR sensor.
Right Back IR Failure	Remove the banknote from the back drawer and/or remove dust from Right Back IR sensor.
Please Clean Left Counting Sensor!	Remove the banknote from the machine and/or remove dust from IR sensor.
Please Clean Right Counting Sensor!	Remove the banknote from the machine and/or remove dust from IR sensor.
MG# 1 Failure MG#2 Failure MG#3 Failure	Re-plug the left magnetic board.
MG#4 Failure MG#5 Failure	Re-plug the MRS magnetic board.
MG#6 Failure MG#7 Failure MG#8 Failure	Re-plug the right magnetic board.
MID-MG Failure MID-MT Failure	Re-plug the middle magnetic board.

4. Detective error message and solutions

If one of the following error messages is displayed on the LCD during the counting/sorting, refer to the list below:

Error message displayed	Causes and solutions
UV-Error FL-Error	Remove the banknote from the machine and/or remove dust from UV or FL sensor.
MG-Error MG1-Error MG2-Error MG3-Error	Remove the banknote from the machine and/or remove dust from MG sensor.
IR-Error	Please contact your technician/dealer to adjust the counting IR.
Composed-Error	Remove the banknotes and restart the machine.

Slant Slant#1	1. Tilted banknote. 2. Place the banknotes from the banknote stacker back to the banknote hopper and re-count.
Double Chained#1 Chained#2 Chained#3	1. Some banknotes are attached to each other or overlapping. 2. Place the banknotes from the banknote stacker back to the banknote hopper and re-count. 3. If frequently displayed, turn the adjusting screw counter-clockwise to make the feeder aperture smaller.
Count	Remove the banknotes from stacker and reject pocket, and re-count.
Half	Remove the half banknote.
Width Length	Please contact your technician/dealer to do the calibration.
Image#1 Image#2 Image#3	Please contact your technician /dealer to do the calibration.
Old Ver SN-Error Face Diff Orient Diff Ver Diff Deno Diff	Remove the banknotes and re-count.
TIME 2	Remove the banknotes and re-count.
Stacker Full	Remove the banknotes from the stacker.
Rejector Full	Remove the banknotes from the reject pocket.
Bat Full	Remove the banknotes from the stacker.
Cover Open!	Close the top cover.
Back Drawer Open!	Close the back drawer.
Jam	Some foreign objects inside the machine, or banknote jammed. Open the back cover to remove them.
Mainloop Broken	Turn off the machine and restart it.

5. Sensitivity Parameters Setting

You may encounter the following problems during counting/sorting:

- Machine doesn't sort the notes properly;
- Machine frequently recognizes good notes as unfit notes;

Please contact your technician/dealer to have the machine's sensitivity parameters adjusted.

In case of a technical problem that can't be solved by operator, please contact your supplier.

Key Points:

- If the room temperature is lower than 20°C, wait 3 minutes after turning the machine on before operating.
- The machine should be operated in a room with good ventilation, and kept away from strong sunlight and/or magnetic field.
- The machine must be plugged into grounded electric outlets ONLY.
- The voltage must be in the range of 100~240V AC to avoid malfunction/breakage.
- All external rollers and wheels must NOT be oiled or greased to avoid malfunction.
- Dusts on CIS image detecting module, IR sensors, and magnetic sensor must be thoroughly cleaned at least once a week. You may remove dust build-up on the exposed parts of the machine with the brush provided.

! NOTE: Do not use any chemicals to clean this machine.

Replacing the fuse

If the machine doesn't turn on, it may be caused by a burnt fuse. Open the fuse cover holder, and replace the fuse.

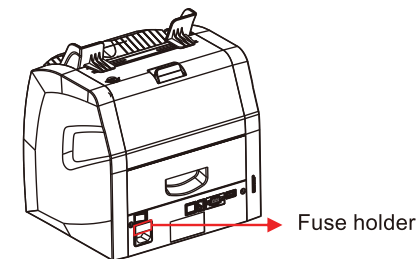

! Note: To protect against malfunction, replace only with same type and resistance fuses.

Maintenance

Cleaning the Machine

For optimal performance the machine needs to be cleaned regularly.

Clean the hopper and stacker with the enclosed brush.

Cleaning the Banknote Transport System

1. Open the upper back panel.
2. Gently wipe the banknote pathway with a small, soft brush or a dry, soft lint-free cloth.
3. If dirt remains, slightly moisten a soft cotton cloth with distilled water or a 50/50 distilled water/isopropyl alcohol solution and wipe the banknote pathway and the sensor surfaces again; Do not let any liquid drip into the device.
4. Repeat steps 1-3 to clean the banknote pathway of the lower drawer.

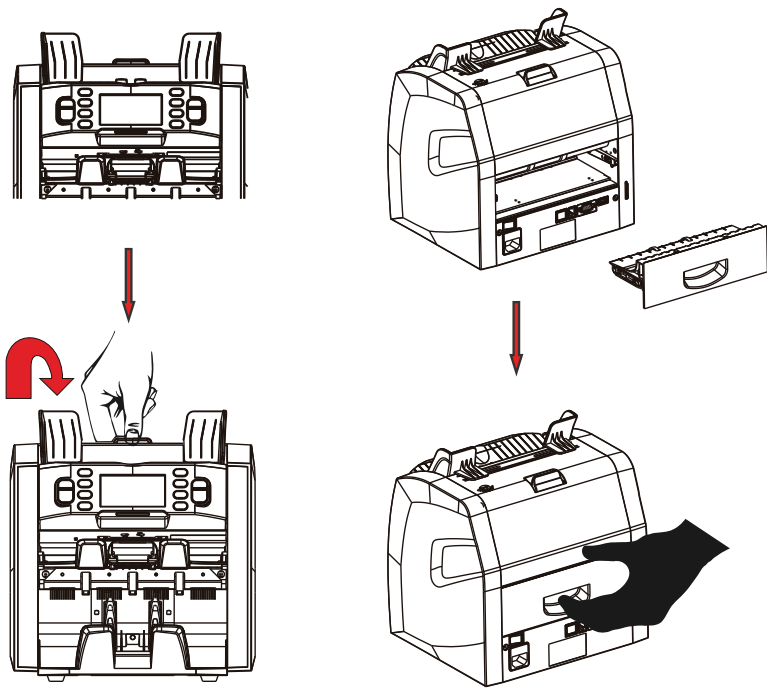

Specifications

Counterfeit detection:	IR, MG, CIS IMAGE, MT, UV
Counting speed:	800/900/1100 notes/min
Hopper capacity:	500 notes
Stacker capacity:	200 notes
Reject pocket capacity:	Max, 50 notes
Power supply:	100~240V AC, 50/60Hz
Power consumption:	≤50W
Temperature:	0°C~40°C
Humidity:	40~90%
Interface:	RS232, RJ-11, USB, SD Card
Dimensions:	9.9" (L) X10.7" (W) x10.4" (H) (251mm (L) x271mm (W) x264mm (H))
Weight:	18.7lb (8.5kg)