

Aroma Diffuser User Manual

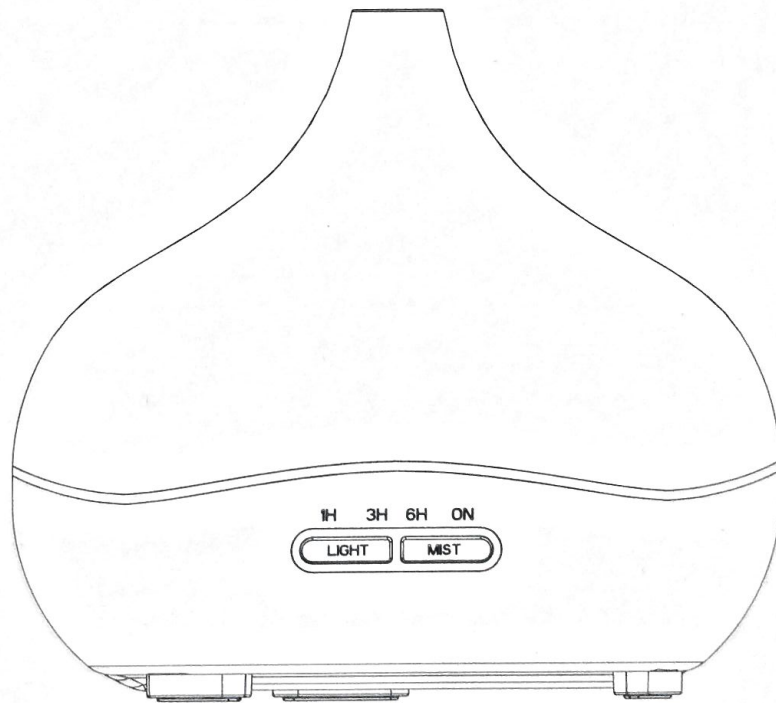

This Aroma Diffuser uses Ultrasonic waves to instantly vaporize water and essential oil in the tank, to produce a cool, dry fragrant mist.

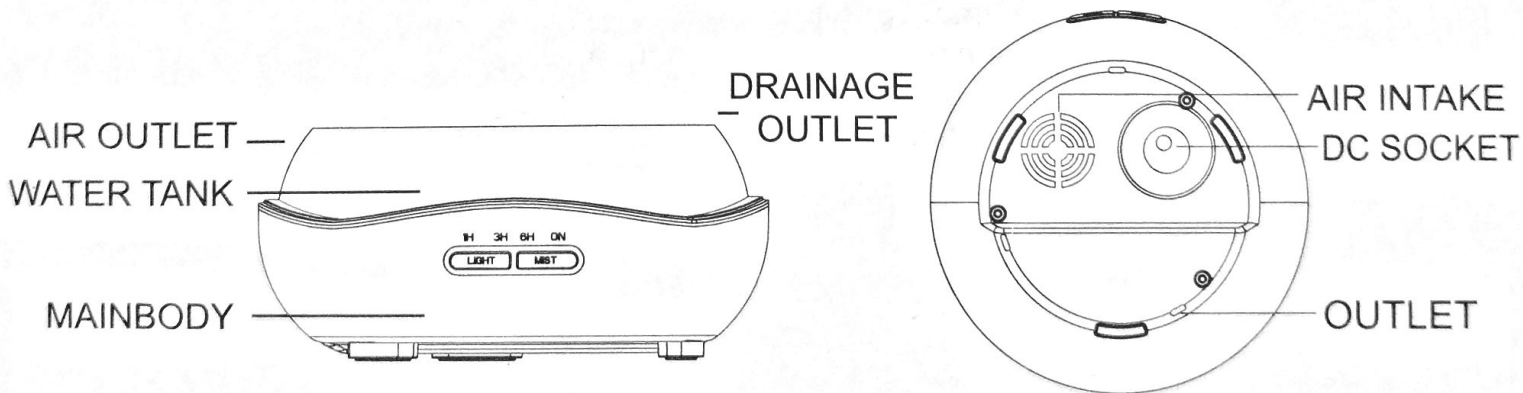
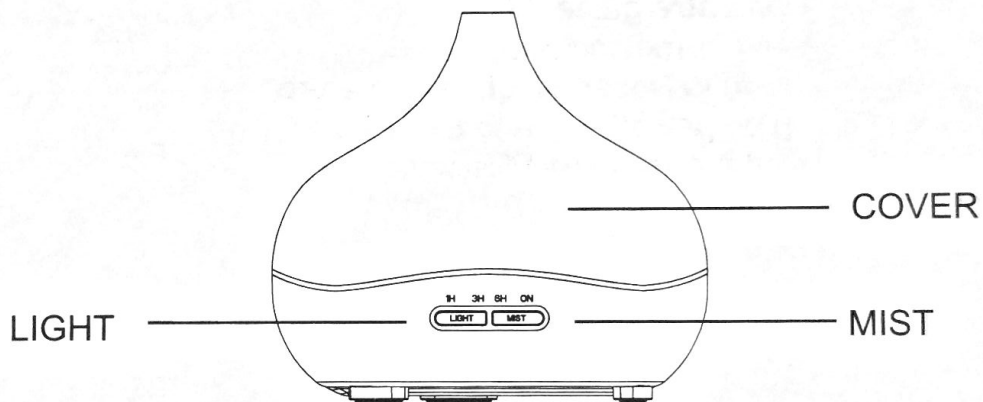

OPERATION

1. Keep product straighten, remove the cover vertical direction. **Fig1**
2. Please connect the AC adaptor to the base of DC jack of the main body via cable guide. **Fig2**
3. Please use the measure cup(not included in the package) to supply water(Do Not add high temperature water) from the water pipe,pay attention to the filled waterlevel;do not exceed the max line,Please do not add water when the product is working.Drop essential oil into water tank vertically.**Fig3**
4. Install the cover of the main body with the original channel, To fall to the vertical direction, Rotate the cover to adjust the desired position mouth spray. BTW:You must cover the upper cover when you want to use the product. **Fig4**
5. Please connect the AC adaptor with family user power supply socket.
6. Press "MIST" button,choose the time needed, (1H,3H, 6H or ON continuous spray time).Long press the "MIST" button shown the mist high and low (one sound B is high,sound B B is low).If you want to turn it off, please press "MIST" button five times (from 1H,3H,6H, ON to OFF).**Fig5**
7. Press "LIGHT" to turn on the light. Adjust the light intensity.(Strong / weak / Off).**Fig6**
8. If you do not use it for a long time, please drain out the water from tank water, dry and then keep it well. If you want to use it again, please use the neutral detergent to clean the water tank again, then you can use it.
9. When the power is switched on, the initial state of Aromatherapy machine is turned off.
10. If lack of water in the tank, even though the MIST switch, aromatherapy machine will automatically turn off.
11. Mist and light off automatically when water runs out.

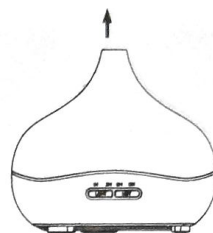

Fig1

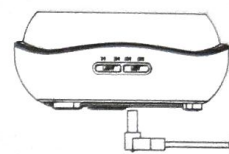

Fig2

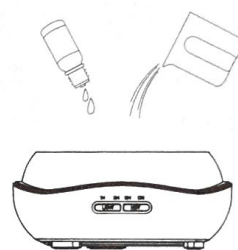

Fig3

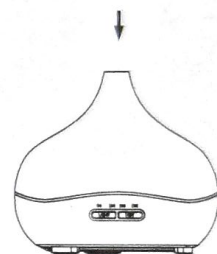

Fig4

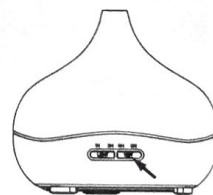

Fig5

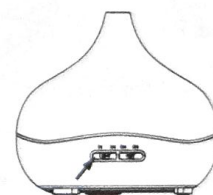

Fig6

PRECAUTIONS

- Product use time:6 hours for high mist, 10 hours for low mist.
- The amount and intensity of mist produced will vary, but this is not unusual and should not be considered as a fault.
- Factors that affect this include water type, humidity, temperature, air currents.
- Auto power off when water runs out.
- Applies only 100% natural essential oils, if they contain chemical ingredients, flavors or impurities may cause damage to the product.
- Before replacing another essential oils, follow the maintenance part of the clean-up products.

ACCIDENTAL LEKAGE

In the event of the unit being knocked over or tipped during use, please follow the steps as below to avoid malfunction:

1. plug the unit and remove cover.
2. pour out any remaining water from the water tank.
3. shake the unit gently to drain water, and then keep it natural air drying for at least 24 hours.

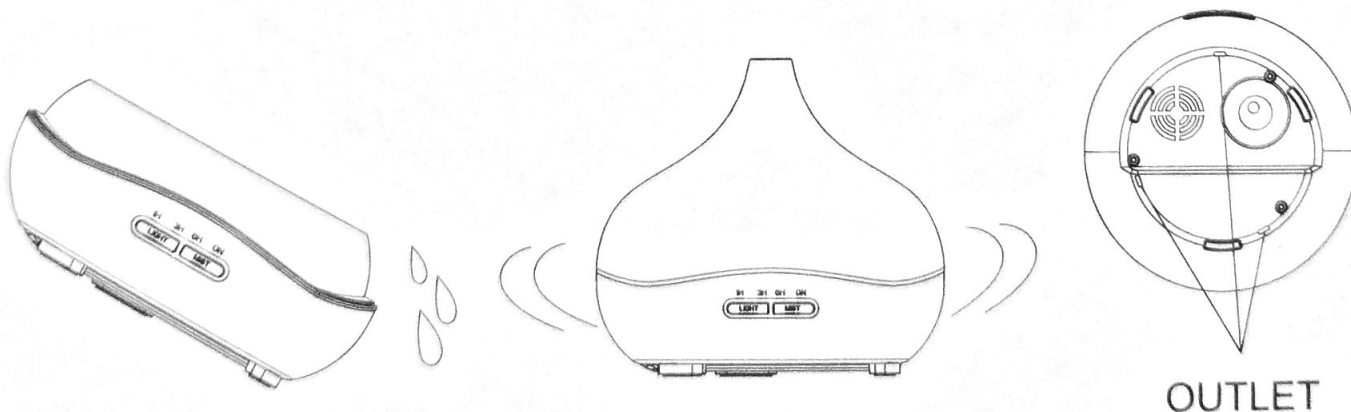

MAINTENANCE

After using 5-6 times, or 3-5 days, please clean the product as follow:

- 1.unplug the unit from mains supply and remove cover.
- 2.pour out any remaining water from the tank.
- 3.add a small amount of warm kitchen detergent remover and water,use swab to wipe it gently,and then use cleaning cloth to dry it lightiy.
- 4.refer to the following pictures, to avoid water flow into the air outlet,pour off water abide by the left picture, not the right one.
- 5.do not use other acids or enzymes detergents,as this may give off poisonous gas or cause malfunction.

Note: Be sure to use a mild detergent.

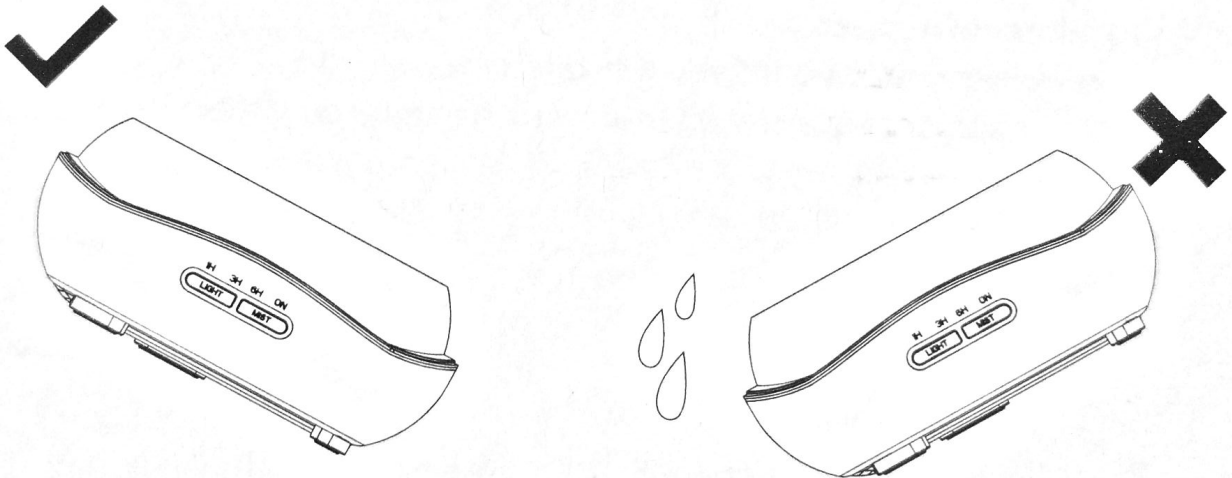

PRECAUTIONS

Please check below to avoid malfunction of the unit:

- Do not fill over 300ML"MAX" at any time.
- Do not switch on power when the tank is empty.
- Do not touch the Ultrasonic vibration plate.
- Clean regularly as per Maintenance instructions to avoid malfunction.
- Always unplug from power supply before maintenance.
- For hygiene reasons, after use, pour away remaining water from "DRAIN SIDE" of tank, and wipe with a clean dry cloth.
- Essential oils can stain, In the event of spillage of contact, please wipe away with a soft cloth.
- Only use the measuring cup (not provided) to add water into the tank, do not fill water directly from the water pipe.
- Do not let mist below onto furniture, clothing, walls etc.
- Keep away from directing sunshine heat sources and air conditioners or fans.
- Always keep on stable flat surface do not place on carpet, duvet or unstable area.
- Keep away from electronic equipment, such as TV and Auto equipment.
- Do not tip the product this may cause water to enter the mechanism and cause malfunction.
- Product use time:6 hours for high mist, 10 hours for low mist.
- Wait 60 minutes before restart to avoid damage to Ultrasonic plate.
- Use tap water only, does not use mineral water, sparkling water etc.
- Never move product in use.
- Do not touch any part of the product with wet hands.
- Keep out of reach of children and pets, Children not being supervised are suggested not play with the product. Appliance is not suitable for children or person with reduced physical, sensory or mental capabilities, or lack of experience and knowledge to be used, unless they have been given supervision or instruction.
- Keep cord clear of pathways, and do not pull forcefully at any point.
- If smoke or burning smell is detected, unplug immediately.

TROUBLESHOOTING

Please refer to the table below in the event of the product operating abnormally:

If product doesn't work well, please refer to the following points before requesting repairs:

Will not switch on or switch off	<ul style="list-style-type: none"> ● Is there enough water in the tank? --Please add water to the tank ● Is the power cord connected properly? --Please disconnect, check cables and re-connect carefully.
No mist or abnormal mist	<ul style="list-style-type: none"> ● Not enough water? or too much water? --Please add suitable amount of water in the tank, water must never be filled over 300ML (MAX)line. ● Dirt on the ultrasonic plate? --Please refer to maintenance instructions remove and re-install correctly, so vapors can be released freely. ● Cover and inner cover are not installed properly? Dirt on the air suction port on the underside of the base? --If too much dust in the air suction port, the mist will be restricted to come out. Just clean it.
Water leakage from product	<ul style="list-style-type: none"> ● Cover and inner are not installed properly? --Remove and reinstall correctly, so vapors can be released freely. ● Low temperature or high humidity? --Under these conditions, the mist may condense quickly into water droplets.

SPECIFICATIONS

Dimensions	Approx 168 x148MM
Weigh(excluding adaptor)	Approx 420g
Power: Input/Output	AC100-240V 50.60HZ / DC 24V 650MA
Length of cord	Approx 170CM
Electric consumption	Approx 14W
Time Mode	1H/3H/6H/ON
Tank Capacity	300ML
LED light	6pcs
Materials	PP/ABS/PC
Accessories	AC Adapter and manual
Method of mist production	2.4MHZ