

# AROMATECH

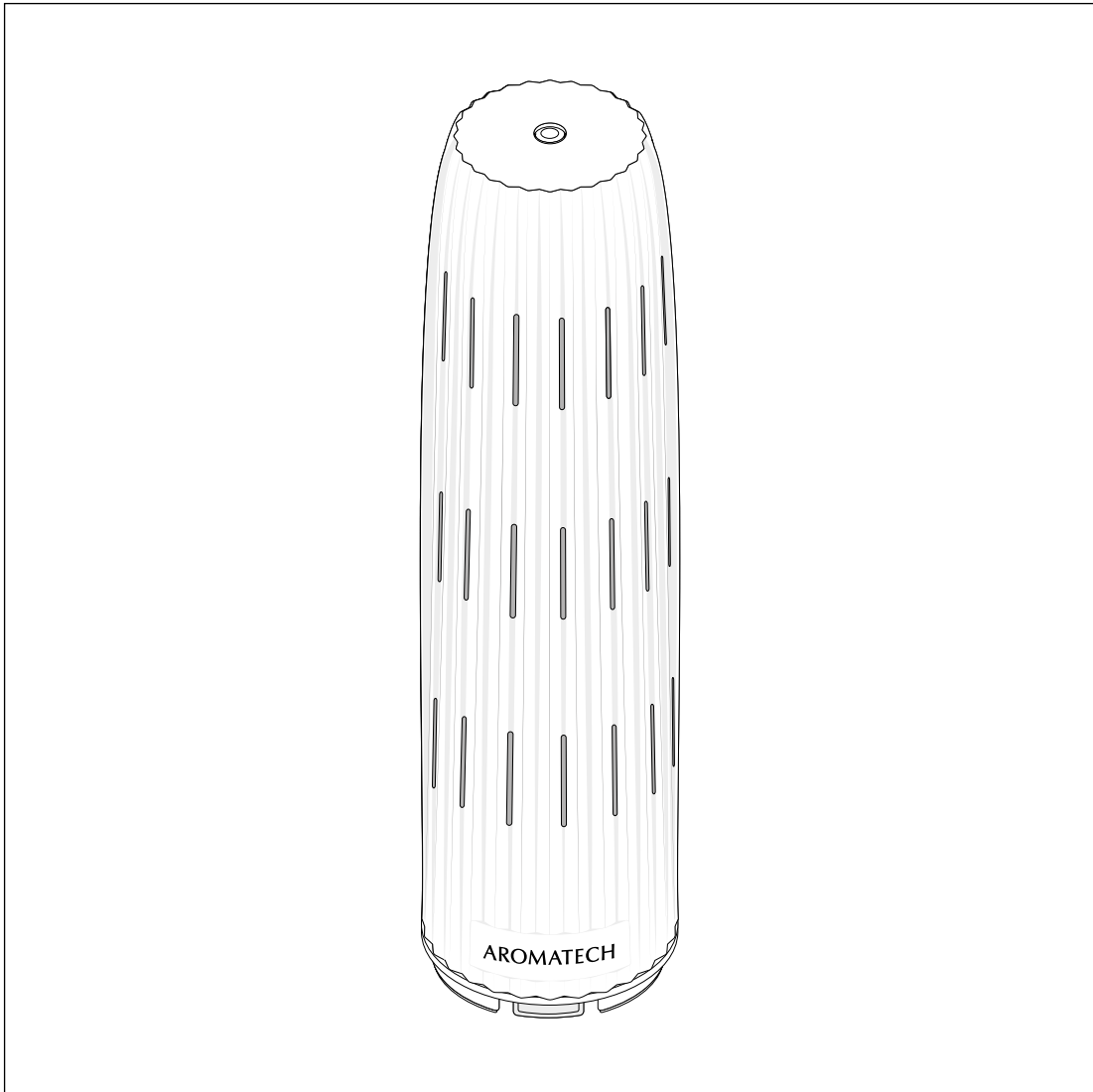

## Ambience

Welcome to

# AROMATECH



## **Pure scent — and nothing else.**

Our cold-air diffusers disperse scent using filtered air instead of water or heat. The result: a cleaner, more consistent scent experience.

## **Powerful.**

Our cold-air diffusers cover twice the square footage of ultrasonics or candles.

## **Consistent.**

Long-lasting fragrance is evenly distributed throughout your home.



# The Magic of Nebulization

## What is Cold-air Diffusion?

Cold-air diffusers disperse fragrance oils through nebulization—a process that breaks down scent oils into an ultrafine dry mist. The nanoparticles in this mist are so tiny that they remain suspended in the air for hours. This cutting-edge technology uses no water, alcohol or heat, diffusing scents in their purest form.

## Why is it Better?

Cold-air diffusers can cover spaces twice as large as typical candles, reed diffusers, plug-ins and ultrasonics. They're more consistent, ensuring fragrance is evenly distributed, and more precise, giving you the option to adjust the scent intensity. Our diffusers are cleaner because they neither dilute nor heat the scent oil.

## Cold-air Versus Ultrasonic

No water, no mold—our cold-air diffusers have a number of benefits over traditional ultrasonics. They're more powerful and use diffuser oils more efficiently, so your scents last longer. They're also far easier to use, you can go weeks between refills and no hands-on cleaning is required. In fact, a quick rinse with our cleaning solution is the only maintenance recommended.

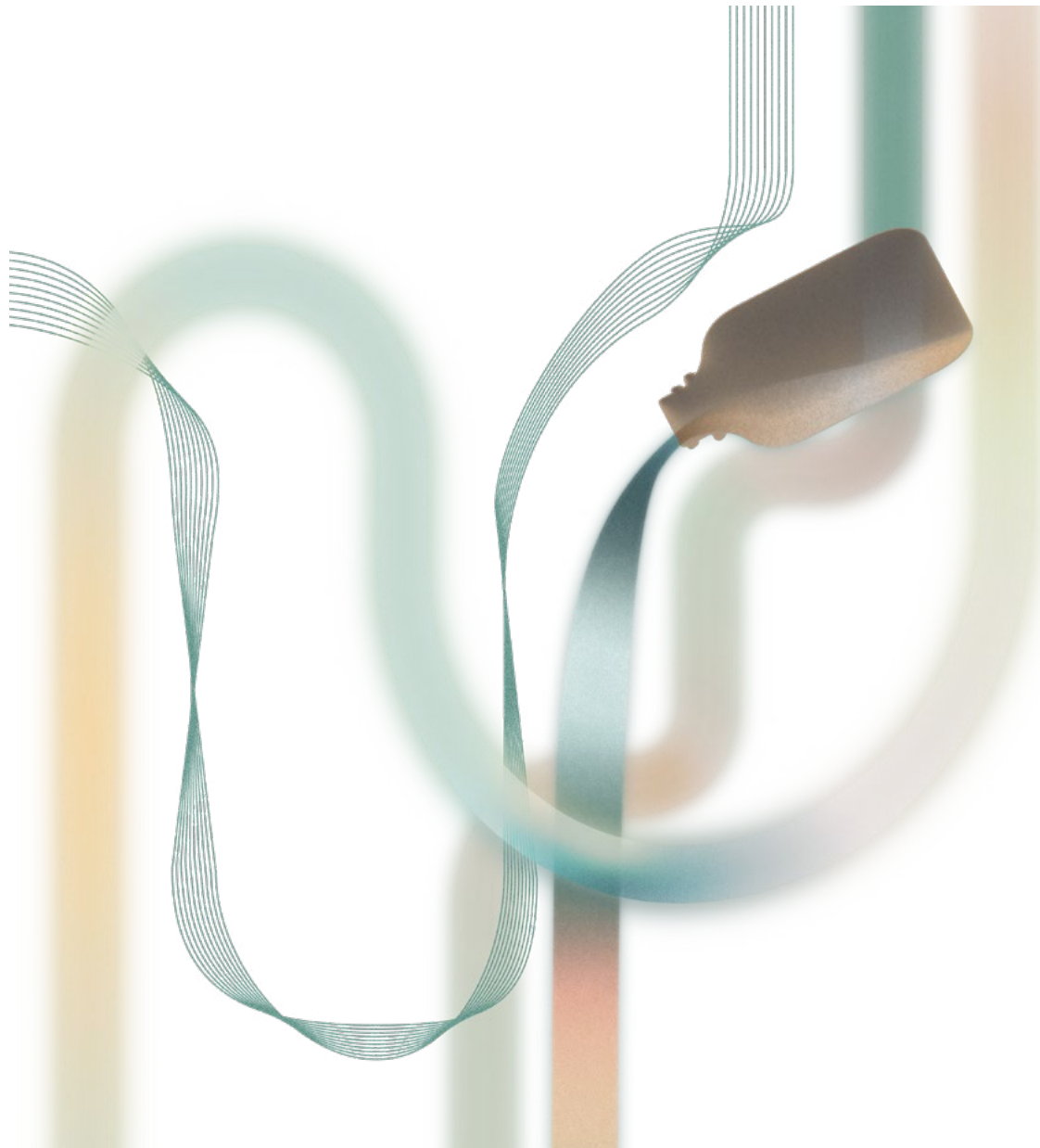

## **Our Ingredients**

We're very particular about what goes into our diffuser oils—and what stays out. To craft the safest, purest and most beautiful scents, we use a mix of safe synthetic and naturally derived ingredients. All of our diffuser oils are sustainably sourced and made in the U.S.

## **Our Safety Promise**

Our diffuser oils exceed the strict safety and environmental standards set by the International Fragrance Regulatory Association (IFRA), as well as the Volatile Organic Compound (VOC) guidelines set by the California Air Resources Board. They are entirely free of parabens, sulfates, synthetic colors and other harmful additives. Please note that our oils are for diffuser use only; do not use topically or ingest. Those with medical conditions should consult a health care practitioner prior to use.



# Contents

---

---

---

---

---

---

---

---

---

---

---

---

---

---

---

# Diagram of Parts

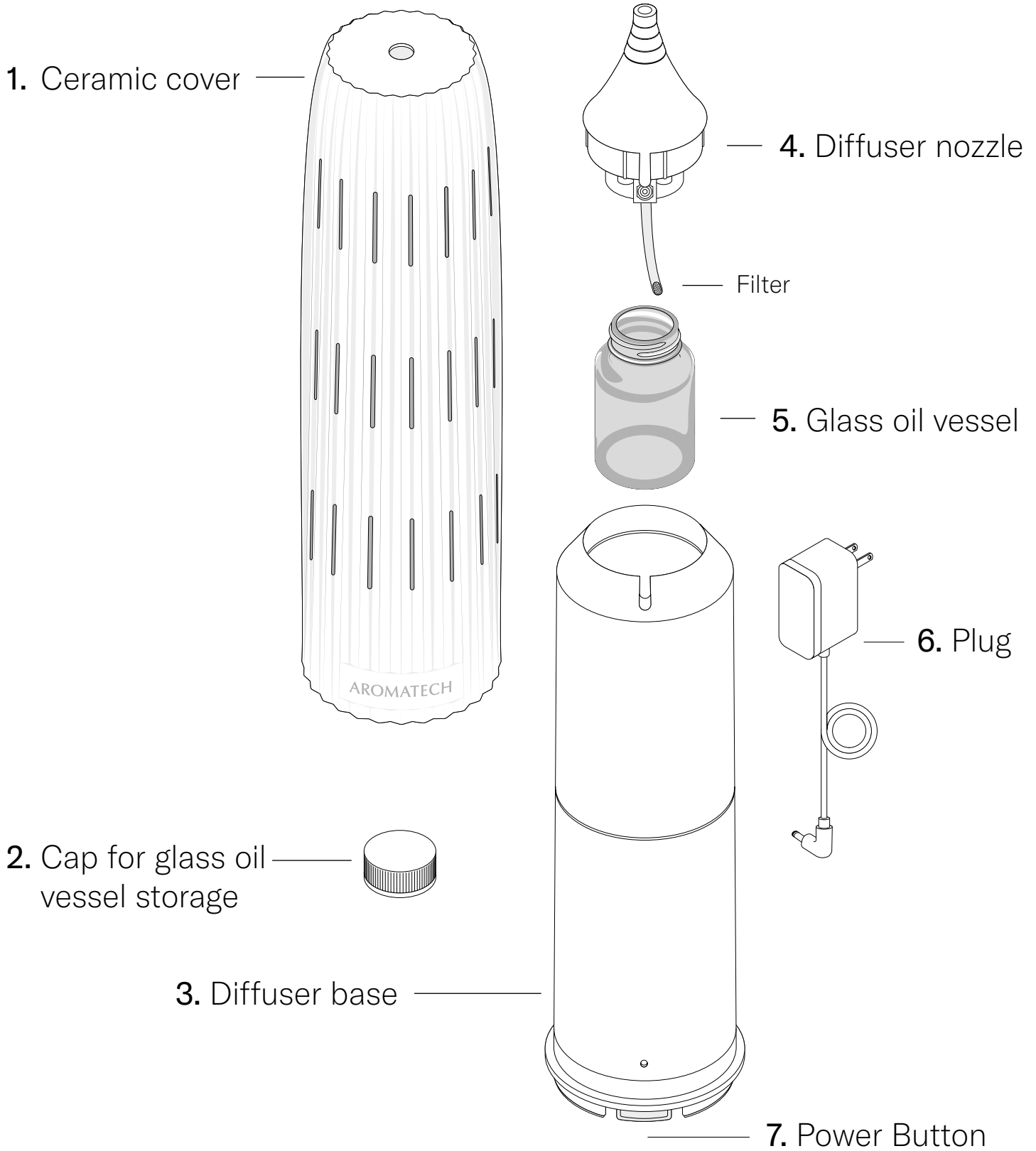

# Set-Up

## Step 1.

We've designed the Ambience to work best with the **AromaTech App**. Use the app to create a scenting schedule and personalize the intensity and ambient light.

Scan the QR code to download.



## Step 2.

Remove the ceramic cover.

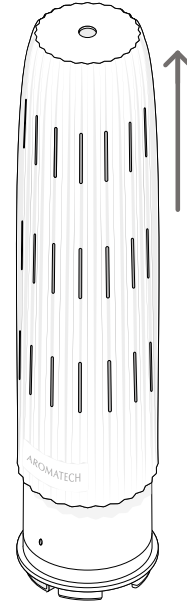

## Step 3.

Wiggle the diffuser nozzle back and forth while pulling up to reveal the glass oil vessel.

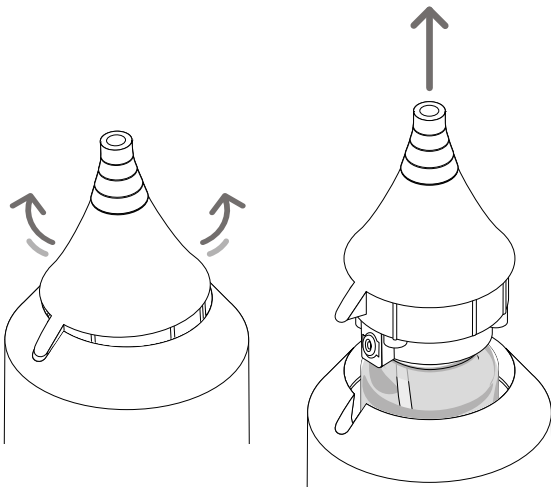

## Step 4.

Unscrew the glass oil vessel.

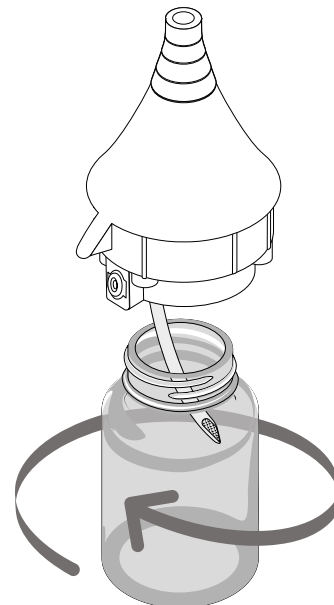



### Step 5.

Fill the glass oil vessel with AromaTech aroma oil.



*Note: Do not fill past the shoulder of the glass oil vessel.*

### Step 6.

Screw the glass oil vessel back into place, making sure it's secure.

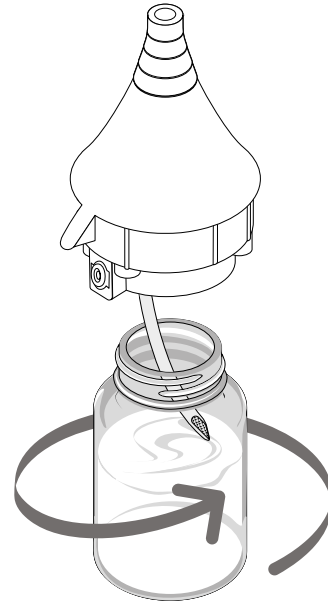

### Step 7.

Make sure that the notches on the diffuser nozzle and diffuser base match up. Push the diffuser nozzle back onto the diffuser base.

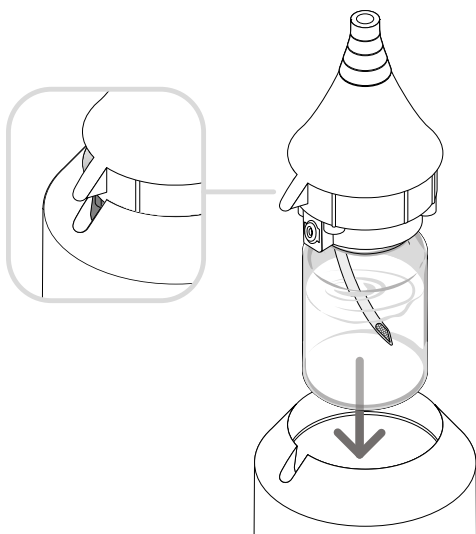

### Step 8.

Lower the ceramic cover back into place, making sure the nozzle and hole in the cover match. Also ensure the lower curve matches over the power input.

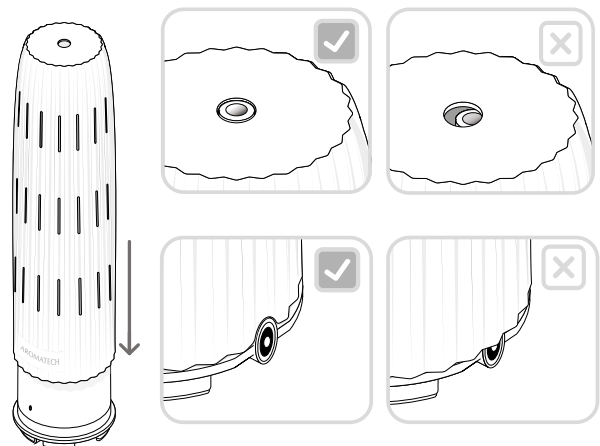

## Step 9.

Plug in your diffuser. It will immediately begin diffusing oil.

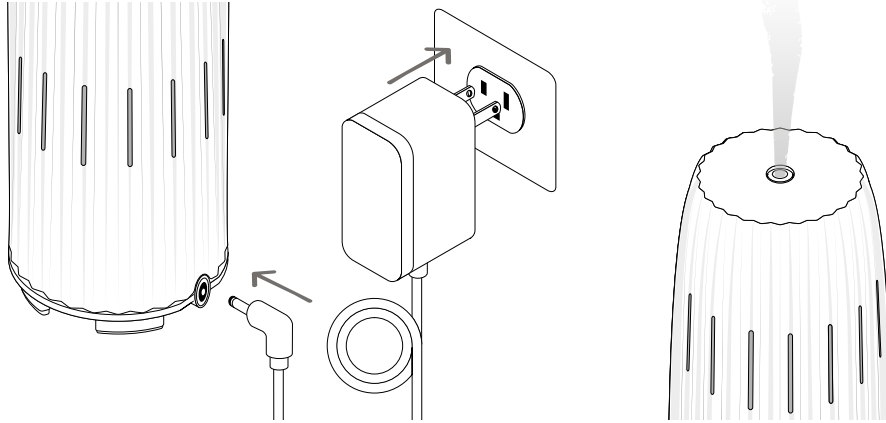

## Step 10.

When using your Ambience diffuser manually:

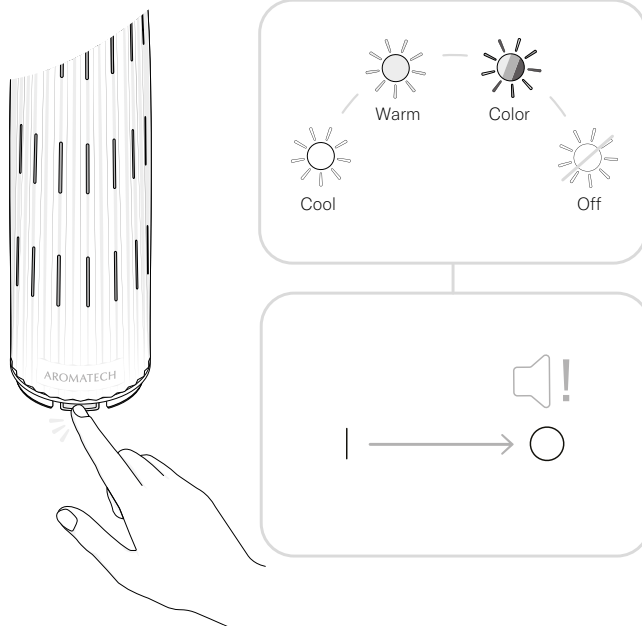

Cycle through each ambient light option by tapping the power button.

To manually stop/start diffusing oil, hold down the power button until you hear a long beep.

We recommend creating schedules and setting intensity levels in the **AromaTech App** to ensure your space is scented to your liking. You can set up to 5 schedules in the App. Our recommendation is that you create a schedule that matches your lifestyle or business needs so that the diffuser will only run when desired.

# Using the AromaTech App

For FAQs about AromaTech products in general, see: <https://aromatechscent.com/pages/faq>

## Step 1.

To start using your diffuser:

Download the AromaTech App from the Apple App Store (iOS).

Note: The AromaTech app is currently unavailable for Android devices.

Scan the QR code to download.

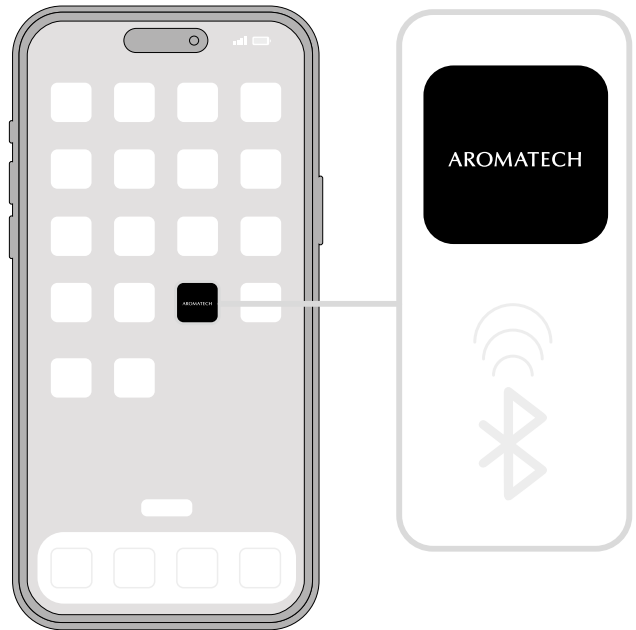

## Step 2.

Make sure your AromaTech diffuser is plugged in.

Note: Your AromaDream™ and Ambience diffusers will start to diffuse upon being plugged in and will continue to diffuse during setup.

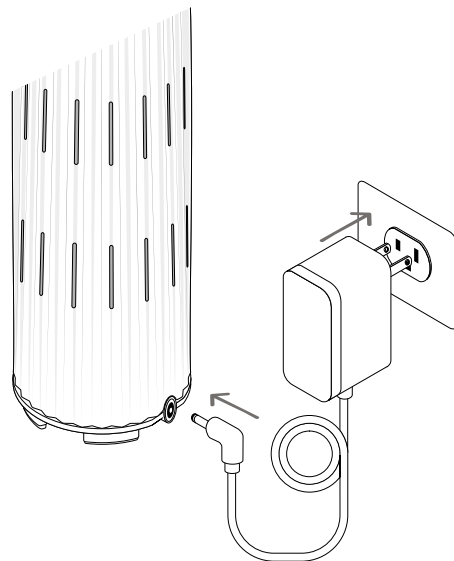



### Step 3.

Ensure Bluetooth is enabled on your phone.

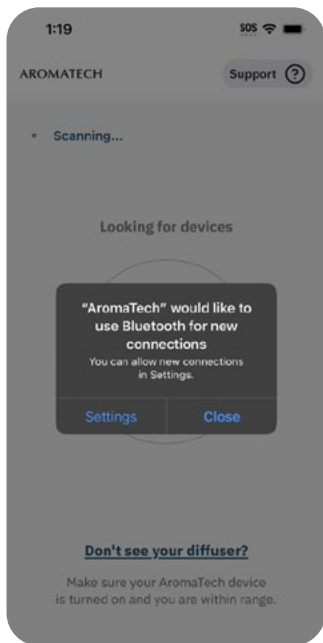

Open the AromaTech app. You will receive a prompt to allow Bluetooth permissions for the AromaTech app.

### Step 4.

On the Diffuser List screen, select the diffuser you would like to set up.

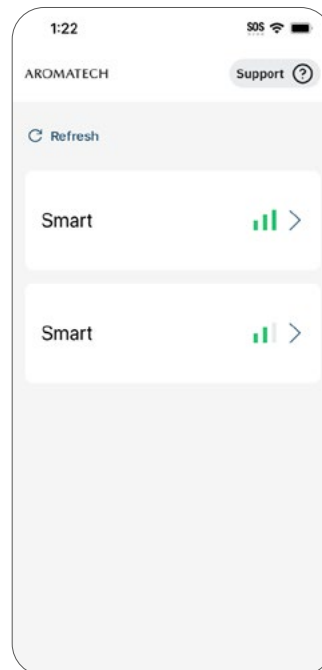

### Step 5.

After selecting the diffuser, continue to set up your schedule, lighting and intensity.

1. Selecting the edit icon beside the diffuser's name (default: "Smart")
2. Type in the desired name in the text box.  
Note: The maximum number of characters allowed is 13.
3. Click "Save" to save changes or "Leave without saving" to discard changes.

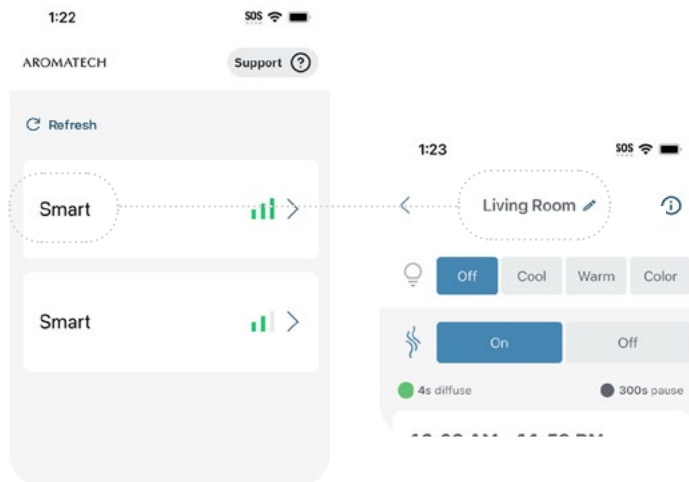

## Step 6.

Device naming tips:

- Name your diffuser based on its location to easily identify and adjust schedules when using multiple diffusers.
- Name your diffuser based on the scent you have diffusing. This ensures you remember what aroma oil you have placed in the bottle.

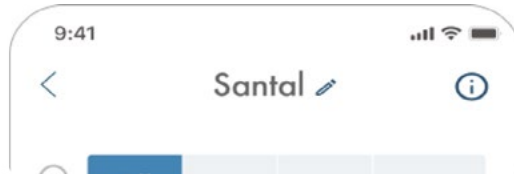
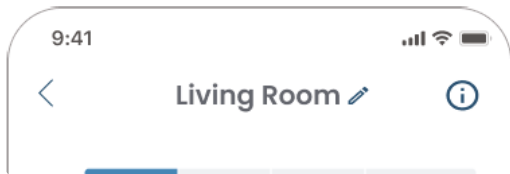

## Step 7.

Your AromaTech diffuser has 4 ambient light options: Off, Cool, Warm, and Color. To adjust the light option click on the setting you desire. You'll hear a beep and the button will turn blue indicating that the option has been selected.



## Step 8.

If you would like to turn off scent diffusion, tap the "Off" button in the Diffusion Control section. All schedules will be disabled and grayed out. You can continue to edit any of the five schedules.



## Step 9.

To restart scent diffusion tap the "On" button in the Diffusion Control section and ensure there are active schedules in the Manage Schedules section.

## Step 10.

Below the diffuser's On/Off button, you'll see five available schedules. The first is set by default to diffuse 24/7; the remaining four schedules are waiting for you to set. If all schedules are grayed out, you will need to set a schedule otherwise your diffuser will not run.

To adjust and turn on any of the schedules:

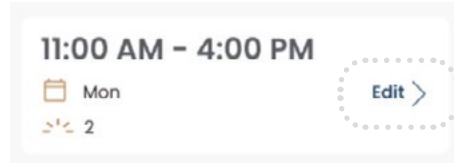
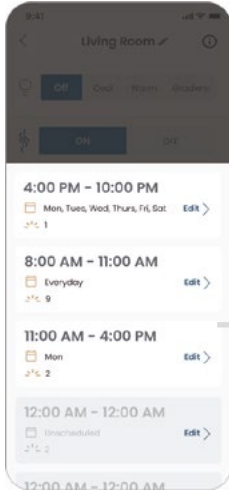

Click "Edit" in the schedule card you want to update.

Select the **days** for the scenting schedule.

Choose a desired start and end **time**.

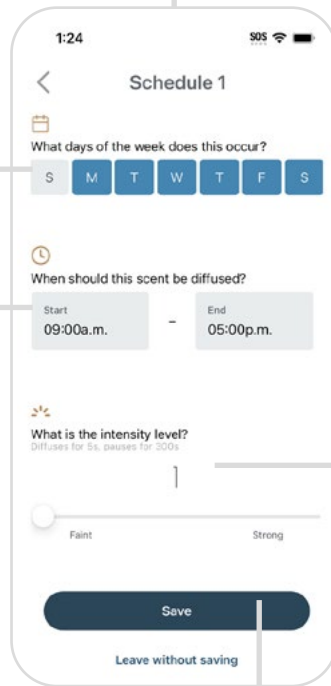

Set the diffusing **intensity level**. There are 5 intensity settings.

Intensity Setting	On	Off
1	5 sec	5 mins
2	10 sec	4 mins
3	10 sec	2 mins
4	15 sec	90 sec
5	25 sec	90 sec

**Save** your edits by clicking "Save". You'll return to the main diffuser page.

Continue editing each schedule until you've found the perfect set of schedules for your space and desired scenting experience.



# Where to Place



The placement of your diffuser is important in ensuring your space is optimally scented.

The ideal placement should work with the natural flow of air. It's important not to place your diffuser by an HVAC return grill, exhaust, fan, window or doorway as the scent will flow out of the room. Ensure that there's at least 3 feet of clearance above the diffuser so that nothing is blocking the air from passing over the diffuser and dispersing scent in the room. We recommend trying a variety of locations and settings until you are satisfied with the scent coverage.

Once you've chosen a good location for your diffuser it's time to find your preferred scent intensity level. The higher the intensity level, the more scent molecules are diffused into the air. Different scents may require a different intensity level. We recommend starting at a low-intensity level and then working your way up, until you've found a level that creates your optimal scenting experience.

Note: that a larger room or a room with high ceilings will likely require a higher scent intensity level.

Example of a 300 sq ft space for scent intensity versus ceiling heights.

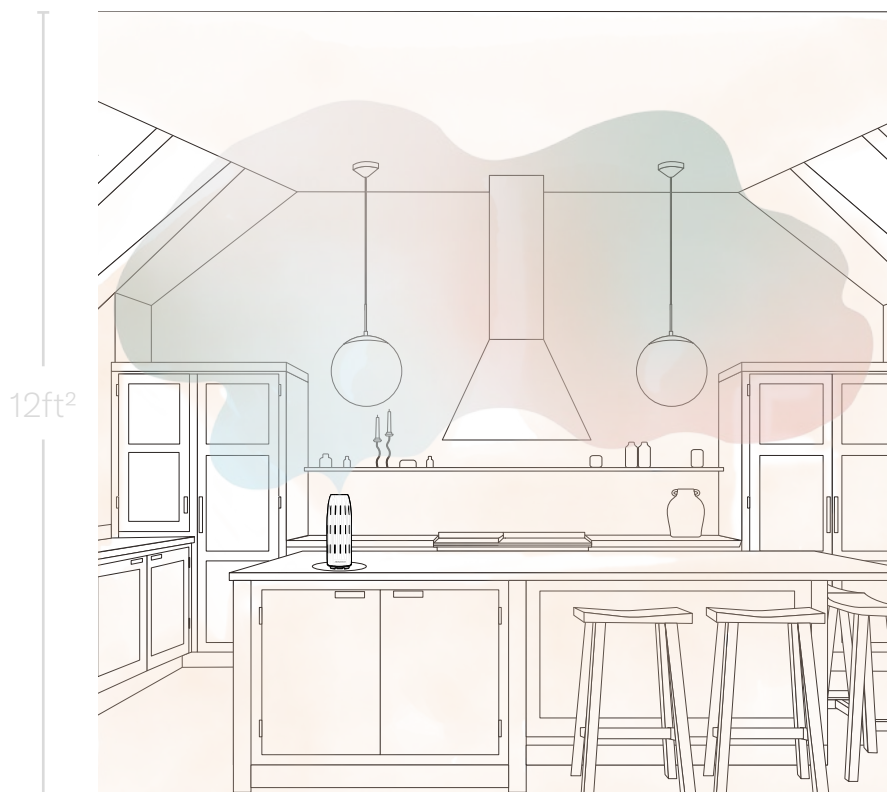

When you first use your diffuser it's important to let the scent disperse throughout the space. Refrain from changing the intensity level for about an hour.

Depending on the warmth of the room or if you change scents you might need to adjust the intensity level.

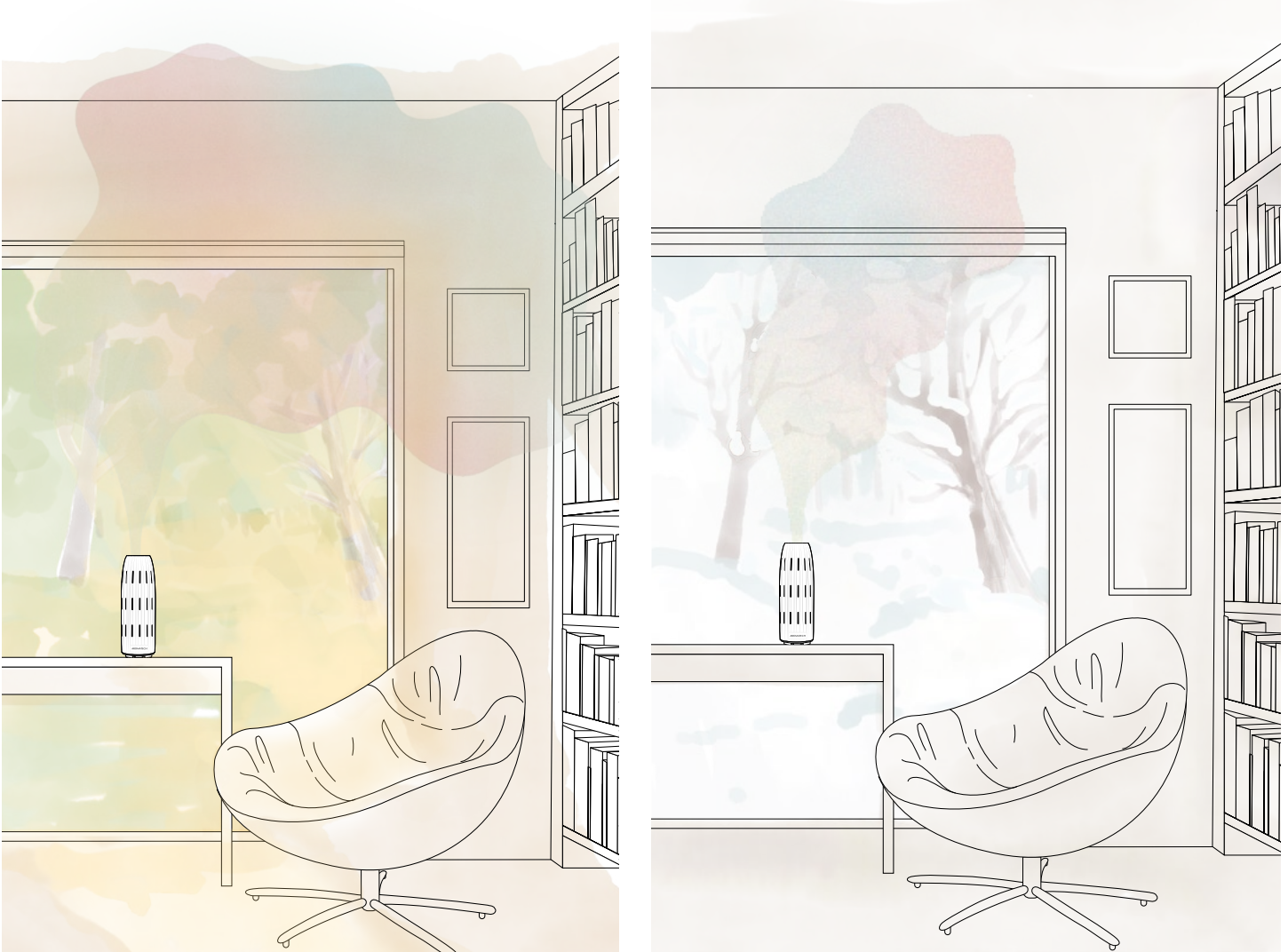

### Tips for finding the right location:

- Make sure the diffuser is on a flat, level surface and cannot be easily tipped over.
- Keep the diffuser out of reach of children and pets.
- Avoid getting aroma oil on wood or delicate surfaces. If oil drops occur on surfaces, clean with a damp cloth quickly to avoid leaving a ring or mark.
- Place your diffuser at least 2 feet off the ground.



# Scent Intensities & Schedules

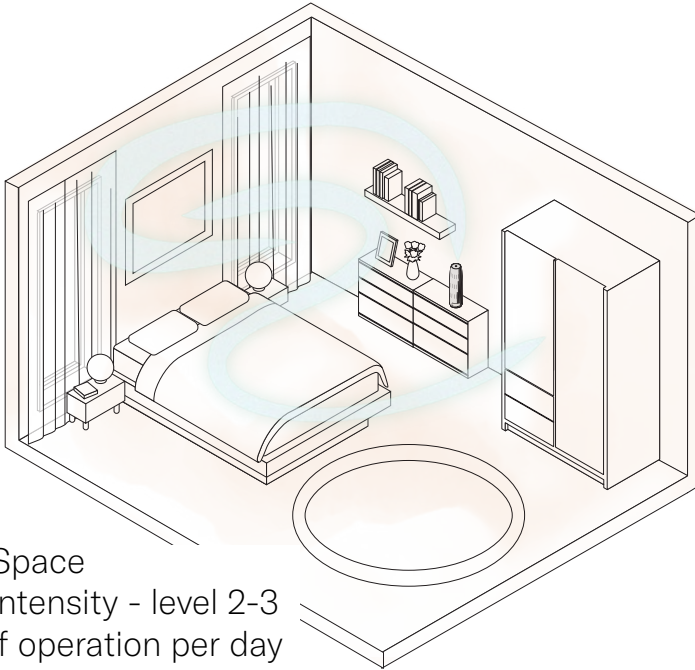

Medium Space  
Medium intensity - level 2-3  
4-8 hrs of operation per day

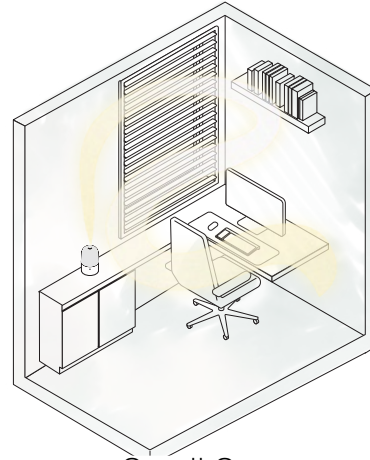

Small Space  
Low intensity - level 1  
4-8 hrs of operation per day

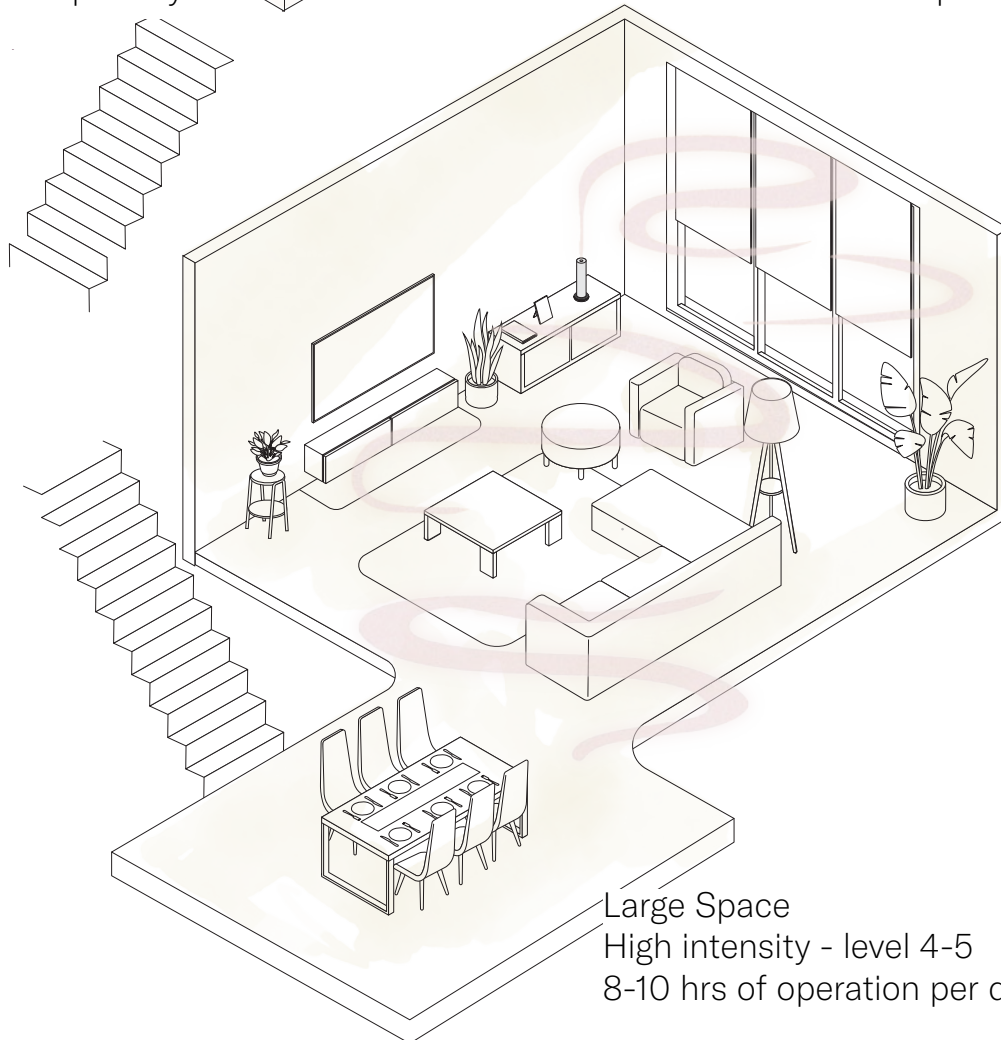

Large Space  
High intensity - level 4-5  
8-10 hrs of operation per day



Schedule the Ambience to welcome you home with your favorite scent.



# Scenting

Explore the possibilities of scenting by changing the scent you use. Choose a cozy scent for the weekend and an uplifting scent during the week. Mark a special occasion or a party by choosing a scent that's celebratory and fun.

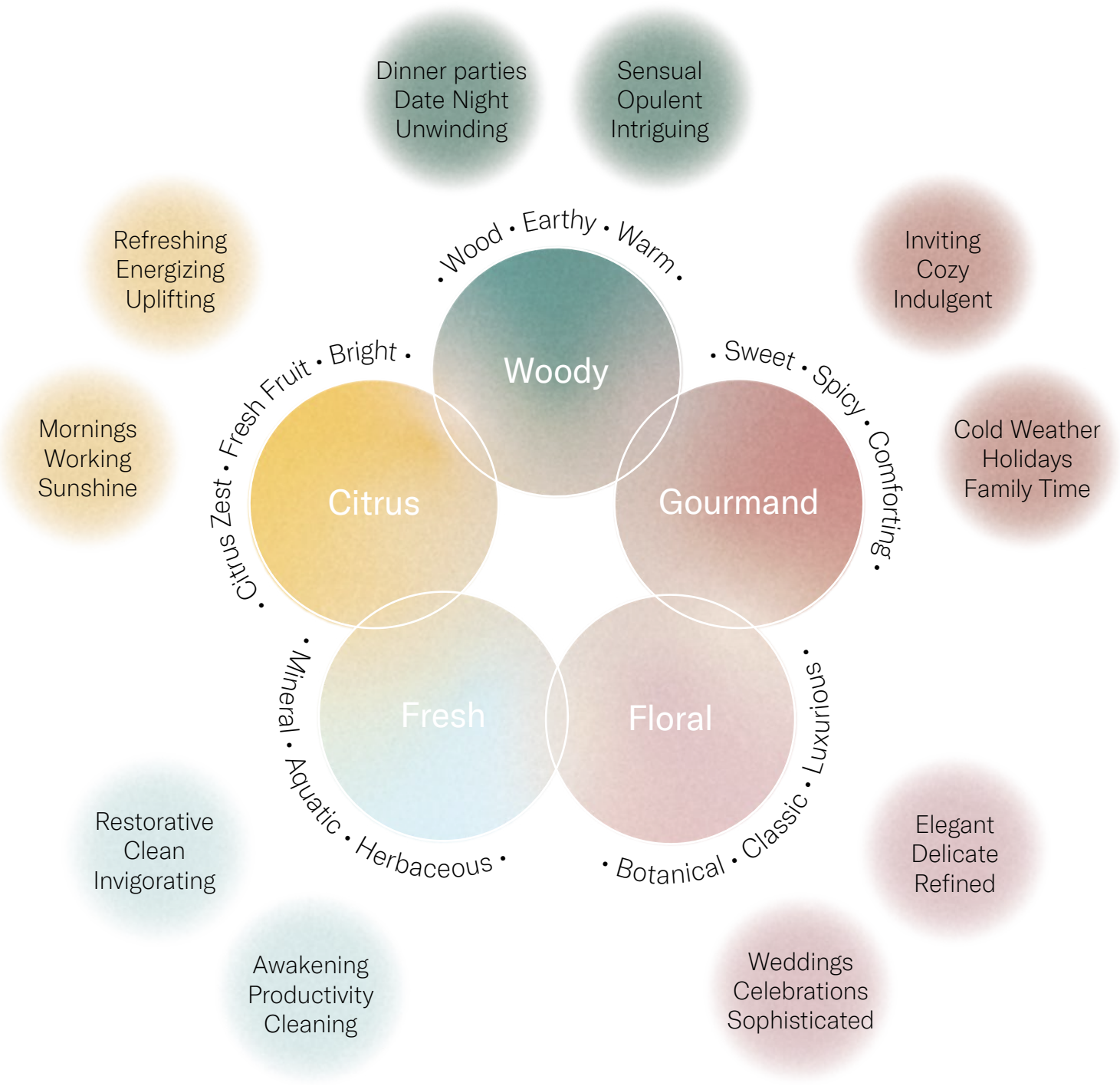

# Changing the Scent



Whether you like to redecorate your space to match the season or your mood, home scenting is a simpler and faster way to update your home or office.

When scenting for the season opt for a scent that invokes the spirit of each season. Choose a revitalizing scent that is fresh, floral, or tea-infused. For sun-drenched summer days, a fragrance that contains fresh citrus scents and hints of coconut and sea air is recommended. During the fall a scent that contains woody and gourmand notes can create a cozy atmosphere. Switch to a rich scent filled with vanilla, cinnamon or tonka bean that matches the festive energy through the winter.

You can even change your scent throughout the day. Choose an invigorating scent to encourage productivity and a relaxing scent for downtime. Choose a nostalgic scent for family time and a glamorous floral for celebrating. It's easy to see how refreshing your space is easy with home scenting.

# Maintenance

We recommend cleaning your diffuser every 1-2 months or when you change your oil.

1. Empty out any remaining oil in the glass oil vessel.

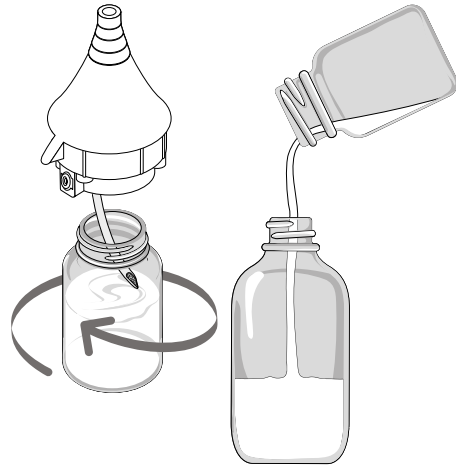

2. Pour in a quarter inch of AromaTech Diffuser Cleaner, reassemble the diffuser parts and run on the highest intensity setting for 15 minutes.

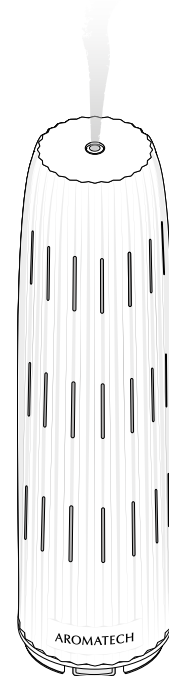
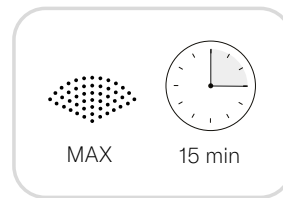
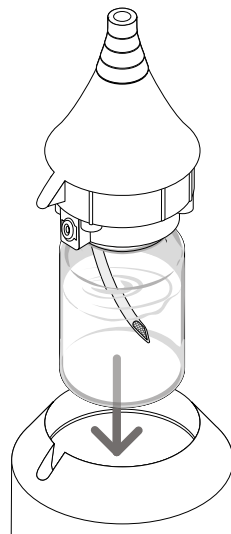

3. Discard the used diffuser cleaner, refill the glass oil vessel with your favorite scent and enjoy.



# Troubleshooting

How do I choose a different ambient lighting color? How do I turn off the ambient light?

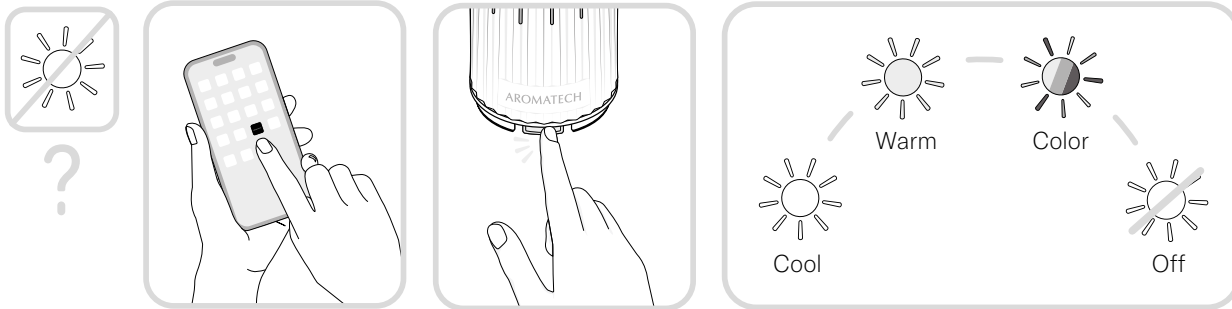

To choose a different ambient light in the App, connect your diffuser via Bluetooth to the **AromaTech App**, select which diffuser you'd like to adjust, then select the ambient light. You can choose between cool light, warm light, color light, or off.

To manually choose a different ambient light or turn the light off, press the power button to cycle through the options. You can choose between a variety of light settings.

**My diffuser is making a gurgling sound.**

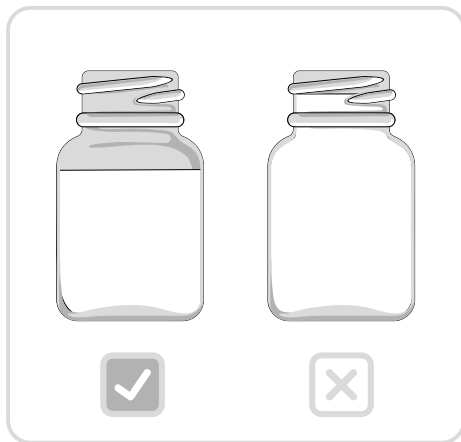

It's likely that you've overfilled the glass oil vessel. Simply pour out some of the oil in the glass oil vessel. Be sure to only fill to the shoulder of the vessel and not to the very top.

**The diffuser is making a noise but I can't smell anything and there is no nebulizing vapor.**

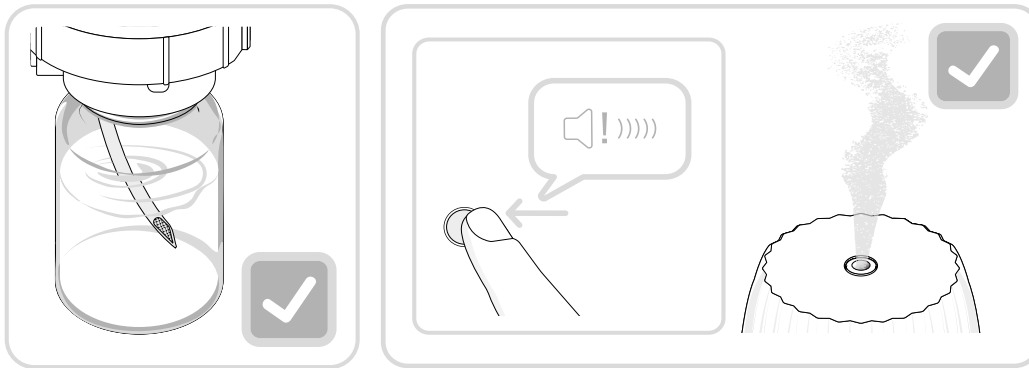

1. Please check that the diffuser's glass oil vessel has oil in it
2. If your diffuser was manually turned off, hold down the power button until you hear a long beep to turn it on.
3. If you're still unable to smell anything please reach out to the Client Experience team at [hello@aromatechscent.com](mailto:hello@aromatechscent.com).

**The oil in my diffuser looks cloudy.**

This is normal and will have no effect on diffusion. The nebulizer will aerate the oil in the bottle which might cause it to appear cloudy.

**I can't turn off my diffuser.**

To turn off your diffuser manually, hold down the power button until you hear a long beep.

**My diffuser's shell is dirty, how do I clean it?**

To remove smudges use dishwashing soap with water on a microfibre or soft cloth to wipe clean.

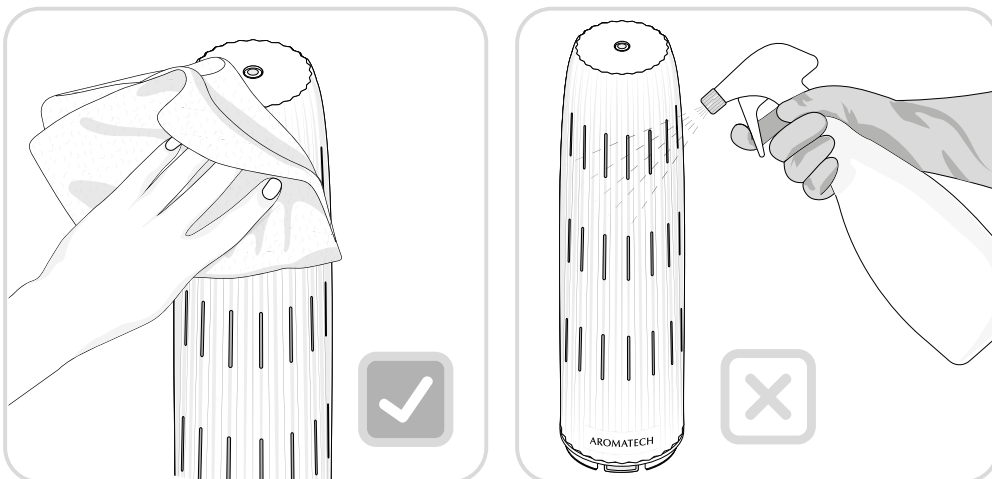

## Is there an Android app?

At this time our AromaTech app only works with iOS devices. An Android app is in the works, please sign up for our email list to ensure you are notified when the app is available.

You can still use your diffuser without connecting to the app. The default diffusion settings are level 3, 10 seconds on and 120 seconds off, the diffuser will run 24/7.

- To manually control lighting, press down the power button until you hear a short beep. The light will cycle through Cool, Warm, Color and Off modes with each press.
- To manually turn off diffusing, hold down the power button until you hear one long beep. Repeat this step to turn diffusing back on again.

## What are the differences between the Scenting app and the AromaTech app?

The Scenting app is compatible with our AroMini BT, AroMini Bluetooth Module, and AT-600. It will not work with your AromaDream™ or Ambience diffuser, please choose the AromaTech app.

While there are differences in the design of the Scenting and AromaTech apps both allow you to control how your space is scented.

## My diffuser beeps when I'm not controlling it.

The diffuser will beep whenever an AromaTech user connects to the diffuser with the app. You'll notice your diffuser also beeps when you make updates to the name or schedule, or change the light.

## Can I change the beeping sound that the diffuser makes when I change a setting?

Unfortunately at this time the factory setting beep is not able to be updated.

## What is an example of a typical fragrance schedule?

We suggest setting your schedule to run no longer than 8 hours when you're in your space. A typical home user will have at least 2 schedules:

- One set to turn on 30 minutes before waking up and end when leaving the home; and a second, evening schedule, set to turn on 30 minutes before returning home and end when going to bed. They may have additional schedules for the weekend, family time, a special evening or dinner party.
- A typical business would have schedules that will have the unit turning on 30 minutes before opening hours and turning off at the closing time.

## I see five schedules in my app.

Your diffuser has five schedules that can be edited. They are grayed out until you make adjustments to activate them. You cannot add more than five schedules or delete these possible schedules. You can disable a schedule; to do so uncheck all the days of the week on that schedule you want to disable and save these settings. You need at least one schedule to be active in order for your diffuser to diffuse scent.

## I can't make a new schedule on my diffuser.

AromaTech diffusers can store up to five schedules. You can only edit the pre-existing ones.

## My diffuser isn't following the schedule I set in the AromaTech App.

Please ensure that the schedules you've created don't overlap.

Please try resetting your diffuser by following these steps:





1. Unplug the diffuser (if plugged in).
2. Hold down the power button while connecting the plug.
3. Release the power button after you hear 5 short beeps.

## My diffuser schedules have changed.

The schedules in your app reflect the desired settings that the most recent person to connect and edit selected. It's likely that someone edited your original settings. Alternatively, a factory reset was performed and you'll need to adjust the settings.

## The diffuser turned itself off.

Our diffusers run on alternating scent-diffusing and resting cycles. The length of each cycle is determined by the intensity level.

<b>Intensity Setting</b>	<b>On</b>	<b>Off</b>
 1	5 sec	5 mins
 2	10 sec	4 mins
 3	10 sec	2 mins
 4	15 sec	90 sec
 5	25 sec	90 sec

## My diffuser is not diffusing.

- If you are using the app, make sure the “Diffuser Control” is set to “On.”
- If you ever connected to the app, make sure you have at least one schedule that is active and set to diffuse within the current time (day of the week, and start and end time). A schedule is active when it is not grayed out.
- If your diffuser is still not diffusing, try factory resetting it.

## I can't connect to my diffuser.

1. Ensure Bluetooth is enabled for both your phone and the app; check your phone settings.
2. Ensure no one else is controlling your diffuser.
3. Ensure you are near your diffuser.
4. Try resetting your diffuser by holding down the power button till you hear one long beep, then turning it back on by holding down the power button till you hear another long beep.
5. Try fully shutting down the app and reopening it.
6. Try factory resetting your diffuser (instructions below).

## How do I reset my diffuser?

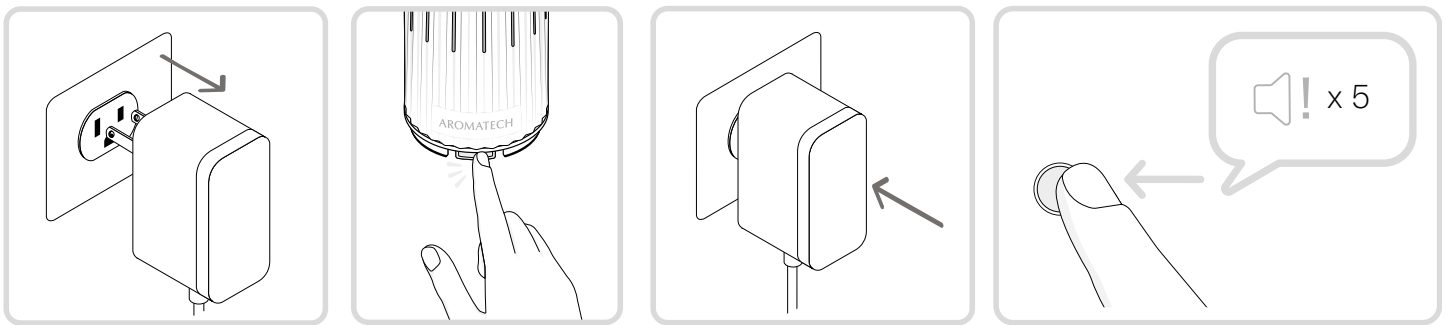

To reset your diffuser:

1. Unplug the diffuser (if plugged in).
2. Hold down the power button while connecting the plug.
3. Release the power button after you hear 5 short beeps.



# Warnings

Follow basic safety precautions when operating your AromaTech Diffuser.

- Do not tilt the device.
- Only use AromaTech aroma oils in the glass oil vessel.
- Never dilute AromaTech aroma oils with water or carrier oils.
- Keep the diffuser away from fire and heat sources.
- Only use the power adapter supplied with the device.
- Ensure the power adapter is never blocked when plugged in.
- Never operate the diffuser if the power adapter is damaged or wet.
- Never pour water in or on the diffuser and never operate with wet hands.
- Do not use the diffuser if any part of the device is broken.
- Never attempt to service, disassemble, or repair the device in any way.
- When moving the device always carry it securely with both hands, keeping it upright and ensuring it does not tilt.
- Always place the diffuser on a stable, level surface and ensure there is at least 3' clearance above the diffuser.
- Do not cover the device with objects or material while in use.
- Keep your nose clear from the scent output and the top of the diffuser when it is operating.
- Always keep out of reach of small children and pets.
- Store at room temperature 68-75 F (20-23 C), 30-35% humidity.

# Warranty & Support



All AromaTech designed diffusers come with a worry-free 1-year limited warranty from the date of purchase. This warranty includes ongoing support with your diffuser. If you have any questions or would like assistance with your diffuser please email us at [hello@aromatechscent.com](mailto:hello@aromatechscent.com) and we'll gladly assist you.

AromaTech is proud to offer repairs, including all labor and parts, necessary to ensure your diffuser is in proper working condition during the warranty period. Note that repairs and exchanges are at the discretion of the AromaTech team. We are here to support you, however, the warranty does not cover damages or repairs due to user error, or as a result of damage caused by third-party oils.

AromaTech is proud to offer repairs, including all labor and parts, necessary to ensure your diffuser is in proper working condition during the warranty period. Note that repairs and exchanges are at the discretion of the AromaTech team. We are here to support you, however, the warranty does not cover damages or repairs due to user error, or as a result of damage caused by third-party oils.

[hello@aromatechscent.com](mailto:hello@aromatechscent.com)  
1.888.276.6245

# Regulatory Information

## United States

This device complies with Part 15 of the FCC Rules.

Operation is subject to the following two conditions:

1. This device may not cause harmful interference, and
2. This device must accept any interference received, including interference that may cause undesired operation.

### FCC Warning

Changes or modifications not expressly approved by the party responsible for compliance could void the user's authority to operate the equipment.

Note: This equipment has been tested and found to comply with the limits for a Class B digital device, pursuant to part 15 of the FCC Rules. These limits are designed to provide reasonable protection against harmful interference in a residential installation. This equipment generates, uses and can radiate radio frequency energy and, if not installed and used in accordance with the instructions, may cause harmful interference to radio communications. However, there is no guarantee that interference will not occur in a particular installation. If this equipment does cause harmful interference to radio or television reception, which can be determined by turning the equipment off and on, the user is encouraged to try to correct the interference by one or more of the following measures

- Reorient or relocate the receiving antenna.
- Increase the separation between the equipment and receiver.
- Connect the equipment into an outlet on a circuit different from that to which the receiver is connected.
- Consult the dealer or an experienced radio/TV technician for help.

### Radiation Exposure Statement

This product complies with the FCC portable RF exposure limit set forth for an uncontrolled environment and is safe for intended operation as described in this manual. Further RF exposure reduction can be achieved if the product can be kept as far as possible from the user body or set the device to lower output power if such function is available.

## Canada

This device contains licence-exempt transmitter(s)/receiver(s) that comply with Innovation, Science and Economic Development Canada's licence-exempt RSS(s).

Operation is subject to the following two conditions:

1. This device may not cause interference;
2. This device must accept any interference, including interference that may cause undesired operation of the device.

The digital apparatus complies with Canadian CAN ICES-3 (B)/NMB-3(B).

### Radiation Exposure Statement

This device meets the exemption from the routine evaluation limits in section 2.5 of RSS 102 and compliance with RSS 102 RF exposure, users can obtain Canadian information on RF exposure and compliance. This equipment complies with Canada radiation exposure limits set forth for an uncontrolled environment. This equipment should be installed and operated with a minimum distance of 20 cm between the radiator and your body.

Cet appareil contient des émetteurs/récepteurs exempts de licence qui sont conformes aux RSS exemptés de licence d'Innovation, Sciences et Développement économique Canada.

L'exploitation est soumise aux deux conditions suivantes:

- Cet appareil ne doit pas provoquer d'interférences;
- Cet appareil doit accepter toute interférence, y compris les interférences susceptibles de provoquer un fonctionnement indésirable de l'appareil.

l'appareil numérique du ciem conforme canadien peut CAN ICES-3 (B)/NMB-3(B).

### Déclaration d'exposition aux radiations

Cet appareil est conforme à l'exemption des limites d'évaluation courante dans la section 2.5 du cnr - 102 et conformité avec rss 102 de l'exposition aux rf, les utilisateurs peuvent obtenir des données canadiennes sur l'exposition aux champs rf et la conformité. Cet équipement est conforme aux limites d'exposition aux rayonnements du Canada établies pour un environnement non contrôlé. Cet équipement doit être installé et utilisé à une distance minimale de 20 cm entre le radiateur et votre corps.

# AROMATECH

aromatechscent.com  
Toll Free: 1-888-276-6245  
Int: 1-602-698-9696  
hello@aromatechscent.com

1202 N. 54th Avenue, #105  
Phoenix, AZ 85043

© 2023 AromaTech Inc.