



Ts2 Clock Multi-Sync Gateway

USER GUIDE

SJC-DEV7250-HR

Copyright

Copyright © 2020 TesCom All rights reserved. No part of this document may be reproduced or translated into any language by any means without the written permission of TesCom. Throughout this document TesCom will be referred to as TesCom.

Disclaimer

TesCom makes no warranties for the contents of this document or the accuracy or completeness thereof and disclaims any implied warranties of merchantability or fitness for any particular purpose. Further, TesCom reserves the right to revise this document and to make changes without notifications to any person of such changes. The information contained in this document is provided solely for use in connection with TesCom products. This document should not be construed as transferring or granting a license to any intellectual property rights, neither expressed nor implied.

TesCom products have not been designed, tested, or manufactured for use in any application where failure, malfunction, or inaccuracy carries a risk of death, bodily injury, or damage to tangible property, including, but not limited to, use in factory control systems, medical devices or facilities, nuclear facilities, aircraft, watercraft or automobile navigation or communication, emergency systems, or other applications with a similar degree of potential hazard.

Table of Contents

| | | |
|-----|---|----|
| 1 | Introduction | 7 |
| 1.1 | Functional Overview | 7 |
| 1.2 | Interfaces..... | 7 |
| 1.3 | Typical Applications..... | 8 |
| 1.4 | Oscillator Options..... | 8 |
| 1.5 | PTP Slave Capacity | 8 |
| 1.6 | Components Block Diagram | 8 |
| 2 | Installation..... | 10 |
| 2.1 | Security Recommendations | 10 |
| 2.2 | Environmental Requirements..... | 10 |
| 2.3 | Packaging List and Unpacking..... | 10 |
| 2.4 | Rack Mounting the Ts2..... | 10 |
| 2.5 | Power and Ground Connections | 11 |
| 2.6 | Input / Output Signal Connections..... | 11 |
| 2.7 | Connecting GNSS Antenna | 12 |
| 2.8 | Applying Power..... | 12 |
| 3 | Getting Started | 13 |
| 3.1 | Logging in with the console | 13 |
| 3.2 | Set up IP address..... | 13 |
| 3.3 | Remote Network Access to Ts2 | 13 |
| 4 | Command Reference | 15 |
| 4.1 | Ts2 Basic Commands..... | 15 |
| 4.2 | Show commands..... | 16 |
| 4.3 | Inventory commands | 16 |
| 4.4 | Network Commands | 17 |
| 4.5 | HTTPS Restore command | 19 |
| 4.6 | Date command | 19 |
| 4.7 | Reboot command..... | 20 |
| 5 | Troubleshooting and Safety Considerations | 21 |
| 5.1 | Troubleshooting..... | 21 |
| 5.2 | Safety Considerations..... | 25 |
| 6 | Managed Clock Engine Overview | 26 |

| | | |
|------|---|----|
| 6.1 | Ts2 Engine Modes | 26 |
| 6.2 | GNSS Interface | 27 |
| 6.3 | Ts2 Clock Sync States | 27 |
| 6.4 | Unicast Operations..... | 28 |
| 6.5 | Gateway and Boundary clock | 29 |
| 6.6 | PTP Servo Configuration Parameters | 30 |
| 6.7 | Synchronous Ethernet (SyncE)..... | 31 |
| 7 | Physical Interfaces | 35 |
| 7.1 | Antenna input | 35 |
| 7.2 | Console..... | 35 |
| 7.3 | Hard Reset Button..... | 35 |
| 7.4 | Management interface..... | 35 |
| 7.5 | Frequency Out port..... | 35 |
| 7.6 | 1PPS timing output | 35 |
| 7.7 | Time-of-Day / 1PPS input/output | 35 |
| 7.8 | PTP interface, Port 1 and Port 2..... | 36 |
| 7.9 | LED Description | 37 |
| 7.10 | Power | 37 |
| 7.11 | Physical dimensions | 37 |
| 8 | End User License Agreement (2020 - 2021)..... | 38 |
| 9 | Part Numbers | 40 |
| 10 | Glossary..... | 41 |
| 11 | References..... | 43 |
| 12 | Contact..... | 44 |

List of Figures

| | |
|--|----|
| Figure 1 The Ts2 | 7 |
| Figure 2 The Ts2 Front Panel..... | 7 |
| Figure 3 The Ts2 Rear Panel..... | 8 |
| Figure 4 Ts2 Components Block Diagram | 9 |
| Figure 5 Help Command | 15 |
| Figure 6 History Command | 15 |
| Figure 7 Show Alarms Command | 16 |
| Figure 8 Show Status Command | 16 |
| Figure 9 System Info Command | 17 |
| Figure 10 System Upgrade Status Command..... | 17 |
| Figure 11 System Upgrade Start Command..... | 17 |
| Figure 12 Network Configure Command | 18 |
| Figure 13 Network Status Command | 18 |
| Figure 14 Network Ping Command | 19 |
| Figure 15 HTTPS Restore command | 19 |
| Figure 16 Gateway Clock (GC) vs. Boundary Clock (BC) | 30 |
| Figure 17 SyncE OFF | 32 |
| Figure 18 SyncE in Master Mode..... | 32 |
| Figure 19 SyncE in BC mode for G8275.1, ref input on Port-1..... | 33 |
| Figure 20 SyncE in BC mode for G8275.1, ref input on Port-2..... | 33 |
| Figure 21 SyncE in BC mode for G8275.2, ref input on Port-1..... | 34 |
| Figure 22 SyncE in BC mode for G8275.2, ref input on Port-2..... | 34 |

List of Tables

Table 1 Ts2 Rear Panel Interfaces 8

1 Introduction

1.1 Functional Overview

The Ts2 is a small form factor, highly accurate Multi-Sync Gateway that provides IEEE 1588-2008 PTP Grand Master and Boundary Clock functionality. IEEE 1588-2008 PTP is also known as PTP Version 2.



Figure 1 The Ts2

Ts2 gets its time from the built-in GNSS receiver or 1PPS/ToD input or IEEE 1588-2008 PTP as input references. PTP algorithms are leveraged to deliver stringent timing for frequency and phase profiles. Outputs include IEEE 1588-2008 PTP, selectable FREQ Out, 1PPS, and Time of Day (ToD). Ts2 will provide holdover depending on the chosen built-in oscillator.

Remote control and monitoring are provided over SSH, Web Interface and SNMP (v2, v3).

1.2 Interfaces

Ts2 Interfaces are shown in Figure 2 and Figure 3 along with a brief description of them in the tables below them. Detailed description of the interfaces is provided in the REF section of this User Guide.

Figure 3 along with a

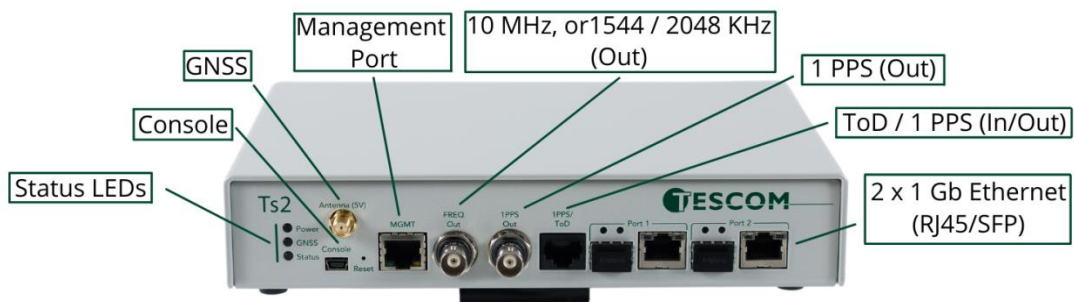

Figure 2 The Ts2 Front Panel



Figure 3 The Ts2 Rear Panel

Rear Panel Description

Ground connector

Primary power plug, 34 – 60 VDC / 28 – 40 VAC

Secondary power plug, 34 – 60 VDC / 28 – 40 VAC

Table 1 Ts2 Rear Panel Interfaces

1.3 Typical Applications

Ts2 is a small form factor IEEE-1588-2008 PTP Edge Grand Master and Boundary Clock that can be used for smart grid transmission and distribution substations. This Multi-Sync Gateway platform is designed for small cell clusters, C-RAN, and edge applications. For more information about PTP, see [1].

1.4 Oscillator Options

Standard: OCXO oscillator, 4-hour holdover for 1.5 μ sec accuracy.

Superior: Super OCXO oscillator, 8-hour holdover for 1.5 μ sec accuracy.

1.5 PTP Slave Capacity

The Ts2 has variants that can support different unicast slave capacity (32, 128, 256, ..) slaves at up to 128 sync / delay packets per second when the MCE is operated as a master clock depending on the product SKU. The variants are configured at the factory and cannot be field upgraded at present. Contact information for ordering the Ts2 with the supportable slave capacities is presented in the Contact Section of this User Guide on page 44. Section 8 of this User Guide presents all the variants available.

1.6 Components Block Diagram

The following block diagram defines the main components of the Ts2 system along with the physical connections to each component.

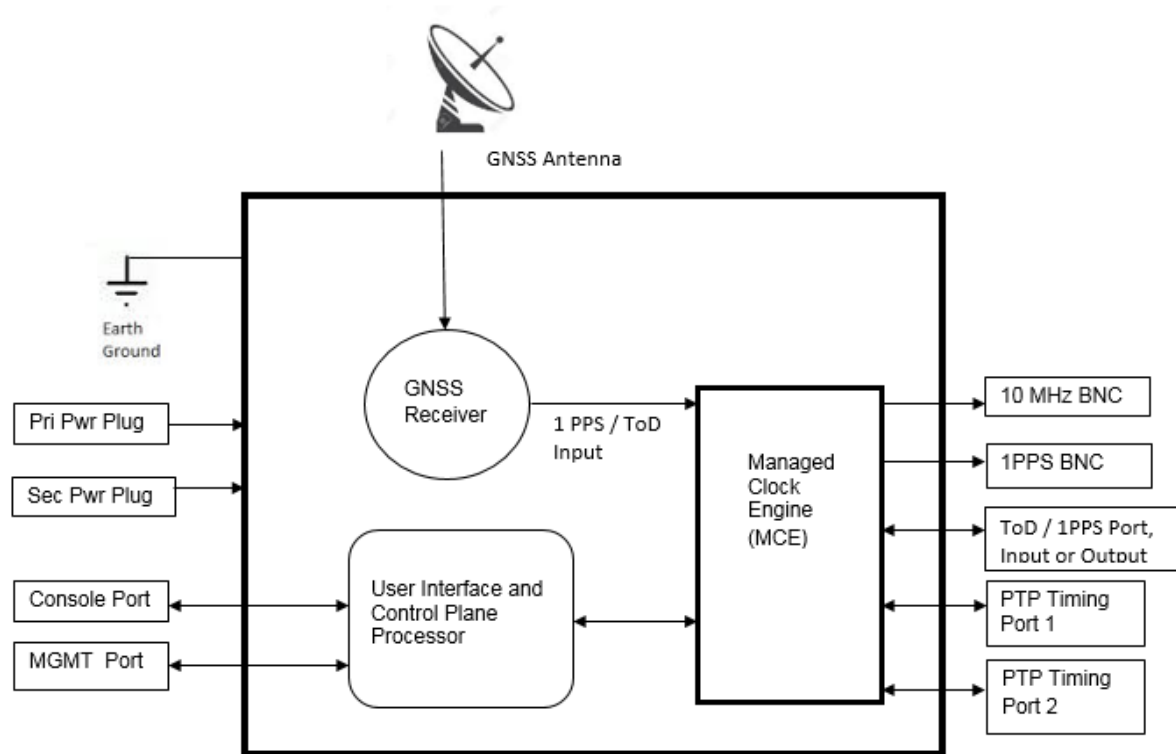

Figure 4 Ts2 Components Block Diagram

- Managed Clock Engine (MCE) is a full packet network-based synchronization engine supporting IEEE 1588-2008 Precise Time Protocol. The MCE is where IEEE 1588-2008 PTP packet communication processing runs, and port / BNC provisioning is applied. GNSS signals and User Interface Processor (UIP) commands are sent to the MCE.
- User Interface and Control Plane Processor, which supports all the user access and connectivity to the entire system. The Processor supports DHCP, HTTP webpage/CLI access, SSH, SFTP, XML and SNMP (v2, v3).
- GNSS Receiver – GPS Receiver combined with either a Beidou or Glonass or Galileo Receiver with external antenna input. The selection of the constellation is user configurable.

2 Installation

Before the Ts2 is installed, review the information in this section. If difficulties are encountered during the installation process, contact TesCom Customer Support, with the contact information provided in the Contact Section of this User Guide.

2.1 Security Recommendations

The Ts2 Management port and PTP Timing ports should be installed behind the company's firewall to prevent public access. Additionally, the PTP Timing ports should be connected to a Local Area Network (LAN) or Wide Area Network (WAN) dedicated to transporting PTP timing messages.

2.2 Environmental Requirements

The Ts2 operating temperature is 0°C to 50° C (-32°F to 122° F). Use only shielded cable for all signal wiring, including I/O, clocks and Ethernet. Use the Ground connector to appropriately ground the Ts2 to earth ground.

2.3 Packaging List and Unpacking

The Ts2 box contains the following:

- The Ts2 Multi-Sync Gateway
- 48V DC power adapter

GNSS antenna, mounting bracket and console cable can optionally be supplied by the local distributor.

The Ts2 is packaged to be protected from normal shock, vibration, and handling damage during shipment. Unpack and inspect the box contents as follows:

1. Wear a properly grounded protective wrist strap or suitable ESD protection.
2. Inspect the shipping box for signs of damage. If the box appears to be damaged, notify both the carrier and your TesCom distributor. Retain the shipping box and packaging material for the carrier to inspect.
3. Open the box, being careful to cut only the packaging tape.
4. Locate and save the printed packaging list and paperwork that is included in the box.
5. Remove the Ts2 from the box and place the unit on an anti-static surface.
6. Locate and set aside additional parts which may be contained in the box.
7. Remove and dispose of the anti-static packaging from the Ts2 and parts.
8. Verify that the model and serial number shown on the packaging list agrees with the model and serial number on the Ts2. The model number can be found on a label affixed on the back of Ts2. Contact your TesCom distributor if the model or serial number do not match.

2.4 Rack Mounting the Ts2

The Ts2 is half of a 19-inch rack, and occupies 1.75 in (4.5 cm, 1RU) of vertical rack space. An optional mounting bracket can be provided by the local distributor.

Warning: When rack mounting the Ts2, use the original mounting screws provided with the mounting bracket so that the Ts2 case will not be damaged. Do not substitute other mounting screws.

2.5 Power and Ground Connections

2.5.1 Power

The Ts2 uses two VDC power sources, primary and backup. One or both power sources can be used. The power source can be 34 – 60 VDC. The VDC power connector uses two power feed lines, PWR A and PWR B. Ts2 comes equipped with 2 Phoenix connectors to supply PWR A and PWR B and the user needs to connect the two terminals of it to their DC +/- supplies. The Ts2 can also be powered by two VAC power sources, with 28 – 40 VAC supply.

IMPORTANT NOTE:

All operation, test and performance references and specifications that TesCom makes in its Ts2 customer documents, and on its label, and to certification authorities are based on actual measurements ONLY when operated with the power supplies that TesCom provides or offers as an optional accessory. If operated with other brands and/or different specifications of power supplies, TesCom will NOT guarantee Ts2's proper operation, functionality or its compliance with the stated standards!

2.5.2 Ground

The Ts2 ground is a 4 mm ground stud and is identified with the international ground marking as shown on  Figure 3. This ground wire should be routed to earth ground.

2.6 Input / Output Signal Connections

2.6.1 Management

Using a standard CAT5 cable, connect the cable to the port labelled MGMT of the front panel to your network. The data rate is 10/100 Base-T shielded RJ45 receptacle. The Management port supports both forms of IP address assignment, static or DHCP.

2.6.2 Console

A mini-USB connector labelled Console is available for Ts2 to have a serial connection to a PC or laptop. The user can connect to Ts2 console via terminal emulation applications on PC like Tera Term, PuTTY, minicom or Procomm to access the CLI over the serial port.

2.6.3 FREQ Out

BNC connector to port labelled FREQ Out to provide syntonized selectable frequencies output from Ts2. The FREQ Out is DC Blocked.

2.6.4 Timing outputs, 1PPS

A configurable 1PPS is provided on a BNC connector, labelled 1PPS. Connect the 1PPS signal output to a frequency counter or any other measuring device.

2.6.5 Timing inputs/outputs, ToD / 1PPS

An RJ45 port is provided, labelled ToD / 1PPS. These ports are configurable to provide input or output for ToD / 1PPS. Both, the ToD format and the 1PPS signal are configurable. Refer to [2] for details of the timing ports physical/electrical characteristics.

2.6.6 PTP Port 1 and Port 2

One shielded RJ45 copper port and one SFP port is provided in parallel for Port 1. Likewise, one shielded RJ45 copper port and one SFP port is provided in parallel for Port 2. These ports provide PTP protocol messages to the timing network. See Gateway and Boundary clock Section of this User Guide for information on how the PTP Port 1 and Port 2 perform when the Clock Type Mode is configured as Gateway or Boundary clock. Selecting the Clock Type Mode is described in **Error! Reference source not found.** Section of this User Guide.

2.7 Connecting GNSS Antenna

Connect a suitable GNSS antenna, making sure the antenna has a clear view of the sky. When the GNSS receiver has good reception, the GNSS LED will be green. Ts2 provides 5.0 VDC bias to power remote active antennas.

The GNSS antenna connector is a female SMA with external threads. Once the GNSS antenna is connected to Ts2 antenna port, the GNSS operation can be configured and monitored in the **Error! Reference source not found.** Section of this User Guide.

2.8 Applying Power

Ts2 does not have a power switch, so power should not be applied until the Ground connector is installed and connected to earth ground. To avoid accidental power up of the Ts2, please re-check and ensure all connections are made including the Ground connector, before enabling external power to Ts2.

3 Getting Started

This chapter describes on how the user can start using Ts2 system after installing Ts2 device and making the necessary connections to the various hardware interfaces.

3.1 Logging in with the console

Log into Ts2 using the mini-USB console. Default set-up is 115200 baud, 8 bits, no parity, and one stop bit. Login is admin and password are admin. Terminal emulation software like Tera Term, PuTTY, minicom and Procomm can be used for this purpose.

3.2 Set up IP address

The Management port IP address assigned to the Ts2 can be viewed using the mini-USB console.

At the factory, the Ts2 Management port IP is statically assigned to 192.168.2.100 with netmask of 255.255.255.0. This static IP address will be set after doing a restore to factory default configuration. To configure the Management port IP address for customer network:

1. Connect the Ts2 mini-USB console port to a PC and run a terminal emulator application (Tera Term, PuTTY, minicom, Procomm, etc.) to login to the Ts2. Login credentials are provided in the Ts2 Basic Commands section. Use the “network configure” command to configure the Management port IP parameters. The Network Configure Command section provides CLI command details for setting the Management port IP address, subnet mask and Gateway IP.
2. With the Management port IP address configured successfully, the IP address can be entered into a browser URL field to access the Ts2 Login page, with login credentials (admin/admin).

3.3 Remote Network Access to Ts2

Ts2 can be accessed remotely over IP network via the Management IP Interface. These are some of the methods to access Ts2 remotely:

3.3.1 HTTP/Web access

Ts2 can be accessed over the web from any standard browser (IE, Chrome, Firefox, Safari, etc.). This provides a Graphical User Interface (GUI) for the user to configure or monitor Ts2 operations.

The following web browsers / versions are supported by the Ts2 HTTP server:

- Internet Explorer / v11.0.31
- Chrome / v63.0.3239.132
- Firefox / v56.0
- Safari / v11.0.3

3.3.2 Secure Shell (SSH) access

SSH offers a secure shell for users to do remote login to Ts2 using terminal emulation software. After login, the user can use Ts2 CLI to send commands. Note that only SSH and not Telnet access is allowed for remote shell login.

3.3.3 SNMP (v2, v3)

Ts2 can be one of many managed devices on the network with an Element Management System (EMS) or Network Management System (NMS) as the centralized server. Currently, only SNMP is supported for

PTPBASE-MIB specification from Timing Over IP Connections and Transfer of Clock (TICTOC) Working Group.

3.3.4 XML API

Applications using XML interface can access Ts2 system via its XML API's. Support for this will be added in future release.

4 Command Reference

4.1 Ts2 Basic Commands

The login credentials for accessing Ts2 CLI shell is admin/admin. This is a list of the available commands related to the control and monitoring of the Ts2. The CLI commands are case insensitive.

4.1.1 Help Command

After logging in, the user can enter “help” to get a list of commands and descriptions to be displayed on the command terminal.

```
TS2> help
Commands available:
 help          Show available commands
 quit         Disconnect
 history      Show a list of previously run commands
 show alarms  Show TS2 Alarms
 show status  Show TS2 Sync Status
 clear alarms Clear TS2 Alarms
 system info  Show TS2 Version Information
 system Upgrade_Status Software Upgrade status
 system Upgrade_Start Software Upgrade start
 network configure Configure the MGMT Port
 network status MGMT Port Status
 network ping Ping Remote IP Address
 HTTPS Restore Restore factory default certificate
 date         Display/Set current date & time
 reboot      Reboot the TS2 System
 shutdown    Shutdown the TS2 System
TS2> |
```

Figure 5 Help Command

4.1.2 History Command

To view the history of previously entered commands, enter “history”.

```
TS2> history
Command history:
 0. system info
 1. help
TS2> date
UTC time: 2021-06-23 19:43:00 (+37 sec)
TS2> history
```

Figure 6 History Command

4.1.3 Quit Command

To terminate the command session and log out, enter “quit”. Note that, pressing Control-C will have the same effect as “quit” command.

4.2 Show commands

The “show” command can be used to show alarms or clock status.

4.2.1 Show Alarms Command

This command will display any active Ts2 alarms. If no alarms are present, the Alarm Name and State columns will be blank.

```
TS2> show alarms
```

| Alarm Name | Current Status | Last Failure | Failure count |
|------------------------|----------------|--------------|---------------|
| System/Internal Error* | Not Active | Not Occurred | 0 |
| GNSS Lock/Unlock | Locked | Not Occurred | 0 |
| PTP Sync Lock | Locked | Not Occurred | 0 |
| PTP Sync state | SYNCHRONIZING | Not Occurred | 0 |
| PTP Port1 Link | Down | Not Occurred | 0 |
| PTP Port2 Link | Down | Not Occurred | 0 |

*Internal hardware error

```
TS2>
```

Figure 7 Show Alarms Command

4.2.2 Show Status Command

This command shows the Managed Clock Engine’s Sync information – Ts2 Sync Status and Ts2 Sync State.

- Ts2 Sync Status can be either LOCKED or UNLOCKED.
- Ts2 Sync State can be one of the following: FREE RUNNING, SYNTONIZING, SYNCHRONIZING, or HOLDOVER.
- GNSS 1PPS Status can be either Stable or Unstable.
- GNSS ToD Status can be either Stable or Unstable.

```
TS2> show status
```

| | | |
|------------------|---|---------------|
| PTP Sync Status | : | LOCKED |
| PTP Sync State | : | SYNCHRONIZING |
| GNSS 1PPS Status | : | Stable |
| GNSS ToD Status | : | Stable |

```
TS2>
```

Figure 8 Show Status Command

4.3 Inventory commands

The Inventory commands are system-level commands.

4.3.1 System Info Command

This command displays the basic system information – Ts2 firmware version, on-board oscillator type, Managed Clock Engine Firmware version, number of PTP slaves supported and GNSS module type.

```
TS2> system info
FW Version: 2.0.0

XO: OCXO 4 hrs

Timing Engine FW Version: v2.1.2
Timing Engine FPGA Version: 2.8

PTP Slave Capacity: 32

GNSS Receiver: GPS Only

TS2> █
```

Figure 9 System Info Command

4.3.2 System Upgrade Status Command

The Ts2 System Firmware Upgrade Status will be displayed if the upgrade was initiated previously from either CLI or through Web User Interface.

```
TS2> system Upgrade_Status
FW upgrade not yet initiated

TS2> █
```

Figure 10 System Upgrade Status Command

4.3.3 System Upgrade Start Command

The Ts2 System Upgrade Start command will perform firmware upgrade when the following inputs are provided:

- File transfer protocol, 1 or 2 (for FTP or SFTP).
Note: Option 1 (FTP) has been deprecated and is not available anymore
- Hostname, as either IP address or DNS name
- File name containing the upgrade FW

```
TS2> system Upgrade_Start
Usage:
system Upgrade_Start <protocol:(1:FTP, 2:SFTP)> <hostname> <file name>

TS2>
```

Figure 11 System Upgrade Start Command

4.4 Network Commands

The Network Command operate on the Management port. The user can set up the network parameters like enable/disable DHCP, static IPv4 address, netmask, and gateway addresses and display the current setting of it. By factory default, the Management port network parameters are set statically as follows:

- DHCP: Disabled
- IP Address: 192.168.2.100

- Netmask: 255.255.255.0
- Gateway: 0.0.0.0

4.4.1 Network Configure Command

This command lets the user configure Ts2 Management port network parameters.

```
TS2> network config
Usage:
network configure dhcp
network configure ip <ip_addr> mask <netmask> gateway <gateway>
TS2>
```

Figure 12 Network Configure Command

4.4.2 Network Status Command

Get network status for the Management Port, PTP Timing Port-1, and PTP Timing Port-2.

```
TS2> network status

MGMT Port
  DHCP      : DISABLED
  IPv4 Addr : 192.168.2.100
  NetMask   : 255.255.255.0
  Gateway   : 192.168.2.1
  MAC       : fc:af:6a:04:e9:5d
  Link      : UP

PTP Timing Port-1
  IPv4 Addr : N/A
  NetMask   : N/A
  Gateway   : N/A
  IPv6 Addr : fe80:0000:0000:0000:feaf:6aff:fe02:e95d
  MAC       : fc:af:6a:02:e9:5d
  Link      : Down

PTP Timing Port-2
  IPv4 Addr : N/A
  NetMask   : N/A
  Gateway   : N/A
  IPv6 Addr : fe80:0000:0000:0000:feaf:6aff:fe01:e95d
  MAC       : fc:af:6a:01:e9:5d
  Link      : Down

TS2>
```

Figure 13 Network Status Command

4.4.3 Network Ping Command

Send a ping message to a device on the network to test reachability. The results of the ping operation are displayed as “Ping Success” or “Ping Failed”.

The ping command takes an additional parameter “mgmt” or “ptp” to specify from which port the ping request needs to go out.

```

TS2> network ping mgmt
Usage:
network ping mgmt <ip_addr>
network ping ptp <ip_addr>

TS2> network ping mgmt 192.168.2.51
Ping Failed

TS2> network ping mgmt 192.168.2.52
Ping Failed

TS2> network ping mgmt 192.168.2.5
Ping Success

TS2> network ping ptp 192.168.2.5
Ping Success

TS2>

```

Figure 14 Network Ping Command

4.5 HTTPS Restore command

This command is provided in case of user uploading an incorrect file or wrongly formatted SSL certificate (PEM format) file via Ts2 GUI. Executing this command gives the user to option to reset to factory default – removing the user uploaded SSL certificate file and restoring TesCom’s self-signed certificate. This is needed if wrong user file got uploaded and user is unable to access Ts2 from their browser.

```

TS2> HTTPS Restore
User certificate, if any, will be removed & default certificate will be restored
Do you want to continue? [Y/N] : n
Abort.

TS2> █

```

Figure 15 HTTPS Restore command

4.6 Date command

This command is provided mainly for initial customer lab bring-up or for those deployments where there is no timing reference (like GNSS) but need Ts2 to act as a Grandmaster to propagate time and synchronization over PTP to slave units. This command enables the user to set the date and time (ToD) on Ts2 manually. The user can enter the wall-clock time for the present date and time with this command with the “set” option. The date command without any parameters will display the current ToD.

```

TS2> date set 2021-06-23-19-51-30
UTC time: 2021-06-23 19:51:30 (+37 sec)

TS2> date
UTC time: 2021-06-23 19:51:42 (+37 sec)

TS2> date set
Usage:
date
date set yyyy-mm-dd-hh-mm-ss (UTC)

TS2> date set 2021-06-23-19-51-30
UTC time: 2021-06-23 19:51:30 (+37 sec)

```

NOTE: If there is a proper timing reference available (like GNSS time or a remote PTP master), then the time set by this command will be overwritten by the actual ToD received from the timing reference. This command is not needed for normal operation with a good timing reference.

4.7 Reboot command

The Reboot command is to provide for user initiated manual reboot of Ts2 system. Note that a firmware upgrade will automatically initiate reboot of the system.

5 Troubleshooting and Safety Considerations

This section provides some Ts2 Troubleshooting and Safety Considerations. References are provided on how to get technical or sales assistance and how to obtain manual updates.

5.1 Troubleshooting

This section provides some Ts2 Troubleshooting practices and the indicators for when a problem may be present in the Ts2 operation. Some of the indicators of Ts2 problems are Front Panel LED states, Interface and PTP Webpage statuses and the **Error! Reference source not found.** Webpage.

| Symptom | Probable Cause | Recommended Action |
|------------------|---|--|
| Power LED is Red | User Interface and Control Plane Processor has not completed its boot up process. | Wait for a few seconds for it to turn orange and then finally green when all of software has been brought up. It takes approximately 4 minutes for the LED to turn green when system is ready for operation. |
| | Power supply does not meet Ts2 requirements. | Verify that the voltage from the Ts2 power source meets the specifications of the Power Section. |
| | Ts2 Alarm condition is affecting power. | Check the Error! Reference source not found. Webpage for information about any Ts2 alarms that might affect power. |

| Symptom | Probable Cause | Recommended Action |
|-----------------|--|--|
| GNSS LED is Off | Ts2 has not completed its boot up process. | Wait approximately 4 minutes for software to complete booting. |
| | MCE running in PTP Only mode. | None. The LED is off when MCE is in PTP Only mode. |

| Symptom | Probable Cause | Recommended Action |
|-----------------|--|--|
| GNSS LED is Red | 1 PPS Input Error on Front Panel RJ45 port | Verify that the input RJ45 connector is securely inserted in the port. Verify that the 1 PPS source is outputting a 1 PPS signal. |
| | ToD Input Error on Front Panel RJ45 port | Verify that the input RJ45 connector is securely inserted in |

| | | |
|--|--|--|
| | | the port. Verify that the ToD source is outputting a ToD signal. |
| | GNSS input signal from Antenna and cable is missing or weak. | Verify that the GNSS Antenna coax is securely plugged into the SMA port. Verify that the GNSS Antenna signal is present. |
| | Ts2 Alarm condition is affecting 1 PPS or ToD Input. | Check the Error! Reference source not found. Webpage for information about any Ts2 alarms that might affect 1 PPS or ToD Input. |

| Symptom | Probable Cause | Recommended Action |
|------------------------|--|---|
| Sync Status LED is Off | MCE Processor has not completed its boot up process. | Wait approximately 4 minutes for the MCE processor to complete booting. |

| Symptom | Probable Cause | Recommended Action |
|------------------------|--|---|
| Sync Status LED is Red | MCE is operating in GNSS Only mode and is not receiving the GNSS inputs. | Verify that the GNSS LED is Green. |
| | MCE is operating in PTP Only mode and is not receiving PTP Grand Master timing messages. | Verify that the PTP Port 1 or Port 2 is connected to a PTP Grand Master time source through the RJ45 or SFP connectors. Verify that the PTP Grand Master is providing PTP Timing messages. |
| | MCE is operating in GNSS Primary / PTP Secondary mode, or in PTP Primary / GNSS Secondary mode and is not receiving timing signals from either source. | Verify that the GNSS LED is Green. Verify that the PTP Port 1 or Port 2 is connected to a PTP Grand Master time source through the RJ45 or SFP connectors. Verify that the PTP Grand Master is providing PTP Timing messages. |

| | | |
|--|---|---|
| | The user has selected external 1PPS / ToD inputs but has not connected the input sources. | On the Ts2 Front Panel, connect the 1PPS / ToD RJ45 input source. On the Error! Reference source not found. web page, Enable 1PPS In and ToD In. |
| | Ts2 Alarm condition is affecting inputs from the GNSS or the PTP Grand Master. | Check the Error! Reference source not found. Webpage for information about any Ts2 alarms that might affect timing input signals. |

| Symptom | Probable Cause | Recommended Action |
|--------------------------|---|--|
| Sync Status LED is Amber | MCE is operating in GNSS Only mode and is not synchronized to the GNSS input. | Verify that the GNSS LED is Green. |
| | MCE is operating in PTP Only mode and is not synchronized to the PTP Grand Master. | Verify that the PTP Port 1 or Port 2 is connected to a PTP Grand Master time source through the RJ45 or SFP connectors. Verify that the PTP Grand Master is providing PTP Timing messages |
| | MCE synchronization loop control system has not converged to the input timing source. | Wait 2 to 15 minutes for the MCE to converge and synchronize to the input timing source. |
| | Ts2 Alarm condition is affecting MCE synchronization. | Check the Error! Reference source not found. Webpage for information about any Ts2 alarms that might affect MCE synchronization. |

| Symptom | Probable Cause | Recommended Action |
|---|---|---|
| Home Webpage – GNSS 1 PPS Status Unstable/Unavailable | GNSS input signal from Antenna and cable is missing or weak. | Verify that the GNSS Antenna coax is securely plugged into the SMA port. Verify that the GNSS Antenna signal is present. |
| | GNSS Antenna / cable configuration does not meet requirements of the Antenna input Section. | Verify that the GNSS Antenna / cable meets requirements of the Antenna input Section. |

| | | |
|--|--|--|
| | Ts2 Alarm condition is affecting inputs from the GNSS. | Check the Error! Reference source not found. Webpage for information about any Ts2 alarms that might affect GNSS input signals. |
|--|--|--|

| Symptom | Probable Cause | Recommended Action |
|---|---|---|
| Home Webpage – GNSS ToD Status Unstable/Unavailable | GNSS input signal from Antenna and cable is missing or weak. | Wait approximately 2 minutes for the MCE processor to complete booting. |
| | GNSS Antenna / cable configuration does not meet requirements of the Antenna input Section. | Verify that the GNSS Antenna / cable meets requirements of the Antenna input Section. |
| | The user has selected external 1PPS / ToD inputs but has not connected the input sources. | On the Ts2 Front Panel, connect the 1PPS / ToD RJ45 input source. On the Error! Reference source not found. web page, Enable 1PPS In and ToD In. |
| | Ts2 Alarm condition is affecting inputs from the GNSS. | Check the Error! Reference source not found. Webpage for information about any Ts2 alarms that might affect GNSS input signals. |

| Symptom | Probable Cause | Recommended Action |
|---|--|---|
| Interface :: PTP Timing Ports Webpage – Link State not up | PTP Timing Port 1 or Port 2 IP address configuration is incorrect. | Verify that IP configuration for Port 1 and Port 2 is correct on the Error! Reference source not found. Webpage. Verify that the network routers/switches/hubs between the Ts2 Port 1 and Port 2 and the timing network are properly connected. |
| | Port 1 and Port 2 are in the same network / subnet as the MGMT port. | Make sure that the IP addresses of Port 1, Port 2 and MGMT port are on different networks/subnets. |
| | Ts2 Alarm condition is affecting Timing Ports Link State. | Check the Error! Reference source not found. Webpage for information about any Ts2 |

| | | |
|--|--|---|
| | | alarms that might affect Timing Ports Link State. |
|--|--|---|

| Symptom | Probable Cause | Recommended Action |
|--|--|---|
| Interface::MGMT Port Webpage – Link State not up | MGMT Port IP address configuration is incorrect. | Verify that IP configuration for MGMT Port is correct on the Error! Reference source not found. Webpage. Verify that the network routers/switches/hubs between the Ts2 MGMT Port and the management network are properly connected. |
| | MGMT Port is on the same network / subnet as the timing ports. | Make sure that the IP address of the MGMT port and the addresses of Port 1 and Port 2 are on different networks/subnets. |
| | Ts2 Alarm condition is affecting MGMT Port Link State. | Check the Error! Reference source not found. Webpage for information about any Ts2 alarms that might affect MGMT Port Link State. |

5.2 Safety Considerations

The following safety consideration should be used when handling and installing the Ts2.

- When installing or working on the Ts2 equipment, ESD wrist straps should be worn.
- Use the specified power supply and ground for the Ts2 equipment as stated in the Power and Ground Connections section.
- Refer to the Applying Power section when applying power to the Ts2 equipment.
- When rack mounting the Ts2 equipment, use the original mounting screws provided with the mounting bracket so that the Ts2 case will not be damaged. Do not substitute other mounting screws.
- Only authorized personnel should open the Ts2 equipment enclosure. Unauthorized access to the Ts2 equipment could result in equipment damage and voiding the Ts2 warranty.
- Use caution when installing the GNSS antenna near, under, or around high voltage lines. The GNSS antenna should be equipped with proper external lightning protection/grounding to avoid equipment damage should the antenna receive a lightning strike.
- If the Ts2 is rack mounted, 1RU above the Ts2 enclosure must be left unoccupied for heat dissipation.

6 Managed Clock Engine Overview

6.1 Ts2 Engine Modes

The Ts2 Managed Clock Engine can operate in four different modes. The operational mode defines the functionality supported by the engine, Ts2 clock behavior and its properties in different operating conditions. The operational mode is specified upon startup and can only be changed by restarting the engine on the **Error! Reference source not found.**

- PTP Only
- GNSS Only
- GNSS Primary, PTP Secondary
- PTP Primary, GNSS Secondary.

In addition to these four modes, a Slave Only mode is supported. The clock can be switched to the Slave Only mode and back at any time and from any of above operational modes. The Slave Only mode is selected on the **Error! Reference source not found.** Webpage.

6.1.1 PTP Only mode

This is an ordinary PTP master-slave mode. The GNSS interface is disabled. In this mode, the clock normally acts as a PTP slave, but may also become a PTP master if no better clock exists on the network based on the Best Master Clock Algorithm (BMCA).

The clock class is initialized to value of DEFAULT (248).

6.1.2 GNSS Only mode

In this mode, the clock is a GNSS-clock and the GNSS is the only source of synchronization. The clock can never become a slave to another clock regardless of its clock class.

In this mode, the clock class is automatically controlled by the engine. The clock is initialized with class of DEFAULT (248), and when it locks to a stable GNSS signal it raises the class to PRC_SYNC (6) or APP_SYNC (13). If only the 1PPS-input signal is available, then the class APP_SYNC (13) is selected. If the ToD-input signal is available as well, then the timescale is automatically switched to PTP and the clock class is PRC_SYNC (6).

Later, if the GNSS-signal is lost, the clock switches to the holdover mode and lowers its class to PRC_HOLDOVER (7) or APP_HOLDOVER (14). If after the holdover period, the GNSS-signal is still not available the clock downgrades its class PRC_DEGRADATION_A (52) or APP_DEGRADATION_A (58) and stays as the PTP master in the free running mode. If a better clock exists on the network based on BMCA, the clock will switch to the PTP passive state.

6.1.3 GNSS Primary, PTP Secondary mode

This mode is almost the same as Mode 1, but after the holdover interval the clock degrades its class to PRC_DEGRADATION_B (187) or APP_DEGRADATION_B (193), so clock can potentially become a PTP slave if a better clock appears on the network.

This mode means that the Ts2 clock has the GNSS-signal as its primary source of synchronization and the PTP as a backup source, i.e. when no GNSS-signal present.

6.1.4 PTP Primary, GNSS Secondary Mode

This mode is designed for unstable GNSS-reception environments, where the node having a better signal reception becomes a PTP master and all others become PTP slaves, even if they have their own GNSS-signal.

The clock is initialized with class DEFAULT (248) and the class is not changed by the engine while operating. Instead after detecting the stable GNSS-signal the engine increases the priority2 member of the Default Dataset (lowers its value) by some small margin, which might depend on the reception quality. That clock which has a higher priority2 (better GNSS signal reception) becomes the PTP master on the network and all others synchronize with it.

6.2 GNSS Interface

The Ts2 supports GNSS L1 input signals from a GNSS antenna. Signal frequency is 1575.42 MHz for GPS; 1561.098 MHz for Beidou; and 1602.0 MHz for Glonass. The status and configuration of GNSS interface can be accessed via the **Error! Reference source not found.** Webpage.

6.3 Ts2 Clock Sync States

Ts2 clock at any instance of time can be in one of four following sync states:

- FREE RUNNING
- SYNTONIZING
- SYNCHRONIZING
- HOLDOVER
- UNKNOWN/ERROR

6.3.1 FREE RUNNING State

The Ts2 clock comes into this state upon initialization. The Ts2 clock time is not set, the clock class is DEFAULT (248), clock accuracy is UNKNOWN (0xFE).

The timescale is PTP, the UTC offset is initially set to 37 secs, leap flags are FALSE. In Free Running state, the clock frequency comes from the on-board oscillator.

6.3.2 SYNTONIZING State

This state is only possible when the 1PPS-input signal from the GNSS interface is available, but not the ToD-input signal and the clock become a PTP master.

When the Ts2 engine is running in GNSS Only mode or PTP Only mode, the clock class is automatically changed to either PRC_SYNC (6) or APP_SYNC (13) and the clock accuracy is set to WITHIN_100_NS. In GNSS Primary, PTP Secondary mode, the clock class remains unchanged.

Note that the frequency can be traced, but not the time in this state. Once the ToD-input signal becomes available the clock switches to SYNCHRONIZING state.

6.3.3 SYNCHRONIZING State

The Ts2 clock enters this state when it starts to synchronize its time and frequency with either a PTP or GNSS source. If the synchronization source is the GNSS, then both time and frequency are present and traceable. The timescale is changed to PTP, the clock class is changed to PRC_SYNC (6) and the clock accuracy is set to WITHIN_100_NS.

If the ToD-input signal becomes unavailable, while the 1PPS-input is still present, the Ts2 clock switches to SYNTONIZED state.

If the synchronization source is a PTP master, then the clock quality remains unchanged. The timescale is set according to what is distributed by the PTP master. If the timescale distributed is PTP then the UTC offset (if valid) and leap flags are also set to master's values and the time source is set to PTP.

6.3.4 HOLDOVER State

The Ts2 clock enters this state when the synchronization source is lost. If the clock was synchronized with PTP master its clock class remains unchanged. Otherwise the clock class is modified according to the engine's operational mode and the clock accuracy is changed based on the time spent in the holdover state.

There is a static parameter which defines the clock stability. Currently it is fixed to 1 ns/s for a temperature-stable environment. During the holdover state an estimated error value is calculated and the clock accuracy is set according to that value.

The maximum time the clock stays in holdover state is defined by a holdover interval. By default, this value is set to 1000 seconds which gives about 1 microsecond error at the end of holdover interval. After holdover interval expires, the clock switches to the FREE RUNNING state, and its accuracy is reset to UNKNOWN (0xFE).

6.3.5 UNKNOWN/ERROR State

The Ts2 clock has entered a failed or error condition and the sync state is unknown.

6.4 Unicast Operations

By default, unicast operations are disabled and the Ts2 port operates in multicast mode. After unicast is enabled no multicast communications are possible.

The PTP port can be switched to unicast operations and back at any time using the **Error! Reference source not found.** and **Error! Reference source not found.** Sections of this User Guide.

6.4.1 Unicast Master

A Ts2 port in unicast master state can support:

- Slave nodes which dynamically request unicast message transmission services from the master using the unicast negotiation mechanism.
- Slave nodes which do not support the unicast negotiation and simply rely on the reception of unicast messages from the master.

To accept unicast negotiation requests from slave nodes the master needs to be configured as follows:

- Unicast negotiation must be enabled.
- Slave acceptance filter must be populated. Note that in the current design, the slave acceptance filter is not user configurable and it is set to accept all slaves.

To provide message transmission services to slave nodes which do not support the unicast negotiation the master needs to be manually configured with the list of static slave nodes.

6.4.2 Enabling Master Unicast Negotiation

The unicast negotiation state is controlled by the **Error! Reference source not found.** Section of this User Guide.

When unicast negotiation is enabled the master accepts unicast transmission requests from negotiation-capable nodes. If a node is allowed by the acceptance filter and if enough resources are available the master grants message transmission services to that node.

If unicast negotiation is disabled no new requests are accepted, but all existing grants remain serviced until they are either expired or cancelled.

6.4.3 Maintaining Master's Slave Acceptance Filter

Note: In the current implementation, the slave acceptance filter is not user configurable and it is set to accept all slaves. In that respect, the following documentation on slave acceptance filter is only for academic purpose.

The slave acceptance filter is a mechanism to control which slave nodes may obtain unicast services from the master. If the filter table is empty no services will be granted to any node. The **Error! Reference source not found.** Section of this User Guide is used to manipulate the slave acceptance filter.

As the result of the filter table modification, if a node becomes unacceptable or message rates of any active grants becomes beyond the newly configured limits, all affected grants will be cancelled.

6.4.4 Maintaining Master's List Of Static Slaves

Note: In the current implementation, this is not supported. To provide unicast services to slaves which do not support the unicast negotiation the master maintains a list of static slave nodes.

When a node is in this list the master can send Announce and Sync messages to that node and can reply to Delay Request messages received from that node.

Error! Reference source not found. Section of this User Guide is used to monitor and manipulate the static slave node list.

6.4.5 Monitoring Unicast Operations

Monitoring the status of master unicast operations can be done on the **Error! Reference source not found.** and **Error! Reference source not found.** Sections of this User Guide.

6.5 Gateway and Boundary clock

The Ts2 Multi-Sync Gateway has the capability of using both of its Ethernet ports (Port 1 and Port 2) as PTP ports. This opens the possibility of using the Ts2 as a two-port gateway or boundary clock. For more information about Gateway and Boundary Clocks, see [1].

6.5.1 The Gateway Clock

The Gateway Clock (GC) can be considered as an Ordinary Clock (OC) with two ports, with one port configured as a master and the other port configured as a slave.

Another capability of the Ts2 is for both ports to be configured as master ports. In that configuration, each port would have its own IP address and be associated with different subnets. However, both ports would have the same PTP Clock Identity. With each port connected to different subnets, the ports can serve as GM for the slaves on the two different subnets. The slaves on the two separate subnets would then use the BMCA to select the best GM from which to recover the PTP time messages.

6.5.2 The Boundary Clock

The Boundary Clock (BC) has one port defined as a master port and the second port as a slave port receiving PTP messages from an external Grand Master (GM) Clock. The PTP Clock Webpage is used to set the Ts2 clock as a boundary clock, described in **Error! Reference source not found.** Section of this User Guide.

The following figure illustrates the difference between a Gateway Clock and a Boundary Clock. The slaves connected to a Gateway Clock will only recognize the Gateway Clock as a Grand Master and not any other upstream masters. In the following figure, the slaves connected to the Gateway Clock will not recognize the Clock 1(GM). The slaves that are connected to the Boundary Clock will recognize Clock 1(GM) as the Grand Master.

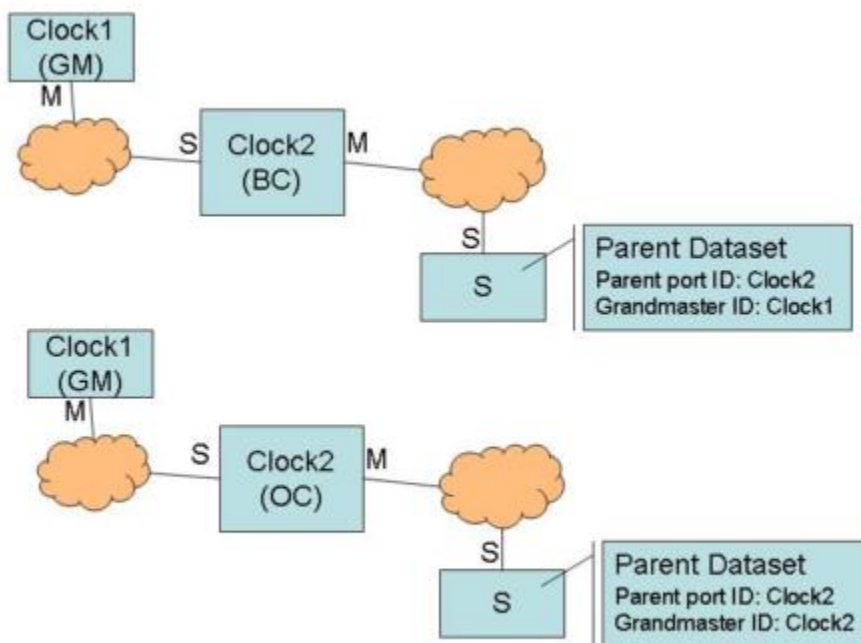

Figure 16 Gateway Clock (GC) vs. Boundary Clock (BC)

6.6 PTP Servo Configuration Parameters

6.6.1 Main Time Constant

The main time constant used by the PTP Servo algorithm, in seconds. A longer time constant makes the oscillator frequency change more slowly and less responsive to changes in a network environment, such as the temperature or the network delays. For networks with low packet delay variation a short time

constant (e.g. 30 sec) can be used. For networks with unknown or high traffic load, a longer time constant (e.g. 300 sec) would be a better setting. A longer time constant requires a more stable oscillator to be effective. For example, a time constant above 500 sec requires the Ts2 super OCXO. The default value is 100 sec.

6.6.2 Startup Time Constant

The time constant used during the period of obtaining a preliminary synchronization (startup phase), in seconds. If this field is set to 0 the main time constant will be used. This parameter can help to shorten the synchronization time when a long main time constant is required. But values that are too short may lead to unwanted oscillations which increase the total time required to synchronize and eliminate any positive effects of shorter startup time constant. The default value is 0.

6.6.3 Quality Threshold

Defines the maximum allowed time variation in nanoseconds before the slave goes into holdover. The time variation is based on a statistical measurement of time error between the source input time and the slave's formulated time, where the source input time is the GNSS or ToD + 1PPS input. The default value is 1500 nsec.

6.6.4 Network Type

The Network Type selection is used to adjust the loop control algorithm behavior according to the underlying network characteristics. There are two types of networks currently supported: Unmanaged and Managed.

“Unmanaged” selection is used for a network with unknown or unspecified packet delay and delay variation or with packet delay distribution that may dramatically change its characteristics over time.

“Managed” selection is used for a network where the packet delay and delay variation distribution are specified and that always has a distinct “floor”. That “floor” may vary over the time, but the distribution limitations provided by the “floor” should still be present.

6.6.5 Frequency Out

The syntonized frequency that will be output on the FREQ Out port on the Ts2 Front Panel.

6.7 Synchronous Ethernet (SyncE)

6.7.1 What is Synchronous Ethernet?

Synchronous Ethernet feature is to help in providing frequency syntonization over packet based networks using Ethernet. It provides a mechanism to distribute frequency from Ethernet packet network to Time Division Multiplexed (TDM) circuits and nodes. For this, the (natively asynchronous) Ethernet physical layer is utilized in a fashion similar to (natively synchronous) SONET/SDH networks, with clock recovery and the assist of a new IEEE 802.3 slow-protocol packet called Ethernet Synchronization Channel Message (ESMC). This ESMC message is to convey the reference clock quality and traceability information in the form of Quality Level (QL). The SyncE feature is considered a physical layer characteristic unlike PTP which is in higher-layer software.

In today's and next generation networks, there is need for time and not just frequency synchronization. That is, a combination of frequency, phase and time-of-day synchronization is required and expected to

be delivered in a reliable and resilient fashion. Synchronous Ethernet can provide a stable frequency and can also be used as a local short-term holdover clock for maintaining time.

6.7.2 SyncE feature in Ts2

Synchronous Ethernet feature is a configurable option on Ts2 that can be enabled or disabled from the Home webpage, depending on the customer use-case and deployment. There are 4 main modes of operation in which SyncE feature can be deployed as described below. The PHY's used in Ts2 support SyncE in terms of supporting clock recovery on Ethernet Rx and being able to provide 125MHz clock externally for Ethernet Tx. This is supported with native RJ45 (1000BASE-T) PTP port interfaces and with optical 1GE SFP modules. SyncE is currently not supported on Copper SFPs.

6.7.3 SyncE in OFF mode

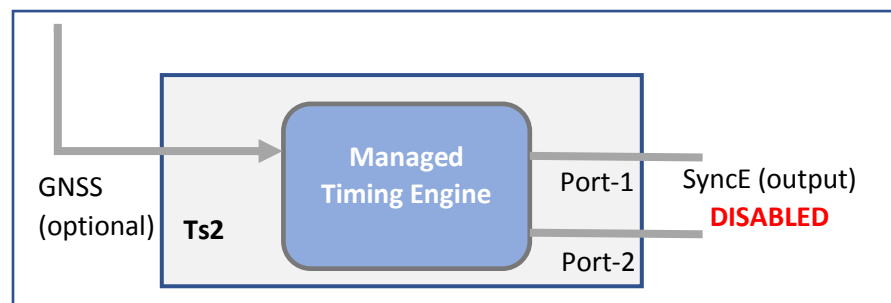

Figure 17 SyncE OFF

In this mode of operation, Synchronous Ethernet feature is turned off completely. Any incoming ESMC packets will be ignored and not processed, and no generation of outgoing ESMC packets. No clock recovery is done on Ethernet Rx. Frequency, along with phase and time are extracted from GNSS or PTP. This applies to both PTP ports.

6.7.4 SyncE in Master mode

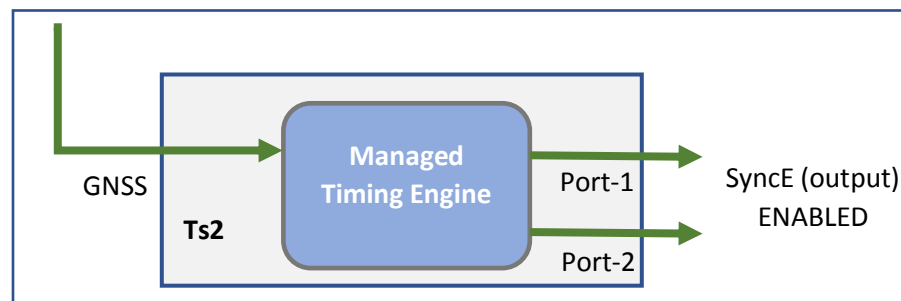

Figure 18 SyncE in Master Mode

In this mode of operation, Ts2 is in GNSS-only operating mode where it gets 1pps and ToD signals from a GNSS receiver (internal or external to Ts2), which was originally extracted from GNSS L1 signal. In this mode, the frequency, phase and time references are extracted from GNSS signal, and SyncE is output on

both ports for frequency with ESMC/QL message distribution to next downstream L2 network node. The outgoing QL enumeration is PRC (for EEC Option-1) or PRS (for EEC Option-2) when locked to GNSS.

6.7.5 SyncE in Boundary Clock Mode

In Boundary Clock mode, SyncE feature can be enabled when engine is operating in PTP-only mode. In this mode, one of the PTP ports operates as a PTP-slave synchronizing to a PTP master upstream, while the other PTP port operates as a PTP-master distributing time and sync downstream to other PTP slaves.

There are some differences that should be noted when using L2 (Ethernet multicast) based PTP profile like G8275.1 and L3 based PTP profile like G8275.2. More details to follow in the sections below.

6.7.5.1 SyncE in Boundary Clock Mode for G8275.1 Telecom Profile

G8275.1 profile is specified for PTP clock distribution in a Layer-2 Ethernet multicast network. This network is expected to have full on-path support, ie. every node is PTP-aware and participates in the PTP protocol. When Ts2 is put in Boundary Clock mode in this network, the input SyncE from upstream is used as frequency reference and used directly for SyncE distribution on downstream port.

On Ts2 Home webpage, the SyncE selection provides the flexibility of specifying upstream port (PTP slave + SyncE reference input) and downstream port (PTP slave + SyncE output) and as shown in the figures below.

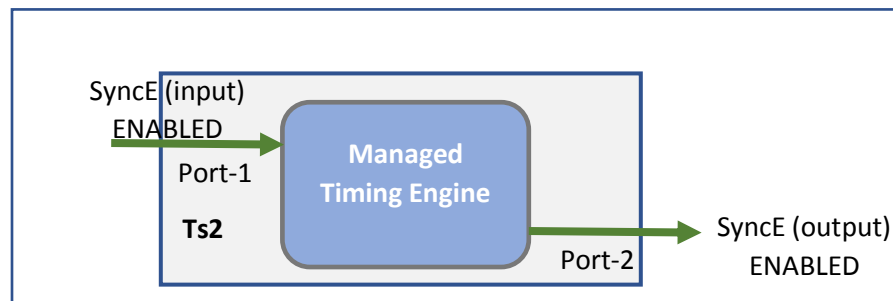

Figure 19 SyncE in BC mode for G8275.1, ref input on Port-1

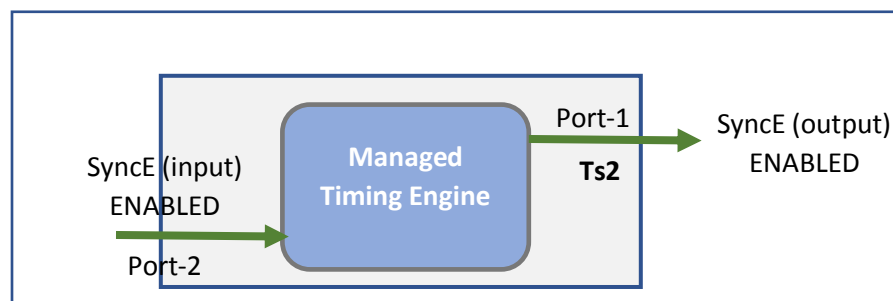

Figure 20 SyncE in BC mode for G8275.1, ref input on Port-2

6.7.5.2 SyncE in Boundary Clock Mode for G8275.2 Telecom Profile

G8275.2 profile is specified for L3 unicast network and is based on partial timing support from the network. This means that not all network nodes may participate in PTP protocol. In this mode, SyncE input frequency reference can be used as a frequency-assist for PTP. The physical layer (ie. frequency) output is controlled by both, the input (from SyncE) and PTP engine. Unlike in G8275.1, here the physical layer output is NOT directly from input reference and hence not traceable and cannot be used for SyncE output distribution. SyncE output is disabled in this case.

The figures below show the flexibility of specifying the ports for operation in this mode.

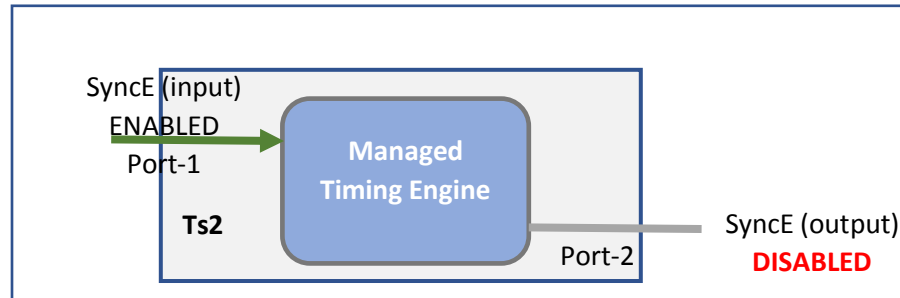

Figure 21 SyncE in BC mode for G8275.2, ref input on Port-1

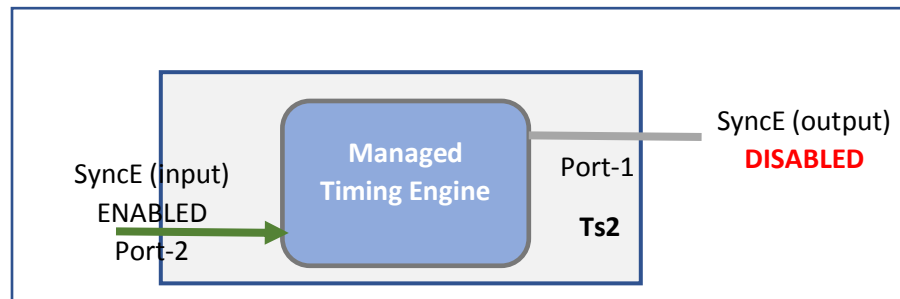

Figure 22 SyncE in BC mode for G8275.2, ref input on Port-2

6.7.6 SyncE – additional notes

Some additional notes regarding SyncE feature in Ts2:

1. Synchronous Ethernet is supported only for 1GE interface speed. If user had configured previously on Interfaces::PTP webpage for a different Auto-Negotiation and speed parameters, they will be reset to 1000Mbps Full-duplex.
2. Support for enhanced EEC (eEEC) bandwidth options will be supported in future release
3. For other profiles besides G8275.1 and G8275.2, the SyncE operation will depend on whether the profile is specified for L2-multicast or L3-unicast. If L2-multicast, then it will follow G8275.1 operation, and if L3-multicast, it will follow G8275.2 operation.
4. SyncE operation is valid only in association with Operating Modes, GNSS-only and PTP-only. Synchronous Ethernet field should be set to off for other operating modes.

7 Physical Interfaces

7.1 Antenna input

SMA 50 ohm. Protected for shorted antenna. The Ts2 provides 5.0 VDC bias to power remote active antennas that provide 40 dB gain. The antenna system supports cable length up to 50 meters with RG59/RG58 and 50 to 100 meters with LMR500/LMR600.

7.2 Console

The console port uses mini-USB serial terminal protocol. The connector is on the front panel and the default settings are as follows:

- Baud = 115.2K
- Data Bits = 8 bits
- Parity = None
- Stop Bits = 1
- Flow Control = None

7.3 Hard Reset Button

The Hard Reset Button provides 2 different functionalities depending on how it is used or pushed. These are described below.

Note: It should be noted that using the Hard Reset Button should be a last resort consideration as it is abrupt and not a graceful way.

7.3.1 Hard Reset Button – Quick Push for Reboot

When Hard Reset Button is pushed and held for a short duration (approx. 1 or 2 seconds), it will reboot the unit. The current configuration of Ts2 is preserved.

7.3.2 Hard Reset Button – Long Push for Factory Reset

When Hard Reset Button is pushed and held for a longer duration (approx. 10 seconds), it will do a factory reset of the unit followed by a reboot. The current configuration of Ts2 will NOT be preserved and the user should save and restore their configuration as needed.

7.4 Management interface

Management port is 10/100BaseT RJ45. The Management port supports DHCP, HTTP Webpages, XML, SNMP (v2,v3), and SSH remote login.

7.5 Frequency Out port

BNC 50 ohm. 3.3V TTL DC blocked. Frequency Out selectable on the **Error! Reference source not found.** Webpage.

7.6 1PPS timing output

BNC 50 ohm. 3.3V TTL output.

7.7 Time-of-Day / 1PPS input/output

ToD / 1PPS port is RJ45, input/output. The pin-outs for this RJ45 connector are defined in ITU-T G.703 Transmission Systems and Media, Digital Systems and Networks, Section 19. For more information about ITU-T G.703, see [6].

The Time-of-Day Input format is selectable on the **Error! Reference source not found.** Webpage and the Time-of-Day Output format is selectable on the **Error! Reference source not found.** Webpage. The selections for both input and output are NMEA, ASCII text and China Mobile.

7.8 PTP interface, Port 1 and Port 2

Two Electrical RJ45 ports and two SFP ports. Each RJ45 port can support triple-speed (10/100/1000 Mbps) and each SFP port can support 1GE.

For Port 1, the same PTP messages/packets will be present in both the RJ45 and SFP connections, but the data rates may be different depending on the speed of the network to which they are connected.

For Port 2, the same PTP messages/packets will be present in both the RJ45 and SFP connections, but the data rates may be different depending on the speed of the network to which they are connected.

7.8.1 SFP (and SFP+) optical modules for PTP Port 1 and 2

SFP optical modules can be plugged into the PTP ports for Ethernet connectivity instead of the electrical RJ45 ports. These ports have been designed for standard SFP 1GE modules and dual-rate SFP+ modules operating at 1GE speed.

TesCom has verified the operation with modules from leading vendors as shown below:

Finisar: FTRJ8519P1BNL, FCLF-8521-3

Intel: AFBR709DMZ-IN3

Avago: AFBR-709SMZ

Ubiquity: UF-MM-1G

FiberStore (FS): H3C SFP-10GSR-85 (SFP+ dual-rate configured for 1GE)

NOTE: SFP Copper modules are also available and will work with Ts2. The user should be aware that in that case, the PHY is inside the SFP Copper and in most cases will not fully support Synchronous Ethernet feature. In that case, we recommend to use the native electrical RJ45 ports on Ts2.

7.9 LED Description

The Ts2 has 3 LED's on the front panel which communicates the status of the Power, GNSS Signal and Sync Status.

7.9.1 Power

| Power LED state | Description |
|------------------|--|
| Red | Any of the internal voltages are in alarm state |
| Amber/Orange | Initial boot and OS load completed successfully. Loading Applications. |
| Green | HW and SW Applications loaded and ready for normal operation |
| Green - blinking | Ts2 software upgrade in progress – do NOT reboot or turn power off! |
| Red - blinking | Previous attempt to upgrade software on Ts2 failed |

7.9.2 GNSS

| GNSS LED state | Description |
|----------------|---|
| Off | MCE not running or MCE running in PTP only mode or software upgrade in progress |
| Red | 1PPS Input Error or ToD Input Error |
| Green | Signal acquired, 1PPS Input or ToD Input Available |

7.9.3 Sync Status

| Sync Status LED state | Description |
|-----------------------|--|
| Off | MCE not running or software upgrade in progress |
| Red | MCE running, Not Synchronized and engine state is FREE RUNNING |
| Amber | MCE running, Not Synchronized and engine state is SYNCHRONIZING, SYNTONIZING or HOLDOVER |
| Green | MCE running, Locked / Synchronized |

7.10 Power

The options are -48 VDC, (-34 to -60 VDC supply) or 28 – 40 VAC. 17-25W power consumption, depending on oscillator option.

| Estimated Power Consumption based on Oscillator Option | |
|--|-------------------|
| Oscillator Option | Power Consumption |
| OCXO | 17 watts |
| Super OCXO | 25 watts |

7.11 Physical dimensions

Size: 218 (W) x 160 (D) x 43 (H) mm excluding connectors

Weight: 1.01 kg

8 End User License Agreement (2020 - 2021)

IMPORTANT, PLEASE READ CAREFULLY. THIS IS A LICENSE AGREEMENT

This SOFTWARE PRODUCT is protected by copyright laws and international copyright treaties, as well as other intellectual property laws and treaties. This SOFTWARE PRODUCT is licensed, not sold. End User License Agreement This End User License Agreement ("EULA") is a legal agreement between you (either an individual or a single entity) and TesCom with regard to the copyrighted Software (herein referred to as "SOFTWARE PRODUCT" or "SOFTWARE") provided with this EULA. The SOFTWARE PRODUCT includes computer software, the associated media, any printed materials, and any "online" or electronic documentation. Use of any software and related documentation ("Software") provided to you by TesCom in whatever form or media, will constitute your acceptance of these terms, unless separate terms are provided by the software supplier, in which case certain additional or different terms may apply. If you do not agree with the terms of this EULA, do not download, install, copy or use the Software. By installing, copying or otherwise using the SOFTWARE PRODUCT, you agree to be bound by the terms of this EULA. If you do not agree to the terms of this EULA, TesCom is unwilling to license the SOFTWARE PRODUCT to you.

1. Eligible Licensees. This Software is available for license solely to SOFTWARE owners, with no right of duplication or further distribution, licensing, or sub-licensing. IF YOU DO NOT OWN THE SOFTWARE, THEN DO NOT DOWNLOAD, INSTALL, COPY OR USE THE SOFTWARE.
2. License Grant. TesCom grants to you a personal, non-transferable and non-exclusive right to use the copy of the Software provided with this EULA. You agree you will not copy the Software except as necessary to use it on a single computer. You agree that you may not copy the written materials accompanying the Software. Modifying, translating, renting, copying, transferring or assigning all or part of the Software, or any rights granted hereunder, to any other persons and removing any proprietary notices, labels or marks from the Software is strictly prohibited. Furthermore, you hereby agree not to create derivative works based on the Software. You may not transfer this Software.
3. Copyright. The Software is licensed, not sold. You acknowledge that no title to the intellectual property in the Software is transferred to you. You further acknowledge that title and full ownership rights to the Software will remain the exclusive property of TesCom and/or its suppliers, and you will not acquire any rights to the Software, except as expressly set forth above. All copies of the Software will contain the same proprietary notices as contained in or on the Software. All title and copyrights in and to the SOFTWARE PRODUCT (including but not limited to any images, photographs, animations, video, audio, music, text and "applets," incorporated into the SOFTWARE PRODUCT), the accompanying printed materials, and any copies of the SOFTWARE PRODUCT, are owned by TesCom or its suppliers. The SOFTWARE PRODUCT is protected by copyright laws and international treaty provisions. You may not copy the printed materials accompanying the SOFTWARE PRODUCT.
4. Reverse Engineering. You agree that you will not attempt, and if you are a corporation, you will use your best efforts to prevent your employees and contractors from attempting to reverse compile, modify, translate or disassemble the Software in whole or in part. Any failure to comply with the above

or any other terms and conditions contained herein will result in the automatic termination of this license and the reversion of the rights granted hereunder to TesCom.

5. Disclaimer of Warranty. The Software is provided "AS IS" without warranty of any kind. TesCom and its suppliers disclaim and make no express or implied warranties and specifically disclaim the warranties of merchantability, fitness for a particular purpose and non-infringement of third-party rights. The entire risk as to the quality and performance of the Software is with you. Neither TesCom nor its suppliers warrant that the functions contained in the Software will meet your requirements or that the operation of the Software will be uninterrupted or error-free. TesCom IS NOT OBLIGATED TO PROVIDE ANY UPDATES TO THE SOFTWARE.

6. Limitation of Liability. TesCom's entire liability and your exclusive remedy under this EULA shall not exceed the price paid for the Software, if any. In no event shall TesCom or its suppliers be liable to you for any consequential, special, incidental or indirect damages of any kind arising out of the use or inability to use the software, even if TesCom or its supplier has been advised of the possibility of such damages, or any claim by a third party.

7. Rental. You may not loan, rent, or lease the SOFTWARE.

8. Upgrades. If the SOFTWARE is an upgrade from an earlier release or previously released version, you now may use that upgraded product only in accordance with this EULA. If the SOFTWARE PRODUCT is an upgrade of a software program which you licensed as a single product, the SOFTWARE PRODUCT may be used only as part of that single product package and may not be separated for use on more than one computer.









9. OEM Product Support. Product support for the SOFTWARE PRODUCT IS provided by TesCom. For product support, please call TesCom Should you have any questions concerning this, please refer to the address provided in the documentation.

10. No Liability for Consequential Damages. In no event shall TesCom or its suppliers be liable for any damages whatsoever (including, without limitation, incidental, direct, indirect special and consequential damages, damages for loss of business profits, business interruption, loss of business information, or other pecuniary loss) arising out of the use or inability to use this TesCom product, even if TesCom has been advised of the possibility of such damages. Because some states/countries do not allow the exclusion or limitation of liability for consequential or incidental damages, the above limitation may not apply to you.

11. Indemnification By You. If you distribute the Software in violation of this Agreement, you agree to indemnify, hold harmless and defend TesCom and its suppliers from and against any claims or lawsuits, including attorney's fees that arise or result from the use or distribution of the Software in violation of this Agreement.

TesCom
20200 Algreg St
Pflugerville, TX 78660
U. S. A.

9 Part Numbers

| Ts2 P/N (GP ID) | Description | Photo |
|--|---|---|
| Ts2 (Ts2) | Ts2 w/4-hour holdover |  |
| Ts2e (Ts2e) | Ts2 w/8-hour holdover |  |
| Ts2RKM19 (Ts2RKM19) | Kit, Rackmount, 19" |  |
| 007-02319-000 (007-02319-000) | Kit, Standard Antenna e/w L1 band, 5VDC, 30dB antenna, 50ft RG58 cable, antenna retaining collar/pole mount, L mount bracket, hardware |  |
| 007-02534-000 (007-02534-000) | Kit, Lightning Arrester e/w PolyPhaser arrester, arrester mount bracket, 50ft RG58 cable, non-conductive electrical box, sealant, hardware |  |
| ? | Supply, Power, Commercial, 48VDC | |
| Ts2 OPT-Pxx | OPTION- XXX PTP Clients | |
| Ts2 OPT-Pxy | OPTION- Xxy PTP Clients | |
| TS2-GNSS | Antenna, patch |  |
| VIC-100 (8060) | Antenna, L1 Band, 5VDC, 30dB Gain, TNC |  |
| 8063 (8063) | Collar, antenna retaining/pole mount | |
| 039-01525-002 (8061) | Arrester, Lightning, PolyPhaser |  |
| 8071 (8071) | Bracket, PolyPhaser mount | |
| 8065 (8065) | AC adaptor |  |
| | | |
| Please visit https://tescomusa.com/collections/gps-clock-accessories | | |

10 Glossary

Acronyms and Abbreviations

| | |
|-----------|--|
| 1PPS | Pulse Per Second |
| 1RU | 1 Rack Unit, 1.75 inches or 44.45 millimeters |
| API | Application Program Interface |
| ASCII | American Standard Code for Information Interchange |
| BaseT | Megabits / second Transferred over CAT5 cable |
| BC | Boundary Clock |
| BMCA | Best Master Clock Algorithm |
| BNC | Bayonet Neill-Concelman connector |
| CAT5 | Category 5 cable |
| CLI | Command Line Interface |
| C-RAN | Cloud-Radio Access Network |
| DHCP | Dynamic Host Configuration Protocol |
| DNS | Domain Name Server |
| DST | Daylight Savings Time |
| E2E | End to End delay measurement mechanism |
| ESD | Electrostatic Discharge |
| ETH | Layer 2 network communication for PTP messages |
| FTP | File Transfer Protocol |
| FW | Firmware |
| GC | Gateway Clock |
| GM | Grand Master |
| GNSS | Global Navigation Satellite System |
| GPS | Global Position System |
| HMI | Human Machine Interface |
| HTTP | HyperText Transfer Protocol |
| IEEE | Institute of Electrical and Electronics Engineers |
| IPv4 | Internet Protocol version 4 |
| IPv6 | Internet Protocol version 6 |
| LAN | Local Area Network |
| LED | Light-emitting Diode |
| MAC | Media Access Control address |
| Mbps | Megabits per second |
| MGMT Port | Management Port |
| MHz | Megahertz Frequency |
| Mini-USB | Mini Universal Serial Bus |
| MCE | Managed Clock Engine |
| NMEA | National Marine Electronics Association |
| NV | Nonvolatile Memory |
| OC | Ordinary Clock |
| OCXO | Oven Controlled Crystal Oscillator |
| P2P | Peer to Peer delay measurement mechanism |

| | |
|------|---|
| PLL | Phase Locked Loop |
| PoE | Power over Ethernet |
| PTP | Precise Time Protocol |
| PWR | Power |
| RF | Radio Frequency |
| RU | Rack Unit |
| RMC | Recommended Minimum data for GPS, Sentence C from NMEA |
| SFP | Small Form-Factor Pluggable transceiver |
| SFTP | SSH File Transfer Protocol or Secure File Transfer Protocol |
| SMA | SubMiniature version A connector |
| SNMP | Simple Network Management Protocol |
| SSH | Secure Shell cryptographic network protocol |
| ToD | Time of Day |
| TTL | Transistor-transistor Logic |
| TZ | Time Zone |
| UDP | User Datagram Protocol, IPv4. Layer 3 network communication |
| UDP6 | User Datagram Protocol, IPv6. Layer 3 network communication |
| UIP | User Interface Processor |
| UTC | Coordinated Universal Time |
| VAC | Voltage Alternating Current |
| VDC | Voltage Direct Current |
| WAN | Wide Area Network |
| XML | eXtensible Markup Language |
| ZDA | Data and Time from GPS, NMEA standard |

11 References

- [1] IEEE1588-2008 IEEE Standard for a Precision Clock Synchronization Protocol for Networked Measurement and Control Systems
- [2] ITU-T G.703 V11, Physical/electrical characteristics of hierarchical digital interfaces
- [3] M88 Module Design Manual
- [4] ITU-T G.8261 Timing and synchronization aspects in packet networks
- [5] ITU-T G.8265.1 Precision time protocol telecom profile for frequency synchronization
- [6] ITU-T G.703 Transmission Systems and Media, Digital Systems and Networks
- [7] C37.238-2011 IEEE Standard Profile for Use of IEEE 1588 Precision Time Protocol in Power System Applications

12 Contact

| | |
|---|---|
| TesCom Headquarters | |
| 20200 Algreg St. Pflugerville TX 78660 U. S. A. | |
| Sales Support | |
| Phone: +1 (800) 888-1978 | Email: sales@tescomusa.com |
| Technical Support | |
| Phone: +1 (800) 888-1978 | Email: service@tescomusa.com |