

Note: Measurements are in inches.

DUSTY'S
RUSTIC ROLLING DOORS

Part: Spoke Wheel Hanger

Scale: 1:1

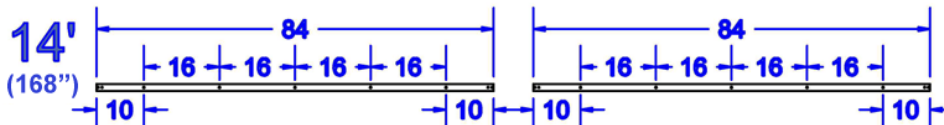
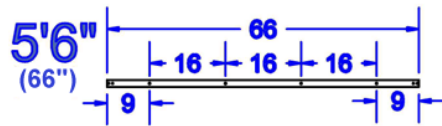
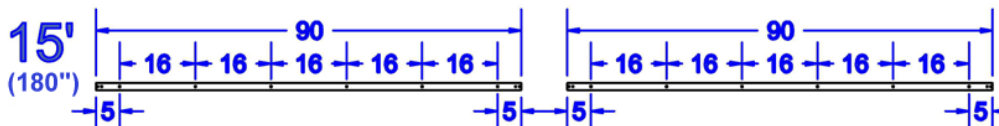
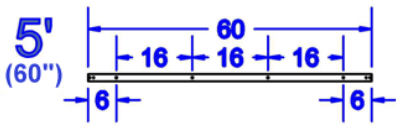
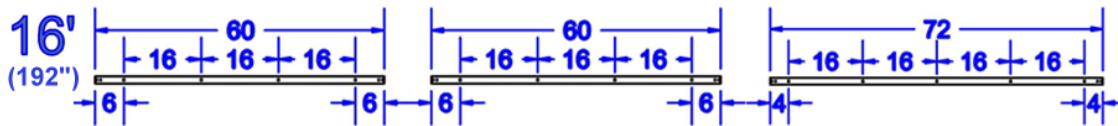
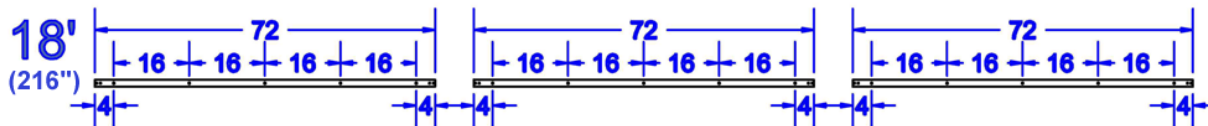
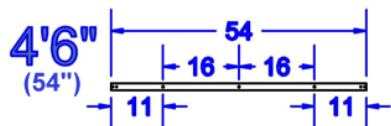
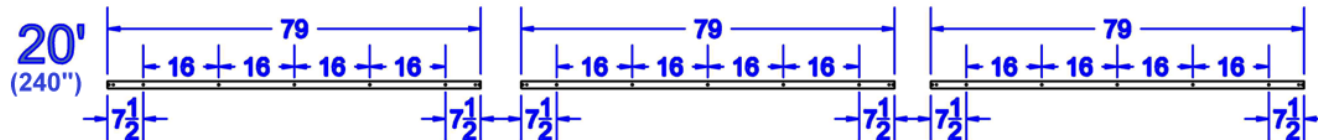
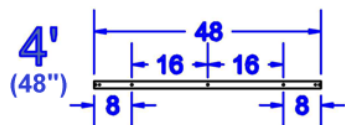

Note: Measurements are in inches.

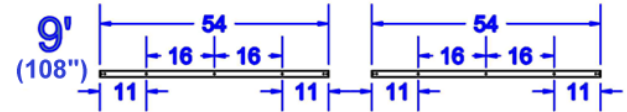
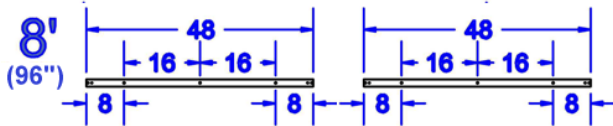
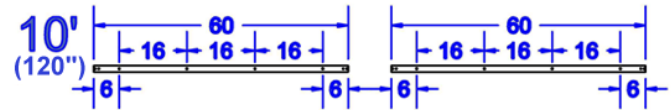
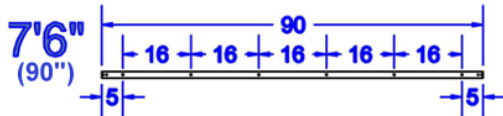
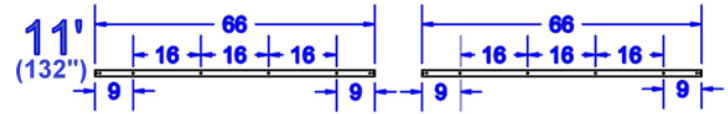
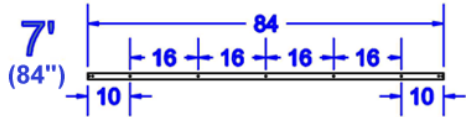
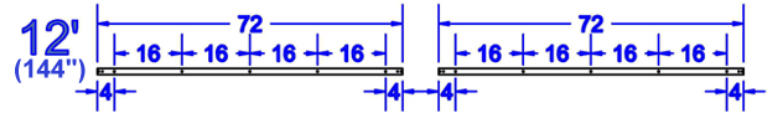
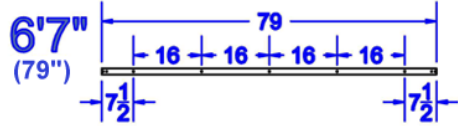
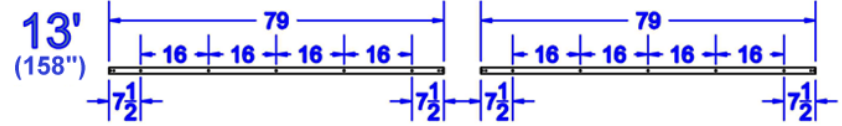
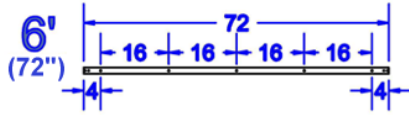

Note: Measurements are in inches.

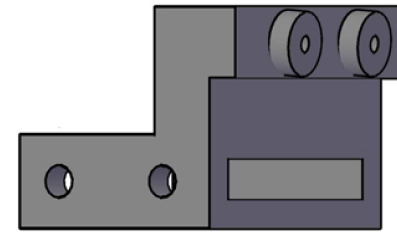
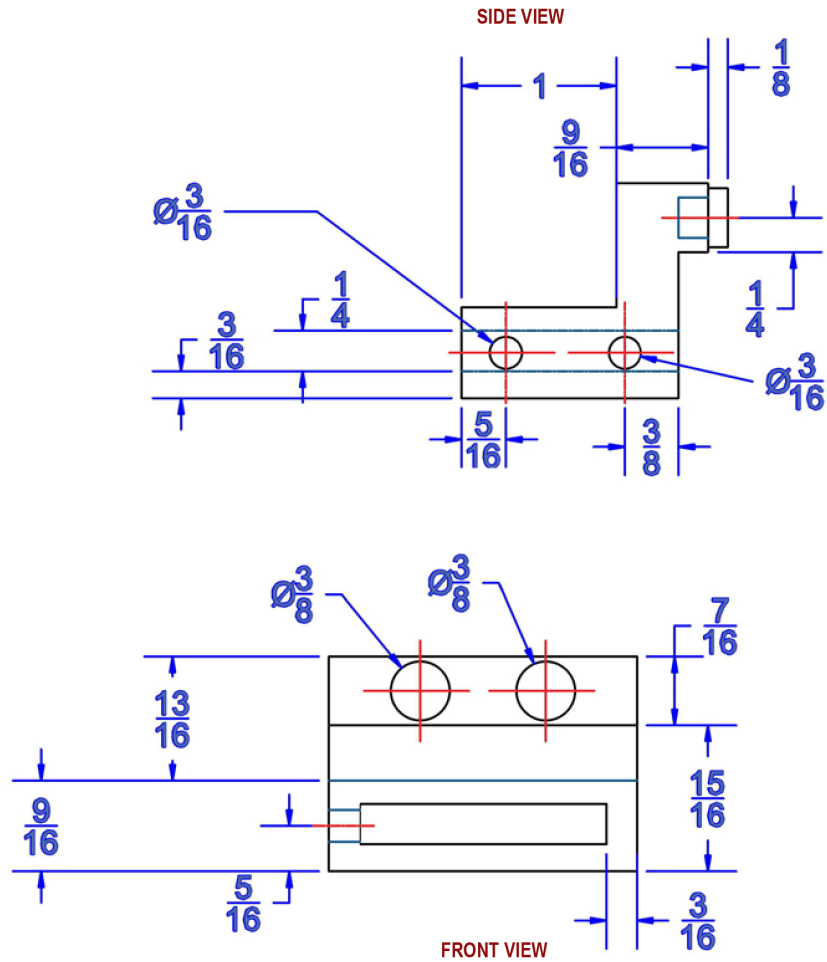

NOTE:
 Supplied with the following:
 2 - $\frac{1}{4}$ " (M6 x 6) Set Screw
 1 - 3mm Hex (Allen) Wrench

Note: Measurements are in inches.

DUSTY'S
 RUSTIC ROLLING DOORS

Part: Door Stopper

Scale: 1:1

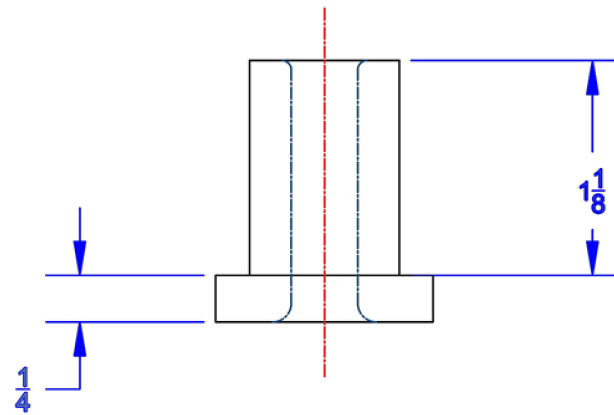
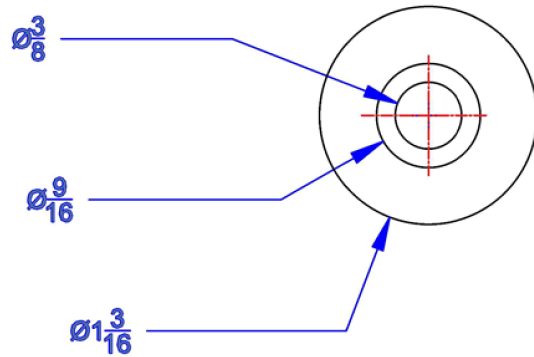
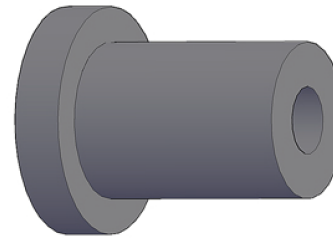
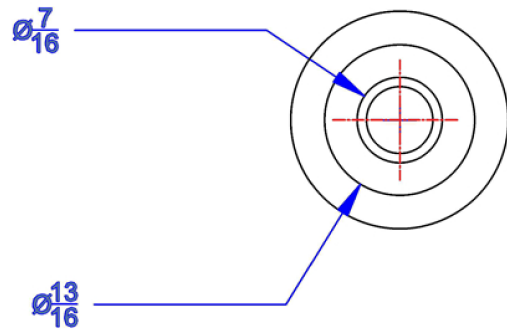

Note: Measurements are in inches.

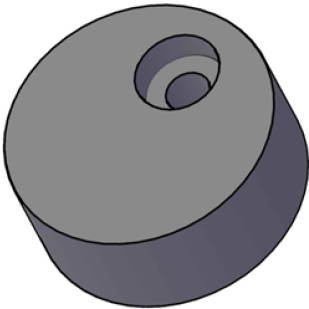
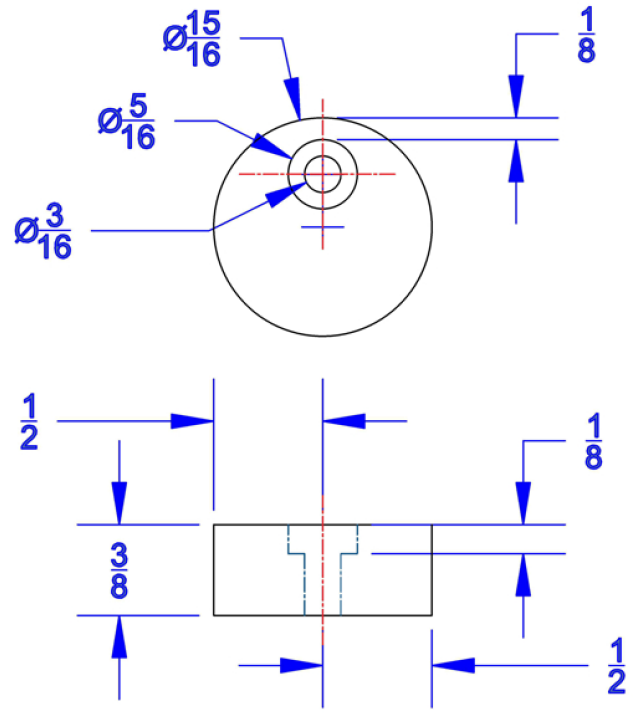

NOTE:
 Supplied with the following:
 1 - 3/4" #7 Wood Screw

Note: Measurements are in inches.



Part: Anti-Jump Pad

Scale: 1:1

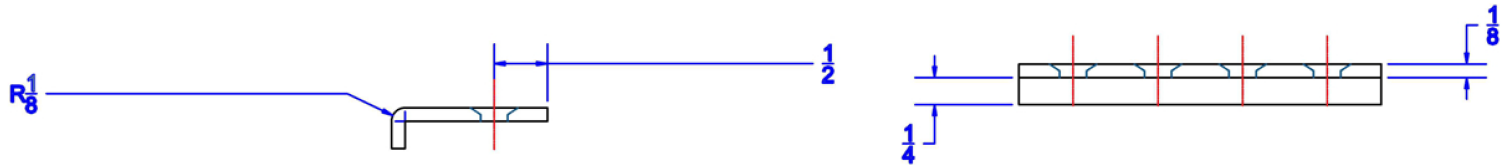
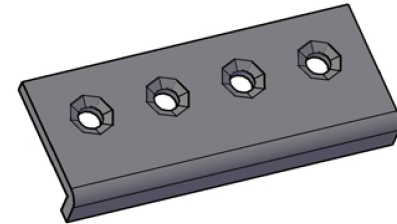
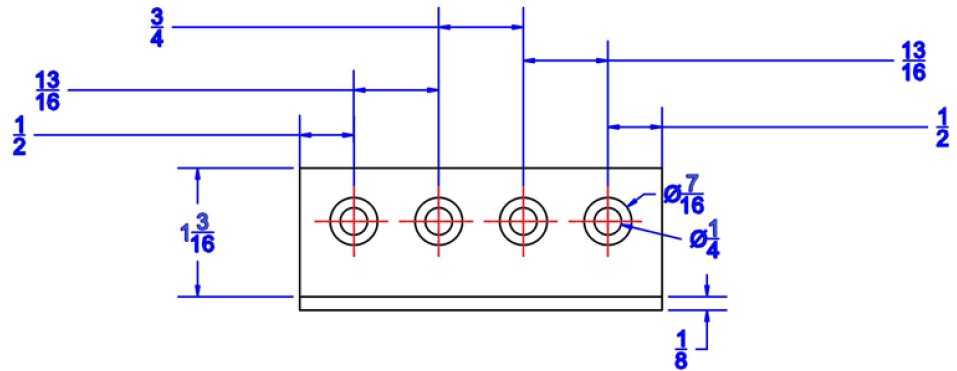

NOTE:

- Supplied with the following:
- 4 – Flat Head Hex (Allen) Screws
- 4 – 6 mm Nuts
- 1 – 4 mm Hex (Allen) Wrench

Note: Measurements are in inches.



Part: Junction Plate

Scale: 1:1

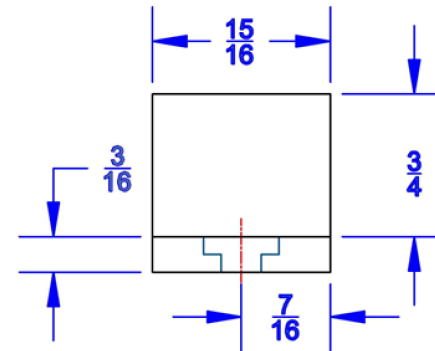
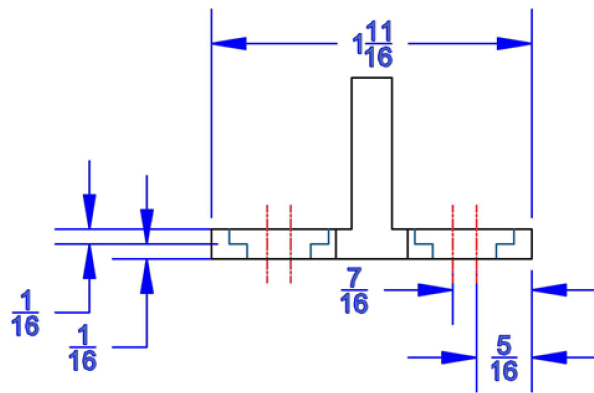
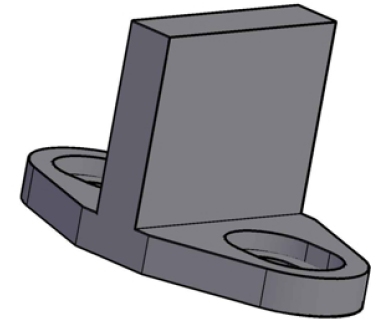
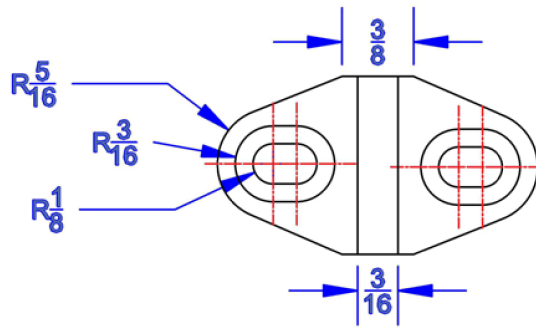

NOTE:
 Supplied with the following:
 2 - 1" #8 Sheet Metal Screw
 2 - 1-3/16" (6 x 30) Plastic Anchor

Note: Measurements are in inches.

DUSTY'S
 RUSTIC ROLLING DOORS

Part: Floor Guide

Scale: 1:1

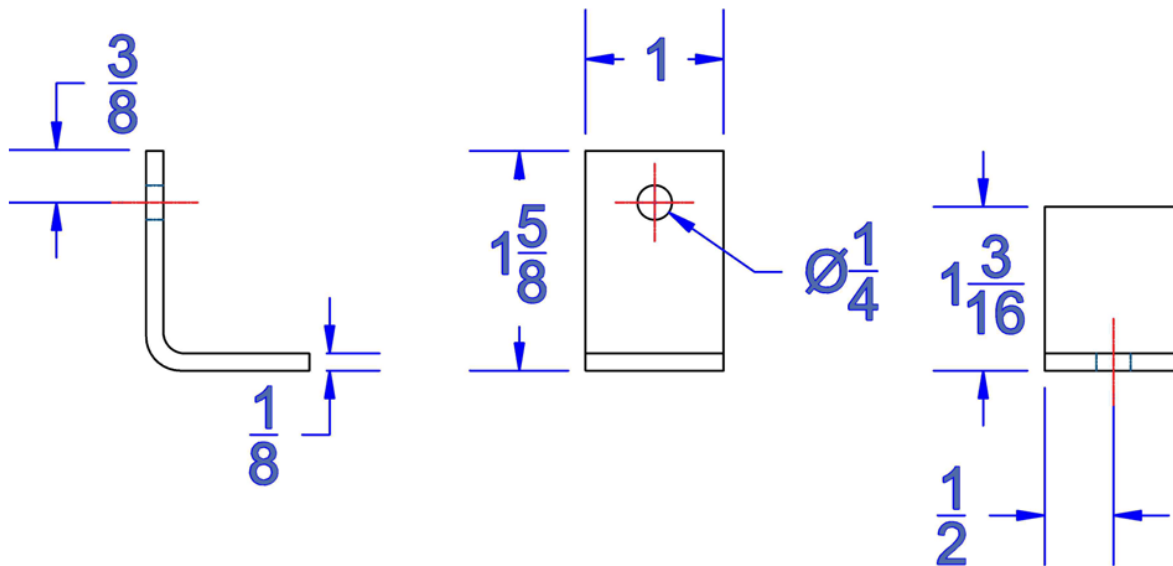

NOTE:

Supplied with the following:

- 1 – 16mm M6 Socket Button Head Screw (3/4" long)
- 1 – M6 Flat Washer (1/2" across)
- 1 – M6 Nut (3/8" across)
- 1 per set of 2 brackets – 4 mm Hex (Allen) Wrench (5/32")

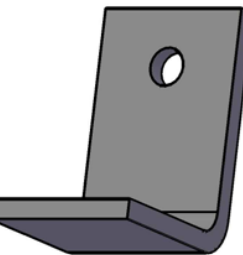

Note: Measurements are in inches.



Part: Anti-Jump Bracket for Single-Track Bypass Hangers

Scale: 1:1

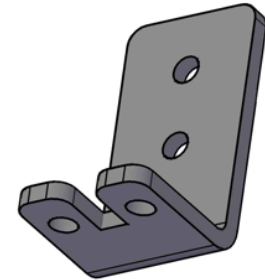
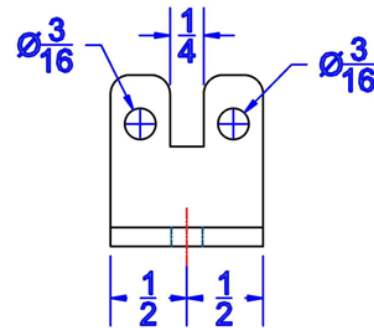
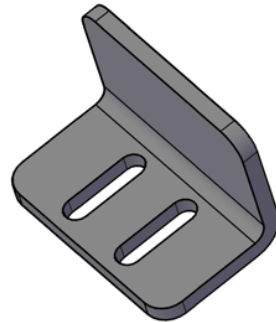
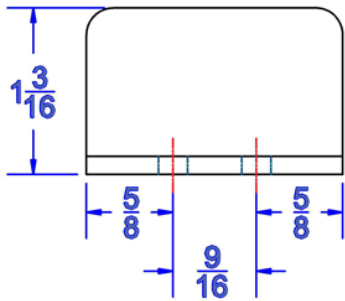
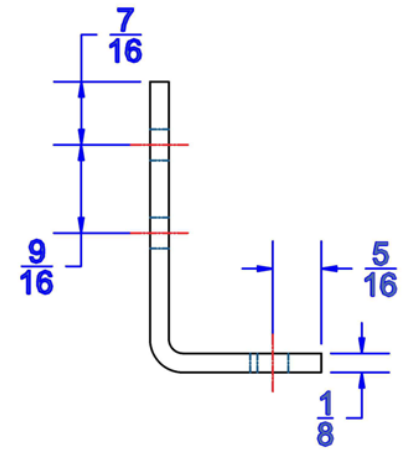
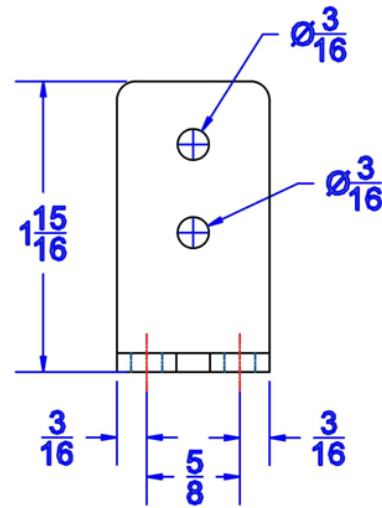
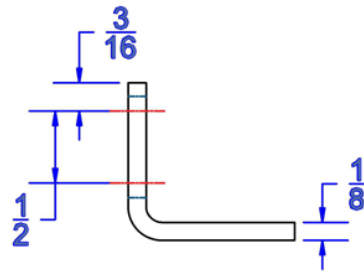
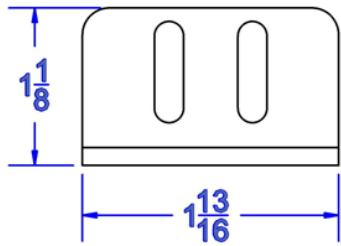

NOTE:

Supplied with the following:

- 2 – M5 Phillips Truss Head Screw (1/2" overall length)
- 2 – M5 Nut (5/16" across)
- 2 – 6x30mm Plastic Anchor (1" long)
- 2 – M6 x 24 mm Sheet Metal Screw (1" long)

Note: Measurements are in inches.



Part: Outer Door Floor Guide for Single-Track Bypass Hardware Kit

Scale: 1:1