

Note: Measurements are in inches.

DUSTY'S
RUSTIC ROLLING DOORS

Part: Spoke Wheel Hanger

Scale: 1:1

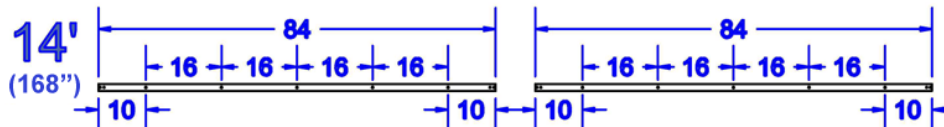
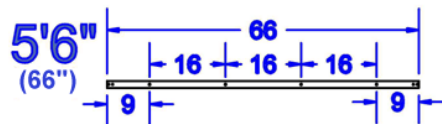
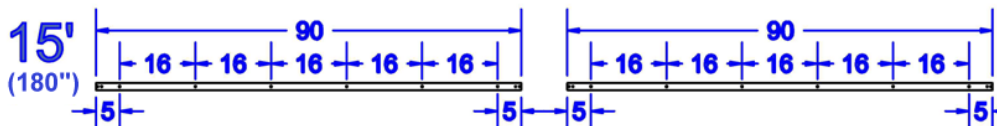
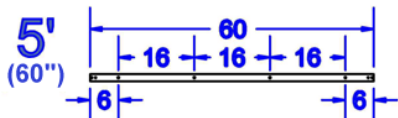
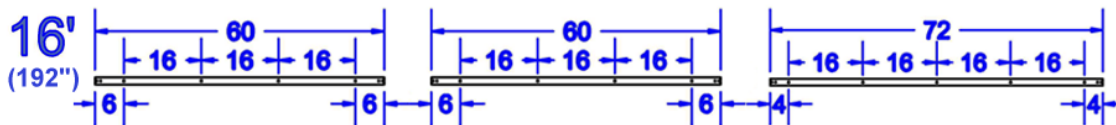
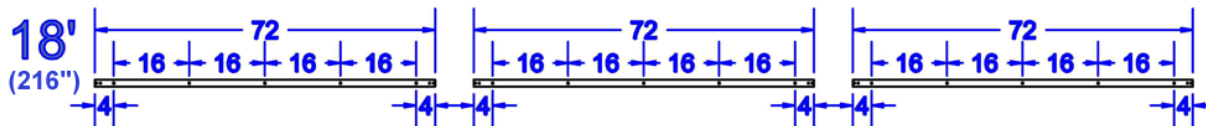
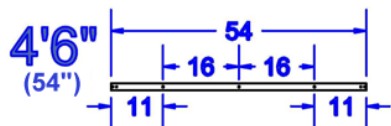
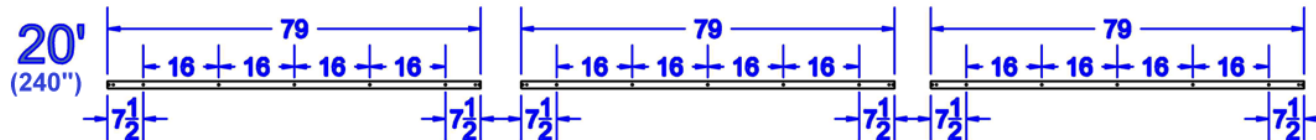
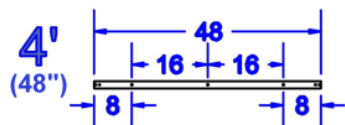

Note: Measurements are in inches.

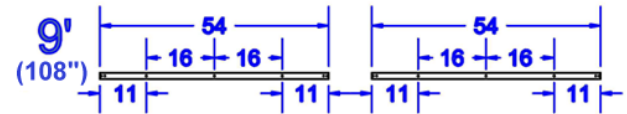
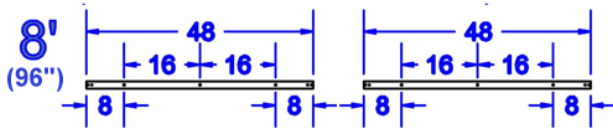
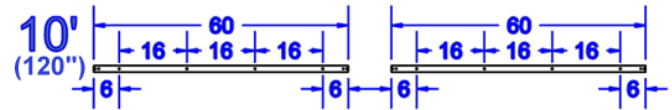
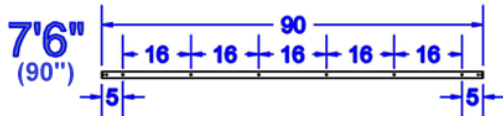
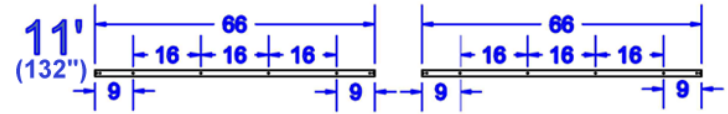
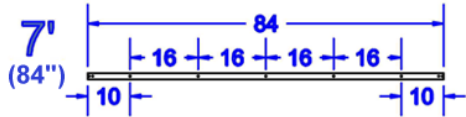
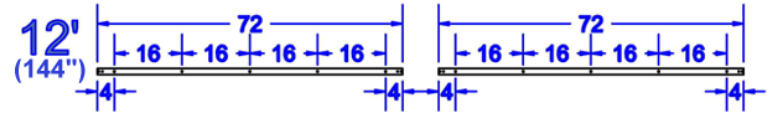
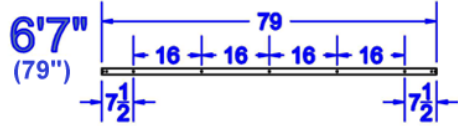
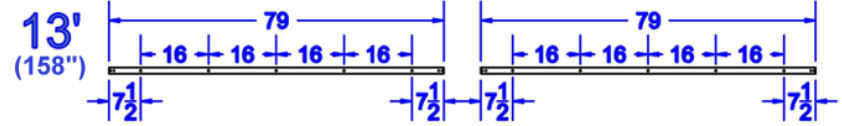
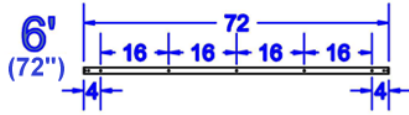

Note: Measurements are in inches.

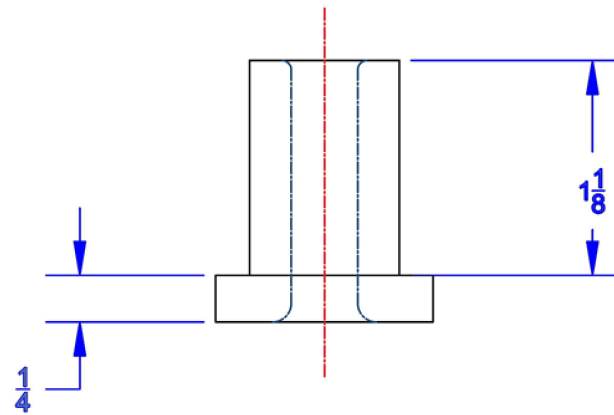
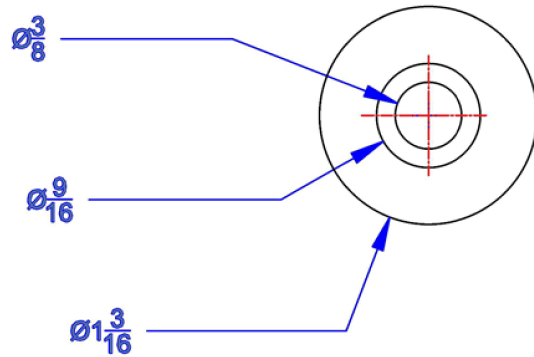
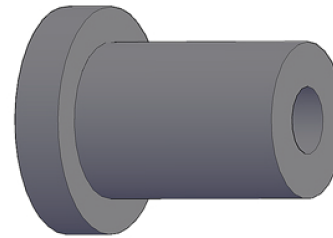
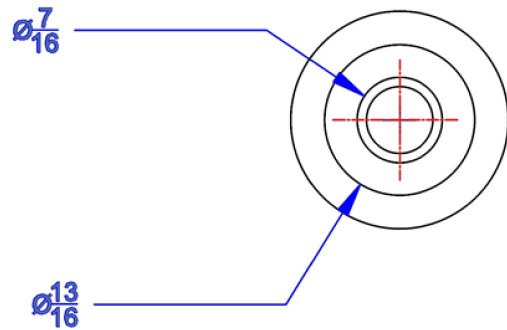

Note: Measurements are in inches.

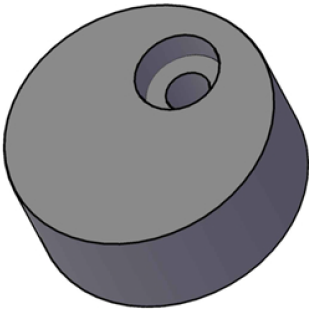
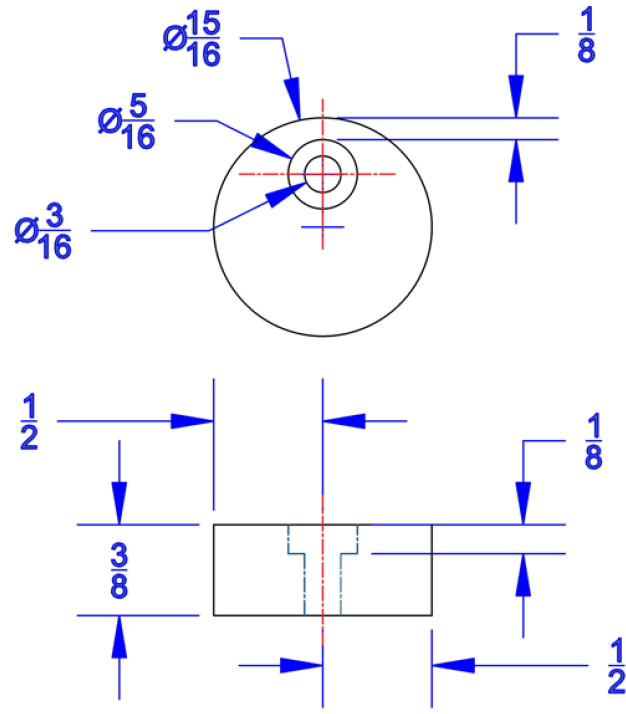

NOTE:
 Supplied with the following:
 1 - 3/4" #7 Wood Screw

Note: Measurements are in inches.



Part: Anti-Jump Pad

Scale: 1:1

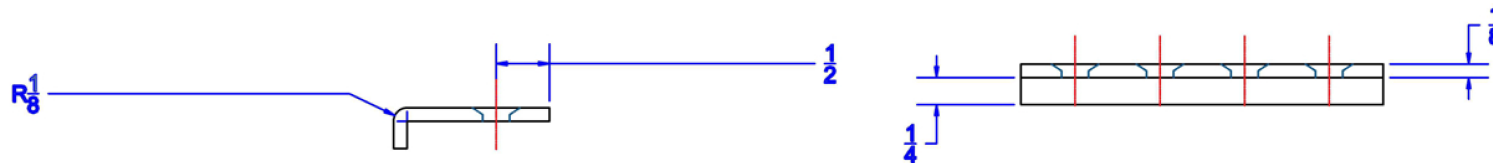
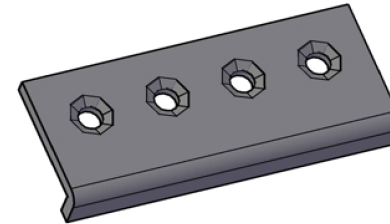
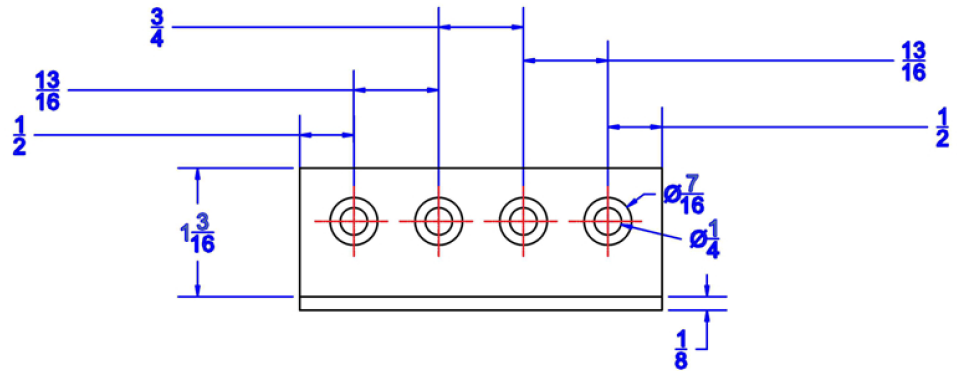

NOTE:

- Supplied with the following:
- 4 – Flat Head Hex (Allen) Screws
- 4 – 6 mm Nuts
- 1 – 4 mm Hex (Allen) Wrench

Note: Measurements are in inches.



Part: Junction Plate

Scale: 1:1

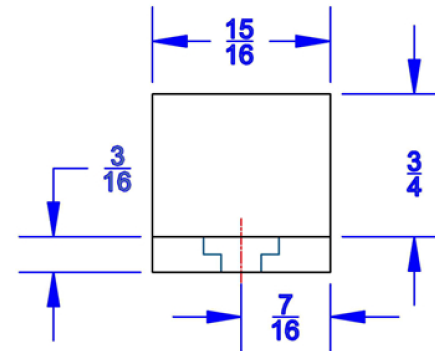
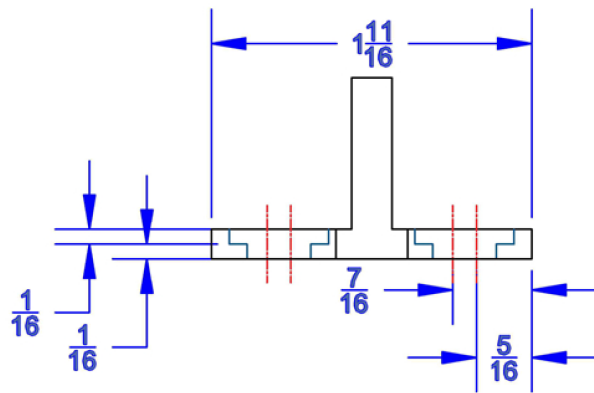
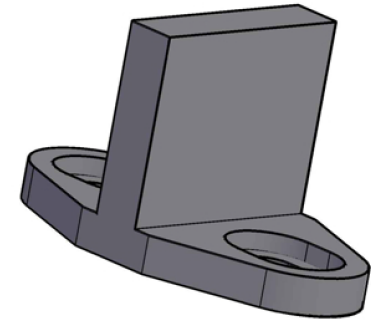
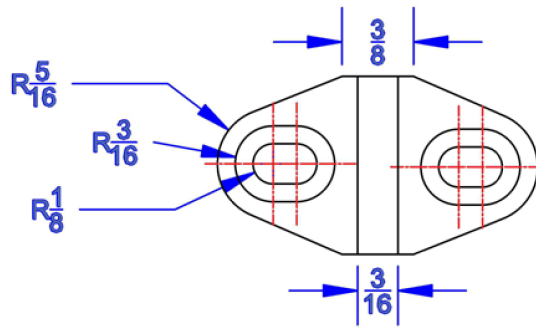

NOTE:
 Supplied with the following:
 2 - 1" #8 Sheet Metal Screw
 2 - 1-3/16" (6 x 30) Plastic Anchor

Note: Measurements are in inches.

DUSTY'S
 RUSTIC ROLLING DOORS

Part: Floor Guide

Scale: 1:1