

Note: Measurements are in inches.

**RUSTIC**  
ROLLING DOORS

Part: Eiffel Tower

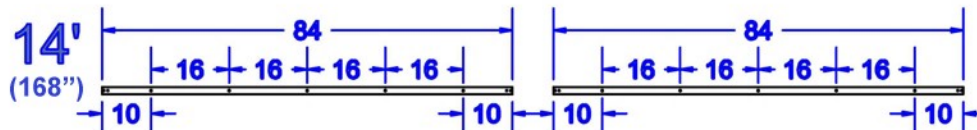
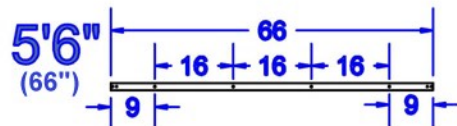
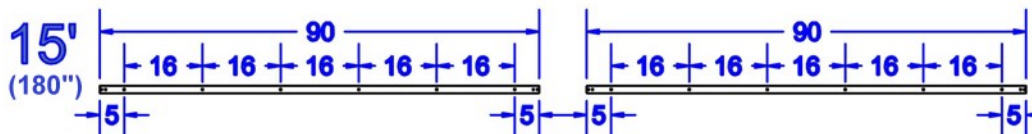
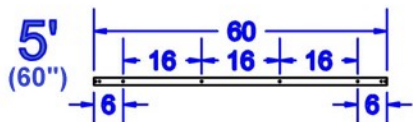
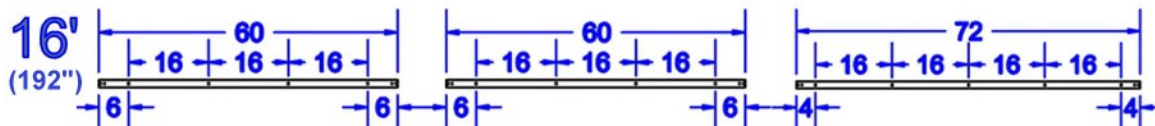
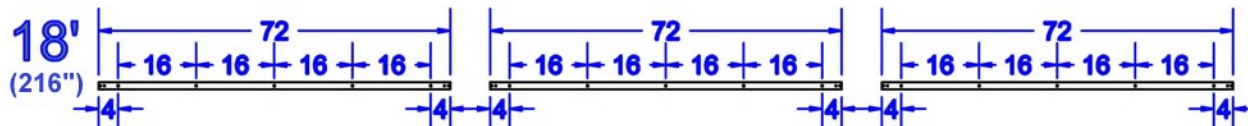
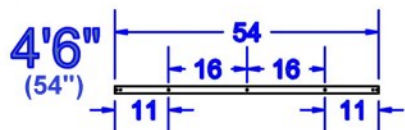
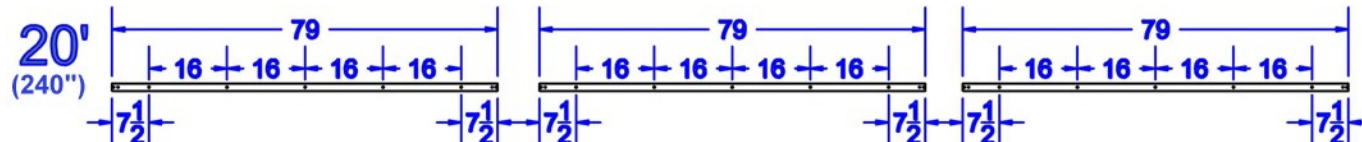
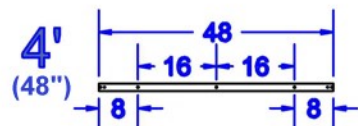

Note: Measurements are in inches.

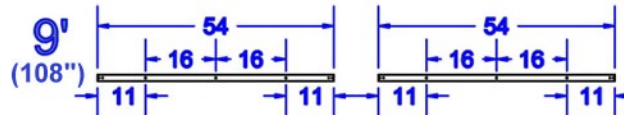
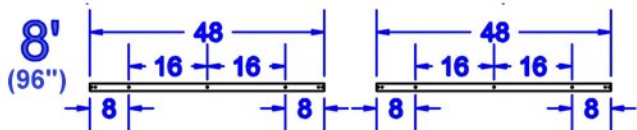
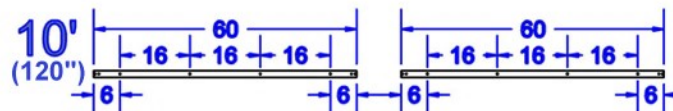
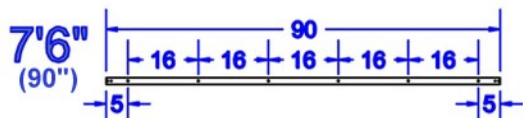
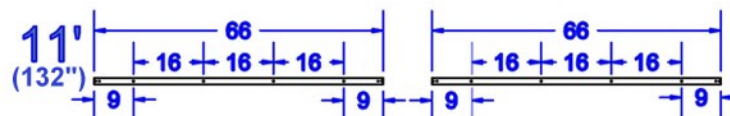
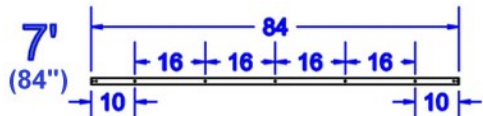
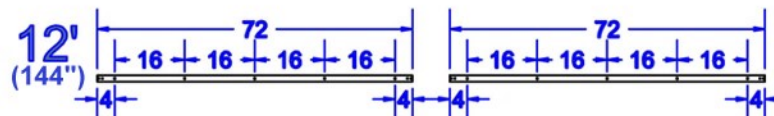
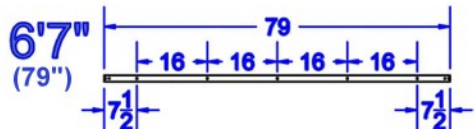
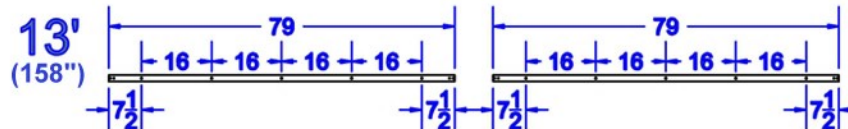
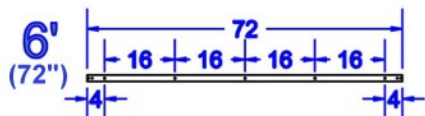

Note: Measurements are in inches.

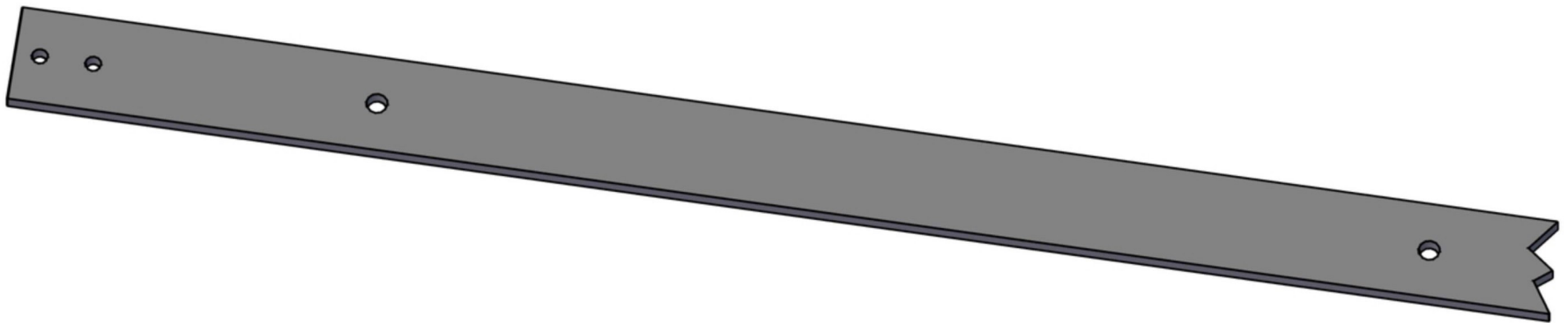
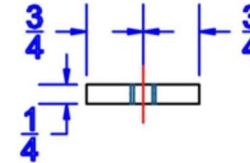
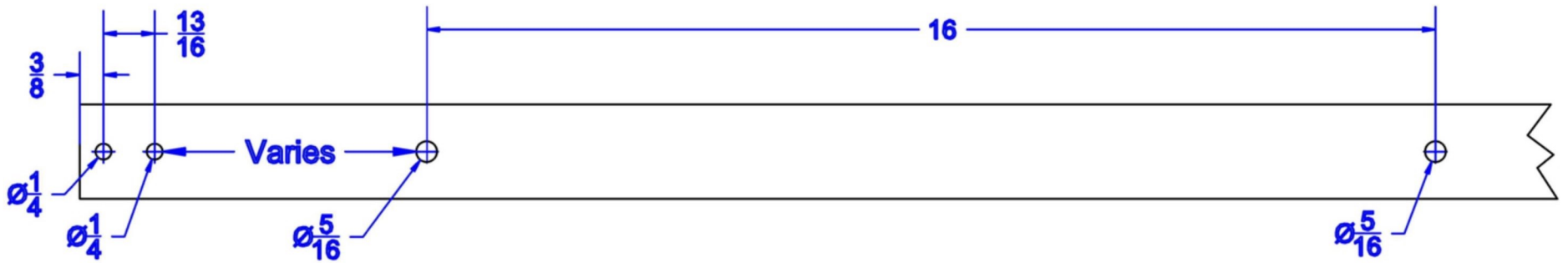

Note: Measurements are in inches.

**RUSTIC**  
ROLLING DOORS

Part: Track

Scale: 1:1

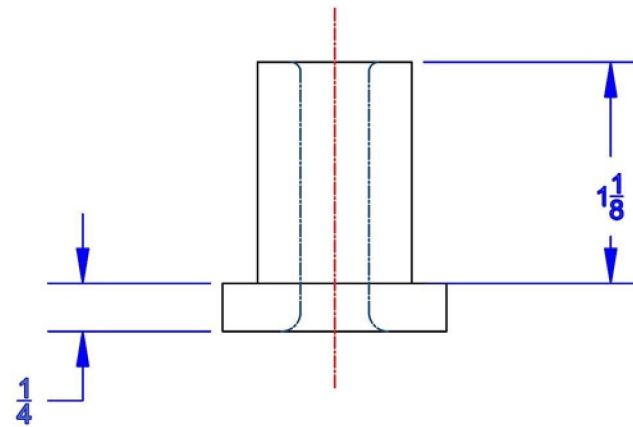
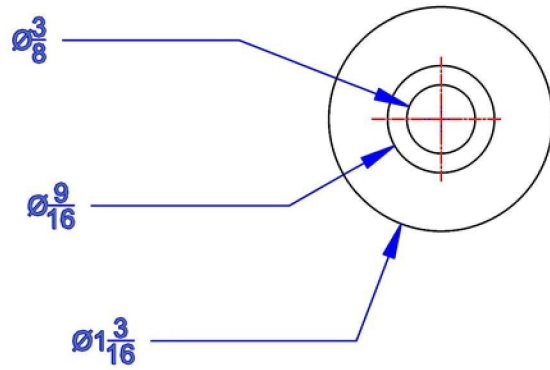
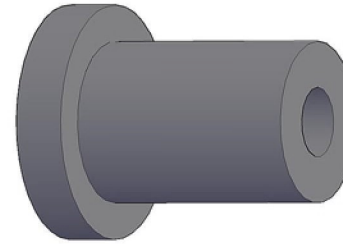
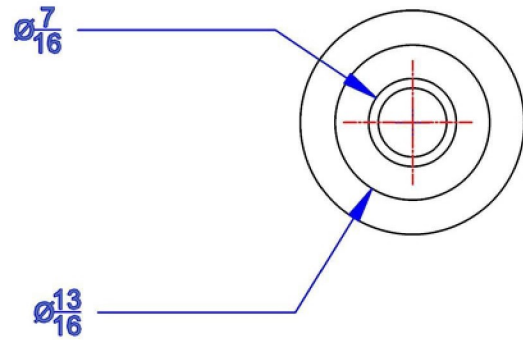

Note: Measurements are in inches.

**RUSTIC**  
ROLLING DOORS

Part: Spacer

Scale: 1:1

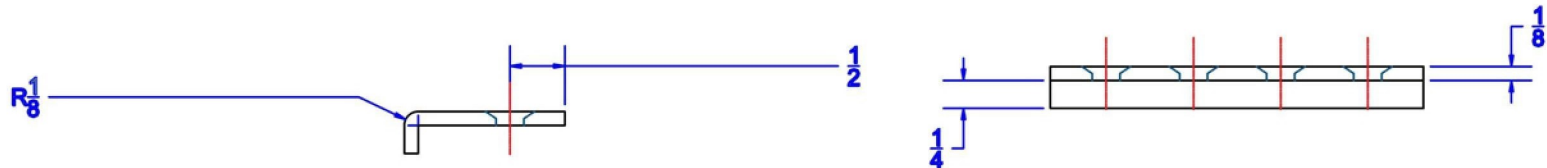
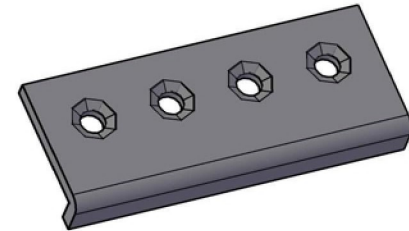
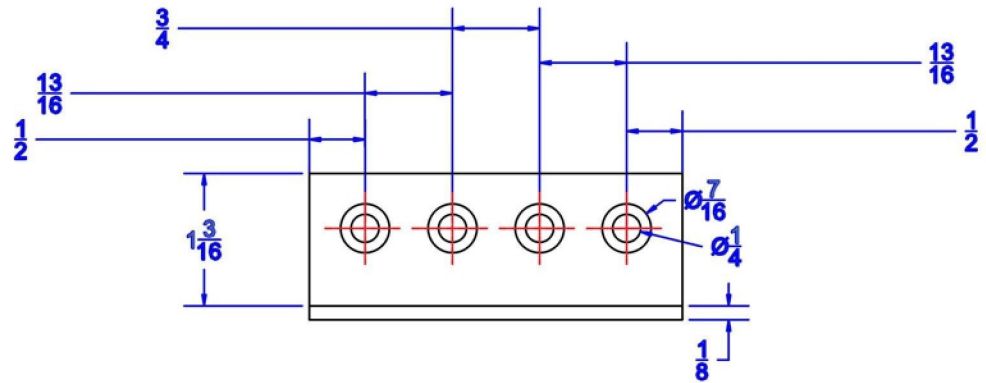

NOTE:  
 Supplied with the following:  
 4 - Flat Head Hex (Allen) Screws  
 4 - 6 mm Nuts  
 1 - 4 mm Hex (Allen) Wrench

Note: Measurements are in inches.

**RUSTIC**  
 ROLLING DOORS

Part: Junction Plate

Scale: 1:1

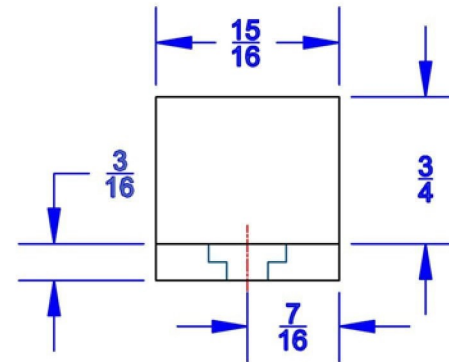
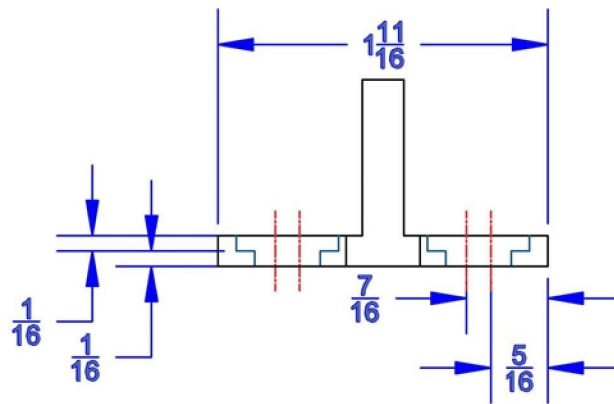
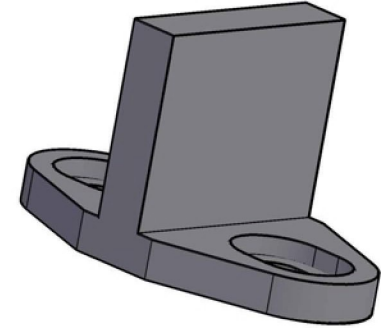
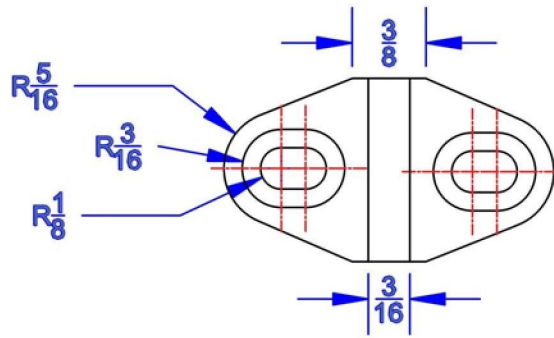

NOTE:  
 Supplied with the following:  
 2 - 1" #8 Sheet Metal Screw  
 2 - 1-3/16" (6 x 30) Plastic Anchor

Note: Measurements are in inches.

**RUSTIC**  
 ROLLING DOORS

Part: Floor Guide

Scale: 1:1

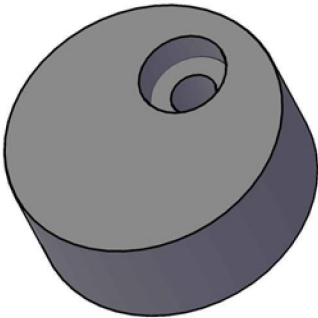
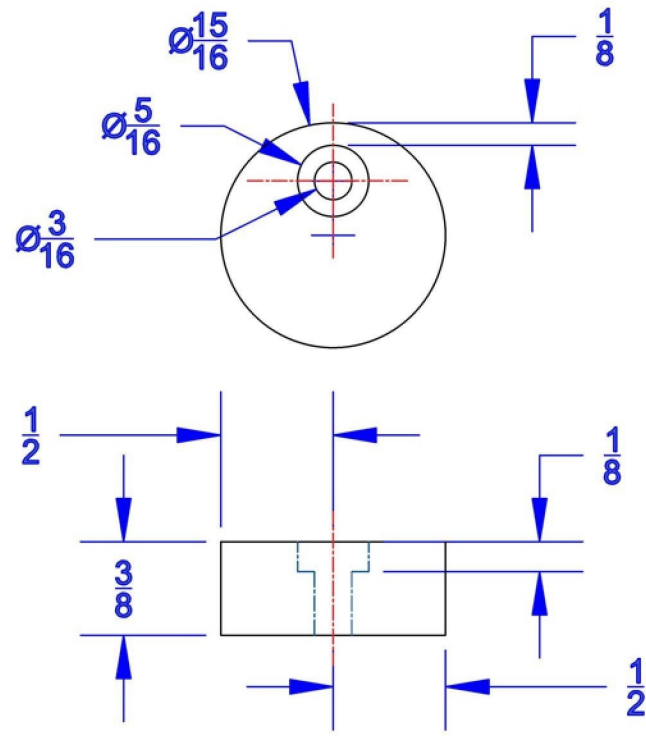

NOTE:  
 Supplied with the following:  
 1 - 3/4" #7 Wood Screw

Note: Measurements are in inches.



Part: Anti-Jump Pad

Scale: 1:1



