



# **DUSTY'S**

**RUSTIC ROLLING DOORS**

**Single-Track Bypass  
Barn Door Hardware Kit  
Installation Manual**

# Safety Warnings and Cautions

**IMPORTANT:** Rustic Rolling Doors cannot anticipate every possible circumstance that might involve a potential hazard. Therefore, the warnings and cautions in this manual are not all inclusive. Use care and good judgment in the installation and operation of the hardware and door(s). Always take precautions to protect yourself and others. Follow all applicable national, state, local, and industry-specific safety regulations and standards.



## **WARNINGS—FAILURE TO FOLLOW WARNINGS MAY RESULT IN SERIOUS INJURY OR DEATH!**

- Read this manual carefully before attempting the installation.
- Do NOT use excessive force or speed when opening or closing the door(s).
- Always properly install the Anti-Jump Pads/Brackets to the door(s). Anti-Jump Pads/Brackets are REQUIRED for the safe operation of the door(s). They are designed to help prevent the door(s) from jumping off the track.
- Always properly install the Door Stoppers on both ends of the track. Door Stoppers are REQUIRED for the safe operation of the door(s). They are designed to help prevent the door(s) from coming off the track.
- When using power tools, always read and follow instructions in the power tools' manuals for their safe operation.
- Prior to using power tools, inspect the tool and attachments, such as bits, for damage. Do NOT use if damaged.
- When using power tools, always wear safety glasses and any other appropriate safety items such as hearing protection or gloves.
- When using power tools, take precautions to prevent your hair and clothing from being caught in the tool.
- When using power tools, ensure you have a firm grip on the tool and that you always maintain full control of the tool.
- When drilling, ensure you know the location of live electrical wires. Stay clear of wires, cables, pipes, and any other objects that may endanger you when drilling.
- When cutting or drilling, do NOT use excessive force.
- When cutting or drilling a door, always ensure the door is completely immobilized or clamped in place to prevent any movement that may result in the loss of control of the power tool.
- Always follow proper ladder safety. Read and follow the labels on the ladder. For more details, read about portable ladder safety at the OSHA Web site ([www.osha.gov](http://www.osha.gov)).





## **CAUTIONS—FAILURE TO FOLLOW CAUTIONS MAY RESULT IN BODILY INJURY OR DAMAGE TO ITEMS!**

- Clear your work area of trip hazards.
- Do NOT try to lift heavy objects, such as the door(s), that are heavier than you can safely lift alone. If needed, have a second person help you lift.
- When lifting heavy objects, such as the door(s), always use proper lifting techniques. Do NOT use your back muscles, use your leg muscles to lift.
- When lifting heavy objects, such as the door(s), wear steel-toe safety shoes/boots to help prevent injury if the items are dropped.
- When lifting heavy objects, such as the door(s), ensure you have a secure hold on the object and that you are properly balanced prior to moving.
- Beware of potential pinch points where you can be injured, such as pulleys. Keep hands and fingers away from moving parts.
- Secure hair and secure or remove loose clothing so they do not get caught in the moving components.
- Always use door handles. Do NOT close the door(s) using your hand on the end of the door—doing so can result in your hand or fingers being caught between the door(s) or another object such as moulding or the wall.
- Check your doors periodically to ensure fasteners are tight and everything is functioning as it should. Make any necessary corrections immediately.





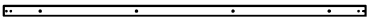
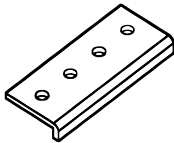
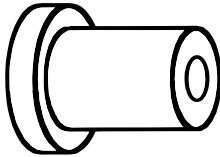

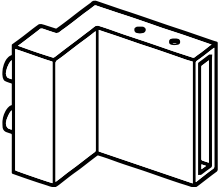
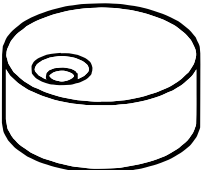
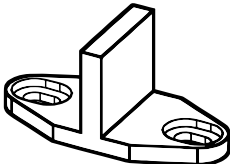
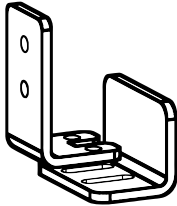
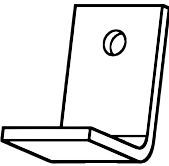
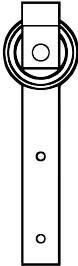
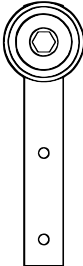
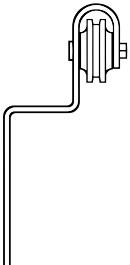
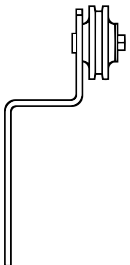
## Disclaimer



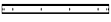

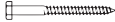
All parts mentioned herein are subject to change without notice. We cannot guarantee the accuracy of the measurements provided. Rustic Rolling Doors assumes no responsibility for any errors that may appear in this document. In no event shall Rustic Rolling Doors be held liable for incidental or consequential damages arising from the use of this document or the hardware described in this document.

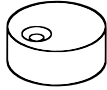
# Component List

		
<p><b>Track</b></p>	<p><b>Junction Plate</b> (If applicable)</p>	<p><b>Spacer</b></p>
		
<p><b>Large Lag Bolt</b></p>	<p><b>Plastic Anchor</b></p>	<p><b>Door Stopper</b></p>
		
<p><b>Anti-Jump Pad</b></p>	<p><b>Floor Guide for Inner Door</b></p>	<p><b>Floor Guide for Outer Door</b></p>
		
<p><b>Anti-Jump Bracket</b></p>	<p><b>Classic Strap Hanger</b> (If applicable)</p>	<p><b>Low-Profile Hanger</b> (If applicable)</p>
		
<p><b>Classic Strap Single-Track Bypass Hanger</b> (If applicable)</p>	<p><b>Low-Profile Single-Track Bypass Hanger</b> (If applicable)</p>	

Before proceeding, it is a good time to take an inventory of the parts to ensure you have everything you need. Refer to the parts table below. If anything is missing, please contact us. Also, review the tools table that follows to ensure you have all the tools you will need for the installation.

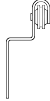
							
<b>Track Length</b>	<b>Flat Track</b>	<b>Junction Plate</b>  (Each comes with 4 Flat Head Screws, 4 Nuts, and 1 Hex Wrench)	<b>Spacer</b>	<b>Large Lag Bolt (3-3/4" long)</b>  (Each comes with a Large Washer (3.4" across) and a Plastic Anchor (2" long))	<b>Door Stopper</b>  (One Hex Wrench is provided regardless of the number of Door Stoppers)	<b>Inner Door Anti-Jump Pad</b>  (Each comes with 1 Wood Screw)	<b>Outer Door Anti-Jump Bracket</b>  (Each comes with 1 Screw (3/4" long), 1 Small Washer (1/2" across), and 1 Small Nut. 1 Hex Wrench comes with every 2 brackets)
4'	1	n/a	3	3	2	2	2
4'6"	1	n/a	3	3	2	2	2
5'	1	n/a	4	4	2	2	2
5' 6"	1	n/a	4	4	2	2	2
6'	1	n/a	5	5	2	2	2
6' 7"	1	n/a	5	5	2	2	2
7'	1	n/a	5	5	2	2	2
7' 6"	1	n/a	6	6	2	2	2
8'	2	1	6	6	2	2	2
9'	2	1	6	6	2	2	2
10'	2	1	8	8	2	2	2
11'	2	1	8	8	2	2	2
12'	2	1	10	10	2	2	2
13'	2	1	10	10	2	2	2
14'	2	1	10	10	2	2	2
15'	2	1	12	12	2	2	2
16'	3	2	13	13	2	2	2
18'	3	2	15	15	2	2	2
20'	3	2	15	15	2	2	2

						
	<b>Inner Door Floor Guide</b>	<b>Outer Door Floor Guide</b>	<b>Inner Door Classic Strap Hanger</b> (If applicable)	<b>Outer Door Classic Strap Single-Track Bypass Hanger</b> (If applicable)	<b>Inner Door Low-Profile Strap Hanger</b> (If applicable)	<b>Outer Door Low-Profile Single-Track Bypass Hanger</b> (If applicable)
<b>Track Length</b>	(Each comes with 2 Wood Screws (1" long) and 2 Plastic Anchors (1-5/16" long))	(For each guide comes with 2 Screws (1-1/16" long), 2 Small Screws (1/2" long), and 2 Small Nuts)	(For each hole in the hanger there will be 1 Long Bolt (2-5/8" long), 1 Large Washer (3/4" across), and 1 Acorn Nut)	(For each hole in the hanger there will be 1 Long Bolt (2-5/8" long), 1 Large Washer (3/4" across), and 1 Acorn Nut)	(For each hole in the hanger there will be 1 Long Bolt (2-5/8" long), 1 Large Washer (3/4" across), and 1 Acorn Nut)	(For each hole in the hanger there will be 1 Long Bolt (2-5/8" long), 1 Large Washer (3/4" across), and 1 Acorn Nut)
4'	1	1	2	2	2	2
4'6"	1	1	2	2	2	2
5'	1	1	2	2	2	2
5' 6"	1	1	2	2	2	2
6'	1	1	2	2	2	2
6' 7"	1	1	2	2	2	2
7'	1	1	2	2	2	2
7' 6"	1	1	2	2	2	2
8"	1	1	2	2	2	2
9'	1	1	2	2	2	2
10'	1	1	2	2	2	2
11'	1	1	2	2	2	2
12'	1	1	2	2	2	2
13'	1	1	2	2	2	2
14'	1	1	2	2	2	2
15'	1	1	2	2	2	2
16'	1	1	2	2	2	2
18'	1	1	2	2	2	2
20'	1	1	2	2	2	2

## Complete Tools and Equipment List

Wrenches	Other
4 mm Hex (Allen) Wrench (included with the Junction Plate and the Outer Door Anti-Jump Bracket)	Clamps
Hex (Allen) Wrench (included with the Door Stopper)	Ladder (Two ladders for some applications)
10 mm Combination Wrench	Long Level (4' or longer)
1/2" (13 mm) Wrench	Pencil
5/8" (16 mm) Wrench	Phillips Screwdriver
5/16" Wrench	Ruler
11/16" (17 mm) Wrench	Tape Measure
<b>Power Tools</b>	Safety Glasses (and any other appropriate safety gear such as safety boots, hearing protection, and gloves). (Read and follow requirements found in the manuals for your power tools.)
Electric Drill	
1/8" Drill Bit	
7/32" Drill Bit	
11/64" Drill Bit (or 3/8" and 5/16" Masonry Drill Bits for concrete wall installations)	<b>Optional</b>
27/64" Drill Bit	Speed Square (Optional)
Router (Only required if cutting a door channel)	Stud Finder (Optional)
1/4" Cutter Bit (Only required if cutting a door channel)	
Saw (can be a circular saw, a table saw, or a hand saw)	



## Attaching the Junction Plate

If your track is 7'6" or less, then skip ahead to the **Preparing Your Doorway** section. If your setup requires a total track length greater than 7'6", then you will need to connect two or more tracks together to obtain the proper length.

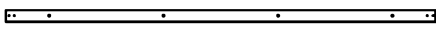
### PARTS

Drawings	Quantity	Description
	2 or more, as required	Tracks

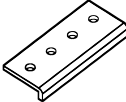
Each Junction Plate set includes the following:

Drawings	Quantity	Description
	1	Junction Plate
	4	Flat Head Hex (Allen) Screws (5/8" long)
	4	Nuts (3/8" across)

### TOOLS AND EQUIPMENT

- 4 mm Hex (Allen) Wrench (Included)
- 10 mm Wrench

### STEPS

1. Align the two holes at one end of the Junction Plate with the two holes at the end of a Track.
2. Attach the Junction Plate to the track using two Flat Head Hex (Allen) Screws and two Nuts (finger tight).

**Note:** The lip of the Junction Plate must be aligned with the bottom edge of the Track. See the illustration below.

3. Align the other two holes of the Junction Plate with two holes at the end of another Track.
4. Attach the Junction Plate to the additional Track using two Flat Head Hex (Allen) Screws and two Nuts (finger tight).
5. Using the 4 mm Hex (Allen) Wrench and the 10 mm Wrench, firmly tighten all screws and nuts.

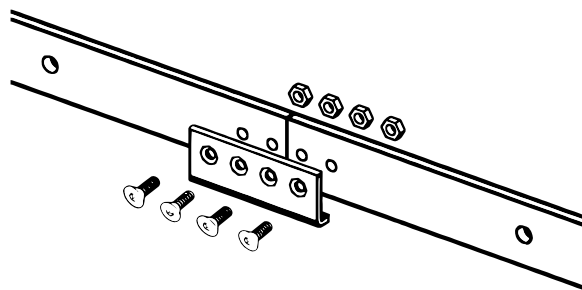

6. Repeat the above steps if additional Junction Plates are needed.

# Preparing the Doorway

## MATERIALS

Header board (not included) may be needed.

## TOOLS AND EQUIPMENT

- Pencil
- Long Level (4' or longer)
- Ruler
- Tape Measure
- Ladder (Two ladders for some applications)
- Stud Finder (Optional)
- Speed Square (Optional)

## STEPS

### Find the Wall Stud Locations

**Note:** This section describes what is necessary when installing to a standard wall with studs covered by drywall or paneling. It does not apply to other walls that do not have studs, such as a concrete wall.

The included tracks have predrilled holes that are 16” apart to match up with the standard spacing for wall studs; however, depending on your wall and the door opening you may find that your studs do not align with the predrilled holes. In those cases, we highly recommend that you attach a header board (not included) on top of your wall. The board must be secured to the studs. Later, the track is mounted to the board.

**Note:** Do NOT use the included plastic anchors as drywall anchors. They are designed for concrete wall applications only. We do NOT recommend the use of drywall anchors.

 <b>CAUTION</b>	<ul style="list-style-type: none"> <li>• Two people are recommended for this stage, especially for longer track lengths. Safety First—Do NOT try to do these steps on your own, particularly if a ladder is required.</li> <li>• Read and follow all the warnings and cautions found at the beginning of this manual.</li> </ul>
---	--

1. Find and mark the location of the wall studs along the length of your mounting location.  
**Note:** A Stud Finder tool may be helpful for this step, but other methods of your choice may be used.
2. Determine where the track will be aligned with your door opening.
3. Hold up the track to the desired mounting location to see if the predrilled holes on the track will align with the studs. If not, proceed to step 4. Otherwise, proceed to the Drawing the Horizontal Reference Line section.
4. Obtain a solid piece of lumber to act as a header board. It should be longer than the track and at least 6” tall.  
**Note:** A standard 1” (3/4” actual) thickness should be sufficient for most applications; however, ensure it is solid wood and NOT particle board or MDF. If needed, a thicker 2” (1-1/2” actual) board can be used instead. You may want to paint this board prior to installation.
5. Securely attach the header board to the wall on the studs.



## Drawing the Horizontal Reference Line

**Important:** Always check your measurements. The instructions in this manual require that the top and bottom of the door are flat and even all the way across so that the measurements you take can be precise and so proper spacing can be maintained for the components. The instructions also assume that the doors you are using are of equal height.

**Tip:** Having a second person for this stage may be helpful.

1. Measure the height of the door you will be installing.

**Note:** This measurement is not the mounting height or the height of the doorway. It is only the height of the door.

2. Determine the height of the line that needs to be drawn on the wall (or header board) by adding 1-7/8" to the measurement of the height of the door.
3. Check to see if your floor is level under the mounting location. If it is not level, find the highest point of the floor over which the door(s) will travel. This is the point where you should measure from in the next step.
4. Using the measurement you computed, measure vertically that distance from the floor and make a mark on the wall (or header board).

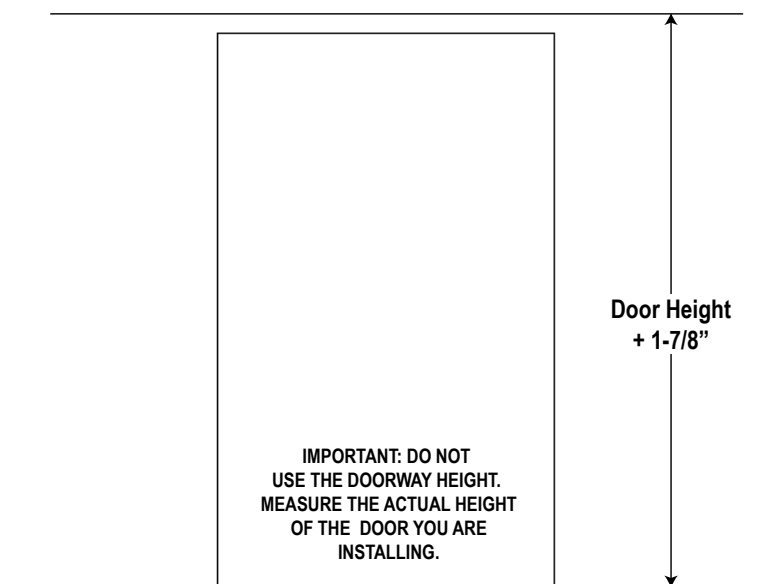

5. Repeat step 4 at several points along the mounting location.

**Note:** If your floor is not level, no further marks are necessary.

6. Using a long level and the marks you made, draw a horizontal line at least as long as the track.

**Important:** This line must be level. Otherwise, the door will roll on its own in one direction or the other after it is mounted.

## Marking the Drill Holes

 <b>CAUTION</b>	<ul style="list-style-type: none"> <li>• Two people are recommended for this stage, especially for longer track lengths. Safety First—Do NOT try to do these steps on your own, particularly if a ladder is required.</li> <li>• Read and follow all the warnings and cautions found at the beginning of this manual.</li> </ul>
---	--





1. Hold up the track so that the horizontal line is centered with the predrilled holes of the track.
2. Make a mark through the center of each hole.

**Note:** These marks should also correspond with the wall studs unless you are using a header board.

3. Set the track aside.

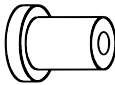
## Mounting the Track

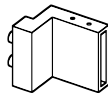
### PARTS

Drawings	Quantity	Description
	1	One complete length of track. This includes individual tracks that are joined by Junction Plates.
	One is needed for each large predrilled hole of the track.	Spacer
	One is needed for each large predrilled hole of the track.	Large Washer (3/4" across)
	One is needed for each large predrilled hole of the track.	Large Lag Bolt (3-3/4" long)
	2	Door Stopper
	One is needed for each large predrilled hole of the track when installing to a concrete wall.	Plastic Anchor (2" long) <b>Note:</b> These are only needed if you are installing to a concrete wall. They are then inserted into the holes you drilled in Step 1 below.

## TOOLS AND EQUIPMENT

- 1/2" (13 mm) Wrench
- Electric Drill
- 11/64" Drill Bit
- Hex (Allen) Wrench (included with the door stopper)
- Safety glasses (and any other appropriate safety gear)

**Note:** If you are installing on a concrete wall, you will need a 3/8" masonry drill bit instead of the 11/64" bit listed above.

 <p><b>WARNING</b></p>	<ul style="list-style-type: none"><li>• Read and follow all the warnings and cautions found at the beginning of this manual. Many are related to the use of power tools and are directly applicable to this section.</li><li>• Always properly install the Door Stoppers on both ends of the track. Door Stoppers are <b>REQUIRED</b> for the safe operation of the door(s). They are designed to help prevent the door(s) from coming off the track.</li></ul>
---	---

## STEPS

1. Using a drill and an 11/64" bit, drill holes where the marks were made.
2. Slide a Door Stopper on each end of the track. The rubber bumpers should be facing inward.
3. Loosely tighten the two screws on each stopper using the included Hex (Allen) Wrench so the Door Stoppers do not slide off. Later in the process you will have to tighten them down firmly.
4. Place a Large Washer on a Large Lag Bolt.

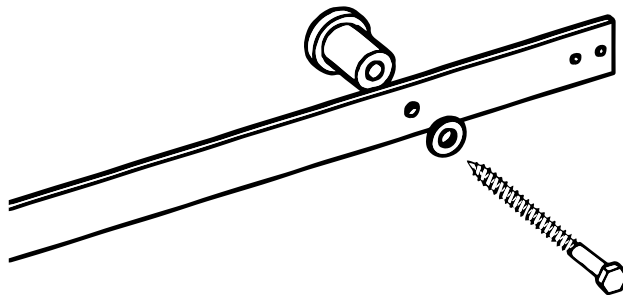

5. Starting at one end of the track, align the Spacer behind the first large predrilled hole of the track. The wider end of the Spacer will be facing the wall.

**Note:** Do NOT try to hold up the entire length of the track in its final position. Allow the other end of the track to hang down, or if it is long enough allow it to rest on the floor.

6. Insert the Large Lag Bolt with the washer through the large predrilled hole of the track and the Spacer, then line it up with the corresponding hole that you drilled.

**Note:** In some cases the Large Lag Bolt may be a very tight fit. If you have problems inserting it, use a 1/2" Wrench to screw the lag bolt in the large predrilled hole of the track.

7. Tighten the Large Lag Bolt using a 1/2" Wrench. Do NOT tighten the bolt all the way rather just tighten it firmly enough to support the weight of the track. The track needs to be able to move and allow for the subsequent Spacers to be inserted behind it for the remaining predrilled holes.
8. At the other end of the track, repeat the steps of placing the washer on the lag bolt, aligning the Spacer behind the predrilled hole of the track, inserting the lag bolt through the track and Spacer, aligning the bolt with the hole you drilled, and tightening the lag bolt.
9. Repeat the steps again for the remaining large predrilled holes.
10. Tighten all the lag bolts firmly.

## Cutting a Channel at the Bottom of the Doors for the Floor Guide (If Needed)

### MATERIALS

Two assembled doors.

### TOOLS AND EQUIPMENT

**Note:** These items are only needed if you have to cut a channel at the bottom of the doors.

- Router
- 1/4" Cutter Bit
- Pencil
- Ruler
- Clamps
- Safety Glasses (and any other appropriate safety gear)

**Note:** If you do not have a router or do not feel comfortable making this cut, other floor guide options are available for purchase.



#### WARNING

Read and follow all the warnings and cautions found at the beginning of this manual. Many are related to the use of power tools and are directly applicable to this section.

### STEPS

1. Check the bottom edge of the door since it may already have a channel. If not proceed to the next step.

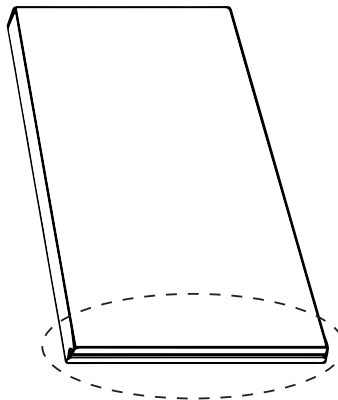

2. Draw a line on the bottom edge of the door. The line should go the full length of the bottom edge of the door, and it must be centered and straight.
3. Clamp down the door to a workbench or otherwise secure the door so it immobilized.
4. Using a router with a 1/4" Cutter Bit and the line as guidance, cut a channel that is 1/4" wide and approximately 5/8" to 13/16" deep at the bottom of the door to accommodate the floor guide. The channel should go the full length of the bottom of the door.
5. Repeat the above steps for the other door.

# Attaching the Hangers to the Inner Door





## MATERIALS

- A 2 x 6 or 2 x 4 piece of wood. (**Note:** A scrap piece of lumber should work fine.)
- Door
- Hangers

## TOOLS AND EQUIPMENT

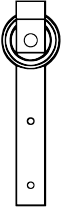
- Pencil
- Ruler
- Speed Square (optional)
- Electric Drill
- Saw
- 27/64" Drill Bit
- 5/8" (16 mm) Wrench
- 11/16" (17 mm) Wrench
- Safety Glasses (and any other appropriate safety gear)

## PARTS

Drawings	Quantity	Description
 (Hanger Styles Vary)	Two are needed per door.	Hanger. There are two hanger styles available.
	One is needed for each predrilled hole of the hanger.	Long Bolt (2-5/8" long)
	One is needed for each predrilled hole of the hanger.	Large Washer (3/4" across)
	One is needed for each predrilled hole of the hanger.	Acorn Nut

 <b>WARNING</b>	<p>Read and follow all the warnings and cautions found at the beginning of this manual. Many are related to the use of power tools and are directly applicable to this section.</p>
---	---

**STEPS**

**Important:** Always check your measurements.

1. Cut a block of wood that measures 1-7/8" in height.

**Note:** Cutting this block from an end of a 2 x 6 or a 2 x 4 piece of wood works well.

**Important:** This block will be used as a measurement spacer for the proper placement of the hangers, so the block's height of 1-7/8" must be as precise as you can make it all the way across the block. A difference of 1/16" is significant and can throw off the installation.

2. Determine the amount of overlap of the doors you want. This is done by taking the distance from the edge of the door and the outer edge of the hanger and multiplying that measurement by 2 then adding 4-1/4" to that amount to determine the total overlap. Adjust the distance used to change the overlap.

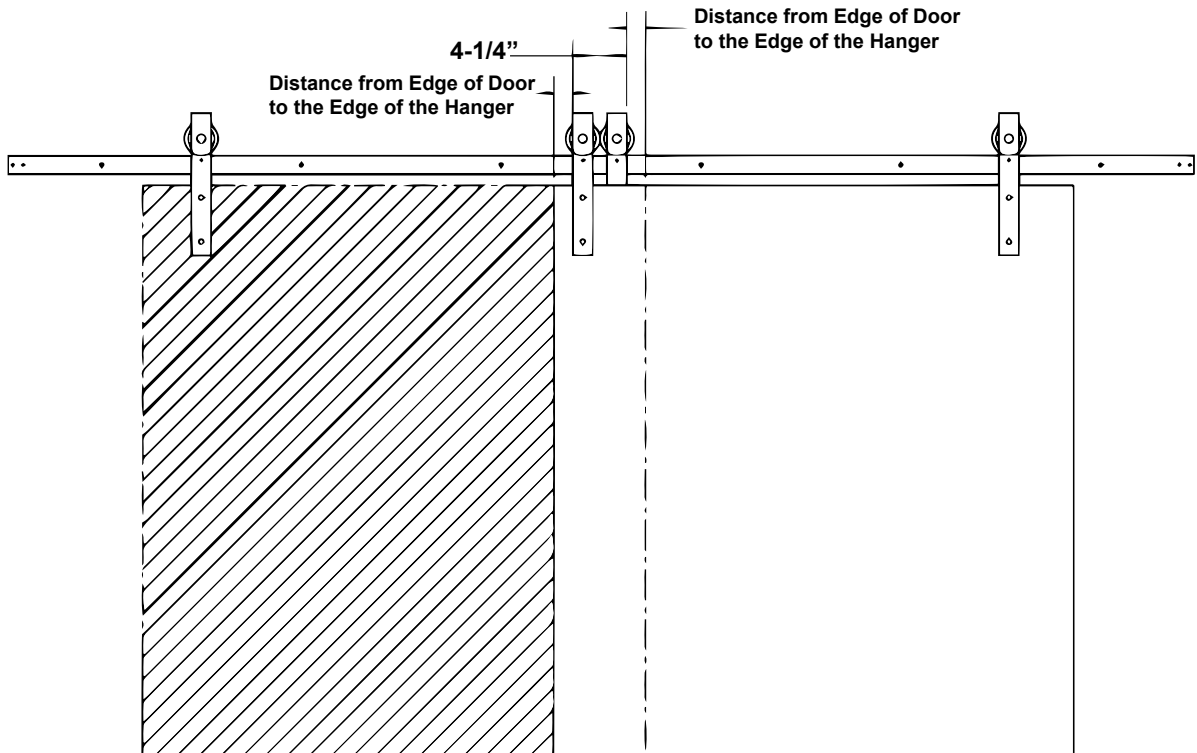

3. Position the hanger on top of the door.

**Note:** The distance from the side edges of the door will vary with the style of your hanger, the style of your door, and the amount of overlap of the doors. Try for a whole number that you can easily measure since it will need to be repeated for the other hangers.

4. Place the block between the top of the door and the roller of the hanger, keeping them firmly against each other. Refer to the image below.

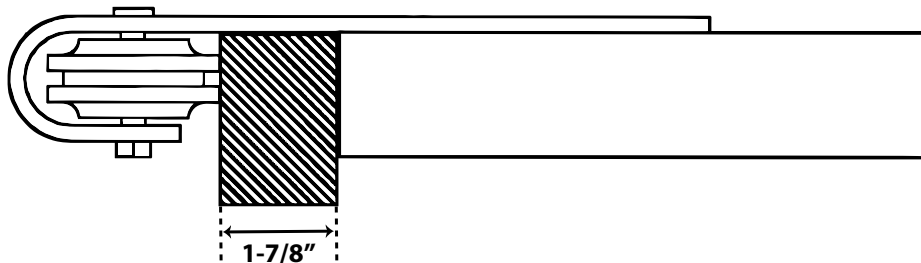

5. Mark the centers of the mounting holes of the hangers.

**Note: A cross hair pattern works well.**

6. Remove the hanger and block.

7. Using a 27/64" bit, drill the holes.

**Note: It is important that you drill the holes accurately. Do NOT rush. You may find that indenting the wood at the center points of the holes before you drill or that drilling a smaller pilot hole may help.**

8. Position a hanger over the set of the drilled holes. The pulley should be facing towards the back of the door.

9. Place a Large Washer on the Long Bolt.

10. Insert the Long Bolt with the washer through the hole on the back of the door and the hole on the hanger.

11. Place a Large Washer and the Acorn Nut on the end of the bolt then finger tighten the nut.

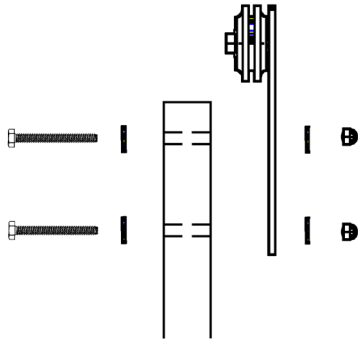

12. Repeat the last three steps for the other hole(s).

13. Using a 5/8" Wrench on the bolts and an 11/16" Wrench on the Acorn Nuts, tighten firmly.

14. Repeat all steps for the other hanger. Use the same measurement for the distance from the side edge of the door for all of the hangers.

## Attaching the Anti-Jump Pads to the Inner Door

### TOOLS AND EQUIPMENT

Phillips Screwdriver

### PARTS

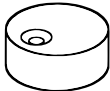
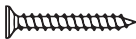
Drawings	Quantity	Description
	Two are needed.	Anti-Jump Pads
	One is needed per Anti-Jump Pad.	Wood Screw (3/4" long)

 <b>WARNING</b>	<p>Always properly install the Anti-Jump Pads to the inner door. Anti-Jump Pads are <b>REQUIRED</b> for the safe operation of the door. They are designed to help prevent the door from jumping off the track.</p>
---	--

**STEPS**

1. Position an Anti-Jump Pad on the top edge of the inner door to the right of the left-side hanger.

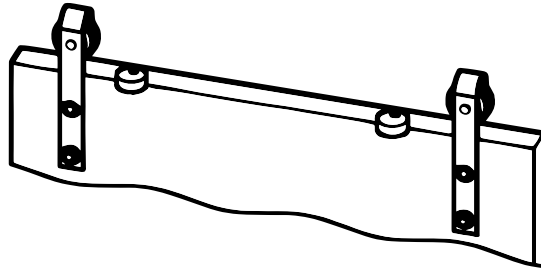

2. Insert the Wood Screw through the hole of the pad and tighten it with a Phillips Screwdriver. It should be loose enough to move with a little effort but not so loose that it is freely moving.
3. Position an Anti-Jump Pad on the top edge of the door to the left of the right-side hanger.
4. Insert the Wood Screw through the hole of the pad and tighten it with a Phillips Screwdriver. It should be loose enough to move with a little effort but not so loose that it is freely moving.
5. Swivel both Anti-Jump Pads so they extend off the front edge of the door.

**Attaching the Outer Door Floor Guide to the Inner Door**





**MATERIALS**

- Inner Door
- Outer Door Floor Guide

**TOOLS AND EQUIPMENT**

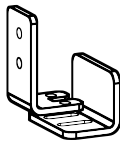
- Pencil
- Phillips Screwdriver
- 5/16" Wrench
- 11/64" Drill Bit (Only if you are using the plastic anchors)
- Electric Drill (Only if you are using the plastic anchors)

**PARTS**

Drawings	Quantity	Description
	One set is needed.	Outer Door Floor Guide
	Two are needed.	Small Screw (1/2" long)
	Two are needed.	Small Nut
	Two are needed.	Screw (1-1/16" long)



Drawings	Quantity	Description
	Two are needed only if you are mounting the Outer Floor Guide to a hollow door.	Plastic Anchors (1-1/8" long)

 <b>WARNING</b>	<p>Read and follow all the warnings and cautions found at the beginning of this manual. Many are related to the use of power tools and are directly applicable to this section.</p>
---	---

## STEPS

**Note:** Refer to the following graphic to know which parts of the Outer Door Floor Guide we are referring to in the steps below.

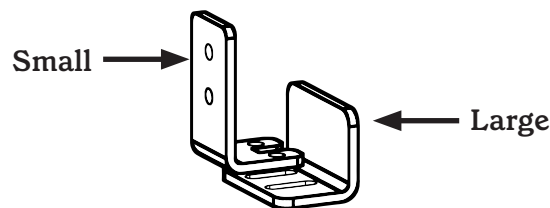

1. On the bottom part of the inner door, locate the portion that will be overlapped by the outer door. Approximately in the middle of the overlap area, hold the small part of the Outer Door Floor Guide so that its shorter leg is under the inner door and against the bottom edge of that door. See the following graphic.

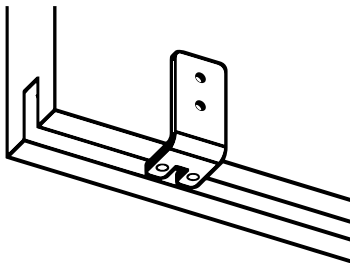

**Note:** This placement is only for marking purposes. This is not the mounting orientation of the part.

2. With your pencil, mark the inner door through the vertical holes of the part.
3. If you are mounting the Outer Door Floor Guide to a hollow door, drill holes at your marks using an 11/64" bit and insert the plastic anchors.
4. Turn the part around so the shorter leg of the part is now pointing away from the door.
5. Align up the part so the marks you made (or the holes of the plastic anchors, if applicable) are visible through the holes of the small part of the Outer Door Floor Guide.
6. Screw in the part with the two screws and a Phillip Screwdriver.
7. Position the large part of the Outer Door Floor Guide under the smaller part.
8. Loosely attach the two parts with the small screws and nuts.

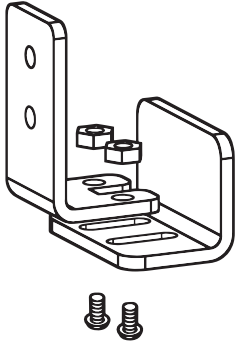

9. There is adjustability to the overall length of the Outer Door Floor Guide. Slide the parts of the guide so it is fully extended.

**Note:** Depending on your particular doors, you may need to adjust this length later.

10. Firmly tighten the small screws and nuts using a Phillips Screwdriver and a 5/16" Wrench.

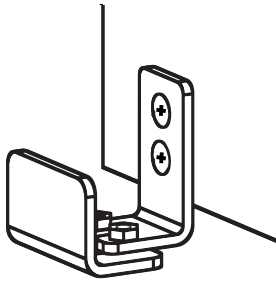

## Mounting the Inner Door on the Track

 <b>WARNING</b>	<ul style="list-style-type: none"> <li>• Two people are recommended for this stage, especially if your door(s) is heavy.</li> <li>• Remember to use proper lifting techniques, bending your knees and lifting with your legs.</li> <li>• The Anti-Jump Pads must be properly positioned.</li> <li>• The Door Stoppers must be secured so they do not move.</li> <li>• Read and follow all the warnings and cautions found at the beginning of this manual.</li> </ul>
---	---

### TOOLS AND EQUIPMENT

- Hex (Allen) Wrench (included with the door stopper)
- Phillips Screwdriver

### STEPS

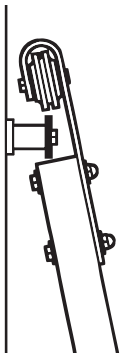

1. Position the door(s) near the track.
2. Lift the door and angle it in so that the pulleys are over the track.
3. Lower the door so that the grooves of the pulleys are resting on the track.
4. Swivel the Anti-Jump Pads 180 degrees so they are positioned under the track.
5. Tighten the screws firmly with a Phillips Screwdriver. (Required)

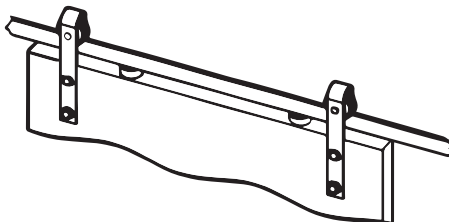

6. Slide the Door Stoppers to the desired position.
7. Firmly tighten the screws of the Door Stoppers with the Hex (Allen) Wrench. (Required)

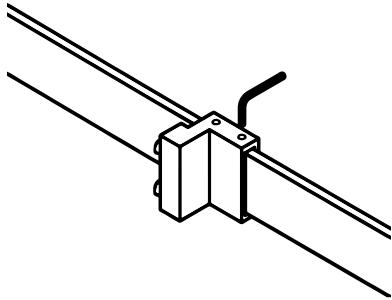



8. Check to see if the Anti-Jump Pads are functioning correctly by lifting up on the door. You should not be able to completely lift it off the track since the Anti-Jump Pads should be close enough to the bottom of the track to prevent it. If there is too much space between the Anti-Jump Pads and the track, shim the Anti-Jump Pads with a washer. The mounting screws of the Anti-Jump Pads should go through the center of the washers. And, the washers should be an adequate size to fully support the Anti-Jump Pads and prevent the door from being completely lifted off the track while still allowing the pads to slide under the track without touching it (or the optional soft-close mounting points when in use).

## Installing the Floor Guide for the Inner Door

### TOOLS AND EQUIPMENT

- Long Level
- Pencil
- Electric Drill
- 7/32" Drill Bit
- Phillips Screwdriver
- Safety Glasses (and any other appropriate safety gear)

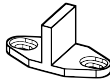
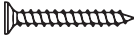
### PARTS

Drawings	Quantity	Description
	One is needed per door.	Floor Guides
	Two are needed per Floor Guide.	Screw (1" long)
	Two are needed per Floor Guide.	Plastic Anchors (1-3/16" long)

 <b>WARNING</b>	<p>Read and follow all the warnings and cautions found at the beginning of this manual. Many are related to the use of power tools and are directly applicable to this section.</p>
---	---

**STEPS**

1. Slide the door all the way to the side so it is in the open position.
2. Position a Floor Guide so that half the width of the vertical edge of the Floor Guide is inside the bottom channel of the door.

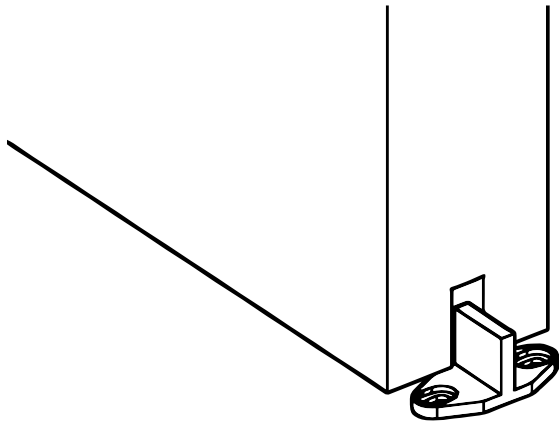

3. Using your level on the front or back sides of the door, ensure the door is plumb (hanging straight vertically) and hold it still when plumb.

**Note:** It might be helpful for a second person to hold it plumb while you complete the steps.

4. Adjust the Floor Guide so it is centered in the channel.
5. Mark the center of the holes of the Floor Guide and remove.
6. Repeat the above steps for the other door and Floor Guide.
7. Using a drill and a 7/32" bit, drill holes where you placed the marks.
8. Insert the Plastic Anchors into the holes.
9. Position the Floor Guides over the holes.
10. Insert the screws and tighten with a Phillips Screwdriver.

## Attaching the Hangers to the Outer Door







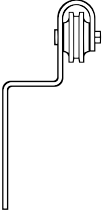

**MATERIALS**

- Door
- Hangers

**TOOLS AND EQUIPMENT**

- Pencil
- Ruler
- Speed Square (optional)
- Electric Drill
- 27/64" Drill Bit
- 5/8" (16 mm) Wrench
- 11/16" (17 mm) Wrench
- Safety Glasses (and any other appropriate safety gear)

## PARTS

Drawings	Quantity	Description
 (Hanger Styles Vary)	Two are needed per door.	Hanger. There are two hanger styles available.
	One is needed for each predrilled hole of the hanger.	Long Bolt (2-5/8" long)
	One is needed for each predrilled hole of the hanger.	Large Washer (3/4" across)
	One is needed for each predrilled hole of the hanger.	Acorn Nut
	Two are needed per door.	Anti-Jump Bracket
	Two are needed per door.	Small Washer (1/2" across)
	Two are needed per door.	Small Screw (3/4" long)
	Two are needed per door.	Small Nut

 <b>WARNING</b>	<p>Read and follow all the warnings and cautions found at the beginning of this manual. Many are related to the use of power tools and are directly applicable to this section.</p>
---	---

## STEPS

**Important:** Always check your measurements.

1. Position the hanger on top of the door. For symmetry, use the same distance from the edge of the door as you did for the inner door.

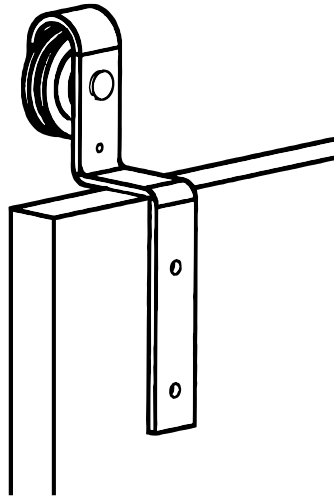

2. Add a gap of 1/4" between the horizontal bend and the top of the door. Use the other hanger as a spacer while marking the holes since it is 1/4" thick. Refer to the graphic below.

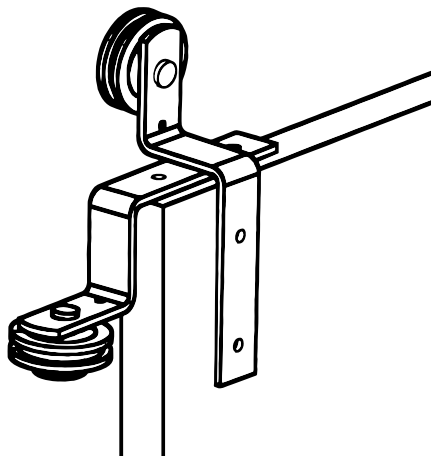

3. Mark the centers of the mounting holes of the hangers.

**Note:** A cross hair pattern works well.

4. Remove the hangers.
5. Using a 27/64" bit, drill the holes.

**Note:** It is important that you drill the holes accurately. Do NOT rush. You may find that indenting the wood at the center points of the holes before you drill or that drilling a smaller pilot hole may help.

6. Position a hanger over the set of the drilled holes. The pulley should be facing towards the back of the door.
7. Place a Large Washer on the Long Bolt.
8. Insert the Long Bolt with the washer through the hole on the back of the door and the hole on the hanger.
9. Place a Large Washer and the Acorn Nut on the end of the bolt then finger tighten the nut.

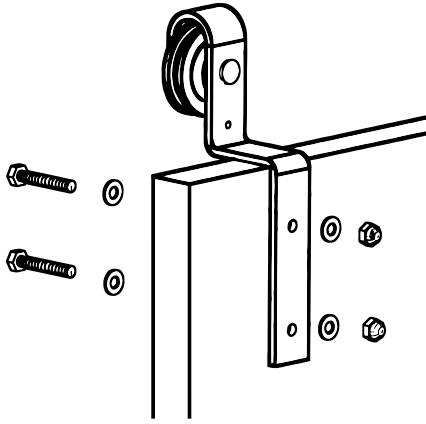

10. Repeat the last three steps for the other hole(s).
11. Using a 5/8" Wrench on the bolts and an 11/16" Wrench on the Acorn Nuts, tighten firmly.
12. Attach the Anti-Jump Bracket to the hanger by placing the small washer on the screw, inserting the screw through the small hole on the hanger and the bracket, and screwing on the nut. Leave the bracket very loosely tightened so the outer door can be mounted on the track. You will tighten them firmly later in the process. Refer to the graphic below for the order of assembly of the Anti-Jump Bracket parts.

**Note:** The washer placement is important since it acts as a spacer. If the washer is not in the proper position, the screw will hit the lag bolt heads on the track.

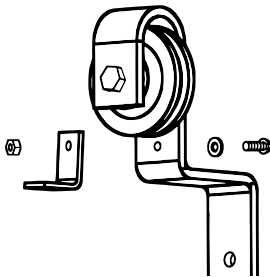

13. Repeat all steps for the other hanger. Use the same measurement for the distance from the side edge of the door for both hangers.

## Mounting the Outer Door on the Track



### WARNING

- Two people are recommended for this stage, especially if your door(s) is heavy.
- Remember to use proper lifting techniques, bending your knees and lifting with your legs.
- The Anti-Jump Brackets must be properly positioned.
- Read and follow all the warnings and cautions found at the beginning of this manual.

### MATERIALS

- Outer Door
- Inner Door (already mounted on the track with Outer Door Floor Guide attached)

### TOOLS AND EQUIPMENT

- 4 mm Hex (Allen) Wrench (included with the Anti-Jump Bracket)
- 10 mm Combination Wrench

### STEPS

1. Position the door near the track.
2. Lift the door and lower it down so that the Outer Door Floor Guide goes into the channel at the bottom of the door.

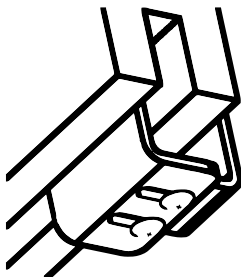

3. Lift up and move the door so that the grooves of the pulleys are resting on the track. Remember to overlap the doors.
4. Firmly tighten the screws of the Anti-Jump Brackets to the hangers with the Hex (Allen) Wrench and a 10 mm Combination Wrench. (Required)
5. Check to see if the Anti-Jump Brackets are functioning correctly by lifting up on the door. You should not be able to lift the door completely off the track.





**©2022 RUSTIC ROLLING DOORS  
394609 CONCESSION 2  
DURHAM, ON, NOG 1R0  
(800) 997-5085  
WWW.RUSTICROLLINGDOORS.COM**