



**DUSTY'S**  
RUSTIC ROLLING DOORS

**Mini Single-Track Bypass Barn Door  
Hardware Kit  
Installation Manual**

# SAFETY PRECAUTIONS

## ⚠ WARNING!

- Power tools can cause serious damage if not professionally used. Safety gear must be worn before installation to prevent unexpected injuries.
- Pick an area free of hazardous condition before you start on the project. Please use tools and power tools responsibly any loss of control and accident deaths may occur due to abuse of tools.
- Please make sure all hardware is secured on to the door is sufficiently tight. Doors with loose hardware may result in unexpected serious injuries. To avoid any problems do be sure hardware is secure before door is put on the track.
- All hardware provided is for safety reasons. Anti-Jump systems are to prevent doors from falling off the track while in use. Please follow each instruction carefully. Track must be installed on studs in order to keep the track and doors secure from serious problems. All safety hardware and instructions included in this project must be used and followed specifically to prevent any unforeseen serious problems.

## !CAUTION!

- Big objects required in this project are needed to be carefully and responsibly moved. Be sure to wear safety gloves and shoes to prevent any serious injury.
- Be extremely careful to not put any parts of your body against a moving part of the hardware. This may cause bruising, punctures, and other results of injuries when for example when fingers are caught in the closing area of the doors.
- Precautions should be taken when opening or closing the door(s). Handles should be used when attempting to slide the door(s). Always keep you and children aware and safe from any unexpected situations.
- Any extreme uncontrolled pressure opening or closing the door(s) can damage the hardware gradually. Use handle(s) to open and close the door(s) with care at all times.

# HARDWARE INCLUDED

**Different track length comes with different hardware quantity.  
Please be sure to check the hardware you should have before installation.**

Hanger/Roller Box contains:

Mini Steel Hanger/Roller (2)

Hanger/Roller Screw (4),

Anti-Jump Pad (2), Floor Guide (1)

Door Stopper (2), Hex Wrench (1)

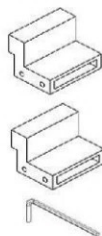
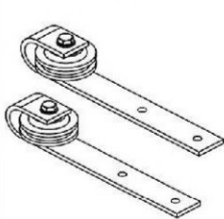

Bent Hanger/Roller Box contains:

Mini Steel Hanger/Roller (2)

Hanger/Roller Screw (4),

Adjustable Floor Guide (1)

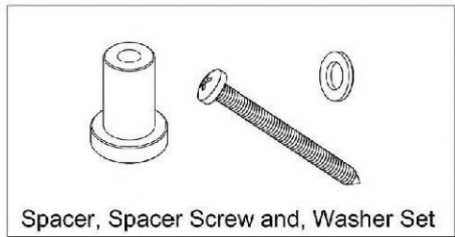
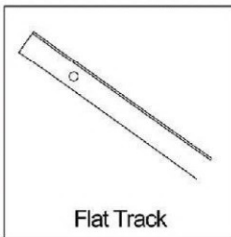
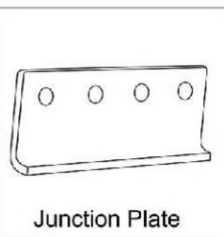
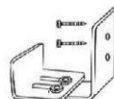
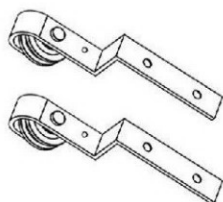

## HARDWARE CHECKLIST

Track Measurement	Hanger/Roller Box	Bent Hanger/Roller Box	Flat Track	Spacer and, Spacer Screw	Junction Plate
24in.	1	1	1	2	0
30in.	1	1	1	2	0
36in.	1	1	1	3	0
42in.	1	1	1	3	0
48in.	1	1	1	3	0
54in.	1	1	2	4	1
60in.	1	1	1	4	0
66in.	1	1	2	5	1
72in.	1	1	2	6	1
78in.	1	1	2	6	1
84in.	1	1	2	6	1
90in.	1	1	2	6	1
96in.	1	1	2	7	1
102in.	1	1	2	7	1
108in.	1	1	3	8	2
114in.	1	1	2	8	1

# TRACK LENGTH DETAIL

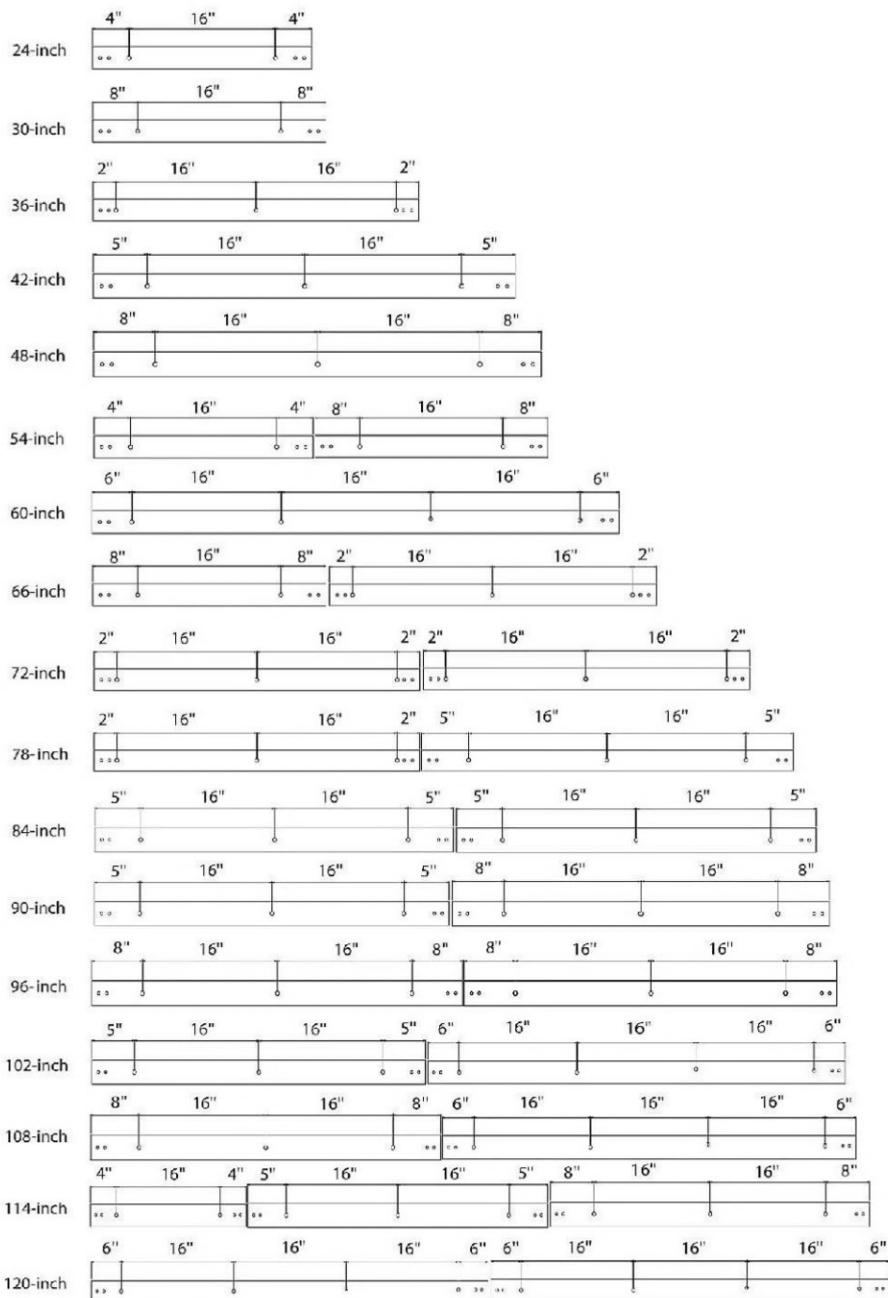

# INSTRUCTIONS

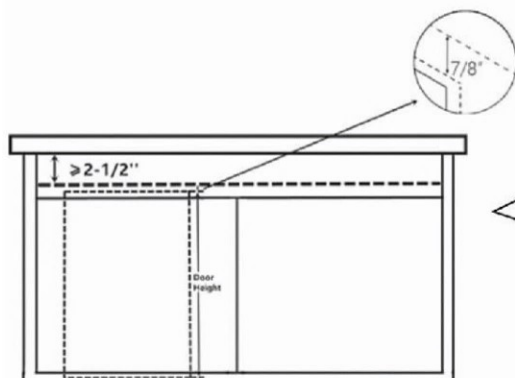

Step - 1

Draw a horizontal line using the following formula ( $1/2'' + \text{Door height} + 7/8''$ ). This line will be used as the center line of the track. Make sure to leave out at least  $2-1/2''$  clearance for the top of the roller.

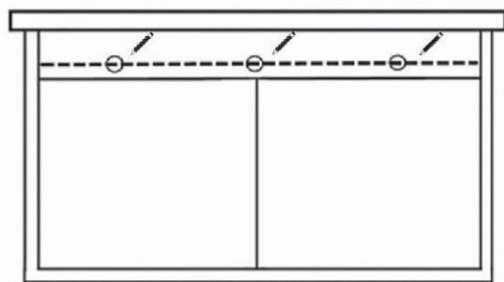

Step - 2

Attach the track on to the line you drew in the step 1 and mark down the positions for all the holes.

If your track comes in 2pos or more, install the junction plate on to each two tracks like the diagram shown here.

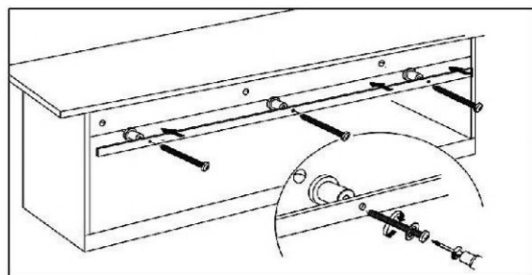
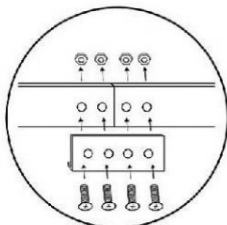

Step - 3

Drill previously marked holes and install the spacer screws and spacers onto the holes as shown in the picture.



Step - 4

Open a slot that is  $1/4''$  wide and  $13/16''$  deep at the bottom of the door with a router. This groove will be used with the floor guide.

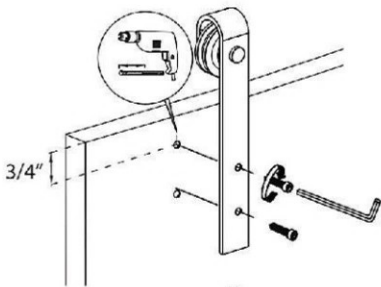

Step-5

Drill the holes for the roller according to the dimension given in the picture with the straight hanger/roller with the hanger screws provided. Attach the roller to the door using hex wrench as shown in the picture.

**Here is the formula to calculate the overlap space:**

The overlap = 2 \* Distance from the left (right) edge of the door to the left (right) edge of the hanger + 2 5/8"

For example, if you install each hanger 1" from the edge of the door, the overlap + 2 \* 1" + 2 5/8" = 4 5/8"

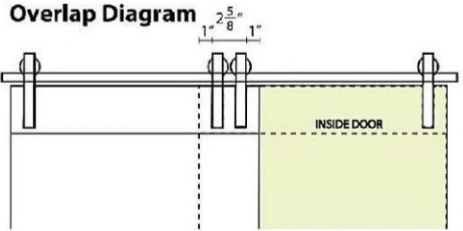

Step-6

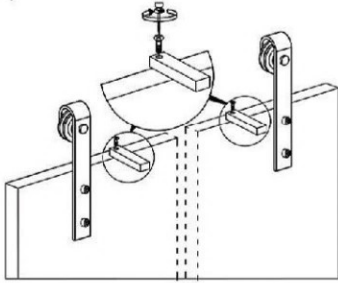

Install the anti-jump pads as shown in the picture. Then tilt it until it lines up with the door.

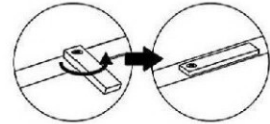

Step-7

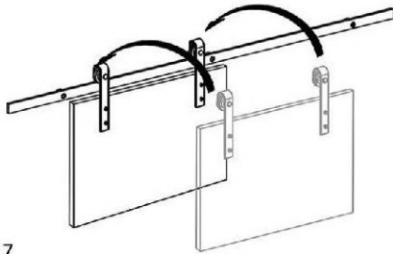

Lift your door at a slight angle and rest both wheel grooves onto the top of the track carefully.

Step-8

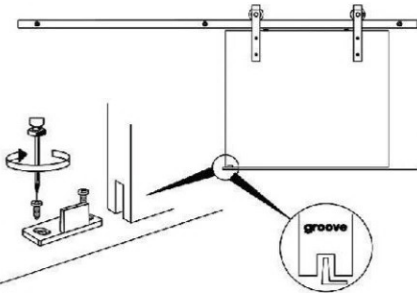

Install the regular floor guide in your own location preference depending on how you want your inside door to slide. After the door is hung on to the track you will be able to locate where you want the floor guide to be installed according to your decision of sliding.

Step-9

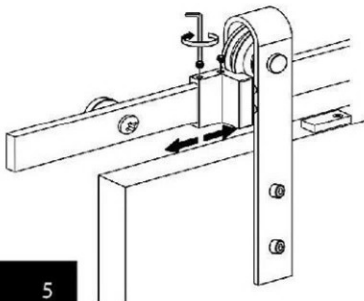

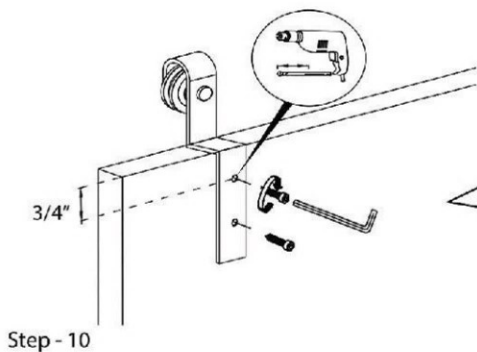

Install the door stopper on the track placing it where you want it to be. The position is adjustable using the hex wrench



Repeat the same step for the bending hanger design. Just like step 5.

Step - 10

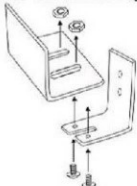
## INSTALLATION OF THE ADJUSTABLE FLOOR GUIDE FOR BENT HANGERS

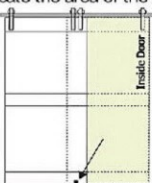
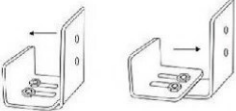
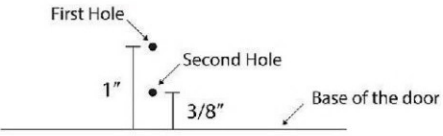
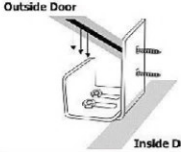
<p><b>1</b> Put the hardware together.</p>  <p>Fasten the screws loosely but just enough to hold them together.</p>	<p><b>4</b> Install the bypass floor guide on to the area marked.</p>  <p>Install the floor guide on to the inside door on the indicated area of the first and second hole.</p>
<p><b>2</b> Locate the area of the door to install the bypass floor guide.</p>  <p>Locate the area where the two doors overlap when its fully closed. Have the floor guide to be installed on the inside door. (Inside door is tinted on the diagram.)</p>	<p><b>5</b> Adjust the bypass floor guide.</p> <p>Adjustable to fit any door thickness.</p>  <p>Now fasten the screws tightly so the adjustment does not move out of place.</p>
<p><b>3</b> Mark the dotted guides on the location of the inside door.</p>  <p>First Hole Second Hole 1" 3/8" Base of the door</p>	<p><b>6</b> Have the outside door set on the track.</p>  <p>You can now put the outside door on the track and fit the tip in to the doors groove while following step 12.</p> <p>Outside Door Inside Door</p>

Step - 11

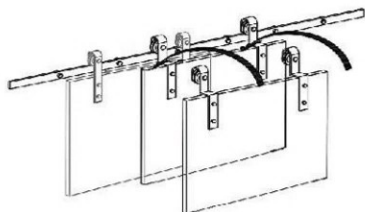

Repeat the same step for the doors with bending design hanger as Step 7. You can use this method to slip the groove of the door into the tip of the floor guide.

Step - 12

**YOUR INSTALLATION IS COMPLETE!**