

W Series Shelf

Installation Instructions for WS-SH-2, WS-SH-3



Parts List

- (1) W Series Shelf
- (1) Non-slip silicon mat
- (2) Self-drilling screws
- (4) Toggle bolts
- (4) Wood screws
- (4) Mounting hole covers

Required Tools

- Phillips head screwdriver
- Level
- Pencil
- Drill
- 1/2 inch (12.7mm) & 3/32 inch (2.4mm) drill bits
- Clamp (to align multiple shelves)
- Tape measure

Fasteners We recommend the following fasteners for these surfaces:

- Drywall: Use included toggle bolts
- Wood/stud (must be 1/2 inch (19mm) thick): Use included wood screws
- Concrete, Brick or Stucco: 3/16" x 1 1/4" masonry screw or #8 x 1 1/4" screw with appropriate size expanding concrete anchor
- VintageView W Frames (FCF-xx): Each Frame comes with self-drilling screws to attach Shelf

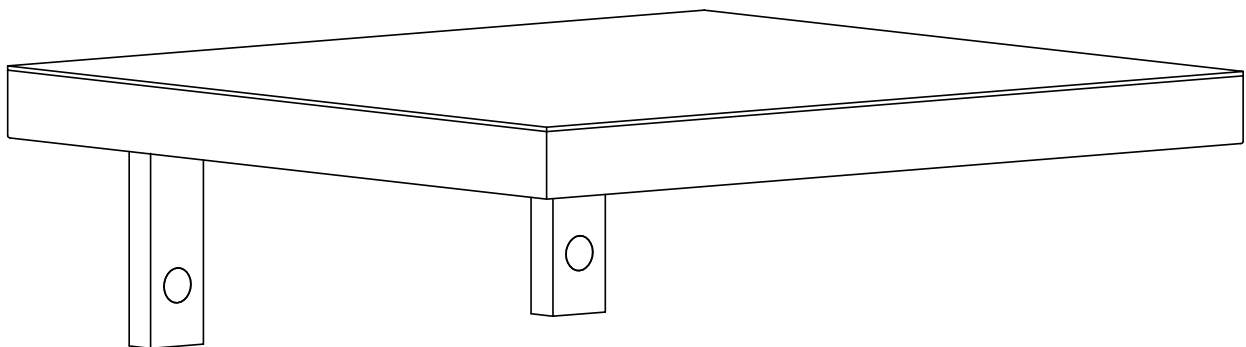

IMPORTANT NOTES:

- Leave enough clearance above the Shelf for whatever you are storing (a magnum bottle stands 15" tall!!!)
- Each shelf is designed to safely support 25 pounds of weight into drywall or at least 50 pounds into solid wood or steel frame applications.
- When aligning Shelves next to one another, fasten the together with the provided self-drilling screws prior to installing for ease of access. Using a clamp helps keep the shelves aligned during the drilling process.



Figure A

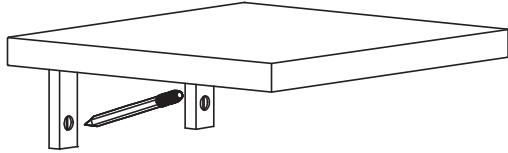

1. MARK MOUNTING HOLES

Position the shelf on the wall where it is to be installed. Make sure there is adequate space above the shelf to store your items (Hint: a magnum wine bottle is usually 15" tall standing upright). Use a level to ensure the shelf is perfectly horizontal. Mark all four (4) mounting hole locations with a pencil (Figure A), and set the Shelf aside.

Figure B

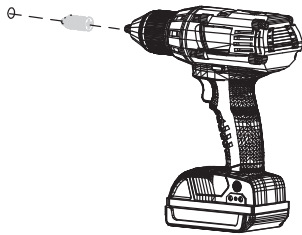

2. PREP SURFACE FOR ANCHORS

Using the 3/32" bit, drill a pilot hole in the center of the marked hole locations. If a marked hole location is over a stud or the surface is wood (1/2" thick or greater) drill the pilot hole only and skip to step 3B. For drywall, use the 1/2" bit to enlarge the pilot hole for the toggle bolt (Figure B).

3. HANG THE SHELF for Drywall

Remove the expanding nuts from the toggle bolts and insert the bolts through the mounting holes. Thread the expanding nuts back onto the bolts until the tip of the bolt is slightly protruding from the nut with the wings positioned so they will fold toward the head of the bolt (Figure C). Align the folded wings of the expanding nuts with the holes in the wall and gently push them through the wall, ensuring that both wings of the nut expand on the back side of the wall. When all toggle bolts are in place, gently tighten them using a screwdriver. Check that the shelf is level and fully tighten the toggle bolts.

Figure C

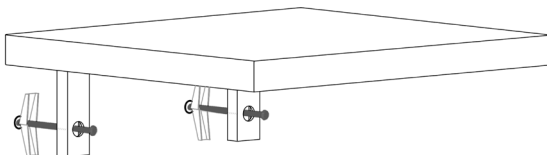

for Wood

Fasten the shelf through the mounting holes using the provided wood screws. (Figure D)

4. INSERT MOUNTING HOLE CAPS

With the shelf fastened to the wall, simply press the provided mounting hole caps into the 1/2 inch holes in the face of the shelf to cover the mounting hardware.

Figure D

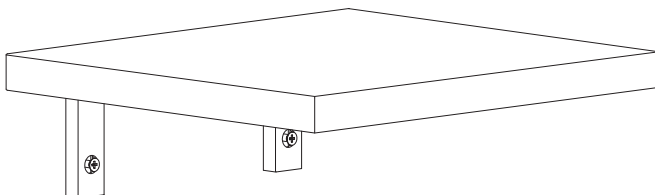
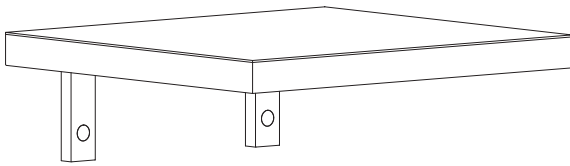



Figure E



5. PLACE THE MAT

Remove the protective film from the non-slip mat and rest it on the surface of the shelf (Figure E). This food grade silicon mat will help keep your items in place.

6. ADD WINE

Only the good stuff — or anything else that looks really good on a shelf.

Figure F

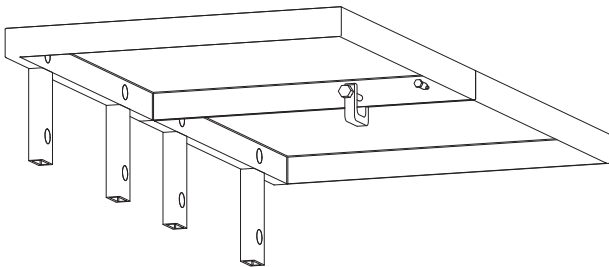

Lining Shelves Up

When plans call for installing multiple Shelves next to one another at standard 13" spacing (touching), we recommend fastening the shelves together with the provided self-drilling screws prior to installing for ease of access.

Using a clamp helps keep the shelves aligned during the drilling process (Figure F).

Maintenance and Care:

Like every VintageView product, the W Series Shelf is backed by a lifetime warranty. They should be regularly checked for tightness. Should any piece to be found to be loose, tighten until secure. If the face of the wall surface shows signs of breakage, discontinue use immediately until the wall may be adequately repaired. W Series products may be cleaned with a damp cloth and mild dish soap — abrasive pads or steel wool should NOT be used as they will damage the finished surfaces of the parts.

Need more help? Visit VintageView.com

