



Ducted Split
Wine Cellar Cooling Systems
Installation, Operation and Maintenance Manual
60Hz Models: DS025, DS050, DS088, DS200
50Hz Models: WGS40, WGS75, WGS100, WGS175



Manufactured by



AIR INNOVATIONS

Syracuse, NY

wineguardian.com

airinnovations.com

Wine Guardian reserves the right, without notice, to make changes to this document at its sole discretion.

Please visit our web site for the most current version of the Wine Guardian manual and other literature.

Wine Guardian is a registered trademark (2,972,262) of Air Innovations, Inc.

Edition 12/2021 (Original Instructions)

© Air Innovations 2021

Part No. 15H0326-00

Table of Contents

Safety	5
Lockout/Tagout Procedure	6
Safety Warnings	6
Receiving, Inspecting and Unpacking	6
Directory of terms	7
General Overview	8
Accessories/Options	10
Component Overview	12
Overview of the Evaporator	13
Overview of the Condenser	15
Refrigeration Illustration	16
Wiring Diagram for DS025, DS050, WGS40, WGS75, WGS100 Evap	17
Wiring Diagram for DS025, DS050, WGS40, WGS75, WGS100 Cond	18
Wiring Diagram for DS025, DS050, WGS40, WGS75, WGS100 Control Board	19
Wiring Diagram for DS088, WGS100 Evap	20
Wiring Diagram for DS088, WGS100 Cond	21
Wiring Diagram for DS200, WGS175 Evap	22
Wiring Diagram for DS200, WGS175 Cond	23
Specifications	24
Installation	26
Pre-Installation	26
Pre-Installation Planning	26
Installing The Fan-Coil	26
Reducing Noise Generation	27
Ductwork	27
Duct Collar and Panel Adjustment	29
Drain Line	30
Wiring the Fan-Coil	30
Installing The Condensing Unit	32
Installation of Interconnecting Refrigerant Lines	32
Refrigerant Line-Sets	33
Sample line Set Configurations	34

Leak Checking and Evacuation Process	34
Wiring the Condenser	35
Installing the Remote Interface and Communication Cable	37
Additional Remote Interface	38
Controller Specification	38
Mounting the Remote Interface Controller (Wired)	39
Mounting the Remote Interface Controller (Wireless)	40
Installation of the Wine Guardian Remote Sensor	41
Mounting the Remote Sensor (Wired)	41
Mounting the Remote Sensor (Wireless)	43
Remote Sensor Pairing – Multiple Sensors (Wireless)	44
Remote Interface Functions	45
Alarm Codes	52
Start-Up	54
Refrigerant Charging	54
Charging System with Head Pressure Control	54
Charge Amount:	56
Split System Operations Chart	58
Final Start-up	59
Maintenance	63
Cleaning the Humidifier (Optional)	64
All Wine Temperatures (AWT)	64
Extreme Climate Protection	64
Maintenance Schedule	64
Monthly	64
Yearly	65
Troubleshooting	66
Resetting the High-Pressure Switch	66
Contact and Warranty	68
Contact Information	69
Warranty	69

Note: This equipment has been tested and found to comply with the limits for a Class B digital device, pursuant to part 15 of the FCC Rules. These limits are designed to provide reasonable protection against harmful interference in a residential installation. This equipment generates, uses and can radiate radio frequency energy and, if not installed and used in accordance with the instructions, may cause harmful interference to radio communications. However, there is no guarantee that interference will not occur in a particular installation. If this equipment does cause harmful interference to radio or television reception, which can be determined by turning the equipment off and on, the user is encouraged to try to correct the interference by one or more of the following measures:

- Reorient or relocate the receiving antenna.
- Increase the separation between the equipment and receiver.
- Connect the equipment into an outlet on a circuit different from that to which the receiver is connected.
- Consult the dealer or an experienced radio/TV technician for help. RSS GEN (English)

This device contains license-exempt transmitter(s)/receiver(s) that comply with Innovation, Science and Economic Development Canada's license-exempt

RSS(s). Operation is subject to the following two conditions:

1. This device may not cause interference.
2. This device must accept any interference, including interference that may cause undesired operation of the device.

RSS GEN (French)

L'émetteur/récepteur exempt de licence contenu dans le présent appareil est conforme aux CNR d'Innovation, Sciences et Développement économique Canada applicables aux appareils radio exempts de licence. L'exploitation est autorisée aux deux conditions suivantes:

1. L'appareil ne doit pas produire de brouillage;
2. L'appareil doit accepter tout brouillage radioélectrique subi, même si le brouillage est susceptible d'en compromettre le fonctionnement.

Safety

The safety messages contained in this manual are bold and highlighted in red for quick identification. A Danger message indicates an imminently hazardous situation which, if not avoided, can result in death or serious injury. Messages identified by the word DANGER are used sparingly and only for those situations presenting the most serious hazards. The following is a typical example of a Danger message as it could appear in the manual.



HIGH VOLTAGE - RISK OF SERIOUS INJURY OR DEATH

High voltages are present in the cabinets.

Before opening panels turn off all power.

Use the Lockout/Tagout procedure.

The equipment covered by this manual is designed for safe and reliable operation when installed and operated within its designed specifications. To avoid personal injury or damage to equipment or property when installing or operating this equipment, it is essential that qualified, experienced personnel perform these functions, using good judgment and safe practices. See the following cautionary statements. Installation and maintenance of this equipment is to be performed only by qualified personnel who are familiar with local codes and regulations and are experienced with this type of equipment.

Exposure to safety hazards is limited to maintenance personnel working in and around the unit. When performing maintenance, always use the Lockout/Tagout procedure, which is described in this chapter. Observe the maintenance safety guidelines in the Wine Guardian Manual.

Electrical Hazards - Working on the equipment may involve exposure to dangerously high voltage. Make sure you are aware of the level of electrical hazard when working on the system. Observe all electrical warning labels on the unit. There are no electrical safety lockouts installed within the unit. The power cord attached to the control box must be disconnected from the power sources prior to working on any part of the electrical system.

Hot Parts Hazards Electric - Electric heaters may start automatically, disconnect all power and control circuits prior to servicing the unit to avoid burns.

Moving Parts Hazards - The motor can start automatically. Disconnect all power and control circuits prior to servicing to avoid serious injuries or possible dismemberment. Be sure to use the Lockout/Tagout procedure when working on these units.

Lockout/Tagout Procedure

1. Turn off the power switch (indicator light should be off).
2. Unplug the unit from the electrical outlet and cover the outlet to prevent accidentally plugging in the unit.

Safety Warnings

- Never reach into a unit while the fan is running.
- Disconnect all power sources before working on the unit.
- Check weights to be sure the rigging equipment can support and move the Wine Guardian unit safely. **Note:** any specific rigging and installation instructions located in the [Installation section](#) of the Wine Guardian Manual.
- Do not remove access panels until fan impellers have completely stopped. Pressure developed by moving impellers can cause excessive force against the access panels.
- Never pressurize equipment above specified test pressure (~300 psi).
- Always ground the outlet to provide adequate protection against voltage surges and built-up static charges.
- Refer all servicing to qualified service personnel. Servicing is required when the unit has been damaged in any way.
- Do not use extension cords.
- Do not modify the equipment; it may cause damage to the equipment and will void the warranty.

Receiving, Inspecting and Unpacking

When receiving the unit, ensure the unit is undamaged and includes all ordered accessories.

Note: Wine Guardian units are factory assembled and tested prior to shipment. Wine Guardian units are shipped in individual corrugated boxes.

- ✓ Lift only at the designated handhold locations or fully support from underneath. A shipment may include one or more boxes containing accessories.
- ✓ Before opening the container, inspect the packing crates or boxes for obvious signs of damage or mishandling.
- ✓ Write any discrepancy or visual damage on the bill of lading before signing.
- ✓ Inspect all equipment for any signs of damage caused during transit.
- ✓ Report all visual or concealed damage to the carrier and file a claim immediately.
- ✓ Thoroughly inspect the contents for any visible damage or loose parts.

IMPORTANT

If this procedure is not followed, the shipping company may reject the claim and the consignee may suffer the loss. Do not return the shipment to the factory.

Review the Packing Slip to verify:

- ✓ Model #
- ✓ Factory Installed Options
- ✓ Unit Accessories

If any items listed on the packing slip do not match your order information, contact the place of purchase immediately.

Check the unit for the following:

- ✓ An Electrical Power Cord connected to unit
- ✓ A Remote Interface with 50' of Communications Cable
- ✓ 7' of Clear Plastic Drain Hose
- ✓ Quick Start Guide
- ✓ Remote Interface Operation Guide
- ✓ Remote Interface Mounting Template

Directory of terms

- **Ambient Air** – The surrounding air outside the cellar such as a room, basement, garage or outdoors.
- **CFM** – Cubic feet per minute. A unit of measurement for the amount of air handled by the fan.
- **Condensate / Condensation** – The water formed out of the air when it is cooled below a certain temperature (called dew point). Often referred to as “sweating” on pipes and cold surfaces. This water collects at the bottom of the evaporator or cooling coil and drains out of the unit through the drain line.
- **Condenser (Heat Rejection) Section / Coil** – The Condenser Section uses the compressor, condenser coil and fan to remove heat from the refrigerant to the ambient air outside the wine cellar. The word condenser refers to the condensation of the refrigerant from gas to liquid phase.
- **CE** – Certificate of European conformity.
- **CSA/ETL** – Canadian Standard Association/Electric Testing Laboratory.
- **Exhaust Air** – The air leaving the evaporator or condenser section of the Wine Guardian unit.
- **Evaporator (Cooling) Section / Coil** – The Evaporator Section uses the cooling coil and the fan to remove heat from the air inside the wine cellar to the refrigerant, cooling the air and condensing moisture out of the air. The word evaporator refers to the evaporation of the refrigerant from liquid to gas phase in the coil. The Evaporator Section is connected to or inside the wine cellar.
- **Flexible Duct** – Round ducts with steel reinforced plastic liners, a layer of insulation and an outer plastic layer used to convey the air from the unit to the cellar or ambient space.
- **Grille or Diffuser** – Inlet or outlet plates to direct the airflow or protect the inside of the unit.

- **Heat Gain / Loss** – The amount of cooling or heating expressed in watts transferred between the wine cellar and the ambient space. The Wine Guardian must offset this load.
- **Inlet Air** – The air entering the evaporator and condenser sections of the Wine Guardian unit.
- **I.D.** – Inside diameter.
- **O.D.** – Outside diameter.
- **NEC** – National Electrical Code.
- **Psig Pounds** – Force per square inch gauge.
- **Recovery** – The amount of cooling the unit does to return the cellar to its set point temperature after some new load is introduced, such as people or new cases of warm wine entering the cellar.
- **Return Air** - The air leaving the cellar and returning to the inlet of the evaporator coil.
- **SP** – Static pressure. Unit of measurement (inches of water column) of the pressure of the air handled by the fan.
- **Set Point** – The desired temperature or humidity set on the thermostat or humidistat.
- **Supply Air** - The air entering the cellar from the discharge of the evaporator coil.

General Overview

The Wine Guardian cooling unit is a professional grade, American-manufactured, split two-piece climate control system designed specifically for the storage of wine at cellar temperatures. It is designed for easy installation and operation. Wine Guardian uses digital electronic controls and R-134a refrigerant. The entire Wine Guardian fan coil section and the condensing unit is tested at the factory. All components are of a high-quality, standard commercial grade.

The entire system is approved by ETL according to UL 1995 and CSA safety standards. All wiring complies with NEC. Each Wine Guardian fan coil section is furnished with a sealed, UL-approved power cord and plug.

All Wine Guardian 50Hz units carry the CE mark. Each unit is furnished with a sealed, CE-approved power cord.

Each Ducted Split Wine Guardian Fan Coil Contains the following

- ✓ A thermal expansion valve to control the flow of refrigerant into the evaporator coil.
- ✓ A built-in condensate drain trap. **(Do not install an external trap)**
- ✓ A removable control panel for ease of service.
- ✓ Supply duct collar.
- ✓ Return duct collar.
- ✓ Remote interface controller and control cable.

Each Ducted Split Wine Guardian Condenser Contains the following:

- ✓ A filter dryer to keep the refrigerant clean and free of contaminants.
- ✓ A sight glass to observe the level of refrigerant.
- ✓ A manual reset high pressure switch on the discharge to protect the compressor from high pressures.
- ✓ Auto reset low pressure switch.
- ✓ 24-volt contactor for control of fan coil unit.
- ✓ Outdoor enclosure.
- ✓ Crankcase heater.
- ✓ Low ambient refrigeration controls (see page 10 for Extreme Climate Protection option).

The Wine Guardian 60Hz models meets or exceeds its rated capacities for total BTU/H and CFM at design cellar conditions and external static pressures. The Wine Guardian 50Hz models meets or exceeds its rated capacities for total watts and cubic liters per second at design cellar conditions and external static pressures. Both the evaporator and condenser fans are capable of achieving the rated CFM against the external static pressure imposed by recommended ductwork. Both fans are motorized impeller plug fans, statically and dynamically balanced, and use permanently lubricated, direct drive motors that require no maintenance.

All exterior framing of the Wine Guardian's Evaporator is powder-coated aluminum to prevent rust and corrosion. All evaporator coils are aluminum tubes and aluminum fins with a protective anti-corrosion coating. The unit uses an external drain to remove excess moisture and not reintroduce it into the cellar or ambient space. Multiple removable access doors are provided to facilitate cleaning and maintenance, duct connections, and access to components and wiring.

All exterior framing of the Wine Guardian's Condenser is Anodized Aluminum to prevent rust and corrosion. Each Condensing unit houses a compressor. Compressors are rotary, self-lubricating, permanently sealed, hermetic reciprocating type compressors, with internal overload protection and capacitor start with a minimum of one-year manufacturer's warranty and an optional five-year warranty. Compressors are mounted on rubber-in-shear isolators to reduce noise and vibration.

Each unit is provided with a pre-wired and tested electronic digital thermostat for remote mounting in the cellar. The thermostat has multiple control functions for the fans, cooling, and heating. It has a fully automatic mode to switch between heating and cooling.

Electric power is supplied by a single factory-furnished cord and plug. All external controls are digital and proprietary to Wine Guardian products. Only the approved communication cable and Wine Guardian controllers are suitable for proper system operation.

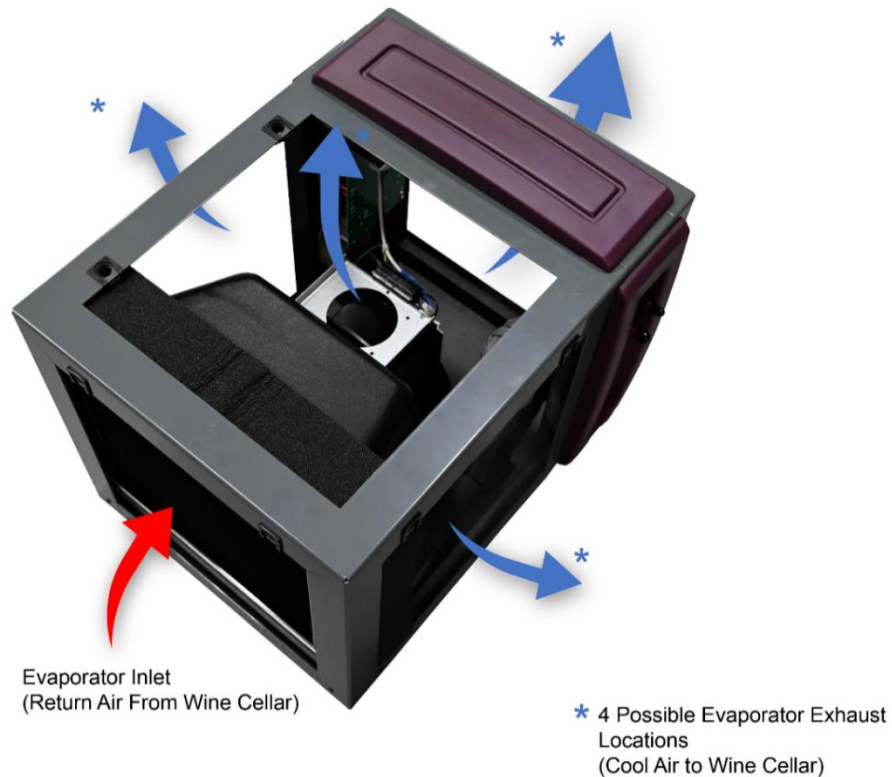

Accessories/Options

All Wine Temperatures (AWT)

A serving-temperature defrost sensor and an electric heating element are installed during production. The electric heating option is factory installed and includes primary and secondary over-temperature protection devices per UL and NEC.

Extreme Climate Protection

This bundle includes both a factory-installed Low-Ambient-, and a factory-installed High-Ambient upgrade. Low-Ambient protection makes the Wine Guardian capable of exposure to low ambient temperatures. This feature controls the condenser fan operation based on head pressure and heats the oil reservoir, including a 3R Condenser Fan. We recommend this bundle if the system will experience condenser inlet temperatures below 20°F (-7°C) or above 115°F (37°C) to protect the system itself. This bundle will protect the system from temperatures as low as -20°F (-29°C) or as high as 115°F (46°C)

- Check valve – installed in the liquid line between the head pressure control valve and receiver.
- Fan cycling switch.
- Heater – for the receiver with thermostat control.
- Adjustable low - pressure cutout timer.
- Anti-Corrosion Coating – a coating on the Condenser Coil to protect against salt air and other corrosive environments.

Humidifier and Humidistat

Another popular option for the Wine Guardian split system is a humidifier. The humidifier is available as a freestanding unit powered by the Wine Guardian system, with its own power cord and humidistat or as an integrated unit that bolts to the side of any Wine Guardian ducted system. The Wine Guardian humidifier requires a water supply and drain for operation. Please refer to the Humidifier Manual for Installation Instructions.

Duct Collar Kits

Ductwork for the Wine Guardian system is sold in kits by size for each unit. Each kit contains two adapter collars, one 25-foot (7.3 meters) length of round flexible duct, and two straps. The number of duct kits needed depends on the installation layout. The size of the ductwork kit depends on the selected model of Wine Guardian system. Follow installation instructions carefully. Poorly or incorrectly installed ducts can degrade the performance of your unit dramatically.

Extended Compressor Warranty

The Wine Guardian uses only the best commercially available compressors on the market. However, since the compressor is the single most expensive component in the unit, it is recommended that you purchase the extended warranty option.

Component Overview

Cabinet – The cabinet (outer housing) is constructed of aluminum with a powder-coated finish for corrosion protection.

Condensing Section – Ambient air is circulated through the condenser section by a direct drive, permanently lubricated, motorized impeller blower. This section also contains the compressor.

Evaporator Section – Cellar air is circulated through the evaporator section by another blower, similar to the condensing section. The large evaporator-coil face area eliminates condensate carry-over, reduces air pressure drop and optimizes heat transfer. A drain pan is located directly below the coil to capture condensate and is fabricated from aluminum to prevent rust and corrosion. The electric heating coil, if ordered, is factory installed between the evaporator coil and the blower and is complete with contactors and limit controls.

Electrical Controls – Most of the electrical components and controls are in a separate area accessible on the side of the unit. All wiring is in accordance with the NEC. Wires are numbered and color coded to match the wiring diagrams.

Internal Drain Trap - Water condensate from the evaporator coil fills the trap and forms a seal to prevent air from being drawn back through the drain tube. This allows the drain pan to drain freely. **No external trap is required.**

Supply/Return Duct Collar – A composite-material, single-direction duct collar is provided for both the inlet and outlet of the evaporator section. Two duct collars are provided with the unit; every duct collar is interchangeable with access doors to control and direct the airflow. These duct collars can be removed via the two quarter-turn screws.

Refrigerant Circuit – The factory charged circuit includes a thermal expansion valve with an external equalizer, sight glass with moisture indicator, a filter dryer, an automatic low-pressure switch, and a manual reset high-pressure switch. For the Extreme Climate Protection option, an automatic pressure switch controls the operation of the condenser blower, and a heating element is added to the compressor oil reservoir.

Removable Panels – Insulated composite-material removable panels are provided on the evaporator of the unit. These panels can be removed via the two quarter-turn screws.

Overview of the Evaporator

DS025, WGS40 Evaporator Fig.1

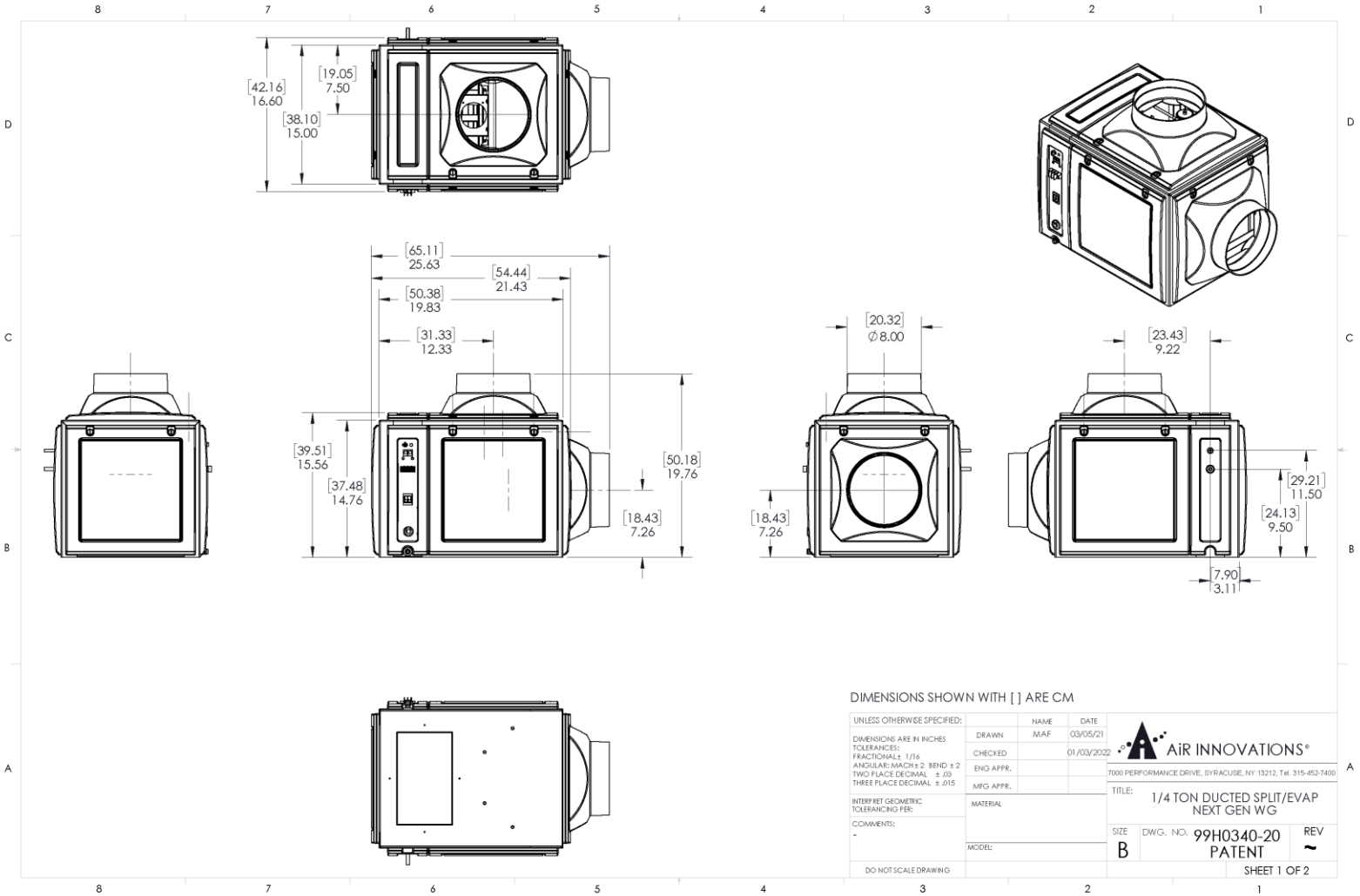

DS050, WGS75, DS088, WGS100, DS200, WGS175 Evaporator Fig.2

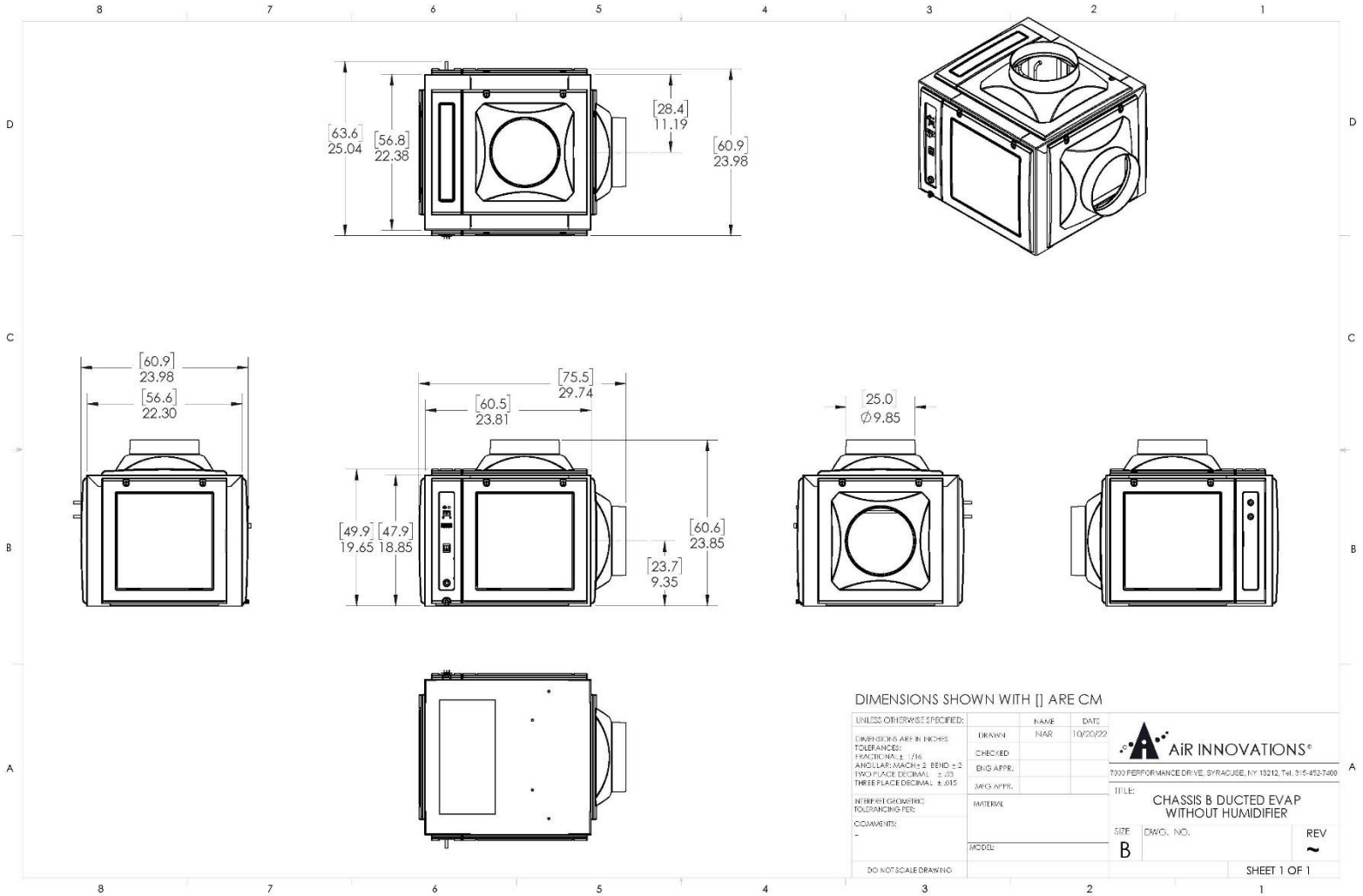

Overview of the Condenser

Fig. 3

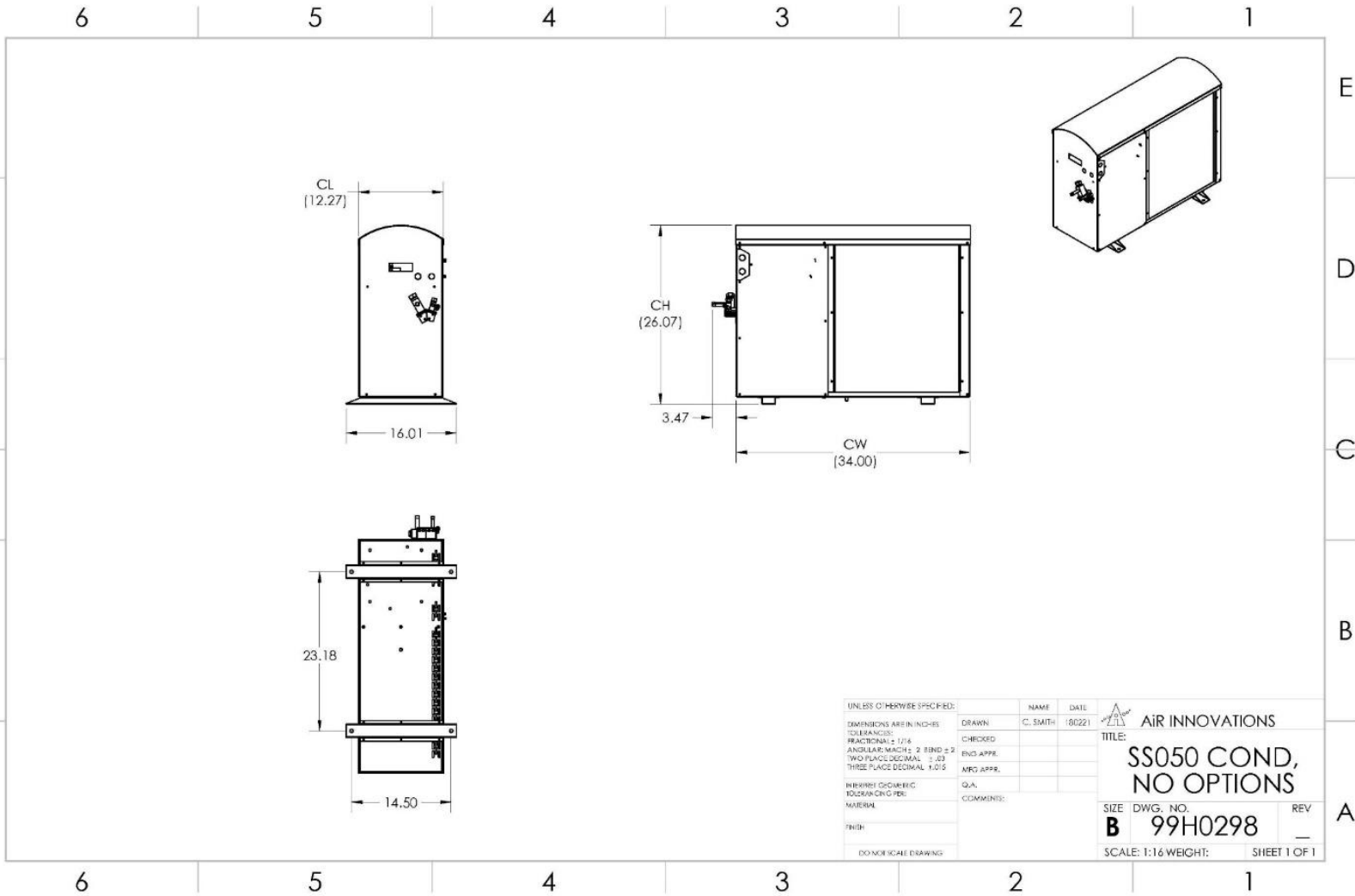

Refrigeration Illustration

Fig. 4

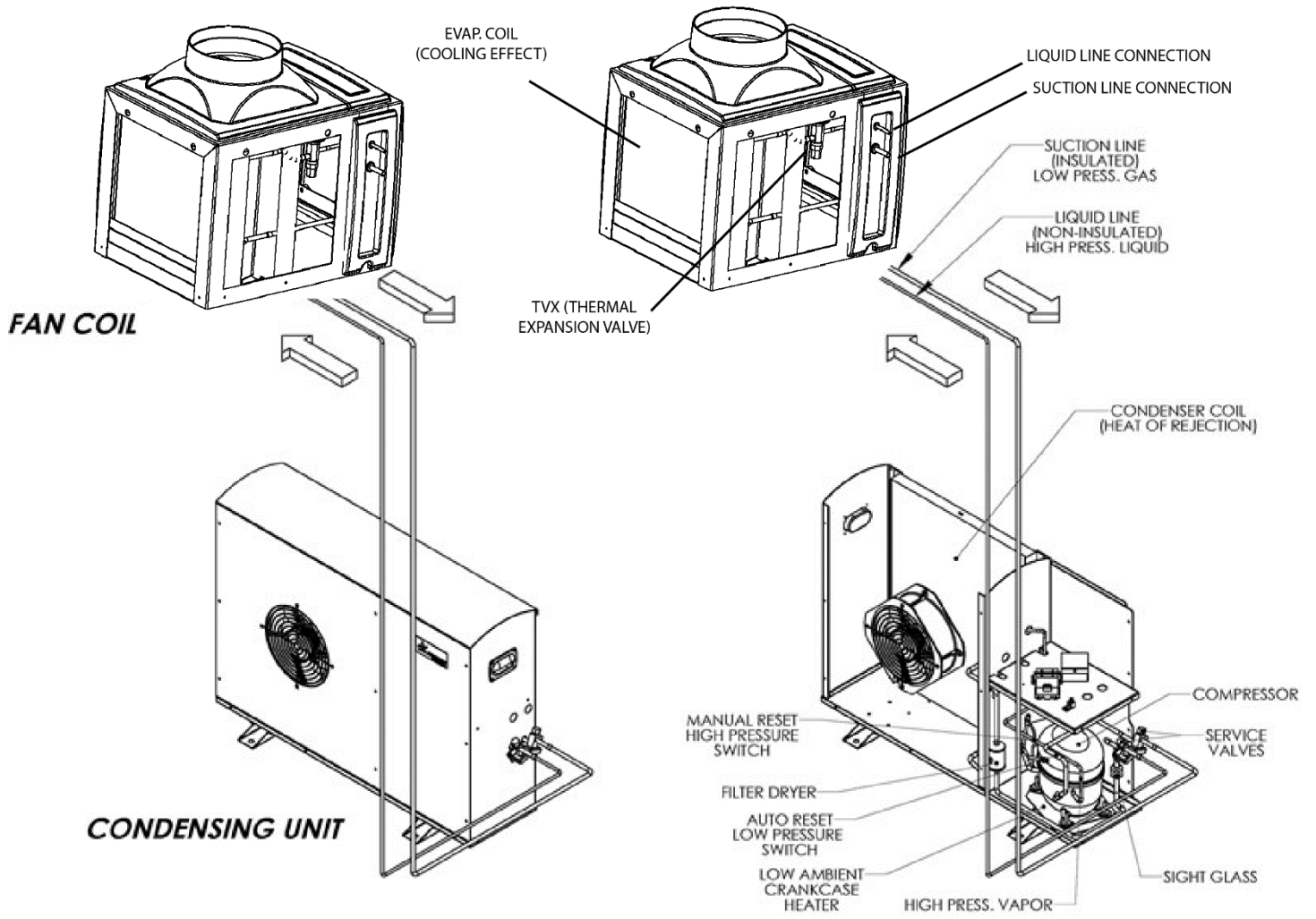

Wiring Diagram for DS025, DS050, WGS40, WGS75, WGS100 Evap

Fig. 5

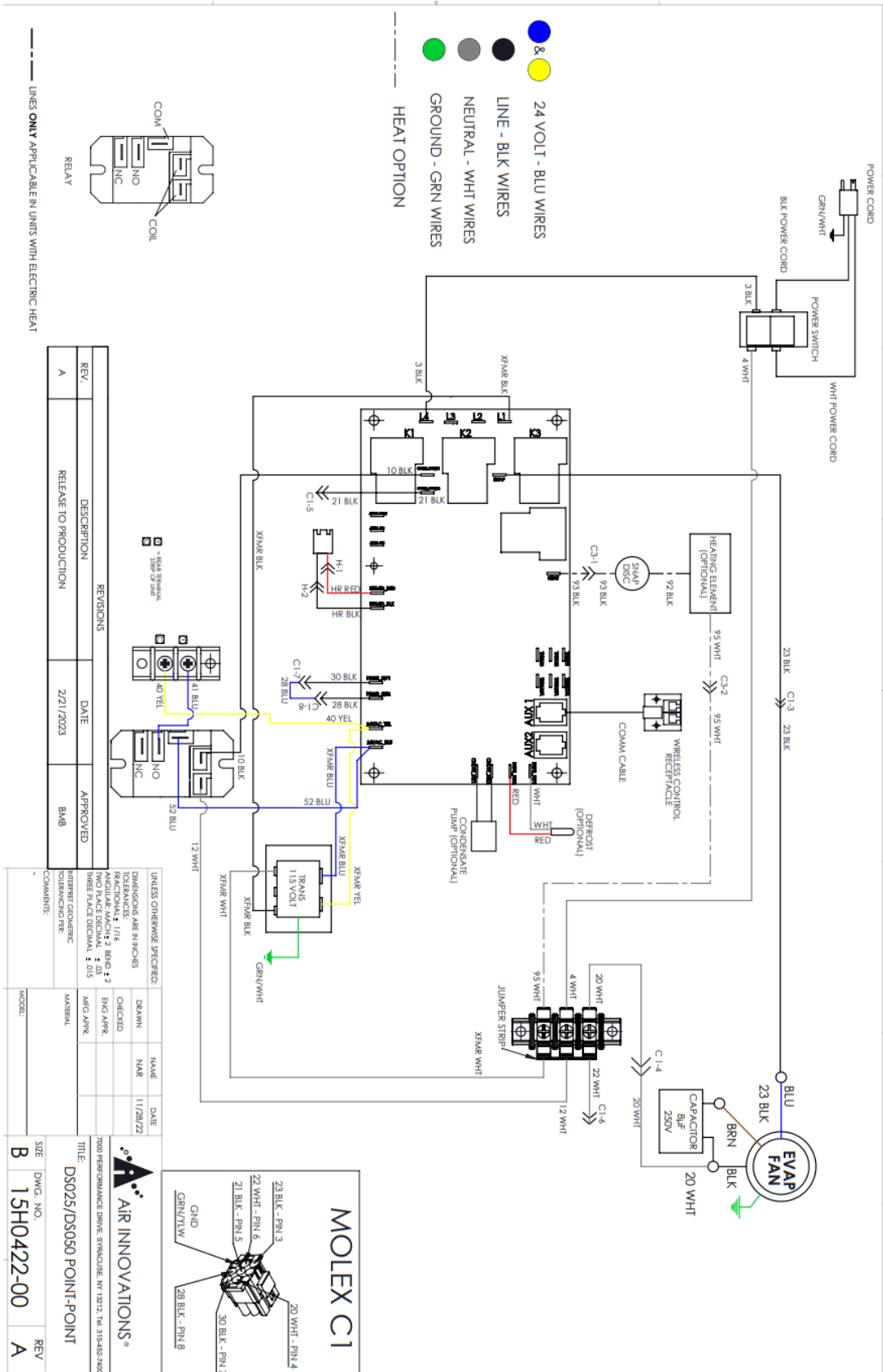

Wiring Diagram for DS025, DS050, WGS40, WGS75, WGS100 Cond

Fig. 6

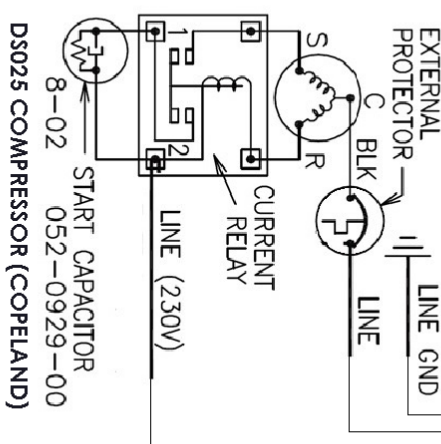
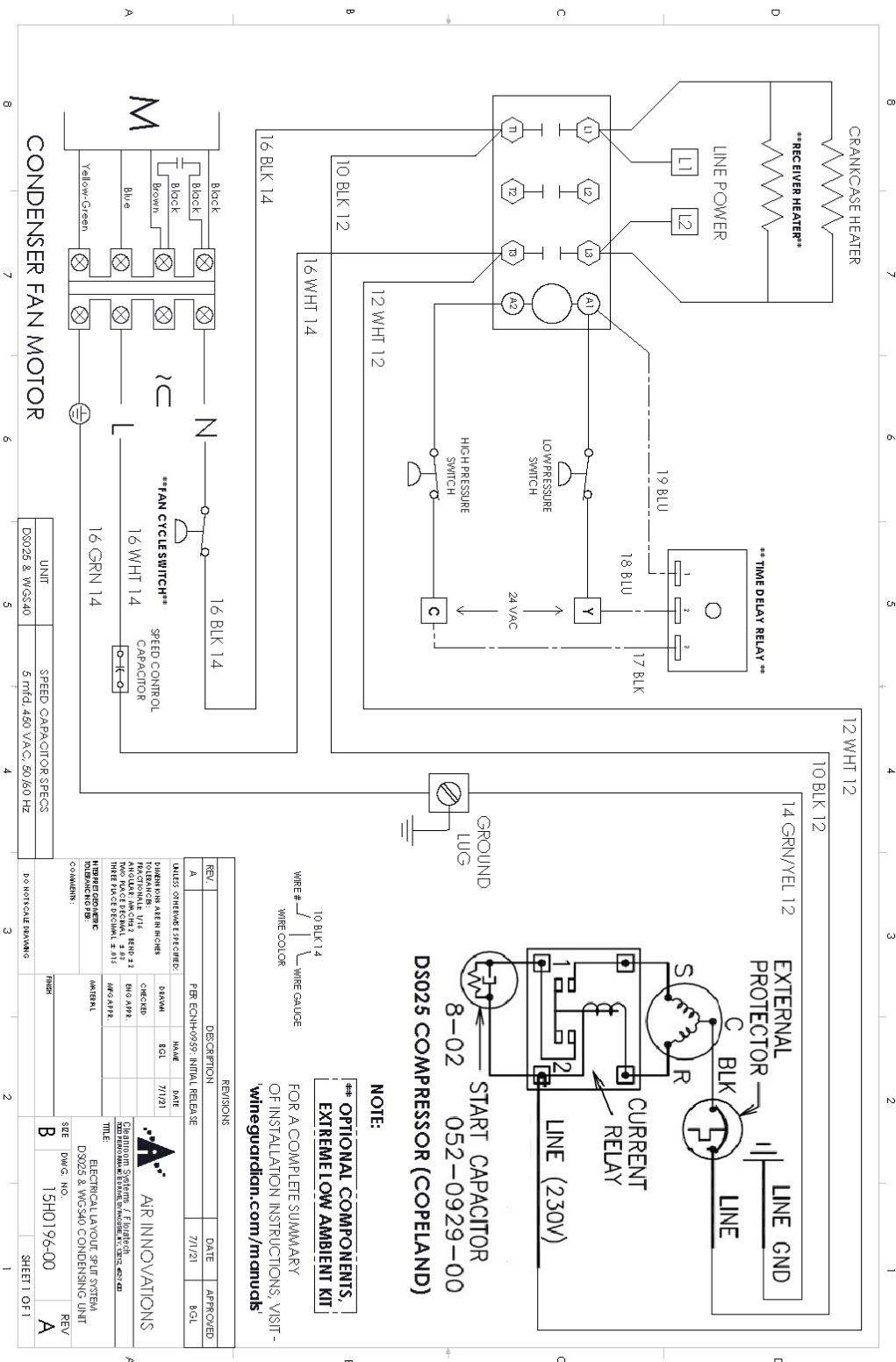

NOTE:

**OPTIONAL COMPONENTS,
EXTREME LOW AMBIENT KIT**

FOR A COMPLETE SUMMARY
OF INSTALLATION INSTRUCTIONS, VISIT -
wineguardian.com/manuals

REV.	DESCRIPTION	DATE	APPROVED
A	PER ECNH-09597 INITIAL RELEASE	7/1/21	BGL

QTY	DESCRIPTION	DATE	APPROVED
	PER ECNH-09597 INITIAL RELEASE	7/1/21	BGL

REV.	DESCRIPTION	DATE	APPROVED
A	PER ECNH-09597 INITIAL RELEASE	7/1/21	BGL

REV.	DESCRIPTION	DATE	APPROVED
A	PER ECNH-09597 INITIAL RELEASE	7/1/21	BGL

REV.	DESCRIPTION	DATE	APPROVED
A	PER ECNH-09597 INITIAL RELEASE	7/1/21	BGL

Wiring Diagram for DS025, DS050, WGS40, WGS75, WGS100 Control Board

Fig. 7

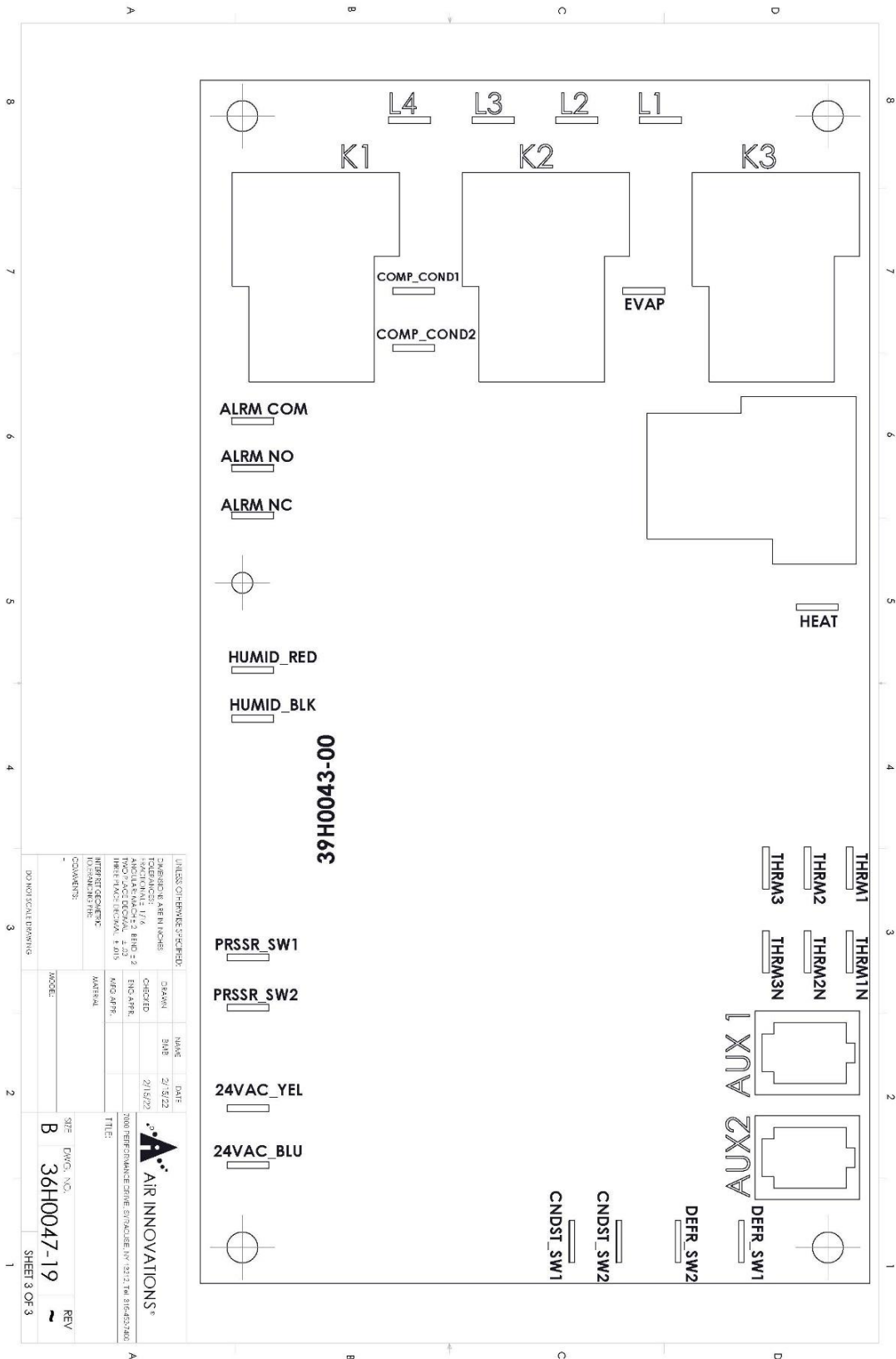

UNLESS OTHERWISE SPECIFIED:		NAME	DATE
DESIGNER:	AE IN INCHES	BUD	2/7/22
TOLERANCES:	FRA		
ANGLES:	MINIMUM 45°		
WALL THICKNESS:	0.005		
DRILLING:	0.015		
FINISH:	AS SUPPLIED		
INTERFERENCES:	RESOLVE		
COMMENTS:			

REV	DATE	BY	APP	DESCRIPTION
B	3/6/22	BUD		ISSUE FOR MANUFACTURE

36H0047-19

REV

SHEET 3 OF 3

Wiring Diagram for DS088, WGS100 Evap

Fig. 8

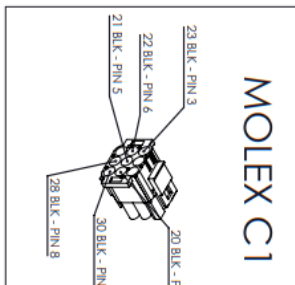
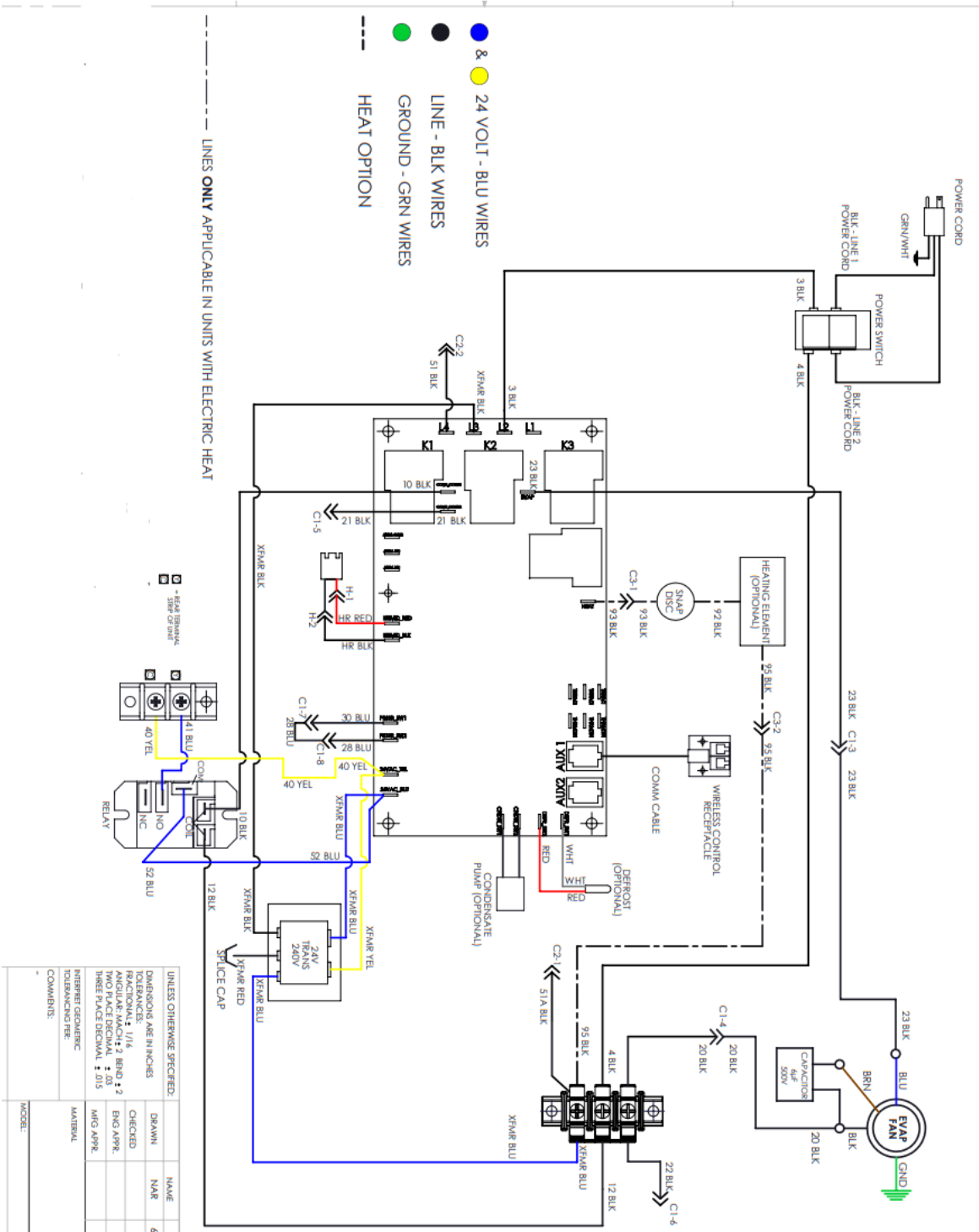

UNLESS OTHERWISE SPECIFIED:	
DIMENSIONS ARE IN INCHES	NAME DATE
FRACTIONAL 1/16	DRAWN NAR 6/2/22
CHECKED	
ANGULAR MACH: 2 BEND: 2	
TWO PLACE DECIMAL: .03	
MFG APPR:	
THREE PLACE DECIMAL: .010	
INTERPRET GEOMETRIC TOLERANCING PER:	
POTENTIAL CONCERN:	
MATERIAL:	
COMMENTS:	

7000 PERFORMANCE DRIVE, SPRINGFIELD, NV 89212 TEL: 315-452	SIZE	DWG. NO.	REV
AIR INNOVATIONS	B	15H0423-00	A
DS088 POINT-POINT			

Wiring Diagram for DS088, WGS100 Cond

Fig. 9

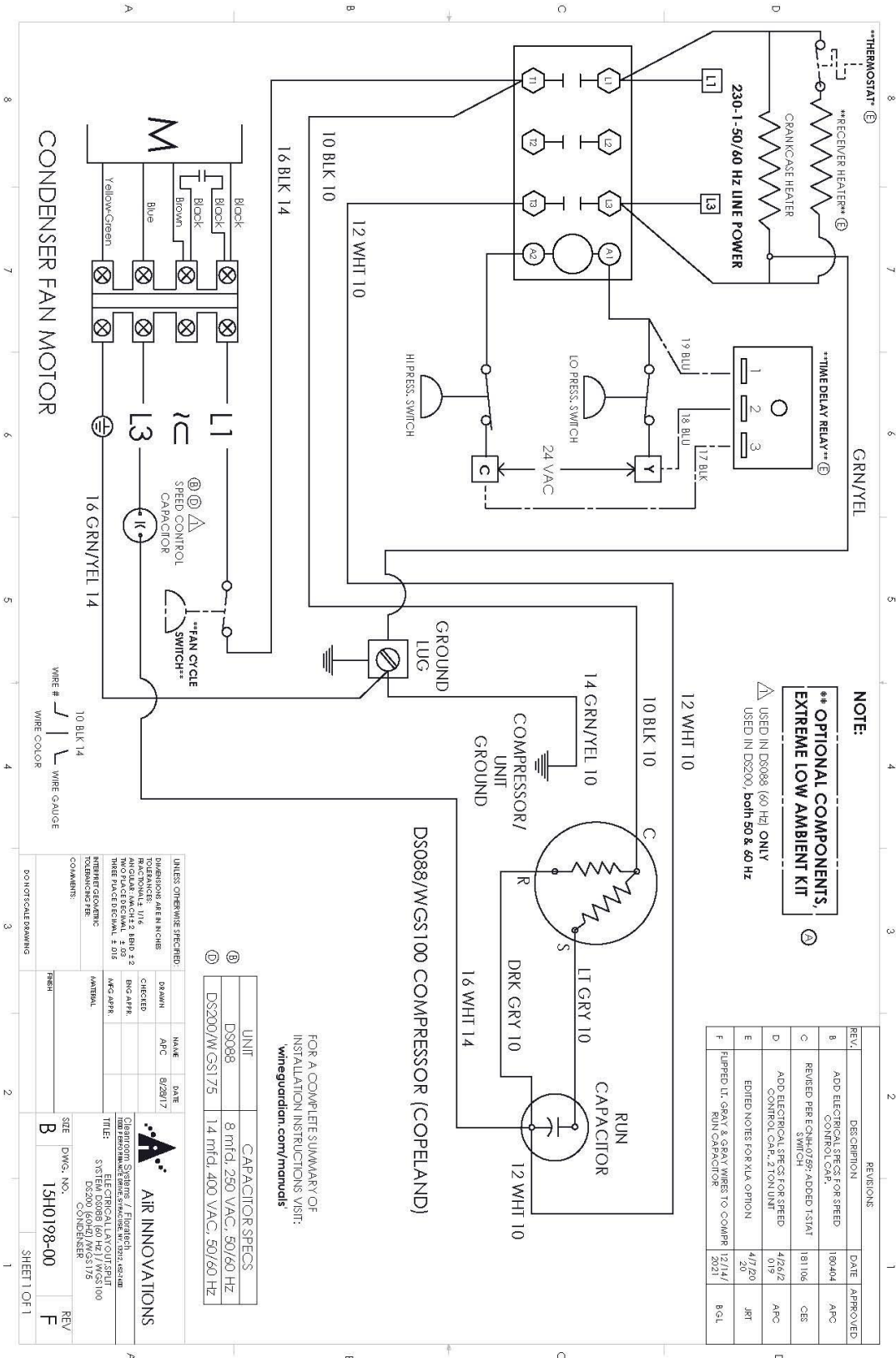

Wiring Diagram for DS200, WGS175 Evap

Fig. 10

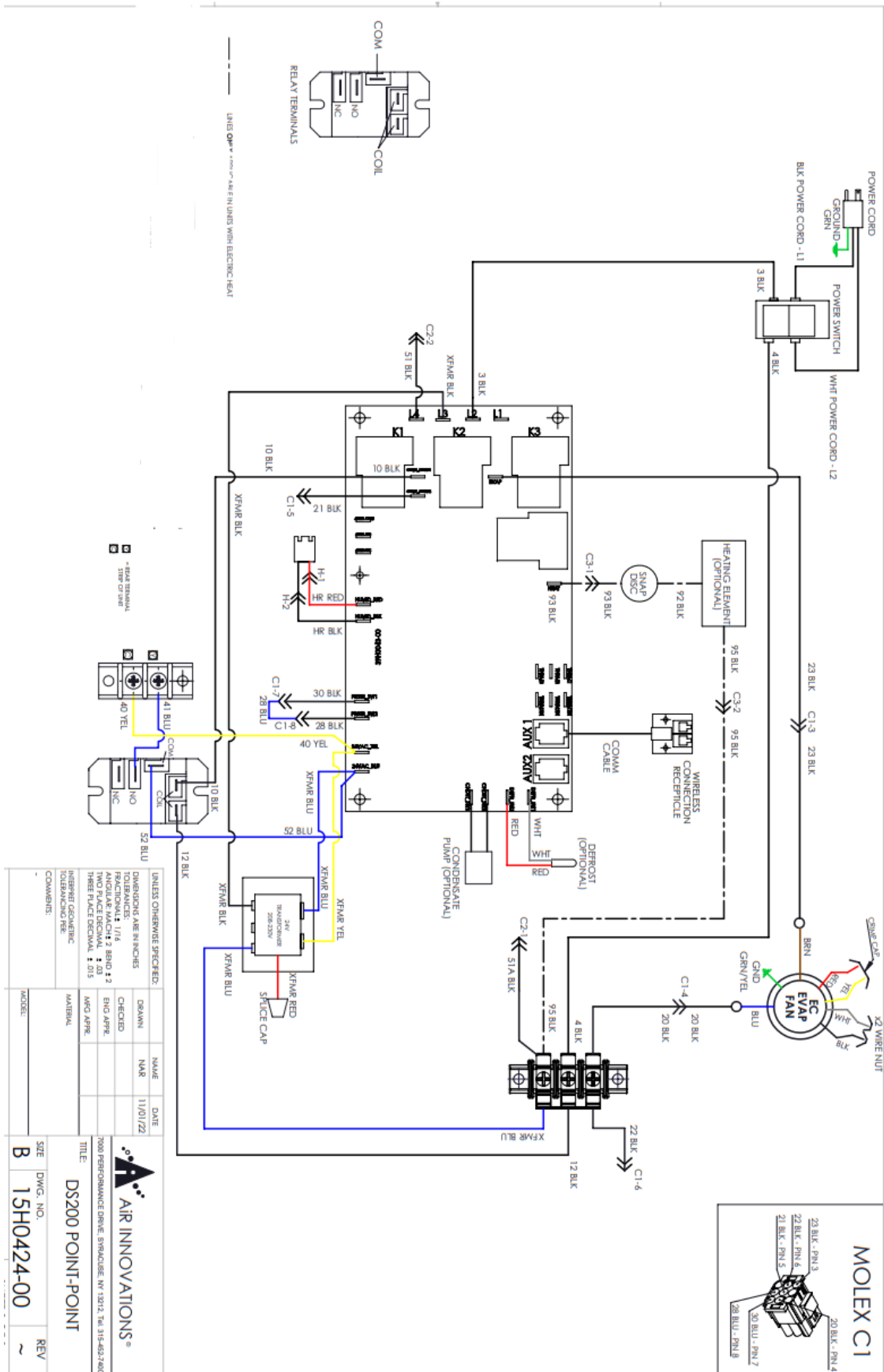

Wiring Diagram for DS200, WGS175 Cond

Fig. 11

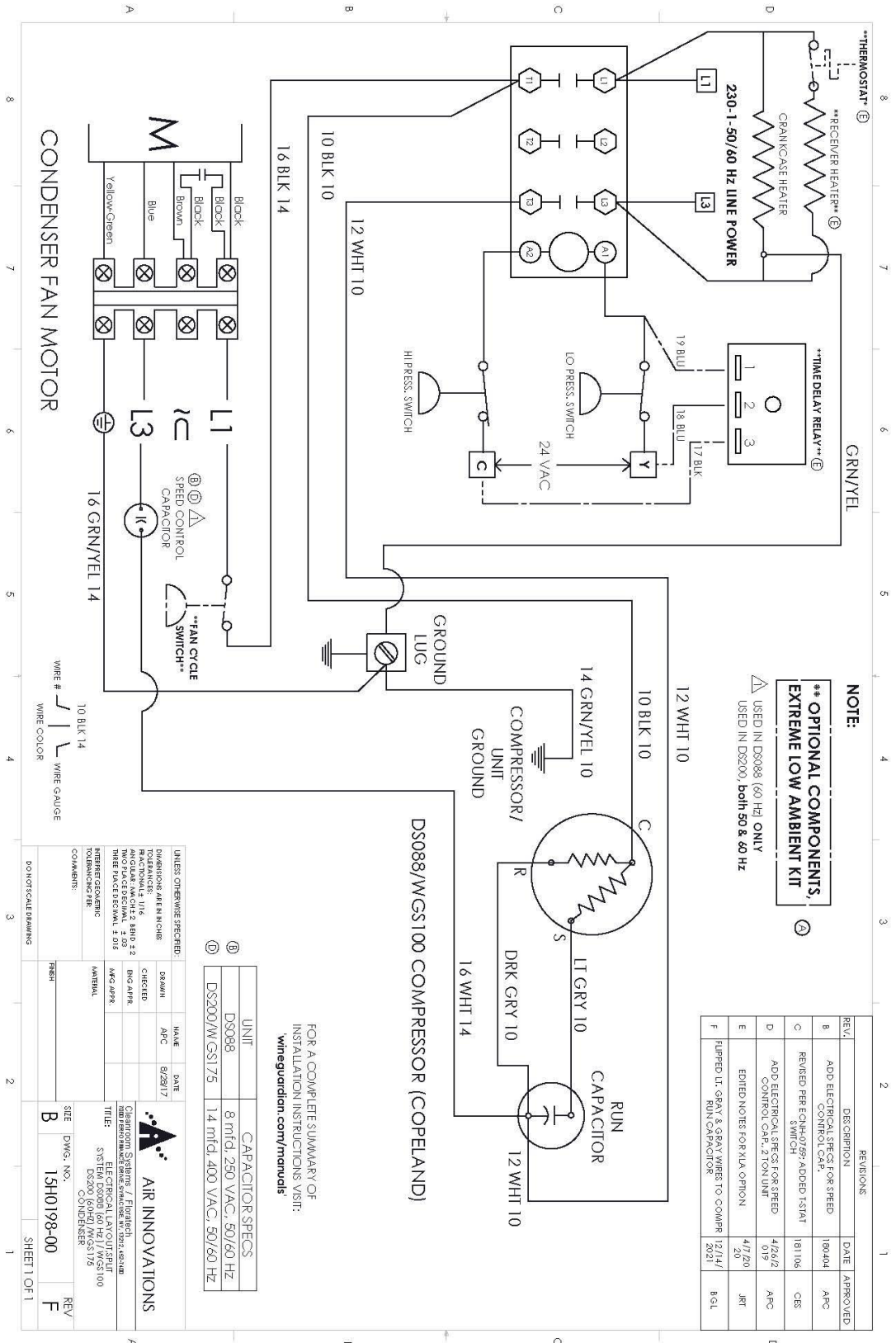

Specifications

Wine Guardian Specification Sheet – 60Hz models



Specifications

Ducted Split System

Model Number	DS025	DS050	DS088	DS200
Performance				
Net Cooling * Total Sensible	Total/Sensible @208-230V	Total/Sensible @208-230V	Total/Sensible @208-230V	Total/Sensible @208-230V
@10°F (minus 12°C) condenser inlet air	4100/3178 BTUH	5535/4203 BTUH	10763/8610 BTUH	N/A
@40°F (4°C) condenser inlet air	3793/3178 BTUH	6458/5023 BTUH	10865/8815 BTUH	17118/11173 BTUH
@60°F (15°C) condenser inlet air	3485/3075 BTUH	6765/5330 BTUH	10455/8405 BTUH	17425/11173 BTUH
@70°F (21°C) condenser inlet air	3690/3075 BTUH	6663/5125 BTUH	10353/7893 BTUH	16195/10968 BTUH
@80°F (27°C) condenser inlet air	3485/3178 BTUH	6458/5023 BTUH	9840/7688 BTUH	15785/10455 BTUH
@100°F (32°C) condenser inlet air	3178/2768 BTUH	5740/4510 BTUH	9225/7073 BTUH	14145/9738 BTUH
@115°F (46°C) condenser inlet air	2973/2563 BTUH	5125/3793 BTUH	8713/6663 BTUH	12608/8815 BTUH
@122°F (50°C) condenser inlet air	2460/2460 BTUH	4818/3485 BTUH	N/A	N/A
Controls				
Type	Room mounted non-programmable combination thermostat humidistat			
Temperature Accuracy/RH% Accuracy	+/- 1 Deg F		+/- 10% RH	
Fan-coil Section				
Fan Motor Size	90 Rated Watts	115 Rated Watts	220 Rated Watts	180 Rated Watts
Rated Air Flow (free blow)	236 CFM	410 CFM	482 CFM	759 CFM
Rated Air Flow @ Max allow pressure loss	226 @ 0.10"wc / CFM	359 @ 0.20" wc / CFM	457 @ 0.20" wc / CFM	728 CFM @ 0.35" wc / CFM
Heat (Option)				
Type	Electric	Electric	Electric	Electric
Capacity	1000 Watts	1000 Watts	2000 Watts	2000 Watts
Humidifier (Option)				
Type	Removeable drip pad with integral fan			
Capacity - water temp of 60°F (15°C)	0.42 lbs/hr			
Capacity - water temp of 90°F (32°C)	0.97 lbs/hr			
Capacity - water temp of 120°F (49°C)	1.11 lbs/hr			
Electrical Requirements - Evaporator Section				
Power	115 Volts/1 phase/60Hz	115 Volts/1 phase/60Hz	208-230Volts/1 phase/60Hz	208-230Volts/1 phase/60Hz
Current Draw - Cooling mode	0.8 Amps	0.9 Amps	0.8 Amps	0.8 Amps
Current Draw - Heating mode	9.4 Amps	9.6 Amps	9.5 Amps	9.5 Amps
Minimum Circuit Size (w/heat option)	11.6Amps	11.8 Amps	11.7 Amps	11.7 Amps
Optional Humidifier	0.3 Amps	0.3 Amps	0.3 Amps	0.3 Amps
Cabinet - Evaporator Section				
Fan coil construction	Aluminum chassis & UL rated plastic panels			
Finish	Gray metal epoxy powder coat/textured PVC Acrylic blend			
Weight	35lbs	54lbs	58lbs	69lbs
Length	21.43 Inches	23.81 Inches	23.81 Inches	23.81 Inches
Width	16.60 Inches	25.04 Inches	25.04 Inches	25.04 Inches
Height	15.56 Inches	19.65 Inches	19.65 Inches	19.65 Inches
Condensate Drain	0.5 Inches	0.5 Inches	0.5 Inches	0.5 Inches
Condensing Unit				
	DS025 Cond	DS050 Cond	DS088 Cond	DS200 Cond
Nominal Compressor	3.1 Amps	4.8 Amps	11.3 Amps	11.3 Amps
Fan Motor Size	75 Watts	75 Watts	150 watts	150 watts
Rated Air Flow (free blow)	275 CFM	375 CFM	420 CFM	875 CFM
Weight	75 lbs	76 lbs	96 lbs	120 lbs
Enclosure - Condensing Unit				
Construction	Aluminum			
Finish	Anodized			
Width	12 Inches	12 Inches	12 Inches	12 Inches
Length	34 Inches	34 Inches	34 Inches	34 Inches
Height	26 Inches	26 Inches	26 Inches	26 Inches
Electrical Requirements - Condensing Unit				
Power	208/230 Volts/1 Phase/60Hz	208/230 Volts/1 Phase/60Hz	208-230 Volts/1 Phase/60Hz	208-230 Volts/1 Phase/60Hz
MCA	4.2 Amps	6.4 Amps	14.9 Amps	24.4 Amps
MOP	8.0 Amps	10.0 Amps	25 Amps	40 Amps
Agency Approval(s)				
	ETLc			

1. Net cooling capacity at entering temperature and humidity conditions of 57 Deg F (14 Deg C) and 55% RH at rated airflow. Reduce capacity by 3% for each 10% reduction in evaporator airflow.
 2. Wine Guardian reserves the right to make changes to this document without prior notice at its sole discretion.
 3. All ratings at sea level.
 4. All btuh capacity and airflow (CFM) values shown are at tested 230v applied on 208/230v rated units (Condensing units and larger evaporators). If field application allows 208v applied to the units dual rated, you can generally expect 2.5%-3.0% decreases in values shown.

Wine Guardian Specification Sheet – 50Hz models

Specifications



Ducted Split System

Model Number	WGS40	WGS75	WGS100	WGS175
Performance				
Net Cooling * Total Sensible	Total/Sensible @220-240V	Total/Sensible @220-240V	Total/Sensible @220-240V	Total/Sensible @220-240V
@10°F (minus 12°C) condenser inlet air	1140/879 Watts	1600/1300 Watts	2960/2315 Watts	N/A
@40°F (4°C) condenser inlet air	1140/937 Watts	1780/1460 Watts	2930/2285 Watts	4520/3230 Watts
@60°F (15°C) condenser inlet air	1115/860 Watts	1715/1440 Watts	3077/2256 Watts	4530/2970 Watts
@70°F (21°C) condenser inlet air	1110/850 Watts	1750/1380 Watts	2930/2168 Watts	4420/3000 Watts
@80°F (27°C) condenser inlet air	1055/835 Watts	1550/1310 Watts	2813/2110 Watts	4100/2880 Watts
@100°F (32°C) condenser inlet air	965/730 Watts	1360/1150 Watts	2520/1846 Watts	3900/2720 Watts
@115°F (46°C) condenser inlet air	850/675 Watts	1300/1080 Watts	2373/1758 Watts	3490/2440 Watts
@122°F (50°C) condenser inlet air	640/640 Watts	1200/1000 Watts	N/A	N/A
Controls				
Type	Room mounted non-programmable combination thermostat humidistat			
Temperature Accuracy/RH% Accuracy	+/- 1 Deg F		+/- 10% RH	
Fan-coil Section				
Fan Motor Size	85 Rated Watts	120 Rated Watts	230 Rated Watts	290 Rated Watts
Rated Air Flow (free blow)	390 M ³ /h	680 M3h	750 M3h	1325 M3h
Rated Air Flow @ Max allow pressure loss	374 M ³ /h	680 M3h	750 M3h	1200 M3h
Heat (Option)				
Type	Electric	Electric	Electric	Electric
Capacity	1000 Watts	1000 Watts	2000 Watts	2000 Watts
Humidifier (Option)				
Type	Removeable drip pad with integral fan			
Capacity - water temp of 60°F (15°C)			.19 kg/hr	
Capacity - water temp of 90°F (32°C)			.44 kg/hr	
Capacity - water temp of 120°F (49°C)			0.5 kg/hr	
Electrical Requirements - Evaporator Section				
Power	220-240Volts/1 phase/50Hz	115 Volts/1 phase/60Hz	208-230Volts/1 phase/60Hz	208-230Volts/1 phase/60Hz
Current Draw - Cooling mode	0.4 Amps	0.5 Amps	1.0 Amps	1.0 Amps
Current Draw - Heating mode	4.75 Amps	4.7 Amps	10.7 Amps	10.7 Amps
Minimum Circuit Size (w/heat option)	5.84 Amps	5.75 Amps	13.1 Amps	13.1 Amps
Optional Humidifier	0.3 Amps	0.3 Amps	0.3 Amps	0.3 Amps
Cabinet - Evaporator Section				
Fan coil construction	Aluminum chassis & UL rated plastic panels			
Finish	Gray metal epoxy powder coat/textured PVC Acrylic blend			
Weight	15.87kg	24.5kg	25.4kg	31.3kg
Length	54.43 cm	61 cm	61 cm	61 cm
Width	42.16 cm	56.85 cm	56.85 cm	56.85 cm
Height	39.52 cm	48 cm	48 cm	48 cm
Condensate Drain	12.7 mm	12.77 mm	12.77 mm	12.77 mm
Condensing Unit				
	WGS40 Cond	WGS75 Cond	WGS100 Cond	WGS175 Cond
Nominal Compressor	2.6 Amps	3.9 Amps	10.8 Amps	10.8 Amps
Fan Motor Size	68 Watts	85 Watts	120 watts	120 watts
Rated Air Flow (free blow)	850 M ³ /h	850 M3h	739 M3h	1486 M3h
Weight	34 kg	36 kg	44 kg	54 kg
Enclosure - Condensing Unit				
Construction	Aluminum			
Finish	Anodized			
Width	86.4 cm	86.4 cm	86.4 cm	86.4 cm
Length	30.5 cm	30.5 cm	30.5 cm	30.5 cm
Height	66 cm	66 cm	66 cm	66 cm
Electrical Requirements - Condensing Unit				
Power	220-240 Volts/1 Phase/50Hz	220-240 Volts/1 Phase/50Hz	220-240 Volts/1 Phase/50Hz	220-240 Volts/1 Phase/50Hz
MCA	3.7 Amps	5.2 Amps	14.2 Amps	14.2 Amps
MOP	6.0 Amps	9.0 Amps	20 Amps	20 Amps
Agency Approval(s) CE				

1. Net cooling capacity at entering temperature and humidity conditions of 57 Deg F (14 Deg C) and 55% RH at rated airflow. Reduce capacity by 3% for each 10% reduction in evaporator airflow.
2. Wine Guardian reserves the right to make changes to this document without prior notice at its sole discretion.
3. All ratings at sea level.

Installation

For questions or help regarding installation, call customer service at 1-315-452-7400 or email info@wineguardian.com a sketch of the proposed area where the unit is to be installed.

Pre-Installation

Test the system before installing it to check for non-visible shipping damage.

- ✓ Set the system on the floor or on a sturdy, level surface.
- ✓ Ensure the control cable and remote interface controller are plugged into one of the com ports.
- ✓ Plug in the system.
- ✓ Press the on/off switch to see if the control illuminates. This indicates the system has power.



**RISK OF PERSONAL INJURY OR DAMAGE TO EQUIPMENT
SHARP EDGES ARE PRESENT INSIDE THE WINE GUARDIAN SYSTEM**

Pre-Installation Planning

IMPORTANT

Installation of residential and commercial split systems must be performed by qualified service technicians with proper training in the installation, start up, service, and repair of these systems. Certification to handle refrigerants is also required.

Prior to installation, determine how best to mount the system.

Installing The Fan-Coil

Floor Mounting - Mount the Wine Guardian fan coil on the floor but elevate it 4" (10cm) as a minimum on a frame with a plywood surface to keep it away from water. Allow adequate space for the external drain.

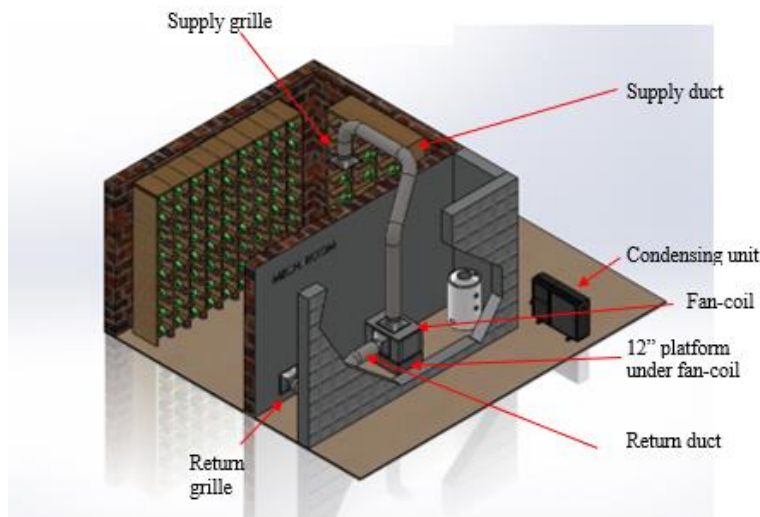

Wall Mounting - If the Evaporator is to be surface mounted on the wall, adequately support it on both sides of the wall. Use floor or knee braces to transfer the load of the unit to the floor or wall.

Ceiling Mounting - Construct a structurally sound, level platform to place the Evaporator on when hanging it from the ceiling joists. The Wine Guardian fan coil is NOT designed to be suspended from the top of the unit; it must be supported from the bottom. Place the unit on a platform to ensure the unit is supported on all four corners. Leave adequate space above the unit to remove the access doors for service.

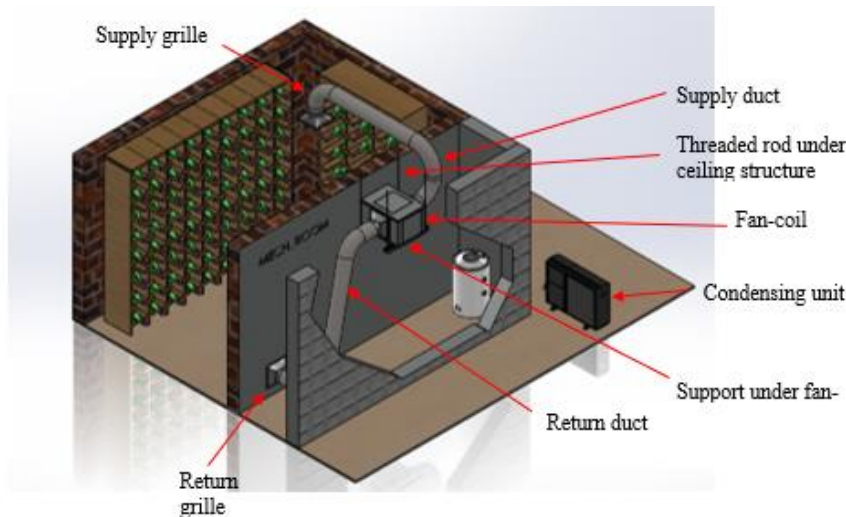

In all cases the unit must be level to within $\pm 0.25''$ ($\pm 6.35\text{mm}$) end-to-end and $\pm 1/8''$ ($\pm 3.18\text{mm}$) side-to-side for proper operation. Locate the unit as close to the wine cellar as possible to reduce the length of the duct runs. If possible, use straight ducting on all duct work.

Reducing Noise Generation

Consider noise when locating the unit close to the cellar or to an adjacent occupied space. The addition of 0.25" (6.35mm) thick rubber pads under the unit will help prevent the transmission of vibration and noise. A piece of 1" or 2" (25 or 50mm) noise dampener between the unit and the wall absorbs and reduces noise from the unit. For air noise, use flexible ductwork to absorb the noise. Sound usually travels as a line of sight. Sound is reduced when it turns a corner, such as passing through a bend in ductwork. If the unit is supported from a wall or joist, using a rubber pad under the unit will reduce noise caused by vibration.

Ductwork

Wine Guardian units are typically installed indoors near the wine cellar to minimize duct runs. Each unit is provided with one entering (or return) air inlet and five possible supply air outlets for the evaporator sections. A maximum cumulative total length for both supply and return ducts (including bends) of 25 ft (7.5 meter) is recommended. If longer runs are needed, examine your duct runs using our [Ductwork Calculator](#).

Use ductwork to connect the unit to the supply and return outlets in the wine cellar. Use only insulated ductwork to minimize cooling losses, to prevent sweating, and to reduce noise.

Use ductwork on the condenser section to redirect or absorb sound, to bring in outside air to the unit inlet, and/or to exhaust the hot air out of the ambient space.

Ductwork Diameters (inches) – Wine Guardian 60 Hz units		
Model #	Evaporator (cold air side)	
	Single Duct Run	Double Duct Run
DS025	8	6
DS050/DS088	10	8
DS200	12	10
Ductwork Diameters (millimeters) – Wine Guardian 50 Hz units		
Model #	Evaporator (cold air side)	
	Single Duct Run	Double Duct Run
WGS40	203.2	152.4
WGS75/WGS100	254	203.2
WGS175	305	254
It is best to oversize ductwork if exact ductwork diameters are not readily available or easily accessible		

Note: The above referenced sizes are internal diameter in inches for 60Hz and in millimeters for 50Hz. If a single supply duct is used but then splits into two ducts, the duct size that is recommended for double duct runs is used after the split occurs (ex. 8” duct would split into two 6” ducts).

Cold Air to/from Wine Cellar

- ✓ Connect the supply-air ductwork from the cellar to the supply-air duct collar at the Wine Guardian unit.
- ✓ Connect the return-air ductwork from the cellar to the return-air duct collar at the Wine Guardian unit.

Warm Air to/from Condenser

- ✓ Connect the supply-air ductwork from the condenser to direct heat and air noise away from occupants.
- ✓ Connect the supply-air ductwork from the condenser either outdoors or to a space that is 3x larger than the wine room if the heat being exhausted is undesirable.

Duct Collar and Panel Adjustment



Fig. 1



Fig. 2



Fig. 3



Fig. 4

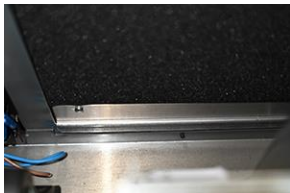

Fig. 5

To replace or adjust the locations of the panels and Supply Collar please see the instructions below:

1. Determine which panel needs to be replaced (Fig 1).
2. Use a flat blade screwdriver, coin, or other suitable tool at the captive fastener (Fig 2).
3. Apply a simple, quarter turn counterclockwise to allow the fastener to disengage from the housing (Fig 3).
4. Remove the panel by sliding the panel/collar up to disengage the bottom hook from the housing before completely removing the panel/collar from the unit (Fig 4).
5. To replace the panel/collar, simply reverse the previous steps. Press the panel against the opening and slide it down to connect the bottom hook of the panel/collar to the housing (Fig 5). Push the top of the panel in and line up the fasteners with holes in the housing. Insert the tool into the fastener and quarter turn it clockwise to lock into place.

Drain Line

Splice the drain line onto the drain outlet with a short piece of ½” copper tubing and secure the drain line to the unit with a hose clamp. The drain line’s interior diameter should be ½” (12.7mm). The drain line must extend from the unit to an open floor drain or condensate pump. Do **NOT** install an external trap on the drain line, every ducted Wine Guardian unit is built with an internal trap. Allow enough height for the drain line to function properly. If draining into a nearby sink, the unit must be elevated higher than the rim of the sink in order for the water to drain by gravity. Install with a ¼” (6.35mm) per linear foot of pitch. **Do not** tie the condensate drain line directly into the sanitary sewer system. The internal drain trap primes itself automatically once the unit has run for a period of time and after the unit cycles off. This is confirmed by water dripping from the drain.

Wiring the Fan-Coil

Match the Electrical Wiring to the cord provided on the Wine Guardian fan coil. Provide dedicated circuit and wiring for the system. Match the wiring and breaker size to the rated load as shown on the serial plate and in this guide. Please see the sample serial plate illustration.



MODEL: DS025

P/N : 99H0340-20

S/N : xx-xx-xxx

REV : X

Refrigerant	R-134A
System Charge	N/A
Test Pressure	275 psi
Electrical	115/1/60
Min. Circuit amps	.7
Compressor RLA	N/A
Locked Rotor Amps	N/A
Condenser Fan Amps	N/A
Evaporator Fan Amps	0.7
Humidifier Amps	0.3
Total Unit Amps	.7



DANGER



**ELECTRICAL SHOCK HAZARD
RISK OF SERIOUS INJURY OR DEATH**
**The electrical outlet and wiring installation must
meet the
national and local building codes.**



Intertek
59373

Conforms to UL STD 1995
Certified to CAN/CSA STD C22.2 NO. 236



AIR INNOVATIONS

7000 Performance Dr.
North Syracuse, New York USA 13212
help.wineguardian.com

FCC ID: 2AQX3-WG
IC ID: 24453-2AQX3WG

*This device complies with part 15 of the FCC Rules.
Operation is subject to the following two conditions:
1) This device may not cause harmful interference.*

and

*2) This device must accept any interference received,
including interference that may cause
undesired operation.*

S/N : xx-xx-xxx

MODEL: DS025

help.wineguardian.com

Do **NOT** modify the plugs in any way. Do **NOT** use extension cords.

Depending on the model, the electrical power supply must be either 115-volt or 230-volt AC, 1 phase, 60 cycle, and the electrical power cannot vary more than $\pm 4\%$ or damage may occur to the unit.

Plug the unit into the wall outlet, gently pull on the plug to make sure it is tight.

Fig. 1: Plug configurations

Required For:
Models D025

-115VAC, 60Hz
-NEMA 5-15P

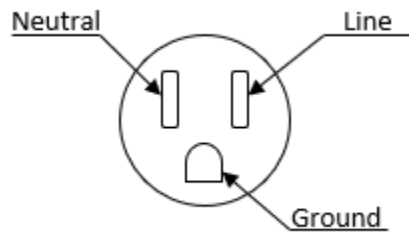

Required For:
Models D088

-230VAC, 60Hz
-NEMA 6-15P

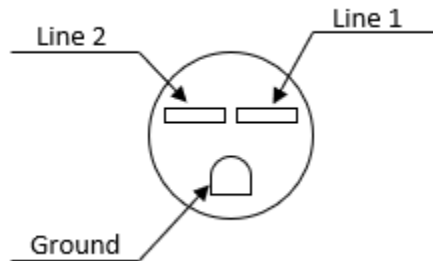

Required For:
Models D200

-230VAC, 60Hz
-NEMA 6-20P

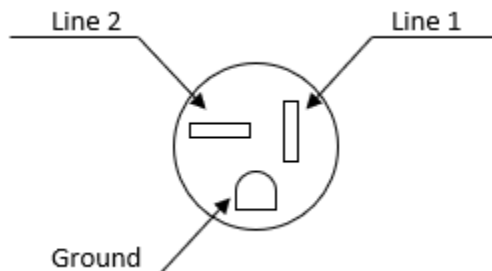

Installing The Condensing Unit

- Condensing units are factory assembled with an anodized aluminum outdoor enclosure for protection from the elements.
- A minimum of 12" (30cm) is required around the perimeter of the condensing unit for proper airflow across the coil and to provide an adequate discharge airflow path. Any obstructions to this airflow will result in a decrease in performance and possibly premature failure due to a buildup of high pressure within the system.
- The condensing unit is designed to operate in ambient temperatures ranging from 20°F-115°F (minus -7°C - 46°C), as it is supplied with many standard features to assist full operation in this wide range.
- Mount the condensing unit above normal snowfall levels to allow uninhibited winter operation. A buildup of snow or any other obstruction to airflow will result in a decrease in performance and possible premature failure due to increasingly high pressure within the system.

Installation of Interconnecting Refrigerant Lines

Note: The interconnecting copper refrigerant lines shall be supplied by the installer. The larger suction line must be fully insulated along its complete length from condensing unit to fan coil unit. There is a factory-installed liquid line filter-drier inside the condensing unit; therefore, no additional drier is needed for proper operation. A liquid line moisture/sight glass is factory installed in the condensing unit to assist in monitoring the refrigerant charge and the state of the refrigerant in the system.

- Keep horizontal and vertical distances between the indoor and outdoor section as close as possible to minimize refrigerant charge required. This will reduce system issues related to oil management that can impair performance and jeopardize the compressor's lubrication.
- Provide a ½" (12.7mm) pitch in suction and liquid line toward the condensing unit for every 10 ft (3 meters) of run to prevent any refrigerant that condenses in the suction line from flowing to the compressor when the unit is off. These two lines can be routed together and wrapped together, as long as the suction line is fully insulated, as previously directed.
- Suction line riser traps are not required if the riser is properly sized to maintain refrigerant velocity. Adding a trap will only increase pressure drop.
- Prevent dips, sags, or other low spots that will trap refrigerant oil, which is an issue especially with long horizontal runs. Use hard refrigerant copper for longer horizontal runs to prevent potential oil return problems. (See sample piping chart on page 34)
- When sweat connections are made in the connecting lines, be sure that the inside of the tubing is clean before installing the unit. Use a dry nitrogen bleed during brazing.

Note: that compressor suction and discharge valves should be open to the atmosphere no longer than 15 minutes. Compressors with POE (polyolester) oil will quickly become contaminated when opened to atmosphere.

Refrigerant Line-Sets

60 Hz Models

Model #	Liquid Line (OD)	Liquid Connection at Evaporator (OD)	Suction Line (OD)	Suction Connection at Evaporator (OD)	Min. Suction Line Insulation Thickness	Maximum "Total" Line Length	Maximum Lift (height)
DS025	1/4"	1/4"	3/8"	3/8"	3/8"	50'	15'
DS050	1/4"	1/4"	1/2"	3/8"	*3/8"	50'	15'
DS088	3/8"	*1/4"	5/8"	5/8"	*1/2"	50'	15'
DS200	3/8"	3/8"	3/4"	5/8"	*1/2"	50'	15'

***Interconnecting tube must be reduced at evaporator connection**

50 Hz Models

WGS40	0.635 cm	0.635 cm	0.952 cm	0.952 cm	0.952 cm	15.24 m	4.57 m
WGS75	0.635 cm	0.635 cm	1.27 cm	0.952 cm	0.952 cm ¹	15.24 m	4.57 m
WGS100	0.952 cm	0.635 cm	1.59 cm	1.59 cm	1.27 cm ²	15.24 m	4.57 m
WGS175	0.952 cm	0.952 cm	1.905 cm	1.59 cm	1.27 cm ³	15.24 m	4.57 m

¹ Use 1/2" (1.27 cm) to 3/8" (0.952 cm) reducer at evaporator

² Use 5/8" (1.59 cm) to 1/2" (1.27 cm) reducer at evaporator

³ Use 3/4" (1.91 cm) to 1/2" (1.27 cm) reducer at evaporator

Note:

- Line lengths are expressed in equivalent feet = actual run length + fitting allowances (i.e., ~5' (12.7 cm) for each bend/elbow allowance).
- Use only refrigeration-grade dehydrated tubing.
- Install refrigeration piping per local codes and ASHRAE guidelines.

Sample line Set Configurations

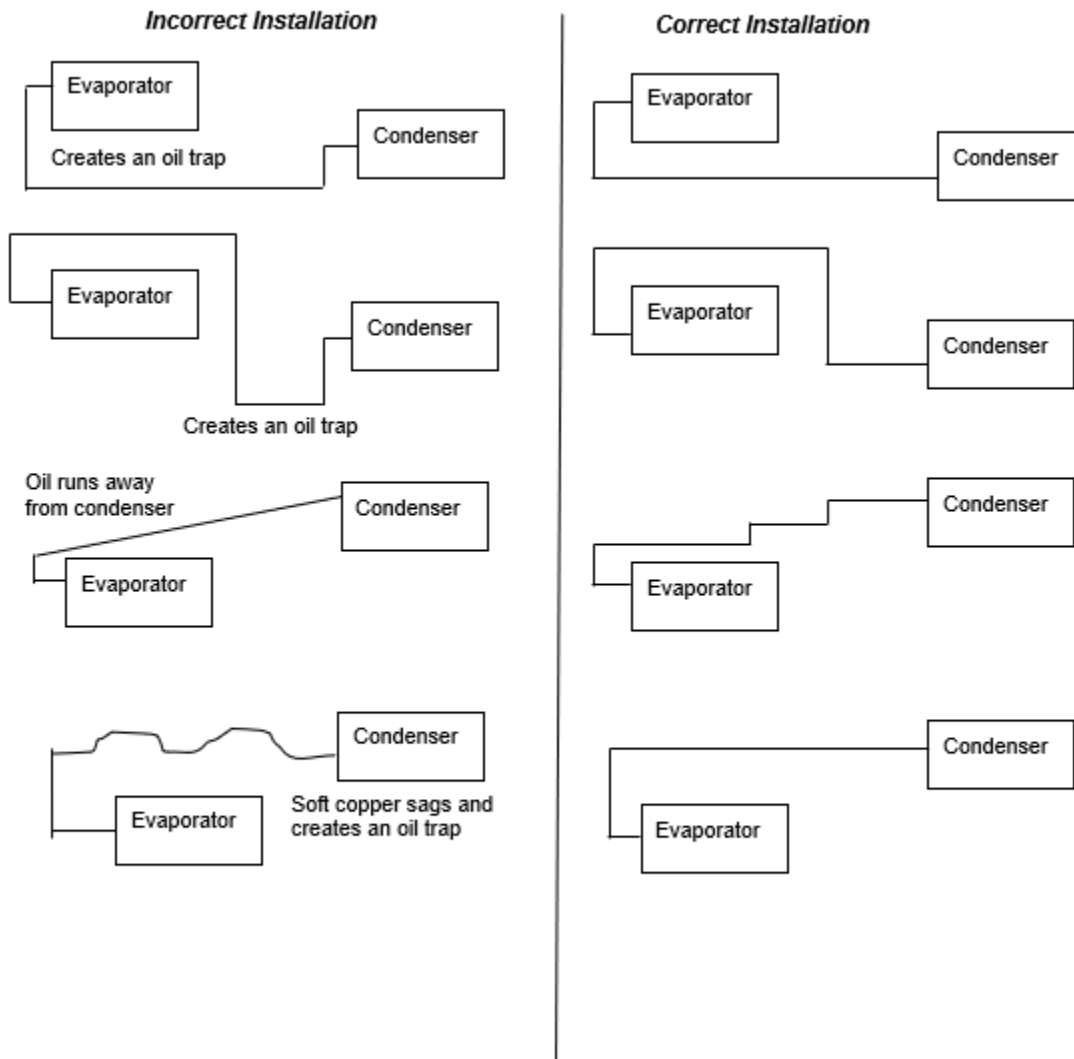

Leak Checking and Evacuation Process

- Pressurize and leak test the interconnecting lines, including the fan coil unit, fittings, and brazed joints using the intended operating refrigerant, nitrogen, or dry air for leak testing. A pressure equal to the low-side test pressure marked on the unit nameplate is recommended for leak testing. Repair any leaks found. Connect a good vacuum pump to both the low- and high-side service valves while still in their factory supplied position, isolating the refrigerant charge in the condensing unit. Draw a deep vacuum of at least 15pp microns. Do not use the motor compressor to pull a vacuum and do not operate the motor compressor in a vacuum.
- Evacuate the system to hold at 500 microns and break the vacuum by releasing the factory refrigerant charge in the condensing unit to interconnect lines and fan coil unit by opening service valves. Remove the vacuum pump. The system is now ready for

optimal charging. Refer to page 57 of this manual for correct refrigerant charging based on your interconnect length. Charge the system with the correct amount of refrigerant and mark the amount with a ballpoint pen in the space provided on the unit nameplate.

Note: When charging through the suction service valve the refrigerant should be charged in vapor form. NEVER CHARGE IN LIQUID FORM. Refrigerant should always be charged through a dryer. Charging in liquid form may damage the valve plate assembly as well as scrub the oil out of the compressor bearings.

Be sure there is not an overcharge of refrigerant. An overcharge might permit liquid refrigerant to enter the motor compressor and damage the valves, rods, pistons, etc.

Wiring the Condenser

- Wire the system as per the supplied wiring schematics starting on page 17 of this manual **OR** on the door of the condenser.
- The DS fan coil unit is powered through a factory-supplied power cord (for DS models, WGS is hard connected), but you will need to run 24-volt power wires from the low-voltage terminal block on the fan coil to the terminal block in the junction box in the condensing unit labeled Y & C. This can be typical controller wire or 18-gauge insulated wire. (See images below)

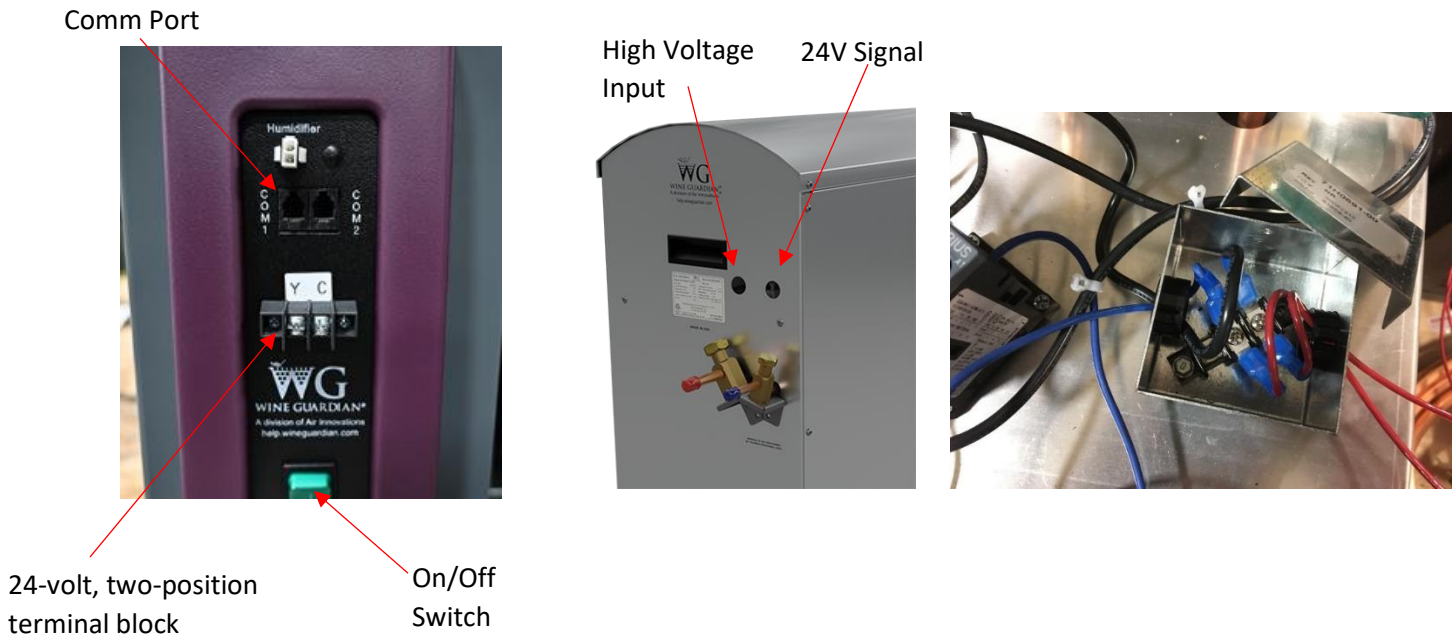

- The condensing unit needs to be hardwired. To bring the rated high voltage to the factory-installed contactor in the chassis cabinet to line side (L1 & L3) of the contactor. Use table 1 to identify the minimum recommended AWG, **USE COPPER WIRE ONLY**. Run a ground lead to be connected to the condensing unit Ground lead/LUG. There is a separate ground lug for the condensing unit internal components (See Fig 3). The load side of the factory-installed contactor will be factory-wired.
- Turn on power to the condensing unit 24 hours prior to system start-up to allow crankcase heater to warm up compressor crankcase.

Unit	Recommended Minimum AWG
DS025; WGS40	16
DS050; WGS75	16
DS088; WGS100	16
DS200; WGS175	12

Installing the Remote Interface and Communication Cable



The Wine Guardian Wireless-to-base Remote Interface Controller is a combination temperature and humidity controller with single stage cooling, heating, and humidity control. Its capacitive touch screen incorporates an on/off switch, adjustment arrows and settings buttons for ease of use and programming. The controller can be installed

one of two ways:

IMPORTANT

Whenever possible we strongly suggest wiring the Remote Interface Controller directly to the Wine Guardian unit to avoid periodic battery changes and uninterrupted service.

Wired (recommended) – wired directly to the Wine Guardian unit through an RJ-9 communication cable. 50' (15.25 m) of control cable is included with each controller with longer lengths available as an option.

IMPORTANT

Wireless installation may result in limited communication range and connectivity issues depending upon building construction and distance between Wine Guardian unit and Remote Interface Controller and/or Remote Sensors.

Wirelessly - connects wirelessly to the Wine Guardian unit by Radio Frequency connectivity through one of twelve selectable channels.

The Wine Guardian Wireless2Base Remote Interface Controller is a configurable device that can be fine-tuned through a series of individual settings. The controller incorporates eight (8) key temperature, humidity, and system alarm points. Remote alarm indication is possible through terminal point connections at our main control board.

In most applications, the remote interface controller will be mounted within the wine cellar. The remote interface controller can also be mounted directly outside the wine cellar or in any other room of the home or building. When mounted outside the wine cellar, a remote sensor kit or a second wireless remote interface must be purchased and installed within the wine cellar.

IMPORTANT

Regardless of wired or wireless connection, each Wine Guardian System can have a maximum of two (2) Remote Interface Controllers and three (3) Remote Sensors.

~WARNING~

Air movement through an unsealed opening in the wall will cause condensation damage to the controller. Use durable tape to seal the opening in the wall after applying insulation around the wire in the opening.

Additional Remote Interface

Prior to adding an additional remote interface to the system, you will have to change setting 30 on the first controller to give it a different address. Refer to page 45 for instructions on how to access the interface settings and get to Setting 30 (shown on page 50).

Controller Specification

Application	WG only, single stage cooling or heating Humidification
Programmable	No
Change over	Auto or manual, Fan ON or AUTO
Color	Black (only)
User interface	Touch screen
Auto defrost control	Yes, with Serving temp option
Connection	Communicating – RJ-9 cable
Wireless-to-base communication range	40' line of site
Wireless-to-base channels	12
Remote sensors	wired or wireless
Temperature adjustment	34 to 97 Deg F (1 to 36 Deg C)
Temperature tolerance	+/- 2 Deg F (+/- 1.1 Deg C)
Humidity adjustment	2% to 93% RH
Humidity tolerance	+/- 10% RH
System temperature diagnostics	Not Available
Alarms	High temp, low temp. High humidity, low humidity. High pressure fault. Condensate, Defrost and Communication error

Mounting the Remote Interface Controller (Wired)



Fig.1

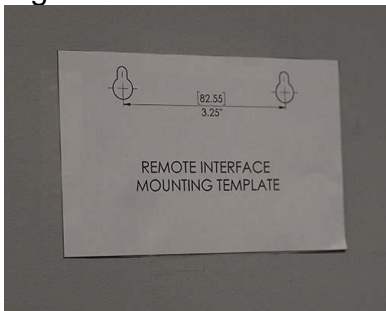

Fig. 3

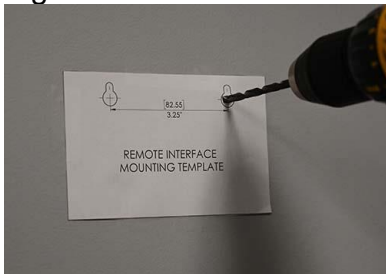

Fig. 4



Fig. 5

1. Remove the comm cable from the zip lock bag and attach it to the side of the Wine Guardian unit (Fig. 1).
 - a. Route the communication cable within the wall and/or ceiling structure of the wine cellar to the desired controller mounting location.
 - b. Plan on mounting the remote interface controller on a solid surface away from doors, corners, air outlets, drafts or heat generating equipment. Do not mount the remote interface controller directly on an outside wall, a wall adjacent to a boiler room, or other hot area. Use a piece of foam insulation behind the sensor to insulate it from a hot or cold surface. The recommended height 5ft to 6ft (1.5m to 1.8m) above the finished floor.
2. Locate the Mounting Template upon the wall where the Controller will be mounted (Fig. 2). Using the crosses on the template to assist in levelling the template.
3. Drill two 1/8" holes and insert anchors at the marked locations. Anchors may not be required if securing to a wall stud or racking system. Insert the screws into the holes and test fit the backing plate to ensure it mounts easily onto the two screws and slides down onto the slotted opening freely (Fig. 3).
4. Plug in the communication cable to the back of the remote interface controller backing plate.
 - a. If using multiple Remote Interfaces either connect each Sensor to each other in series using RJ9 cable or purchase a RJ9 Splitter to be used on the unit.
5. Attach the Controller to the wall (Fig. 4).

~WARNING~

Air movement through an unsealed opening in the wall will cause condensation damage to the controller. Use durable tape to seal the opening in the wall after applying insulation around the wire in the opening.

Note: if hardwiring a Remote Interface do NOT install any batteries in the Interface.

Mounting the Remote Interface Controller (Wireless)

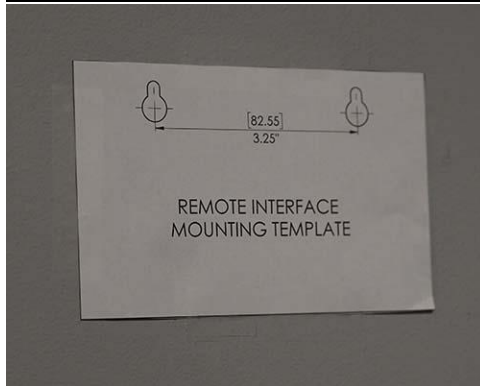

Fig. 1

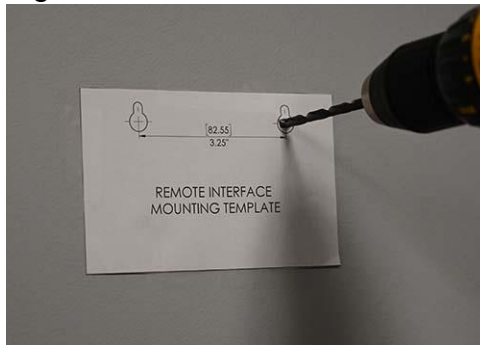

Fig. 2

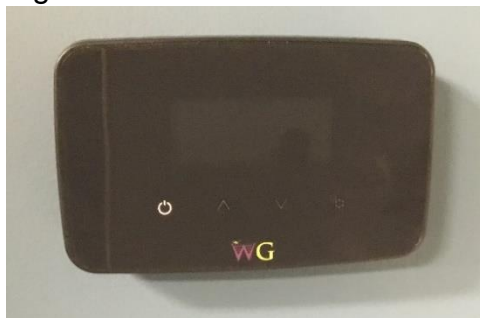

Fig. 3

1. Plan on mounting the remote interface controller on a solid surface away from doors, corners, air outlets, drafts or heat generating equipment. Do not mount the remote interface controller directly on an outside wall, a wall adjacent to a boiler room, or other hot area. Use a piece of foam insulation behind the sensor to insulate it from a hot or cold surface. The recommended height is 5ft to 6ft (1.5m to 1.8m) above the finished floor.
2. Locate the Mounting Template upon the wall where the Controller will be mounted (Fig. 1). Using the crosses on the template to assist in levelling the template.
3. Drill two 1/8" holes and insert anchors within the mounting surface. Anchors may not be required if securing to a wall stud or racking system. Insert the screws into the holes and test fit the backing plate for mounting to ensure it mounts easily onto the two screws and slides down onto the slotted openings freely (Fig. 2)
4. Insert the three AA batteries.
(Only applicable with wireless installations)
5. The system will automatically acknowledge a wireless device (Remote Interface or Remote Sensor). Go to Setting "30" to define the Remote User Interface use.
6. Attach controller to the wall (Fig. 3).

Installation of the Wine Guardian Remote Sensor



The wireless remote sensor is a combination temperature and humidity sensor only. It is designed to be mounted within the wine cellar and can be used in combination with the remote interface controller or up to two additional remote sensors to read and control multiple areas within the wine cellar.

For a wired application you will require a RJ-9 communication cable.

Mounting the Remote Sensor (Wired)



Fig. 1



Fig. 2



Fig. 3

1. Disconnect the communication cable from the side of the Wine Guardian unit and the remote sensor. Route the communication cable within the wall and/or ceiling structure of the wine cellar to the desired controller mounting location.
2. Plan on mounting the remote sensor on a solid surface away from doors, corners, air outlets, drafts or heat generating equipment. Do not mount the remote sensor directly on an outside wall, a wall adjacent to a boiler room, or other hot area. Use a piece of foam insulation behind the sensor to insulate it from a hot or cold surface. The recommended height is 5ft to 6ft (1.5m to 1.8m) above the finished floor.
3. Remove the remote sensor's face plate (Fig. 1) and mark the mounting points at the desired location within the wine cellar (Fig. 2). Also, mark the location of the communication cable connection as this area will require sufficient clearance, for the cable to exit the wall and attach to the back of the sensor.
4. Drill two 1/8" holes and insert anchors within the mounting surface. Anchors may not be required if securing to a wall stud or racking system. Insert the screws into the holes and test fit the backing plate for mounting to ensure it mounts easily onto the two screws and slides down onto the slotted openings freely. (Fig. 3)



Fig. 4

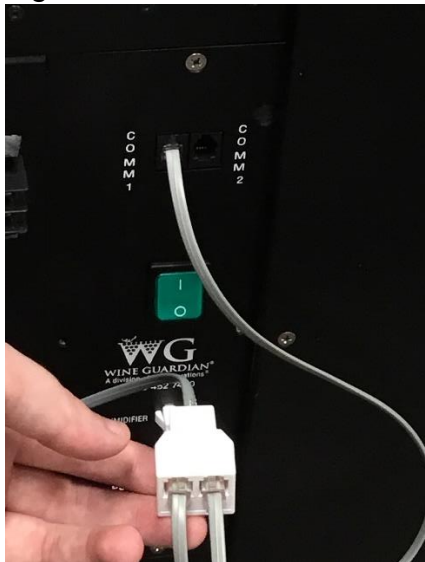

Fig. 5

5. Plug in the communication cable to the remote sensor and mount the Remote Sensor to the wall. (Fig. 3)
6. Reattach the sensor's faceplate (Fig. 4)
7. If multiple sensors are being used either connect each Sensor to each other in series using RJ9 cable or purchase a RJ9 Splitter (Fig. 5) to be connected to the unit.

Note: Remote Sensor's will always be treated as "enabled" when hardwired. Their temperature and humidity readings will always be calculated towards the average by the system.

Note: if the Remote Interface Controller will be located outside the wine room, then change setting 30 to either 3 or 4 to disable its sensors. This will help reduce the possibility of incorrect readings.

Mounting the Remote Sensor (Wireless)



Fig. 1



Fig. 2



Fig. 3



Fig. 4



Fig. 5

1. Disconnect the controller wire from the side of Wine Guardian unit and save for future use.
2. Plan on mounting the remote sensor on a solid surface away from doors, corners, air outlets, drafts or heat generating equipment. Do not mount the remote sensor directly on an outside wall, wall adjacent to a boiler room, or other hot area as this runs the risk of influencing its temperature readings. The recommended height is 5ft to 6ft (1.5m to 1.8m) above the finished floor.
3. Remove the sensor face plate (Fig. 1). Mark the mounting points at the desired location within the wine cellar (Fig. 2).
4. Drill two 1/8" holes and insert anchors within the mounting surface. Anchors may not be required if securing to a wall stud or racking system. Insert screws to secure the sensor to the wall to ensure it mounts easily onto the two screws and slides down onto the slotted openings freely.
5. Input the three AA batteries. (Fig. 3)
(Only applicable with wireless installations)
6. Pair the sensor with the unit
(See Page 44 for Pairing Instructions)

Note: Once Paired the Remote Interface's readings will be included into the system's temperature and humidity averages.

7. Mount the Remote Sensor on the wall (Fig. 4)
8. Reattach the sensor's faceplate (Fig. 5)

Remote Sensor Pairing – Multiple Sensors (Wireless)



Fig. 1



Fig. 2



Fig. 3

If using multiple remote temperature/humidity sensors in your application, refer to the figures and the procedure below to change each remote sensor's device number (Three Remote Sensors maximum). Each Remote Sensor must have its own device number and must also be on the same RF channel (Setting 31) as the system they are being paired with.





1. To change the remote sensor's device number, see the following instructions:
 - a. Use a pin to press the button for about half a second and release (Fig. 1).
 - b. Observe the LED on the side of the remote sensor (Fig. 2&3). The LED will flash once for a Device #1, twice for a #2, three times for a #3. At any time, while in this mode press the button once to change the device number. Once each remote sensor has its own unique device number simply wait for the LED to stop flashing and the setting will be saved.
2. To change the remote sensor's RF channel, see the following instructions:

Note: Check what RF Channel the System is set to using Setting 31 to connect your Remote Sensors more easily.

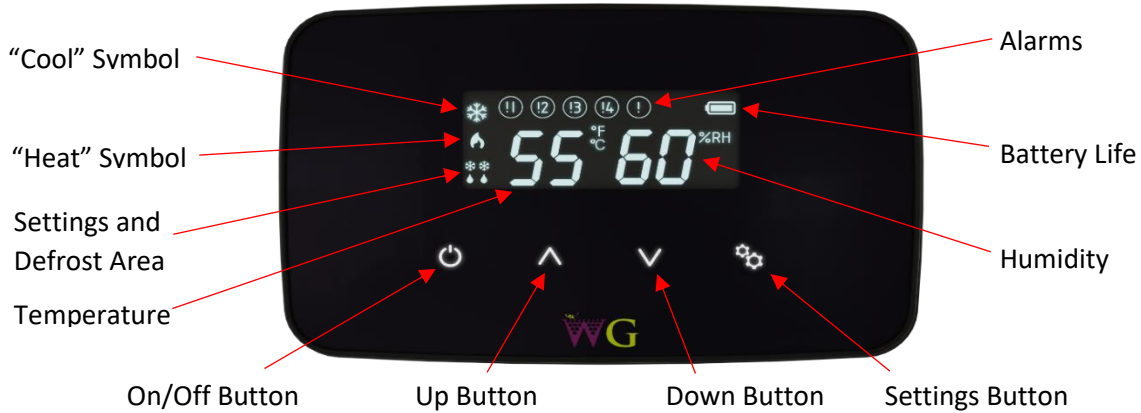
- a. Use a pin to press the red button at the back of the Remote Sensor for 5 seconds until the LED blinks rapidly then release the button.
- b. The LED will flash several times to portray which RF channel it is set to and repeat a total of 3 times.
- c. To change the RF channel, press the button once to increment the RF channel. There are 12 possible RF channels. All Remote Sensors will need to be on the same channel for the system to detect them. To save the RF channel setting simply wait for the mode to time out by not pressing the button.



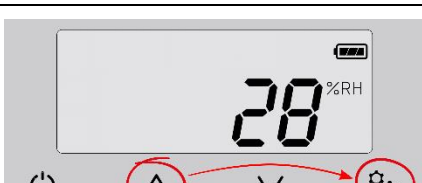



Remote Interface Functions



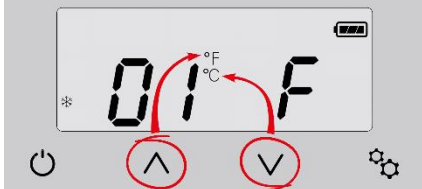



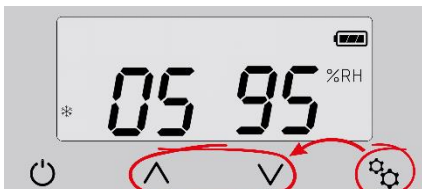

How To:		
<p>Turn system on/off</p>		<ul style="list-style-type: none"> • Press the “On/Off” button once. Note: There is a five (5) minute time delay before the system turns on or turns off.
<p>Change temperature</p>		<ul style="list-style-type: none"> • Press the “Up” arrow once. The display will show the existing temperature setpoint. • Press the up or down arrow buttons to adjust the temperature to the desired set point.
<p>Change humidity</p>		<ul style="list-style-type: none"> • Press the “Up” arrow once. This display will show the existing temperature setpoint. • Press the “Settings” button once to display the “Humidity” setpoint. • Press the “Up” or “Down” arrows to adjust the humidity to the desired set point. Note: A Wine Guardian humidifier must be installed and Setting 6 set to “1” or “2” before the controller will let you change percent humidity.
<p>Change Settings Cooling/ Heating / Auto</p>		<ul style="list-style-type: none"> • Press the Setting button once to display the setting function at the bottom of the screen. • Press the Settings button again to scroll through settings for cool only, heat only or heat/cool only (auto mode).





Settings – Press and hold the “Settings” button for five (5) seconds to access the following settings.



TAP AN ARROW KEY ONCE TO WAKE UP THE CONTROLLER



<p>Degrees F or Degrees C</p>		<p>Setting 1</p> <ul style="list-style-type: none"> • Press the “Up” arrow to change temperature from °F to °C. • Press the “Down” arrow to change temperature from °C to °F.
<p>Low temperature alarm setpoint</p>		<p>Setting 2</p> <ul style="list-style-type: none"> • Press “Settings” button to advance to Setting 2. • Press the “Up” or “Down” arrow buttons to adjust to the desired setpoint. Factory default is 50°F (10°C).
<p>High temperature alarm setpoint</p>		<p>Setting 3</p> <ul style="list-style-type: none"> • Press “Settings” button to advance to Setting 3. • Press the “Up” or “Down” arrow buttons to adjust to the desired setpoint. Factory default is 65°F (18°C).
<p>Low humidity alarm set point</p>		<p>Setting 4</p> <ul style="list-style-type: none"> • Press “Settings” button to advance to Setting 4. • Press the “Up” or “Down” arrow buttons to adjust to the desired setpoint. Factory default is 5%.
<p>High humidity alarm setpoint</p>		<p>Setting 5</p> <ul style="list-style-type: none"> • Press “Settings” button to advance to Setting 5. • Press the up or down arrow buttons to adjust to the desired setpoint. Factory default is 95%.
<p>Add or remove humidifier</p>		<p>Setting 6</p> <ul style="list-style-type: none"> • Press “Settings” button to advance to Setting 6. • Press the “Up” or “Down” arrow buttons to adjust to the desired setpoint. Factory default is zero (0). Zero (0) = No humidifier One (1) = Integral Wine Guardian mounted humidifier Two (2) = Stand-alone remote mounted humidifier

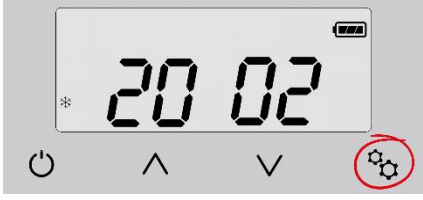

<p>Fan AUTO or ON</p>		<p>Setting 7</p> <ul style="list-style-type: none"> • Press “Settings” button to advance to Setting 7. • Press the “Up” or “Down” arrow buttons to adjust number to the desired set point. Factory default is zero (0). Zero (0) = Auto–fan only turns on when there is a call for cooling or heating One (1) = Fan On–fan remains on continuously
<p>Compressor anti-short cycling</p>		<p>Setting 8</p> <ul style="list-style-type: none"> • Press “Settings” button to advance to Setting 8. • Press the “Up” or “Down” arrow buttons to adjust to the desired time in one-minute increments. Maximum is 10 minutes; minimum is 3 minutes. Factory default is 5 minutes. <p>Compressor anti-short cycling time is the amount of allowable time between compressor stop and restart. Rapid start/stop of compressors can cause premature failure.</p> <p>WINE GUARDIAN DOES NOT RECOMMEND SETTINGS LOWER THAN FACTORY DEFAULT.</p>
<p>Defrost sensor enable/disable</p>		<p>Setting 9</p> <ul style="list-style-type: none"> • Press “Settings” button to advance to Setting 9. • Press the “Up” or “Down” arrow buttons to adjust to the desired setpoint. 1 will equal enabled and a 0 (zero) will equal disabled.
<p>Defrost cut-in temperature</p>		<p>Setting 10</p> <ul style="list-style-type: none"> • Press "Settings" button to advance to Setting 10. • Press the “Up” or “Down” arrow buttons to adjust to the desired setpoint. This setting is adjustable from 25°F to 40°F. Factory default is 39°F. There must be at least a 1°F difference between defrost cut-in and cut-out set points.

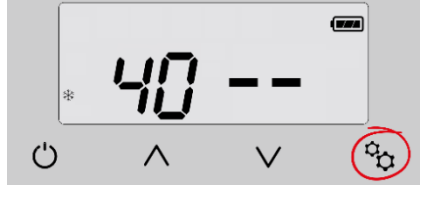
<p>Defrost cut-out temperature</p>		<p>Setting 11</p> <ul style="list-style-type: none"> • Press "Settings" button to advance to Setting 11. • Press the "Up" or "Down" arrow buttons to adjust to the desired setpoint. This setting is adjustable from 35°F to 50°F. Factory default is 40°F. <p>Note: This setpoint must be 1°F/°C higher than setting 10.</p> <p>Note: If °C is selected and then switched back to °F the default cut-out will change to 41°F.</p>
<p>Defrost check interval</p>		<p>Setting 12</p> <ul style="list-style-type: none"> • Press "Settings" button to advance to Setting 12. • Press the "Up" or "Down" arrow buttons to adjust to the desired setpoint. This setting is adjustable from 30 min at 0 (zero), 1 hour at 1, and then in 1 hour increments up to a maximum of 12 hours at 12.
<p>Room temperature offset</p>		<p>Setting 13</p> <ul style="list-style-type: none"> • Press "Settings" button to advance to Setting 13. • Press the "Up" or "Down" buttons to adjust to the desired set point. Maximum setting is +5°F, minimum setting is -5°F. Factory default is zero (0). <p>Room temperature offset changes the actual display reading (temperature only) by the value of this setting.</p> <p>Example: Sensor reading = 55°F (13°C) Setting 13 set to +4 Display reading = 59°F (15°C)</p>

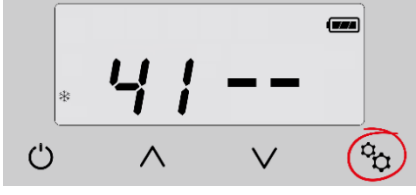
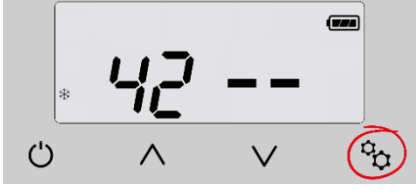
<p>RH offset</p>		<p>Setting 14</p> <ul style="list-style-type: none"> • Press “Settings” button to advance to Setting 14 • Press the “Up” or “Down” buttons to adjust to the desired setpoint. This setting allows the adjustment of %RH reading by +/-10%. Factory default is 0%RH.
<p>Differential temperature adjustment</p>		<p>Setting 15</p> <ul style="list-style-type: none"> • Press “Settings” button to advance to Setting 15 • Press the “Up” or “Down” buttons to adjust to the desired setpoint. This setting changes the system/compressor turn-on temperature above setpoint. Factory default is 1°F. <p>Example: Sensor reading = 55°F (13°C) Setting 15 set to +3°F System/compressor turns on at 58°F (14°C)</p>
<p>Temperature deadband</p>		<p>Setting 16</p> <ul style="list-style-type: none"> • Press “Settings” button to advance to Setting 16. • Press the “Up” or “Down” buttons to adjust to the desired setpoint. This setting is the minimal allowable temperature difference between heating and cooling setpoints. Maximum is 5°F (3°C), minimum is 1°F (1°C). Factory default is 2°F (1°C).
<p>Condensate switch</p>		<p>Setting 17</p> <ul style="list-style-type: none"> • Press “Settings” button to advance to Setting 17. • Press the “Up” or “Down” buttons to adjust to the desired setpoint. This setting disables or enables the Condensate switch. 0 (zero) is disabled, 1 is enabled. Factory default is 0.
<p>Reserved</p>		<p>Settings 18 & 19 Reserved for additional fields.</p>

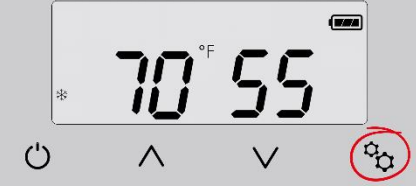
System type defaults		Setting 20 System setting. DO NOT CHANGE.
Reserved		Settings 21-29 Reserved for additional fields.
Define remote user interface		Setting 30 <ul style="list-style-type: none"> • Press “Settings” button to advance to Setting 30 • Press the “Up” or “Down” buttons to adjust to the desired setpoint. <ul style="list-style-type: none"> 1 = Remote User interface #1 mounted within the wine room space and enabled 2 = Remote User interface #2 mounted within the wine room space and enabled 3 = Remote User Interface #1 disabled will display only and can be mounted outside of wine room 4 = Remote User Interface #2 disabled will display only and can be mounted outside of wine room
RF channel select		Setting 31 <ul style="list-style-type: none"> • Press “Settings” button to advance to Setting 31. • Press the “Up” or “Down” buttons to adjust to the desired setpoint. Each system needs all devices to be on the same RF channel. <ul style="list-style-type: none"> 0 = RF disabled - system must be hardwired 1 through 12 = RF enabled and 12 channels available
Reserved		Settings 32-39 Reserved for additional fields.
Thermistor 1 <u><i>No Longer Applicable</i></u>		Setting 40 <ul style="list-style-type: none"> • Press “Settings” button to advance to Setting 40. Not Available Reserved for Thermistor

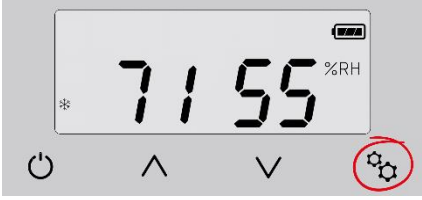
<p>Thermistor 2</p> <p><u>No Longer Applicable</u></p>		<p>Setting 41</p> <ul style="list-style-type: none"> • Press “Settings” button to advance to Setting 41. <p>Not Available Reserved for Thermistor</p>
<p>Thermistor 3</p> <p><u>No Longer Applicable</u></p>		<p>Setting 42</p> <ul style="list-style-type: none"> • Press “Settings” button to advance to Setting 42. <p>Not Available Reserved for Thermistor</p>
<p>Thermistor 4</p> <p><u>No Longer Applicable</u></p>		<p>Setting 43</p> <ul style="list-style-type: none"> • Press “Settings” button to advance to Setting 43. <p>No setting adjustment. Displays the defrost sensor temperature.</p>
<p>Reserved</p>		<p>Setting 44-49</p> <p>Reserved for additional fields.</p>
<p>Output test</p>		<p>Setting 50</p> <ul style="list-style-type: none"> • Press “Settings” button to advance to Setting 50. • Press the “Up” or “Down” buttons to adjust to the desired setpoint. <p>Steps through relays as output test. 0 = Disabled 1 = Enabled</p>
<p>Reserved</p>		<p>Setting 51-69</p> <p>Reserved for additional fields.</p>
<p>Default temperature</p>		<p>Setting 70</p> <ul style="list-style-type: none"> • Press “Settings” button to advance to Setting 70. <p>No setting adjustment. Initial temperature set point. Will revert to this setting upon loss of power.</p>

<p>Default %RH</p>		<p>Setting 71</p> <ul style="list-style-type: none"> Press “Settings” button to advance to Setting 71. <p>No setting adjustment.</p> <p>Initial relative humidity set point. Will revert to this setting upon loss of power.</p>
<p>Default mode</p>		<p>Setting 72</p> <ul style="list-style-type: none"> Press “Settings” button to advance to Setting 72. Press the “Up” or “Down” buttons to adjust to the desired setpoint. <p>Initial mode set point. Will revert to this setting upon loss of power.</p> <p>1 = Auto 2 = Cool 3 = Heat</p>

Alarm Codes

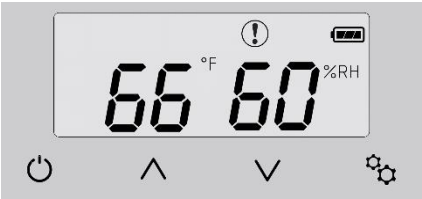
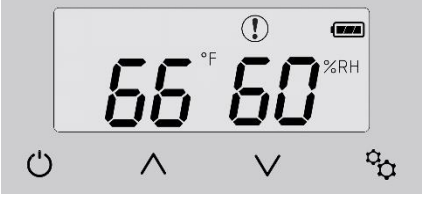
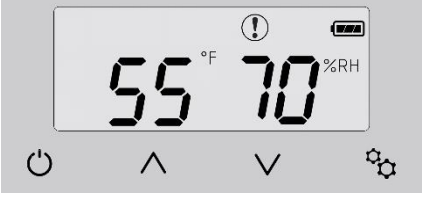
<p>High temperature alarm</p> <p>Flashing temperature number</p>		<p>Flashing temperature number along with (!) symbol will remain on screen until temperature falls below the High Temperature Alarm set point (Setting 3).</p>
<p>Low temperature alarm</p> <p>Flashing temperature number</p>		<p>Flashing temperature number along with (!) symbol will remain on screen until temperature rises above the Low Temperature Alarm set point (Setting 2).</p>
<p>High humidity alarm</p> <p>Flashing humidity number</p>		<p>Flashing humidity number along with (!) symbol will remain on screen until humidity falls below the High Humidity Alarm setpoint (Setting 5).</p>

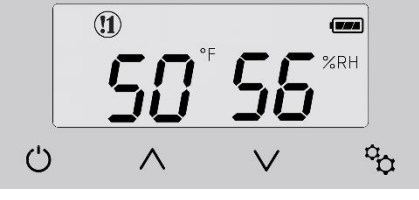
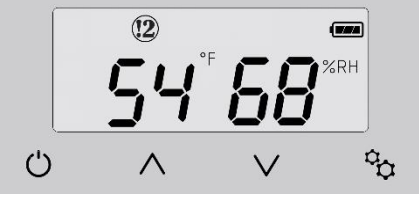
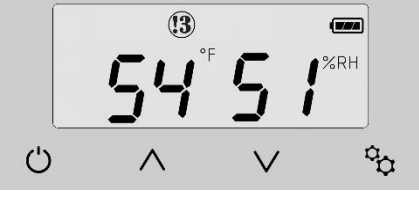
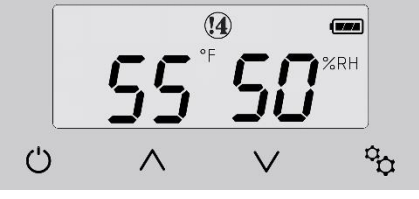
<p>Low humidity alarm</p> <p>Flashing humidity number</p>		<p>Flashing humidity number along with (!) symbol will remain on screen until humidity rises above the Low Humidity Alarm set point (Setting 4).</p>
<p>!1 = High Pressure Switch Fault</p>		<p>THIS ALARM FORCES THE SYSTEM TO SHUT DOWN</p> <p>(!1) will remain on screen until the High Pressure reset switch has been reset. See the trouble shooting guide page 67 for “Instructions to Reset High Pressure Switch”.</p>
<p>!2 = CS (Condensate Switch Fault)</p>		<p>THIS ALARM FORCES THE SYSTEM TO SHUT DOWN</p> <p>(!2) will remain on screen until the CS (condensate switch) fault is resolved and reset.</p>
<p>!3 = Defrost Sensor Fault</p>		<p>THIS ALARM FORCES THE SYSTEM TO SHUT DOWN</p> <p>Defrost sensor has been shorted, disconnected or open. (!3) will remain on screen until the defrost sensor issue has been resolved.</p>
<p>!4 = Communication loss</p>		<p>THE SYSTEM REMAINS OPERATIONAL DURING THIS ALARM</p> <p>Bad or no data transfer between sensing device and main control board. “!4” will remain on screen until communication is re-established.</p>

! WARNING !

If multiple units are installed close to each other, make sure the radio is turned off (setting 31)

Start-Up

Prior to charging the system and start-up ensure the system has been powered for at least **24 hours**. This is required so the compressor's crankcase heater has ample time to warm the system to avoid premature failure. Then proceed to charging the system.

Refrigerant Charging

Note: Models DS, and WGS utilize a Headmaster control valve to control head pressure at low ambient applications, therefore require a specific initial charging procedure as outlined below.

Determining the amount of charge (Low Ambient and Extreme Climate Protection) - When "refrigerant side" head pressure control is utilized on a system, one of the most important factors is determining the total system refrigerant charge. While on most packaged units the amount of charge is listed on the unit, the required charge for a field built-up system cannot be listed by the manufacturer. Charge is usually added when the system is started up until "proper" system performance is reached. However, this is not satisfactory and if the system is to function properly year-round, the correct amount of extra charge must be calculated ahead of time.

Charging System with Head Pressure Control

Note: When charging any system with head pressure control the outdoor ambient temperature must be known.

Charging of Systems with Head Pressure Control in temperatures **above** 70°F (21°C) (After normal evacuation procedures):

1. Connect refrigerant cylinder to liquid line service valve port.
2. Charge liquid refrigerant into the high side of the system. Weighing the charge is recommended.
3. Remove the refrigerant drum and connect it to the suction service valve.
4. Charge refrigerant vapor into the low side. Do not allow liquid refrigerant into the low side.
5. Start the system.
6. Observe sight glass (factory-installed) to see if system is filling with refrigerant for normal refrigeration cycle.
7. If the Sight glass shows bubbles, more refrigerant may be required, while allowing sufficient time for the refrigerant to stabilize and clear the Sight glass. Use supplied information on the following pages for proper final charge.

BUBBLES IN THE SIGHT GLASS CAN BE CAUSED BY FLASHING DUE TO PRESSURE DROP FROM PIPE OR ACCESSORY LOSSES, ETC.

Charging of Systems with Head Pressure Control in temperatures ***below*** 70°F (21°C)
(After normal evacuation procedures):

1. You must power the condensing unit for up to 24hrs prior to charging the system to allow the system to energize. This will allow the compressor's oil crankcase to warm. If not done hours in advance of the system/compressor start-up, there is risk of premature compressor failure, which would not be covered under warranty.
2. Follow instructions 1 through 7 above.
3. If the valve setting is correct for the system being charged, it is quite likely some refrigerant will be backed up into the condenser and the Sight glass will indicate bubbles in the liquid line.
4. Add more refrigerant, while allowing sufficient time for the refrigerant to stabilize and clear the Sight glass. Use supplied information on the following pages for proper final charge.
5. At this point the system is correctly charged for this type of head pressure control at the ambient temperature that exists while the charging procedure is taking place.
6. If the system is designed to operate at ambient below the ambient that exists during charging, additional charge may have to be added now.

Good system performance during low ambient operation depends on proper refrigerant charge; therefore, it is very important that this phase of the installation procedure be done carefully. Poor system performance is often caused by over- or under-charging of refrigerant and may be the most overlooked.

With the system started

- After following instructions on the previous page Charging for Systems with Head Pressure Control, with refrigerant tank now connected to suction line (low side) port to add remaining charge in a gas state, refer to the provided charts for proper system operating points as equated to ambient temperature with wine cellar at normal conditions of 57°F (13°C) / 55%RH. Refer to Split Systems Operations chart on page 58 for system pressures, subcooling, and superheat values to allow you to charge your system correctly.
- In addition to using the Systems Operations Chart, there is a liquid line moisture/sight glass located in the condensing (outdoor) unit as a useful guide to help determine if the system has been sufficiently charged. HOWEVER, a full sight glass or a glass with bubbles does not necessarily indicate the system is properly charged or undercharged. There may be other factors affecting sight glass, so do not charge by sight glass method only. A full sight glass matched with proper system pressures, subcooling, and superheat values is the proper method for confirming that the system charge is correct for your application.

If you are not sure how to measure superheat or sub-cooling:

Superheat

- Get an accurate suction line temperature on the suction line as close to the compressor inlet as possible. At the same time, attach a compound pressure gauge set to the system to read the low-side suction pressure at the suction service valve port (back seated valve stem to allow unrestricted refrigerant flow from evaporator back to the compressor). Convert suction pressure to a saturated temperature as derived from a pressure/temperature chart. Since the suction line temperature is the higher value, subtract the saturated temperature from it to derive your superheat. If your wine cellar is already at specified conditions e.g., 57°F (13°C), 55% RH) and if your superheat is very low, or zero, you may have overcharged your system.

Sub-Cooling

- With your compound pressure gauge set installed with the high-side connect to the valve port on the liquid receiver (back seated valve stem to allow unrestricted refrigerant flow from condenser to evaporator). Convert this liquid pressure to a saturated temperature from pressure/temperature chart. Next, obtain your liquid-line temperature by getting an accurate reading on the liquid line BEFORE the TXV expansion on the indoor side. Obtain this temperature entering the evaporator unit. Subtract the liquid line temperature from the saturated liquid temperature to derive the system sub-cooling.

Charge Amount:

For Installations using a line-set distance that are **Less Than or Equal To** 25' add the required amount of refrigerant shown in the table on the next page.

For Installations using a line-set distance that are **Greater Than** 25' add the required amount of refrigerant shown in the table on the next page THEN add additional refrigerant based on the rules below:

Models SS018, CS025, DS025, CS050, DS050, WGS25, WGC60, WGS40, WGS75

Add an additional 0.50 oz/ft (0.465 kg/meter) for every foot **exceeding** 25'

Models DS088, DS200, WGS100, and WGS175

Add an additional 1 oz/ft (0.93 kg/meter) for every foot **exceeding** 25'

Assuming a 25' Line-Set Installation				
Model #	Total Charge Required	Holding Charge Present	<u>Charge That Must Be Added</u>	<u>Additional Charge to add for XLA¹ option</u>
<i>60Hz Models</i>				
SS018	47 oz	16 oz	31 oz	4 oz
CS025	58 oz	16 oz	42 oz	4 oz
DS025	59 oz	16 oz	43 oz	4 oz
CS050	66 oz	16 oz	50 oz	4 oz
DS050	55 oz	16 oz	39 oz	4 oz
DS088	105 oz	16 oz	89 oz	6 oz
DS200	108 oz	16 oz	92 oz	6 oz
<i>50Hz Models</i>				
WGS25	50 oz	16 oz	34 oz	4 oz
WGC60	64 oz	16 oz	48 oz	4 oz
WGS40	58 oz	16 oz	42 oz	4 oz
WGS75	64 oz	16 oz	48 oz	4 oz
WGS100	106 oz	16 oz	90 oz	6 oz
WGS175	110 oz	16 oz	94 oz	6 oz

¹XLA – Extreme Low Ambient Option

Once the system has been charged, compare the high side system pressure to the “discharge line pressure” found below in the “Split System Operations Chart” for proper operation. If actual discharge pressures do not match the chart, then compare subcooling values as additional charge may be needed.

Split System Operations Chart

Operation data is based on typical wine cellar conditions
57°F (14 Deg C) DB/49°F WB (55%RH)

60Hz Models				
DS025				
OD Ambient (F)	Suction (psig)	Discharge (psig)	Suction Superheat (F)	Sub-cooling (F)
10 °F / -12 °C	21	100	7 °F / 3.89 °C	23 °F / 12.78 °C
40 °F / 4 °C	24	104	13 °F / 7.22 °C	24 °F / 13.33 °C
60 °F / 15 °C	24	107	22 °F / 12.22 °C	20 °F / 11.11 °C
70 °F / 21 °C	24	108	25 °F / 13.89 °C	18 °F / 10 °C
80 °F / 26 °C	24	108	31 °F / 17.221 °C	16 °F / 8.89 °C
100 °F / 37 °C	27	150	38 °F / 21.11 °C	19 °F / 10.56 °C
115 °F / 46 °C	30	190	40 °F / 22.22 °C	21 °F / 11.67 °C
DS050				
OD Ambient (F)	Suction (psig)	Discharge (psig)	Suction Superheat (F)	Sub-cooling (F)
20 °F / -6 °C	22	96	15 °F / 8.33 °C	9 °F / 5 °C
30 °F / -1 °C	24	100	13 °F / 7.22 °C	10 °F / 5.56 °C
50 °F / 10 °C	26	102	16 °F / 8.89 °C	19 °F / 10.56 °C
60 °F / 15 °C	24	100	21 °F / 11.67 °C	16 °F / 8.89 °C
70 °F / 21 °C	26	98	23 °F / 12.78 °C	13 °F / 7.22 °C
80 °F / 26 °C	27	114	26 °F / 14.44 °C	15 °F / 8.33 °C
100 °F / 37 °C	28	160	32 °F / 17.78 °C	16 °F / 8.89 °C
115 °F / 46 °C	32	208	34 °F / 18.89 °C	18 °F / 10 °C
DS088				
OD Ambient (F)	Suction (psig)	Discharge (psig)	Suction Superheat (F)	Sub-cooling (F)
25 °F / -4 °C	23	98	8 °F / 4.44 °C	17 °F / 9.44 °C
40 °F / 4 °C	24	98	13 °F / 7.22 °C	18 °F / 10 °C
60 °F / 15 °C	24	98	22 °F / 12.22 °C	16 °F / 8.89 °C
70 °F / 21 °C	24	104	24 °F / 13.33 °C	10 °F / 5.56 °C
80 °F / 26 °C	24	130	30 °F / 16.67 °C	15 °F / 8.33 °C
100 °F / 37 °C	26	185	38 °F / 21.11 °C	19 °F / 10.56 °C
115 °F / 46 °C	28	235	31 °F / 17.22 °C	21 °F / 11.67 °C
DS200				
OD Ambient (F)	Suction (psig)	Discharge (psig)	Suction Superheat (F)	Sub-cooling (F)
30 °F / -1 °C	21	100	13 °F / 7.22 °C	3 °F / 1.67 °C
40 °F / 4 °C	21	100	12 °F / 6.67 °C	3 °F / 1.67 °C
60 °F / 15 °C	22	110	14 °F / 7.78 °C	4 °F / 2.22 °C
70 °F / 21 °C	22	132	16 °F / 8.89 °C	5 °F / 2.78 °C
80 °F / 26 °C	23	160	18 °F / 10 °C	6 °F / 3.33 °C
100 °F / 37 °C	23	213	20 °F / 11.11 °C	7 °F / 3.89 °C
115 °F / 46 °C	25	240	24 °F / 13.33 °C	3 °F / 1.67 °C

50Hz Models				
WGS40				
OD Ambient (F)	Suction (psig)	Discharge (psig)	Suction Superheat (F)	Sub-cooling (F)
10 °F / -12 °C	23	95	6 °F / 3.33 °C	17 °F / 9.44 °C
40 °F / 4 °C	26	102	12 °F / 6.67 °C	26 °F / 14.44 °C
60 °F / 15 °C	28	105	19 °F / 10.55 °C	20 °F / 11.11 °C
70 °F / 21 °C	28	107	22 °F / 12.22 °C	18 °F / 10 °C
80 °F / 26 °C	28	106	27 °F / 15 °C	15 °F / 8.33 °C
100 °F / 37 °C	30	144	36 °F / 20 °C	16 °F / 8.89 °C
115 °F / 46 °C	32	180	37 °F / 20.56 °C	20 °F / 11.11 °C
WGS75				
OD Ambient (F)	Suction (psig)	Discharge (psig)	Suction Superheat (F)	Sub-cooling (F)
20 °F / -6 °C	26	96	6 °F / 3.33 °C	23 °F / 12.78 °C
30 °F / -1 °C	26	97	10 °F / 5.56 °C	23 °F / 12.78 °C
40 °F / 4 °C	26	97	13 °F / 7.22 °C	21 °F / 11.67 °C
60 °F / 15 °C	26	96	20 °F / 11.11 °C	15 °F / 8.33 °C
70 °F / 21 °C	26	98	27 °F / 15 °C	11 °F / 6.11 °C
80 °F / 26 °C	28	116	28 °F / 15.56 °C	12 °F / 6.67 °C
100 °F / 37 °C	30	167	35 °F / 19.44 °C	14 °F / 7.78 °C
WGS100				
OD Ambient (F)	Suction (psig)	Discharge (psig)	Suction Superheat (F)	Sub-cooling (F)
20 °F / -6 °C	25	100	11 °F / 6.11 °C	11 °F / 6.11 °C
40 °F / 4 °C	26	101	14 °F / 7.78 °C	17 °F / 9.44 °C
60 °F / 15 °C	26	98	18 °F / 10 °C	14 °F / 7.78 °C
70 °F / 21 °C	26	100	20 °F / 11.11 °C	10 °F / 5.56 °C
80 °F / 26 °C	28	125	22 °F / 12.22 °C	9 °F / 5 °C
100 °F / 37 °C	30	175	25 °F / 13.89 °C	8 °F / 4.44 °C
115 °F / 46 °C	29	217	32 °F / 17.78 °C	17 °F / 9.44 °C
WGS175				
OD Ambient (F)	Suction (psig)	Discharge (psig)	Suction Superheat (F)	Sub-cooling (F)
20 °F / -6 °C	22	96	15 °F / 8.33 °C	42 °F / 23.33 °C
40 °F / 4 °C	22	96	15 °F / 8.33 °C	39 °F / 21.67 °C
60 °F / 15 °C	22	107	21 °F / 11.67 °C	24 °F / 13.33 °C
70 °F / 21 °C	23	125	19 °F / 10.56 °C	24 °F / 13.33 °C
80 °F / 26 °C	23	146	22 °F / 12.22 °C	26 °F / 14.44 °C
100 °F / 37 °C	24	188	22 °F / 12.22 °C	27 °F / 15 °C
115 °F / 46 °C	27	233	22 °F / 12.22 °C	28 °F / 15.56 °C

Final Start-up

Once the system has been adequately charged, disconnect power, double check the electrical and the ductwork, finally reconnect power and start the unit.

- Once the impeller is running, check the ducts and ductwork connections for any air leaks.
- Balance Air Distribution.
- Confirm condenser airflow is unrestricted.
- Check for excessive noise or vibration.

Once the system is confirmed to be running, introduce an independent thermostat into the wine room near the return grille and compare it to the readings of the remote interface and ensure the interface is reading correctly. If the interface requires calibration see page 48 for Setting 13.

During the initial start-up, the unit may run continuously for several hours, up to a day or more, while it lowers the cellar temperature. Once the unit reaches the set point temperature, it shuts off and starts to cycle on and off as it continues to lower the bottle temperature to the set point. The cellar air reaches the set point before the bottles. If the cellar temperature started at 75 °F (24 °C), the supply air temperature discharged from the unit will probably be 15 °F to 20 °F (-4 to -7 °C) colder. As the cellar temperature decreases to 55 °F (13 °C), the supply temperature differential decreases 8 to 12 °F (4.4 to 6.7°C) colder.

To decrease the run-time of the unit it is recommended to use a step down process. For example, if you are aiming to hit a 55 degrees F setpoint then you would set an initial set point of 63 degrees F. Once the system has reached 63 degrees F change the set point to 60 degrees F, then 55 degrees F. Drop the setpoint in increments, so the system has time to cycle instead of running continuously to reach the preferred set point.

Please note that the Remote Interface Controller will display a “High Temperature” alarm until the wine room’s temperature falls below the set point. Please see the *Alarm Codes* section of the manual.

COMPLETE YOUR START-UP CHECKLIST

FOUND ON THE NEXT PAGE



WG SPLIT SYSTEM START-UP CHECKLIST

System Information

Fan Coil Serial Number: (Located to the right of the main control panel)	Condenser Serial Number: (Label located near refrigerant piping)
---	---

Customer Information

First Name:		Last Name:	
Address:		City:	
State:	Zip:	Date of Purchase:	
Email:		Phone #:	

Installer Information

Company Name:		License#	Date of Startup:
Address		Technician:	
City		Certification ID Number	
State:	Zip:	Certification Source (e.g. NATE):	
Company Phone #:		Technician Phone #:	
Company Email:		Technician Email:	

Email completed form to service@wineguardian.com

Pre-Start-Up		
Is there any shipping damage? If so, Where?		
Will this damage prevent unit start-up?		
Check power supply. Does it agree with unit?		
Has the ground wire been connected?		
Has the circuit protection been sized and installed properly?		
Are the power wires to the unit sized and installed properly?		
Have compressor hold down bolts been loosened (snubber washers are snug, but not tight)?		
Controls		
Are thermostat and indoor fan control wiring connections made and checked?		
Are all wiring terminals (including main power supply) tight?		
Has crankcase heater been energized for 24 hours?		
Indoor Unit		
Has water been placed in drain pan to confirm proper drainage?		
Piping		
Have leaks checks been made at compressor, outdoor and indoor coils, TXVs (Thermostatic Expansion Valves), Filter Driers, with a leak detector?		
Locate, Repair, and Report any leaks.		
Have service valves been opened?		
Check Voltage	L1:	L3:
Start-up		
After at least 10 minutes running time, record the following measurements		
Suction Pressure:		
Suction line temperature:		
Discharge pressure:		
Discharge line temperature:		
Entering outdoor unit air temperature:		
Leaving outdoor unit air temperature:		
Indoor unit enter-air DB (dry bulb) temperature:		
Indoor unit leaving-air WB (wet bulb) temperature:		
Indoor unit leaving-air DB (dry bulb) temperature:		
Indoor unit leaving-air WB (wet bulb) temperature:		
Compressor Amps		

Maintenance



High Voltage

Risk of Serious Injury or Death

Use Lockout/Tagout Procedure before opening panels

Sharp Edges

Risk of Serious Injury

Sharp Edges are present on the fan wheels, housing, fins, and coils

Maintenance on Wine Guardian units requires working with high voltage and sheet metal with possible sharp edges. Only qualified personnel should perform maintenance. Some tasks require knowledge of mechanical and electrical methods. Make sure you are familiar with all hazards, general safety related procedures, and safety labels on the unit.

Standing water in drain pans promotes microbial growth (mold), which can cause unpleasant odors and serious health-related indoor air quality problems. If mold is found, remove it immediately and sanitize that portion of the unit.

The Wine Guardian system is designed for minimal maintenance. The refrigerant system is hermetically sealed and requires no maintenance. The fans are permanently lubricated and require no maintenance. Some maintenance to the unit may be required due to dust or dirt in the air stream.

The condenser coil is provided with a reusable, washable air filter. The filter protects the coil from becoming coated or plugged by dust. Frequency of cleaning the filters is based on the amount of dust or dirt generated in the cellar or basement.

1. Remove the duct collar on the inlet end of the unit. (Optional)
2. Remove the filter covering the face the coil.
3. Wash it under warm water.
4. Shake off excess water.
5. Inspect and clean the face of the coil. **Sharp edges are present on the fins and coils.**
6. Reinstall the filter.
7. Replace the duct collar.

The condensate drain system traps dust and dirt. Clean the drain system once a year.

1. Shut off the rocker switch and unplug the unit.
2. Remove the grille or duct on the evaporator inlet.
3. Remove the filter and inspect the drain pan under the coil.
4. If drain pan appears soiled, pour some hot water mixed with liquid bleach (diluted solution) along the length of the pan to flush the dirt down the drain tube. Continue this treatment until the drain appears clean and free of dirt.
5. Reinstall filter and grille/duct collar.
6. Plug in the unit and restart.

Cleaning the Humidifier (Optional)

If the unit was furnished with a humidifier, it requires periodic maintenance. Follow the instructions in the humidifier guide.

All Wine Temperatures (AWT)

The heating coil is located between the evaporator coil and blower inside the transition duct. It contains the heating element and high-temperature-limit switches. The heating coil is wired to work in conjunction with the thermostat. Since the thermostat prevents the heating and cooling circuits from being energized at the same time, no additional power wiring is needed. We do recommend using the AUTO mode on the thermostat so it can switch from heating to cooling automatically. If using either the heat only or cool only mode, the thermostat will not switch automatically.

No additional maintenance is required for the heating coil. To test the heating coil operation, set the thermostat on HEAT and set the temperature above the cellar temperature. The supply air temperature should rise above the return air temperature by an amount shown in the specifications.

Extreme Climate Protection

The purpose of the Extreme Climate Protection is to protect the compressor and refrigerant system. It has two distinct components, a crankcase heater to keep the oil in the compressor warm and to prevent slugging on system start-up and a head pressure control to cycle the condenser fan on and off automatically to maintain system head pressure.

To confirm the system is working, feel the bottom of the heater when the compressor unit has cycled off. When the unit starts, the condenser fan does not start at the same time as the compressor. The condenser fan starts after the head pressure has built up. As the unit is running the condenser fan cycles off and on while it holds the head pressure within a fixed range. The amount of cycling (frequency and duration) depends on the air temperature. The colder the air, the more frequent the cycling and with a longer duration.

Maintenance Schedule

Monthly

(or quarterly depending on experience with cellar)

- Check filter and drain trap – clean if needed.
- Check for noise or vibration.
- Check for short-cycling of the unit – a turning on and off of the compressor unit more than eight times/hour.

Yearly

(in addition to monthly)

- Replace filters if worn or plugged beyond cleaning.
- Check evaporator and condenser coils for dirt – use a vacuum with a brush attachment to clean the coils.
- Clean the condensate pan under the evaporator coil by flushing. Be careful to keep the drains pans clear of all debris.
- Inspect cabinet for corrosion or rusting – clean and paint.
- Inspect for dirt buildup on or inside the unit. Clean unit by vacuuming or wiping it down.
- Check for loose insulation, fasteners, gaskets, or connections.
- Check the wiring connections and integrity of cords.
- Examine ducts for any cracks or breach.
- Check fan and solenoid on humidifier.
- Replace humidifier drip pad (if applicable).

Troubleshooting



Before proceeding, read and understand the safety information contained in the Safety Section of the Wine Guardian Manual

For in-depth Troubleshooting please head to

Help.wineguardian.com

Resetting the High-Pressure Switch

High-Pressure Switch Has Shut Down the Unit	
Every Wine Guardian unit has a manual reset high-pressure switch in the refrigeration system. This switch shuts the compressor and condenser down if the head pressure in the system is too high. It is intended to protect the compressor. Restricted airflow through the condenser is the most common reason for the pressure to become too high. This can be caused by dust covering the filter or an obstruction blocking the airflow in the duct or grille.	
Possible Cause	Solution
Head Pressure in unit is too high because an obstruction is restricting airflow	Remove the obstruction in the duct/grille or clean the filter. Then restart the unit after resetting the high-pressure switch.

1. Remove the access panel, grille, or duct collar on the condenser to gain access to the High-Pressure Switch.
2. Locate the High-Pressure Switch near the compressor (Fig. 1).
3. Push the button until it locks into position.
4. Push the rocker switch to restart the unit.



Fig. 1

Please see the link below for a video on how to reset the High-Pressure Switch
<https://www.youtube.com/watch?v=TFGFTWZVeAs>

Contact and Warranty

GENERAL

Wine Guardian warrants, to the original buyer, its goods, and all parts thereof to be free from defects in material and workmanship for a period of two (2) years from the date of invoicing assuming NORMAL USE AND SERVICE.

LIABILITY

Wine Guardian liability shall be limited to the repair or replacement (at its option) of any part, which, at our sole discretion, is determined to be defective. The purchaser shall pay all transportation costs. Additionally, if a malfunction occurs within the first year from the date of invoice, Wine Guardian will reimburse the reasonable cost of labor required for the repair or replacement provided authorization is obtained from one of our authorized representatives prior to incurring any labor charges.

LIMITATIONS OF LIABILITY

THESE WARRANTIES ARE MADE IN LIEU OF ALL OTHER WARRANTIES EXPRESSED OR IMPLIED, INCLUDING ANY IMPLIED WARRANTY OF MERCHANTABILITY OR FITNESS FOR A PARTICULAR PURPOSE AND IN LIEU OF ANY OTHER OBLIGATION OR LIABILITY, INCLUDING LIABILITY FOR ANY INCIDENTAL OR CONSEQUENTIAL DAMAGES. Wine Guardian will not be responsible for any costs or liabilities whatsoever resulting from improper installation or service of its equipment. In the event that Wine Guardian or its distributors are found liable for damage based on any defect or nonconformity in the products, their total liability for each defective product shall not exceed the purchase price of such defective products. No person or representative is authorized to change these warranties or assume any other obligations or liabilities for Wine Guardian in connection with the sale of its systems.

INDEMNIFICATION

Purchaser agrees to indemnify, hold harmless and defend seller and its officers, directors, agents, and employees from and against any and all claims, liabilities, costs and expenses arising out of or related to Purchaser's use of the goods, or in any way involving injury to person or property or accident occasioned by the goods sold by Wine Guardian to Purchaser.

FOREIGN GOVERNMENT AND INDIAN NATIONS

If Purchaser is a foreign government or an Indian nation, Purchaser hereby expressly waives its defense of sovereign immunity in the event of a dispute between Purchaser and Wine Guardian regarding this invoice and Purchaser expressly acquiesces to the jurisdiction of the federal and state courts of the United States.

SEVERABILITY

If one or more of the provisions contained in this contract shall for any reason be held to be invalid, illegal, or unenforceable in any respect, such invalidity, illegality, or unenforceability shall not affect any provision of this contract, but this contract shall be

construed as if such invalid, illegal or unenforceable provision had never been contained.

ADDITIONAL REQUIREMENTS

If a defect covered by the Warranty occurs, contact Wine Guardian for authorization to proceed with corrective action. Do not return any parts or incur any charges for which you expect to be reimbursed under this Warranty without receiving this authorization. If parts are replaced under this Warranty, the defective parts must be returned prepaid within 30 days. This warranty shall be null and void in its entirety if the Serial Number on the air conditioner or compressor is altered, removed, or defaced.

Contact Information

Wine Guardian
7000 Performance Drive
North Syracuse, NY, 13212

Web sites: wineguardian.com

Help.wineguardian.com

Email: info@wineguardian.com

Warranty

The Wine Guardian unit serial number is noted on all packing lists and bills of lading and, along with shipping date, is kept on file at Wine Guardian for warranty purposes.

All correspondence regarding warranty must include the model number and serial number of the unit involved. **Note:** that the warranty is null and void if the serial number on the unit or compressor is altered, removed, or defaced. All Inquiries or correspondence regarding warranty should be handled in accordance with the "Warranty" and directed to:

Wine Guardian
7000 Performance Drive
North Syracuse, New York, 13212
Attn: Service Department

This procedure includes but is not limited to

Obtaining authorization from Wine Guardian prior to incurring any charges for repair or replacement under warranty.

Or returning prepaid within 30 days any and all defective parts.