



# SIRAS™ Standard Bundle User Manual

**102-2069-40**

**Revision 12**

January 30, 2023

Thank you for purchasing the SIRAS Standard Bundle. This user manual provides information regarding SIRAS features and controls. SIRAS is a professional drone product intended to be operated exclusively by USA FAA Part 107 certified pilots with current certification and by pilots holding equivalent certifications from the USA FAA. There are many aspects to operating this aircraft not covered in this manual - aspects that are known to certified pilots who are aware of and follow all local, state, and federal laws and regulations regarding the operation of commercial unmanned aerial systems. Please read this manual in its entirety and follow all guidance. Find additional information and updates at [www.flir.com/siras](http://www.flir.com/siras).

In the United States, drones are registered on the Federal Aviation Administration website:  
[https://www.faa.gov/licenses\\_certificates/aircraft\\_certification/aircraft\\_registry/ua](https://www.faa.gov/licenses_certificates/aircraft_certification/aircraft_registry/ua).

# TABLE OF CONTENTS

1. SIRAS DOCUMENTATION .....	7
2. SIRAS STANDARD BUNDLE / SPECIFICATIONS .....	7
3. SIRAS AIRCRAFT .....	10
4. SIRAS CONTROLLER .....	11
A. Controller Layout .....	11
B. Controller LED Definitions and Functions .....	13
C. Controller Battery Charging .....	14
D. Controller MicroSD Card .....	14
E. Controller Antenna .....	15
5. AIRCRAFT BATTERY SAFETY / CHARGING .....	16
A. Aircraft Battery Safety .....	16
B. Aircraft Battery Charging Instructions .....	17
C. Aircraft Battery Charger Performance as a Function of Temperature .....	19
6. REPAIRING THE SIRAS AIRCRAFT FOR FLIGHT .....	20
A. Propeller Installation .....	20
B. Extending and Folding the Aircraft Arms .....	21
C. Installing the Aircraft Batteries .....	22
D. Installing and Removing the Payload .....	25
E. Powering on the Aircraft and Controller .....	26
F. Powering Off the Controller and Aircraft .....	27
G. Aircraft Indicator Lights .....	28
7. CONTROLLER: THE GO FLY APPLICATION .....	29
A. Controller Home Screen .....	29
B. Go Fly Application Features .....	31
C. MSX® Mode .....	56
8. FLYING THE SIRAS AIRCRAFT .....	57
A. Compass (Magnetometer) Calibration Procedure .....	57
B. Precautions Before Flying .....	60
C. Preflight Check .....	62
D. Place the Aircraft in the Clear .....	62
E. Unfold the Controller Antennas .....	62
F. Power On the Aircraft and Controller .....	62
G. Tap the Controller Preflight Check Button .....	63
H. Flight Modes (A, P, and S) .....	63
I. Turning the Motors On and Off .....	64
J. Manual Joystick Operation .....	65

K.	Scroll Wheels: Camera Aiming and Zoom.....	66
L.	Recording Images and Video.....	66
M.	Collision Avoidance.....	66
N.	Return to Home.....	67
O.	Remove and Charge the Batteries after a Flying Session.....	67
P.	Creating and Flying a Preplanned Mission.....	67
9.	UPDATING THE CONTROLLER AND AIRCRAFT FIRMWARE.....	76
10.	LOADING MAPS INTO THE CONTROLLER.....	81
11.	AIRCRAFT MEMORY CARD.....	82
12.	PRODUCT REGISTRATION.....	84
13.	WARRANTY AND NOTICES.....	85
A.	Limited Warranty, Exclusions, and Disclaimers.....	85
B.	Ingress Protection Rating and Maintenance.....	85
C.	Legal Obligations.....	86

## TABLE OF FIGURES

Figure 2.A	SIRAS Standard Bundle.....	8
Figure 3.A	SIRAS Aircraft Front and Rear View.....	10
Figure 4.A	SIRAS Controller (Front and Top View).....	11
Figure 4.B	SIRAS Controller User Interface Ports.....	12
Figure 4.C	Controller LED Layout.....	13
Figure 4.D	Controller MicroSD Card Slot (14) and USB-C Charger Port (15).....	14
Figure 4.E	Expand and Fold the Antenna for Operation and Storage.....	15
Figure 5.A	Aircraft Battery Charger.....	16
Figure 6.A	Propeller Rotation Orientation (Top View).....	20
Figure 6.B	Extending (Left) and Locking (Right) the Aircraft Arms.....	21
Figure 6.C	Installing the Lower (Left) and Upper (Right) Batteries.....	22
Figure 6.D	Locking the Batteries in the Aircraft.....	23
Figure 6.E	Connect the Payload Using the Quick Release, Rails, and Connector.....	25
Figure 6.F	Aircraft and Controller Power Button Locations.....	26
Figure 6.G	Controller Operating Status Lights.....	27
Figure 6.H	Power Off Menu.....	27
Figure 6.I	Aircraft Status Indicator LEDs.....	28
Figure 7.A	SIRAS Controller Home Screen.....	29
Figure 7.B	Flight Record Screen.....	30
Figure 7.C	Go Fly App Flight Control Screen.....	31
Figure 7.D	Preflight Check / Flight Readiness Menu.....	33



Figure 7.E Safety Menu (Part 1).....	34
Figure 7.F Safety Menu (Part 2; Scroll Down to View).....	35
Figure 7.G Control Menu (Part 1).....	36
Figure 7.H Control Menu (Part 2, Scroll Down to View).....	37
Figure 7.I Pairing Button Cover.....	38
Figure 7.J Pressing the Pair Button (Pairing Light Flashing).....	39
Figure 7.K Pairing, Step 3.....	39
Figure 7.L Control Menu (Part 3, Scroll Down to View).....	40
Figure 7.M Control Menu (Part 4, Scroll Down to View).....	41
Figure 7.N Camera Menu.....	42
Figure 7.O Visible Camera Quick-Access Features.....	43
Figure 7.P The Video Resolution Icon (Visible Light / Video).....	45
Figure 7.Q Thermal Camera Quick-Access Features.....	46
Figure 7.R Thermal Plus Visual Display.....	47
Figure 7.S MSX Mode (Outlined Thermal) Photo.....	48
Figure 7.T Shutter Controls.....	49
Figure 7.U Button to Expose Hidden Shutter Controls.....	50
Figure 7.V Capture Mode and Image Format Settings for Visible Camera.....	51
Figure 7.W Capture Mode and Image Format Settings for Thermal Camera.....	51
Figure 7.X Video Format Settings for Thermal Camera.....	52
Figure 7.Y Radiometric Adjustments for Thermal Camera.....	53
Figure 7.Z Map Activated.....	54
Figure 7.AA Flight Telemetry.....	54
Figure 7.BB Engagement of the Collision Avoidance Feature.....	55
Figure 7.CC Collision Avoidance Active.....	56
Figure 8.A Calibrate Compass: Prompt 2.....	58
Figure 8.B Compass Calibration Step 2: Horizontal Rotation, Level.....	58
Figure 8.C Compass Calibration Step 3: Horizontal Rotation, Nose-Up.....	59
Figure 8.D Compass Calibration Successful.....	59
Figure 8.E Turning Motors On (Left) and Off (Right).....	64
Figure 8.F Joystick Controls (Left and Right, in Mode 2).....	65
Figure 8.G Mission Planning (Waypoint) Controls.....	68
Figure 8.H Drawing the First Two Waypoints.....	70
Figure 8.I Waypoint Settings and Types.....	71
Figure 8.J Waypoint Symbols on a Map.....	73
Figure 8.K Using the Keyboard to Name the Mission.....	74
Figure 9.A Swipe Left to Expose the Android Icons.....	77
Figure 9.B Tap the Circle Icon.....	78
Figure 9.C File Manager Icon.....	78
Figure 9.D File Manager—microSD Card.....	79
Figure 9.E Software Update: New Firmware.....	80
Figure 11.A microSD Card Slot on Aircraft.....	82

Figure 12.A Payload and Airframe Serial Number Locations .....84

## TABLE OF TABLES

Table 2.A SIRAS Standard Bundle.....7  
 Table 2.B Technical Specifications.....8  
 Table 3.A Aircraft Parts Description .....10  
 Table 4.A SIRAS Controller Description.....11  
 Table 4.B SIRAS Controller User Interface Ports Description.....12  
 Table 4.C Controller (Top Row) LED Function and Messages .....13  
 Table 4.D Controller (Bottom Row) LED Battery Status.....13  
 Table 5.A Aircraft Battery Charger Power-Level Indicator LEDs .....17  
 Table 5.B Charger Error Messages.....18  
 Table 5.C Charging Performance as a Function of Battery Temperature.....19  
 Table 6.A Aircraft LED 1 through LED 4 (top Row) and Status .....28  
 Table 6.B Aircraft LED 5 through LED 8 (Lower Row) and Status.....28  
 Table 7.A Go Fly App Features .....31  
 Table 7.B Connection Status and Error Indicators .....32  
 Table 7.C Signal and Battery Levels .....34  
 Table 7.D Visible Camera Quick-Access Features .....44  
 Table 7.E Thermal Camera Quick-Access Features.....46  
 Table 7.F Shutter Controls .....49  
 Table 8.A Mission Planning (Waypoint) Controls .....69  
 Table 8.B Waypoint Types .....71  
 Table 8.C Waypoint Settings .....72  
 Table 8.D Waypoint Icons .....73  
 Table 12.A Serial Numbers .....84

### Key to Symbols:

- 
-  **This is a warning notice. Failure to heed warnings can lead to damage or injury.**
  -  **This is an informational notice, calling attention to an important detail.**
  -  **This is a tip that can improve your effectiveness in using the product.**
-

## 1. SIRAS DOCUMENTATION

The SIRAS™ bundle comes with three documents:

- The *SIRAS™ Standard Bundle User Manual* (this manual). This manual is a complete reference guide to the aircraft and controller. It also includes essential information for proper battery care. It contains all safety warnings and procedures for flying the aircraft.
- The *SIRAS™ Quick Start Guide*. This very brief document contains the minimum information needed to power on and fly the aircraft. This guide presumes that the reader is an experienced pilot and well-versed in safety requirements, aircraft handling, and battery care.
- The *SIRAS™ Battery Safety Instruction Guide*. This guide contains detailed information about battery safety and care, most of which is also included in the *User Manual*.

## 2. SIRAS STANDARD BUNDLE / SPECIFICATIONS

The SIRAS Standard Bundle comes complete in a lightweight, protective case with the items needed for various operations. Spare parts and accessories are available from your local dealer. Find more information at [www.flir.com/siras](http://www.flir.com/siras).

**TABLE 2.A SIRAS STANDARD BUNDLE**

	ITEM	QUANTITY	DESCRIPTION
1	SIRAS Aircraft	1	Requires two batteries and four propellers
2	Foldable Propellers (Clockwise)	2	Clockwise rotation
3	Foldable Propellers (Counterclockwise)	2	Counterclockwise rotation
4	Quick-Release Vue® TV128 or alternative <sup>1</sup>	1	Gimbaled thermal and visible camera payload
5	Controller	1	Dual-band 2.4/5.8 GHz with internal battery
6.	Aircraft Batteries	2	Top and bottom orientation 4S rechargeable LiPo
7	Aircraft Battery Charger	1	Charges up to two aircraft batteries simultaneously
8	Soft Case	1	Carries all items in the SIRAS Standard Bundle
9	Controller Charger	1	Wall power supply to USB type C connector

<sup>1</sup> Upon release starting in 2023, additional or alternative payloads will be available. Check with your dealer for features and pricing.



FIGURE 2.A SIRAS STANDARD BUNDLE

TABLE 2.B TECHNICAL SPECIFICATIONS

SIRAS AIRCRAFT (BATTERIES AND GIMBAL)	
<b>Weight</b>	3.1 kg (6.8 lb)
<b>Diagonal Wheelbase</b>	500 mm (19.7 in)
<b>Maximum Ascending Speed</b>	6 m/s (13.4 mph)
<b>Maximum Descending Speed</b>	4 m/s (9 mph)
<b>Maximum Tilt Angle</b>	30°
<b>Maximum Speed (Sport Mode)</b>	18 m/s (40 mph)
<b>Maximum Wind Resistance (Hovering)</b>	10 m/s (22 mph, Beaufort Scale of 5)
<b>Hover Accuracy in GPS Mode</b>	Vertical: ±0.5 m (±1.6 ft), Horizontal: ±1.5 m (±5 ft)
<b>Ingress Protection Class</b>	IP54
<b>Operating Temperature</b>	-10°C to 40°C (14°F to 104°F)
<b>Maximum Flight Time</b>	31 min (no wind, no hovering, batteries drained to 10%, 5 m/sec speed)
<b>Forward Obstacle Detection</b>	Detection Range of 0.91 m to 30.5 m (3 ft to 100 ft) at an Effective Speed of <5 m/s (11 mph)



<b>Vue TV128 GIMBAL PAYLOAD</b>	
<b>Axes (Rotation)</b>	3
<b>Range of Controlled Rotation</b>	Tilt Axis: -90° to 15°
<b>Range of Vibration Angle</b>	±0.02°
<b>Maximum Control Speed</b>	120°/s
<b>Visible (EO) Camera Resolution</b>	16 MP Standard Mode and 20 MP Mapping Mode
<b>Visible Camera Optics</b>	Effective Focal Length (EFL) 4.8 mm 67° HFOV F/# 1/2.3
<b>Thermal Camera Resolution</b>	640 × 512 radiometric Teledyne FLIR Boson®
<b>Thermal Accuracy</b>	<±5°C @ 0°C to 100°C (<±9°F @ 32°F to 212°F)
<b>Thermal Camera Optics</b>	Effective Focal Length (EFL) 13.6mm 32° HFOV F/# 1.0
<b>SMART BATTERY (EACH)</b>	
<b>Capacity</b>	6,000 mAh
<b>Voltage</b>	15.2 V
<b>Battery Type</b>	LiPo 4S
<b>Operating Temperature</b>	5°C to 50°C (41°F to 122°F)
<b>Maximum Charge Current</b>	6 A
<b>REMOTE CONTROLLER</b>	
<b>Frequency</b>	Dual-band 2.4/5.8 GHz

### 3. SIRAS AIRCRAFT

The principal features of the SIRAS aircraft are illustrated in [Figure 3.A](#) and the corresponding table.

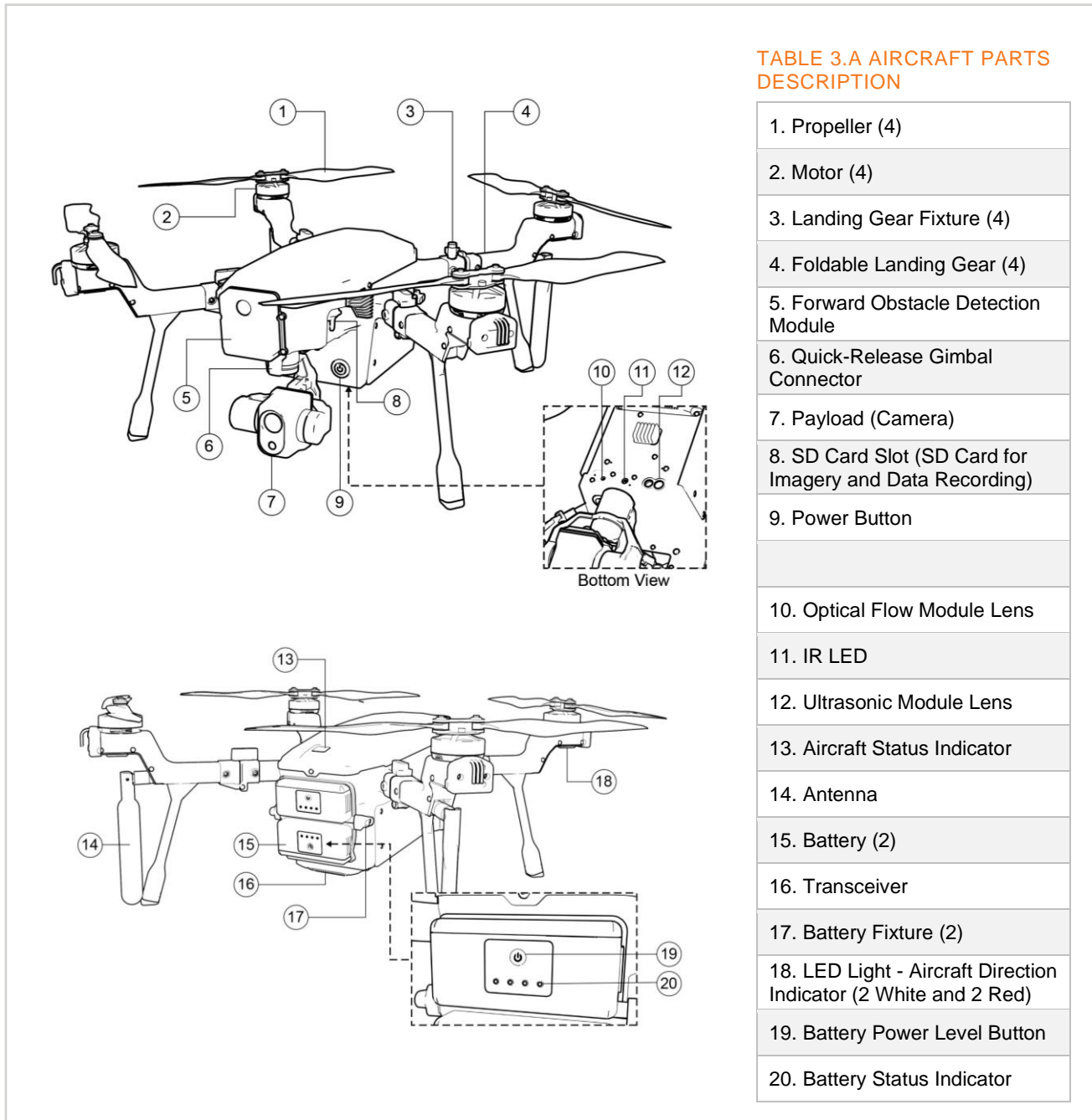
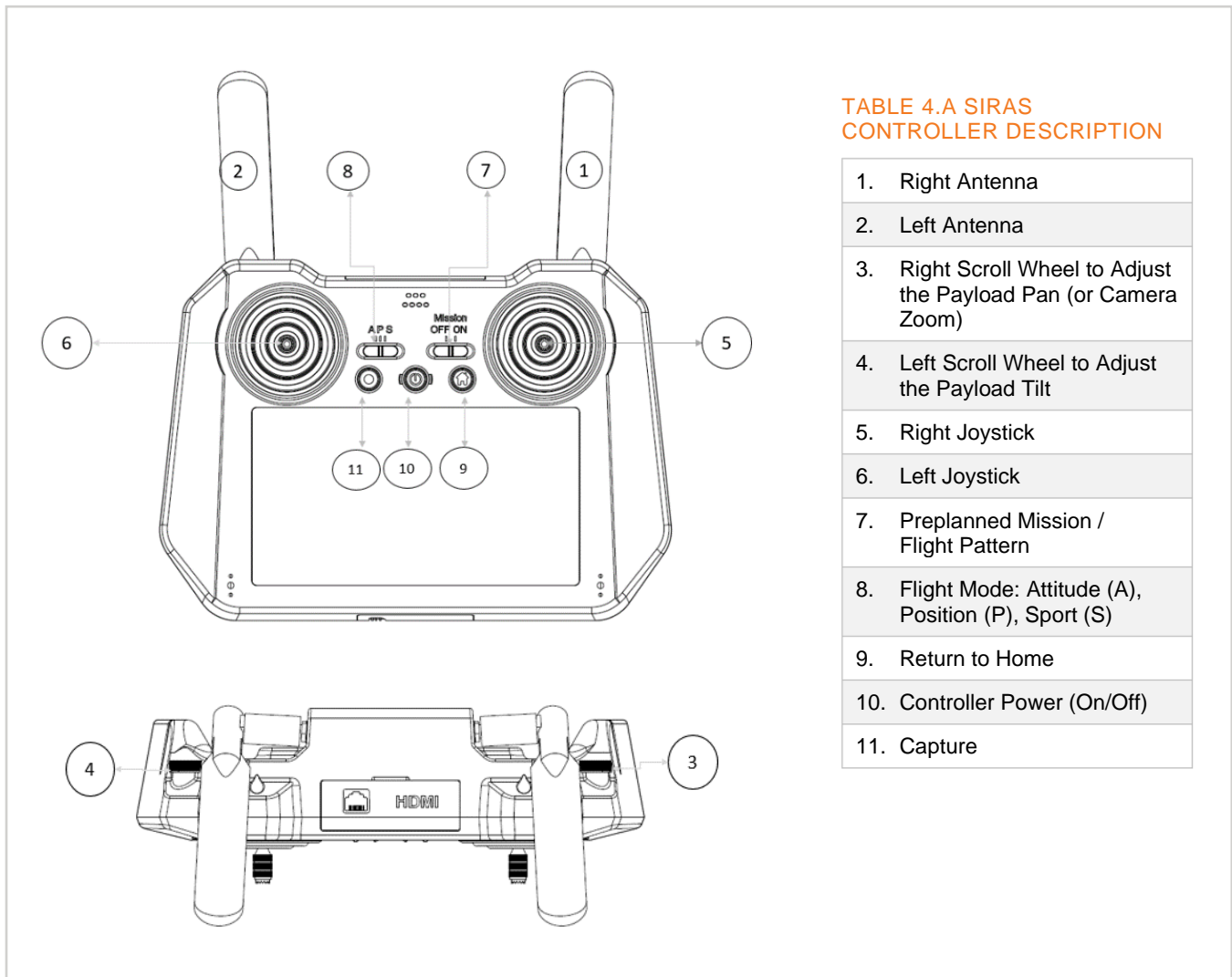

FIGURE 3.A SIRAS AIRCRAFT FRONT AND REAR VIEW

## 4. SIRAS CONTROLLER

### A. Controller Layout

The SIRAS controller layout is described in the following figures and the corresponding tables. The SIRAS controller is default set to a Mode 2 RC transmitter control layout. A Mode 2 RC transmitter uses the right stick to control roll and pitch, while the left stick controls yaw and throttle.



**TABLE 4.A SIRAS  
CONTROLLER DESCRIPTION**

1.	Right Antenna
2.	Left Antenna
3.	Right Scroll Wheel to Adjust the Payload Pan (or Camera Zoom)
4.	Left Scroll Wheel to Adjust the Payload Tilt
5.	Right Joystick
6.	Left Joystick
7.	Preplanned Mission / Flight Pattern
8.	Flight Mode: Attitude (A), Position (P), Sport (S)
9.	Return to Home
10.	Controller Power (On/Off)
11.	Capture

FIGURE 4.A SIRAS CONTROLLER (FRONT AND TOP VIEW)

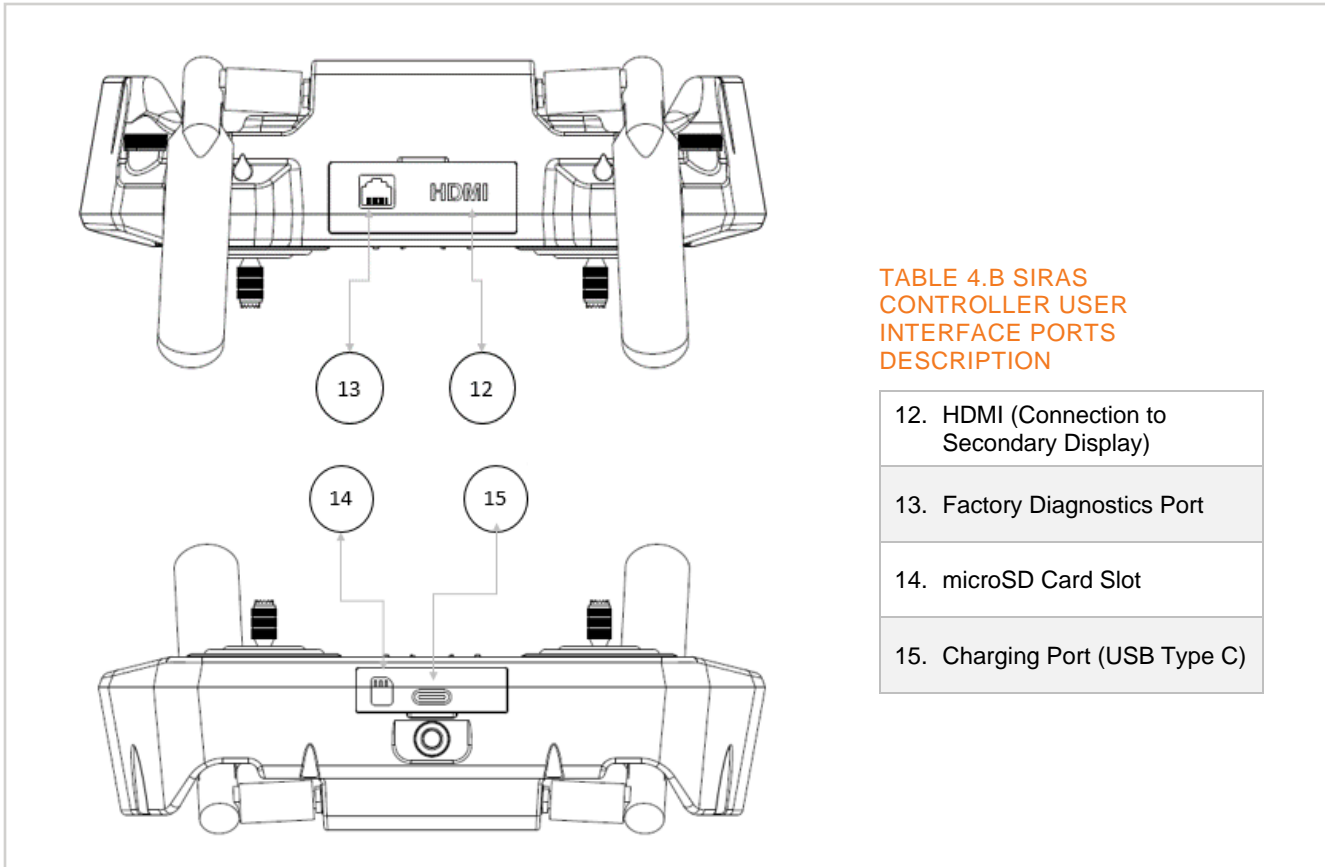

FIGURE 4.B SIRAS CONTROLLER USER INTERFACE PORTS

**A1. Joysticks**

Joystick operation is described in [8-J, Manual Joystick Operation](#).

**A2. Scroll Wheels**

The controller has spring-loaded scroll wheels on the left and right sides. See [8.K, Scroll Wheels: Camera Aiming and Zoom](#).

**A3. Preplanned Mission / Flight Pattern**

The Mission switch, when ON, causes the aircraft to execute a preplanned mission. See [8.P, Creating and Flying a Preplanned Mission](#).

**A4. Flight Modes (A, P, and S)**

Flight modes enable flight using GPS lock (low-speed Position Mode or high-speed Sport Mode) or no position lock (Attitude Mode). When the joysticks are released, the aircraft will hold position and hover in Position or Sport Modes. See [8.H, Flight Modes \(A, P, and S\)](#).

**A5. Return to Home**

The “House” button initiates a Return to Home action. See [8.N, Return to Home](#).

## B. Controller LED Definitions and Functions

Controller LEDs are shown in [Figure 4.C](#). The top row of LEDs (1 through 3) indicates the power status, pairing (between aircraft and controller), and transmission strength. The bottom row of LEDs (4 through 7) indicates the remaining battery power. The LED functions/messages are defined in

[Table 4.C](#) and [Table 4.D](#) Controller (Bottom Row) LED Battery Status

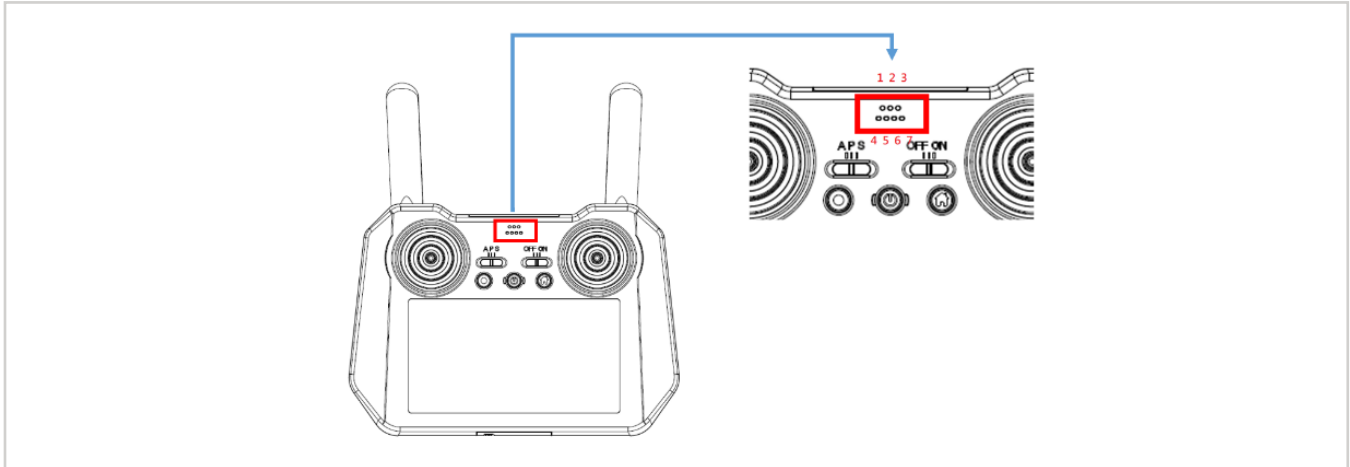

FIGURE 4.C CONTROLLER LED LAYOUT

TABLE 4.C CONTROLLER (TOP ROW) LED FUNCTION AND MESSAGES

	ON	BLINKING ONCE PER SECOND	BLINKING ONCE PER 2/3 SECOND	BLINKING ONCE PER 1/3 SECOND	OFF
<b>LED 1 – Power Status</b>	Power On	Powering On	N/A	Abnormality - Unable to Complete Process	Power Off
<b>LED 2 – Pairing Status</b>	Paired	Pairing	N/A	N/A	Pairing Failed
<b>LED 3 – Transmission Signal Status</b>	Signal Quality 100%	Signal Quality 66%~99%	Signal Quality 33%~65%	Signal Quality 1%~32%	Signal Lost

TABLE 4.D CONTROLLER (BOTTOM ROW) LED BATTERY STATUS

	CONTROLLER BATTERY LEVEL				
	76% - 100%	51% - 75%	26% - 50%	0% - 25%	0%
LED 4	●	●	●	✱	○
LED 5	●	●	●	○	○
LED 6	●	●	○	○	○
LED 7	●	○	○	○	○

○ OFF ✱ FLASH ● ON

### C. Controller Battery Charging

To charge the controller battery, open the protective cover to access the USB type C charger port, as shown in [Figure 4.D](#), item 15. Connect the provided USB type C charging cable from wall power to the controller. The controller is a Quick Charge Compatible device. After the charging is completed, remove the charging cable, and lose the protective cover over the charging port. The controller battery should operate for approximately 210 minutes before requiring recharging.

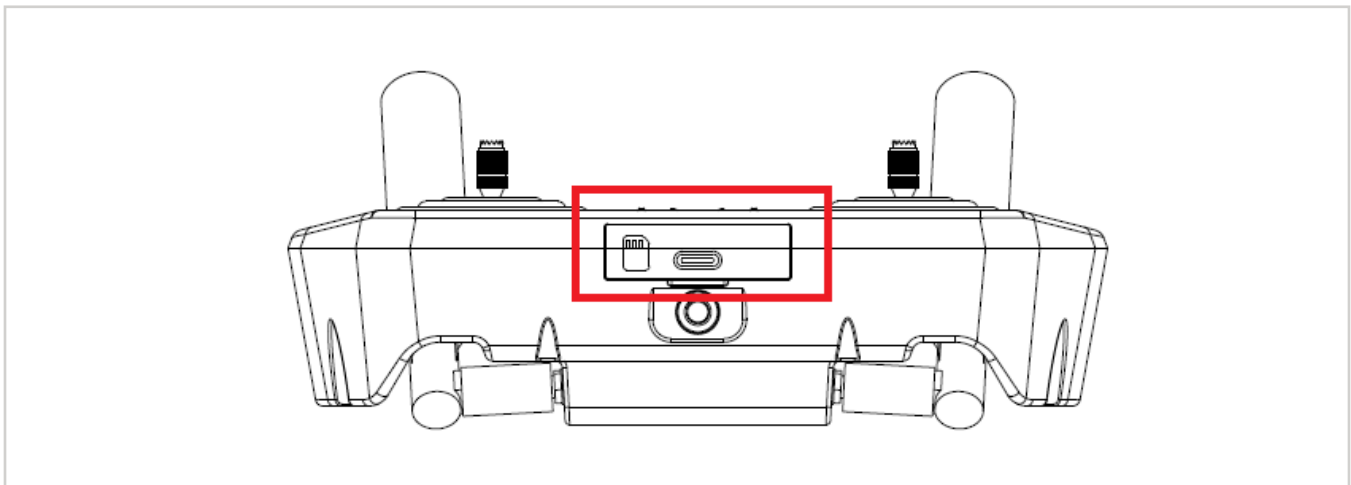

FIGURE 4.D CONTROLLER MICROSD CARD SLOT (14) AND USB-C CHARGER PORT (15)

The controller's battery capacity is 74 Wh. The controller can support the following USB charge rates: 5V@3A, 9V@2A, or 12V@1.5A. The maximum allowable charging power is 18 W. Batteries should be discharged to approximately 40%-60% capacity before long-term storage.

### D. Controller MicroSD Card

To install a microSD card, open the protective cover to access the microSD slot shown in [Figure 4.D](#), item 14. Insert the microSD card into the slot (contacts up) and press it in until it engages and is held in place. The

microSD card slot is spring loaded, meaning that depressing an installed microSD card will partially eject the card. It is recommended to grab the microSD card with small tweezers such as those included in the SIRAS Accessory pack. Close the protective cover over the microSD slot.

A microSD card is used to store imaging data, as described in [7.B6iii Camera Menu](#).

A microSD card is also used to perform a firmware update on the controller. See Chapter 9, [Updating the Controller and Aircraft Firmware](#).

## E. Controller Antenna

The controller antenna should be stored in the folded position flush with the back of the controller. Expand, or unfold, the antenna from the back of the controller during operation of the SIRAS, as shown in [Figure 4.E](#).

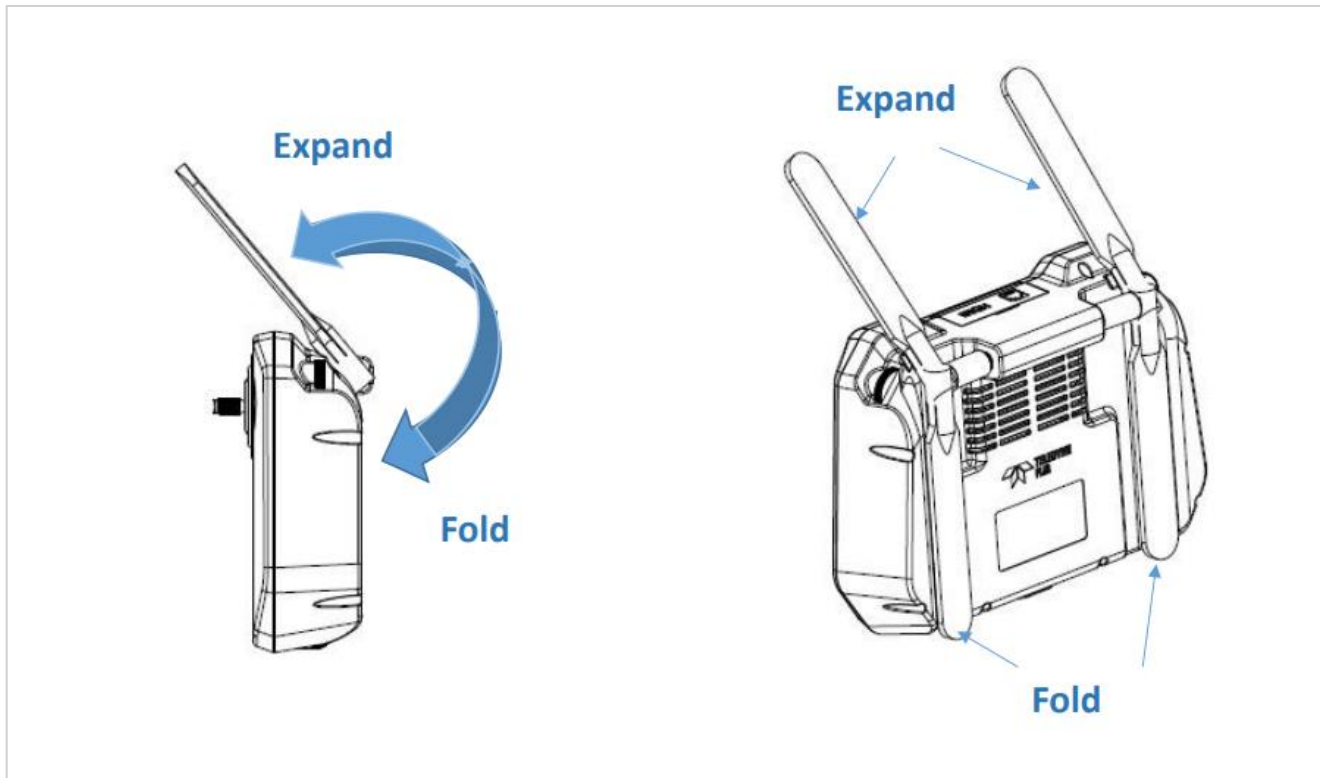

FIGURE 4.E EXPAND AND FOLD THE ANTENNA FOR OPERATION AND STORAGE

## 5. AIRCRAFT BATTERY SAFETY / CHARGING

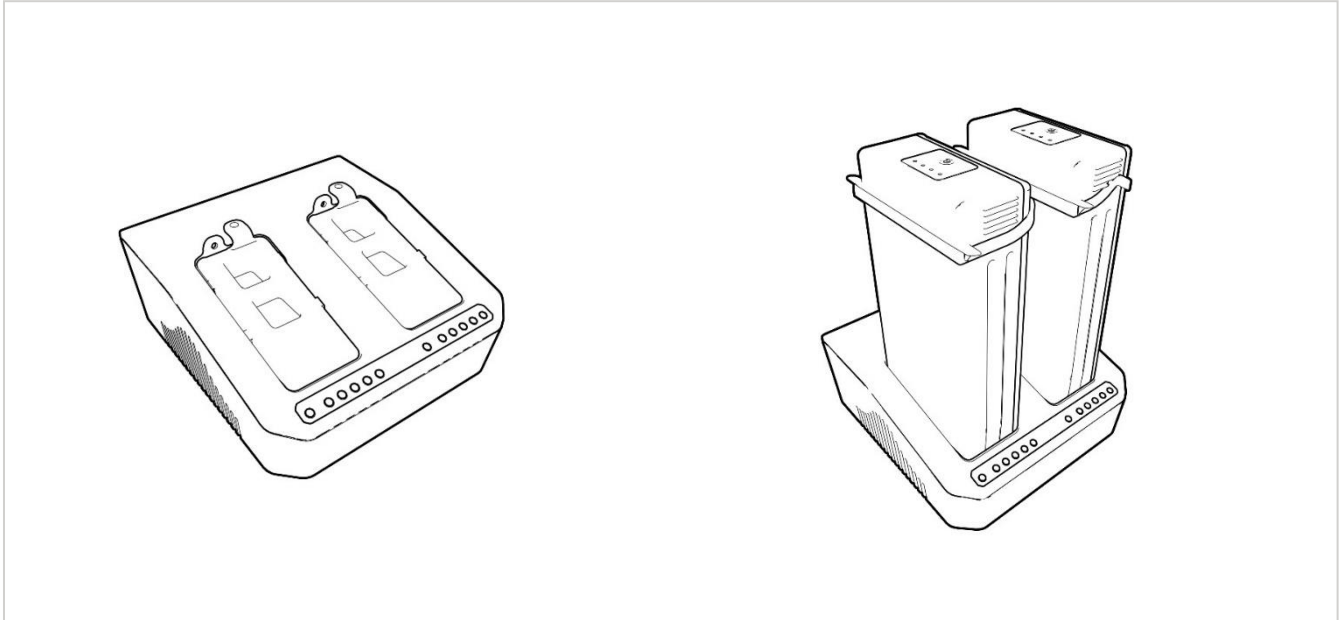





FIGURE 5.A AIRCRAFT BATTERY CHARGER

### A. Aircraft Battery Safety

---

-  **Never drain batteries to less than 5% charge remaining, as this may permanently damage the batteries' ability to recharge.**
  -  **Remove and charge the batteries promptly after a flight. Batteries left in a powered-off aircraft will eventually drain down to 0% and be damaged.**
  -  **Batteries will drain (very slowly) even when not in the aircraft – this is another reason to keep them charged.**
  -  **See additional warnings on the battery label.**
-



## B. Aircraft Battery Charging Instructions

When the battery is connected to the charger, charging will begin and the power level indicator LEDs will illuminate and flash as described in [Table 5.A](#). When all five power level indicator LEDs are illuminated, charging is complete. The charger will emit a completion sound. Follow the workflow to charge aircraft batteries.

1. Connect the aircraft battery charger to a power source.
2. Turn off the power switch on the back of the charger.

---

 **Inspect the pins in the battery charger. If they are bent, do not insert the battery. Contact your sales representative for remediation.**

---

3. Insert up to two aircraft batteries into the charger; making sure they are oriented correctly.

---

 **The batteries fit into the charger in only one orientation. Do not force the batteries into the charger, as this will damage the charger pins.**

---

4. Turn on the power switch on the back of the charger. The power-level indicator LEDs on the charger will begin to flash.
5. Charge batteries to full as indicated by the illumination of all power level indicator LEDs on the charger.























































TABLE 5.A AIRCRAFT BATTERY CHARGER POWER-LEVEL INDICATOR LEDs

CAPACITY	LED (100%)	LED (80%)	LED (60%)	LED (40%)	LED (20%)
<20%	○	○	○	○	★
>20%	○	○	○	★	●
>40%	○	○	★	●	●
>60%	○	★	●	●	●
>80%	★	●	●	●	●
100%	●	●	●	●	●

○ OFF   ★ FLASH   ● ON

Table 5.B provides diagnostic information when batteries are not charging as expected. Errors can often be cleared by turning off the charger, removing the batteries, reinserting them, and turning the charger back on. If errors persist, notify your customer service representative.

**TABLE 5.B CHARGER ERROR MESSAGES**

LED (ERROR)	LED (100%)	LED (80%)	LED (60%)	LED (40%)	LED (20%)	DESCRIPTION OF THE INDICATOR LIGHTS
						Output overvoltage*
						Output overcurrent*
						Charger temperature is too high+
						Unmatched voltage of the balancing port and main port*
						Low voltage of AC power output*
						Battery voltage is too low*
						Battery voltage is too high*
						Battery temperature is too low, <5°C (41°F) **
						Battery temperature is too high, >50°C (122°F) +
<p>○ OFF    FLASH   ● ON</p> <p>* Contact FLIR Service            + Allow cooling before charging batteries            ** Warm batteries to at least 5°C (41°F) before charging</p>						

## C. Aircraft Battery Charger Performance as a Function of Temperature

[Table 5.C](#) details the charger performance as a function of ambient temperature. For optimum charging performance, keep batteries between 16°C and 45°C (61°F – 113°F).

**TABLE 5.C CHARGING PERFORMANCE AS A FUNCTION OF BATTERY TEMPERATURE**

BATTERY TEMPERATURE	CHARGING PERFORMANCE
<5°C (41°F)	No Charge - Error LED will illuminate
6°C –15°C (42°F – 59°F)	1.2A Slow Charge
16°C –45°C (61°F – 113°F)	Normal 6A Charge
46°C –50°C (115°F – 122°F)	1.2A Slow Charge
> 50°C (122°F)	No Charge - Error LED will illuminate

## 6. REPARING THE SIRAS AIRCRAFT FOR FLIGHT

### A. Propeller Installation

The SIRAS aircraft uses foldable carbon-fiber-reinforced nylon propellers installed on the aircraft. The motors will spin two propellers in a clockwise (CW) direction and two in a counterclockwise (CCW) direction. Each propeller is labeled with the correct direction of rotation (CW or CCW). When replacing the propellers, refer to [Figure 6.A](#) for correct orientation.

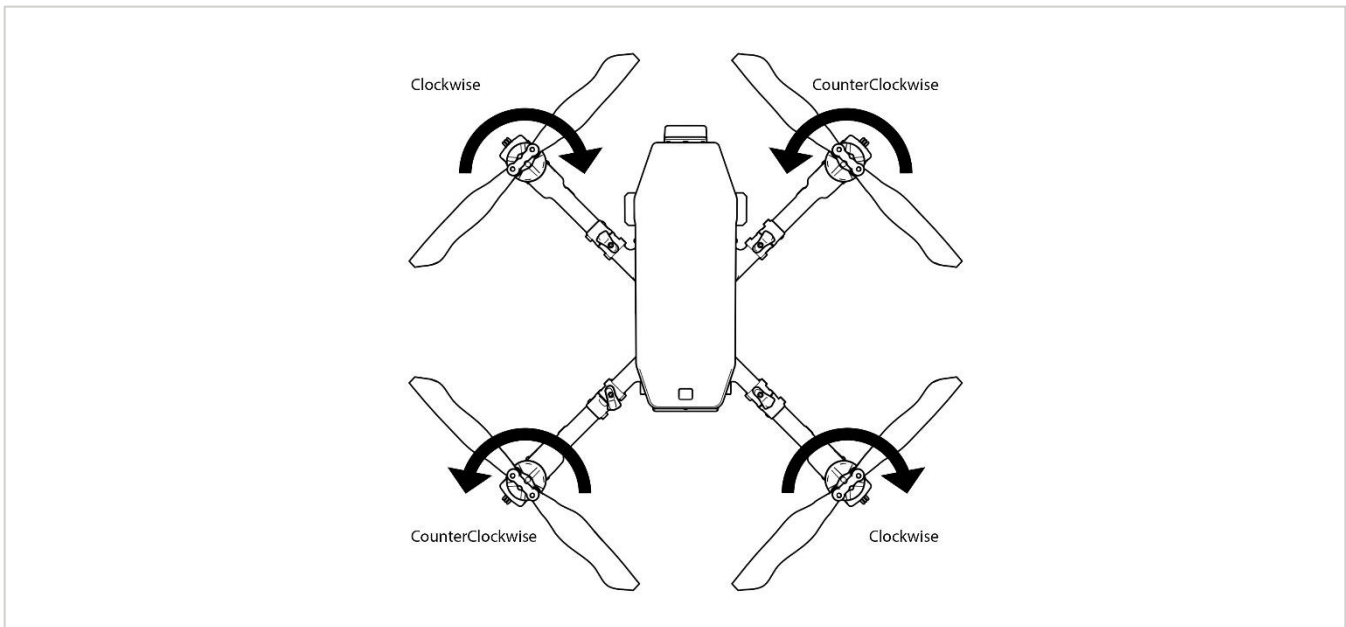

FIGURE 6.A PROPELLER ROTATION ORIENTATION (TOP VIEW)

## B. Extending and Folding the Aircraft Arms

Extend the foldable section of the aircraft arms until they are aligned with the non-movable base section of the arms. Turn the lock clockwise until it clicks into place to secure the arm in the extended position, as shown in [Figure 6.B](#).

Before placing the aircraft in the soft case, turn the lock counterclockwise to release the folding section of the aircraft arm. Fold the arm under the aircraft.

---

 **Two of the aircraft arms have antennas. Do not apply force to the antennas when extending and folding the aircraft arms.**

 **For best communication results, leave the antennas pointing down.**

---

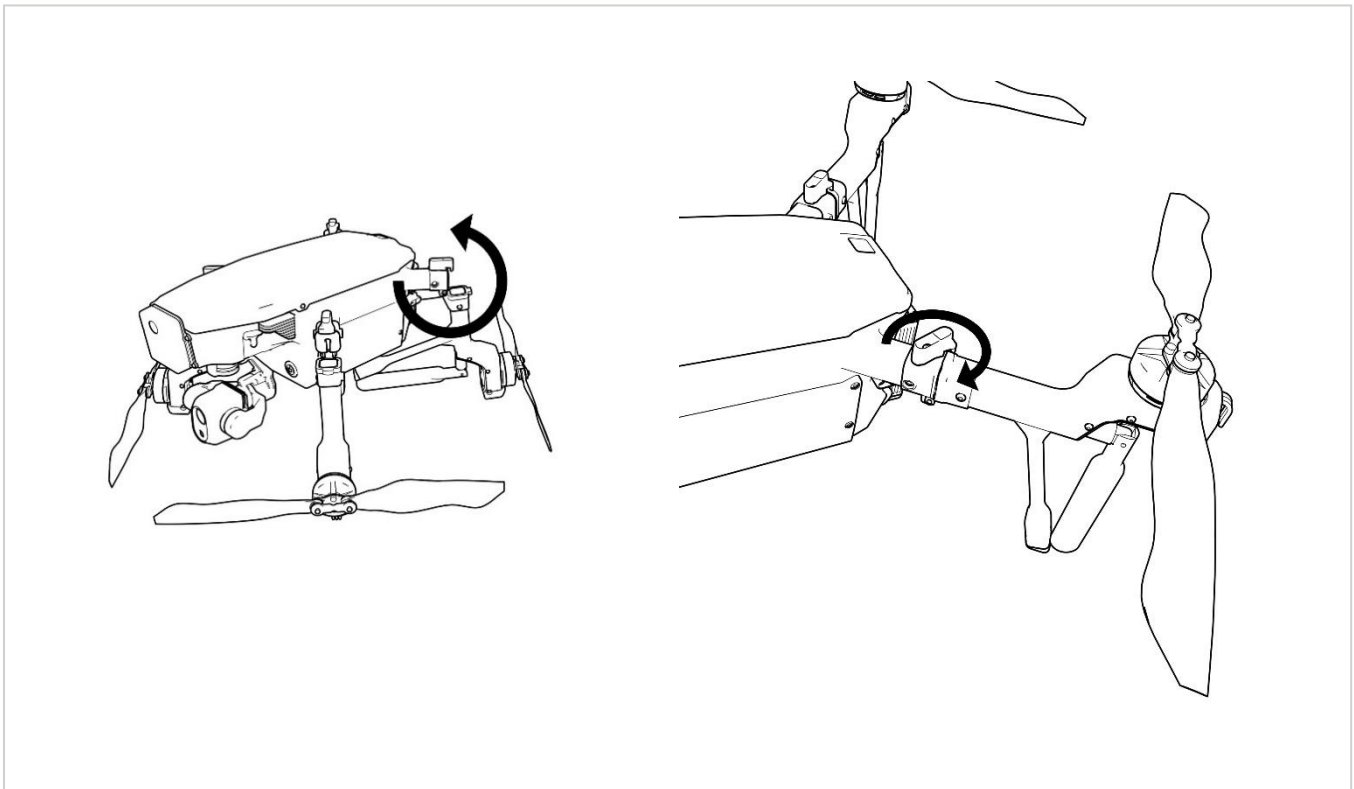

FIGURE 6.B EXTENDING (LEFT) AND LOCKING (RIGHT) THE AIRCRAFT ARMS

## C. Installing the Aircraft Batteries

SIRAS operation requires two batteries. These batteries are installed one above the other in the aircraft battery slots. Before inserting the batteries into the aircraft, rotate the two battery locks upward in the *reverse* of the “locking” direction shown in [Figure 6.D](#) (battery slots will be empty).

---

**⚠ Inspect the contact pins in the aircraft’s battery compartment. If the pins are bent, do not insert the battery. Contact your sales representative.**

---

The upper and lower batteries have different side gasket shapes that match the airframe shape and ensure correct orientation.

---

**⚠ If a battery does not insert fully into a slot (because the side gaskets obstruct it), reverse it and insert it into the other slot.**

---

Both batteries include locking tabs, circled in red in [Figure 6.C](#), that enable securing them into the aircraft. Insert the lower battery with the locking tabs facing up. Insert the upper battery with the locking tabs facing down.

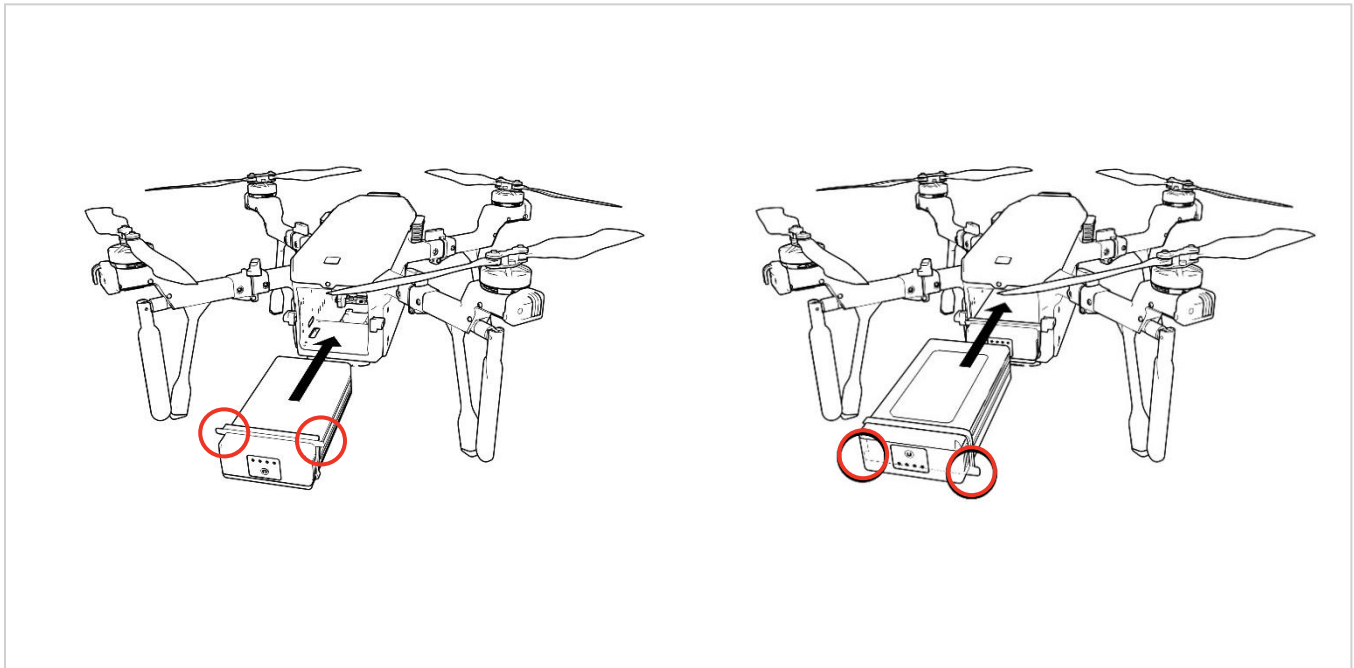

FIGURE 6.C INSTALLING THE LOWER (LEFT) AND UPPER (RIGHT) BATTERIES

Insert both batteries until the gaskets are in contact with the aircraft and the locking tabs nearly touch the battery locks. Before operating the aircraft, rotate the two battery locks downward to secure the batteries in place, as illustrated in [Figure 6.D](#).

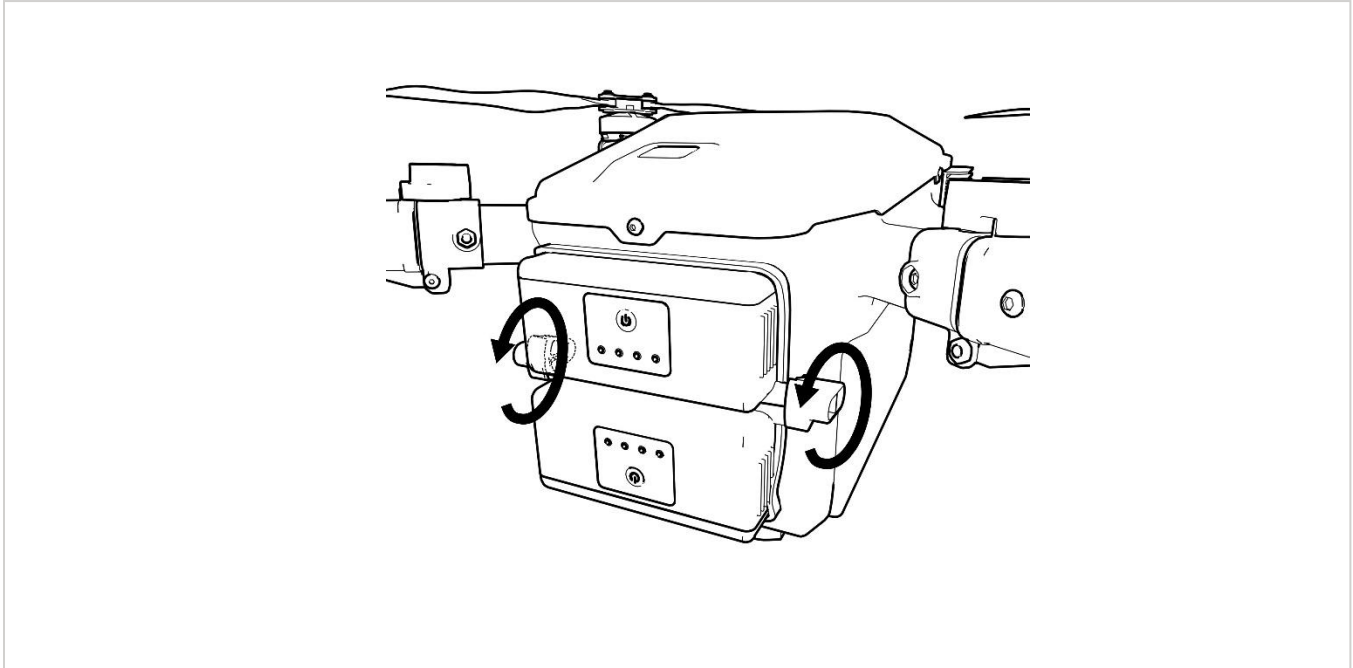

FIGURE 6.D LOCKING THE BATTERIES IN THE AIRCRAFT

### **C1. Use Batteries in Pairs**

To ensure consistent battery efficiency, use batteries in pairs. Use the included labels to designate battery pairs within your supply of batteries. Mixing battery pairs may lead to inconsistent battery drain and reduced battery life and flight time.

- 
- ⚠ Do not fly SIRAS with only one battery. Doing so can cause the battery to overheat, which may damage the battery or cause a fire. Furthermore, it exposes the open battery bay to the environment and shifts the aircraft's inertia. Flying SIRAS with only one battery voids all warranties. The pilot accepts all liability for incidents related to this misuse.**
  - ⚠ The two aircraft batteries in use should have charge levels within 5% of each other. Charge level differences greater than 5% will cause both batteries to wear more quickly, diminishing aircraft performance. Precise charge levels are displayed on the controller screen; see [7.B5](#).**
- 

### **C2. Battery Operating Temperature**

The battery operating temperature is 5°C to 50°C (41°F to 122°F). SIRAS operating temperature is -10°C to 40°C (14°F to 104°F). If the batteries are colder than 5°C (41°F), they will likely not operate properly.

- 
- ① **To operate SIRAS at temperatures between  $-10^{\circ}\text{C}$  and  $5^{\circ}\text{C}$  ( $14^{\circ}\text{F}$  and  $41^{\circ}\text{F}$ ), the batteries must be warmed to above  $5^{\circ}\text{C}$  ( $41^{\circ}\text{F}$ ) prior to installation and flight.**
- 

Once batteries installed in the aircraft and the aircraft is flying, heat generated within the aircraft will maintain the batteries at an appropriate temperature.

### **C3. Remove Batteries When Not in Use**

---

- ⚠ **Remove the batteries if you do not plan to use the aircraft during the next 6 hours.**
- ⚠ **Do not store the batteries in cold environments below  $5^{\circ}\text{C}$  ( $41^{\circ}\text{F}$ ).**
- 

### **C4. Batteries Can Be Hot Swapped**

You can replace batteries, one at a time, while the aircraft is powered on. To do this, unfasten the battery locks and carefully remove just ONE battery without disturbing the other. Replace it with a fresh battery and repeat the process in the other battery slot. As previously noted, use batteries with matching charge levels.

---

- ⚠ **Do not hot swap batteries if the ambient temperature exceeds  $37^{\circ}\text{C}$  ( $100^{\circ}\text{F}$ ).**
-



## D. Installing and Removing the Payload

The SIRAS aircraft includes a quick-connect payload system that enables modularity and multi-mission flexibility on one aircraft.

All SIRAS payloads are equipped with a quick-release mechanism that is activated by compressing the levers on each side at the top of the gimbal. To install any SIRAS payload, gently press the levers on the gimbal and, with the gimbal flush against the aircraft and the levers even with the forward tabs, slide the payload toward the aircraft along the rails until it locks. To remove the payload, depress the gimbal tabs and gently slide the gimbal away from the aircraft body until it is free of the rails.

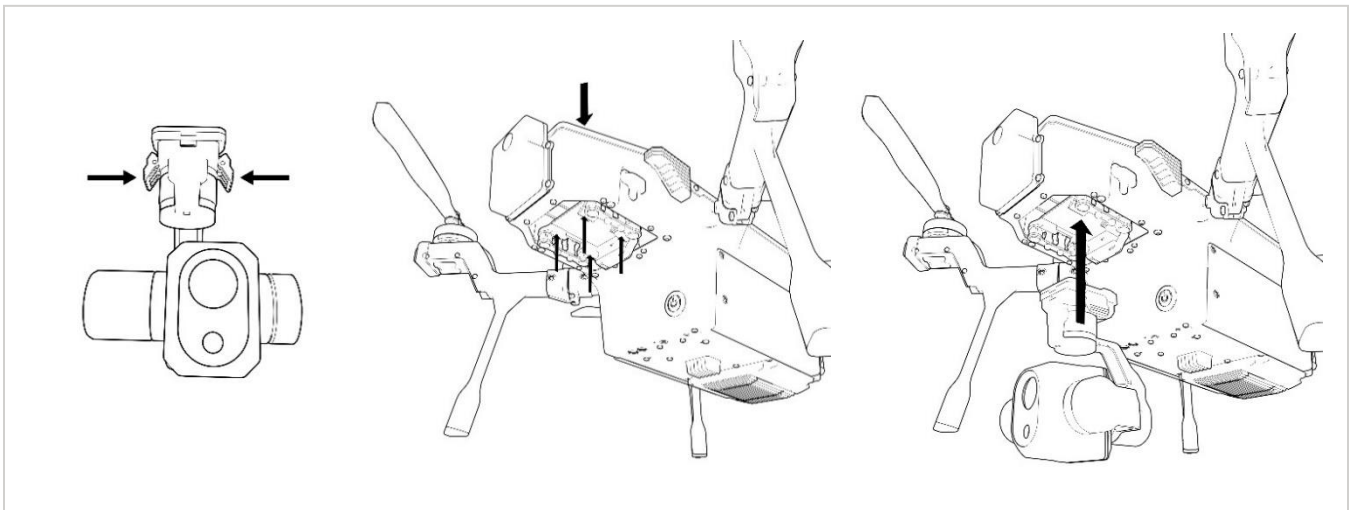

FIGURE 6.E CONNECT THE PAYLOAD USING THE QUICK RELEASE, RAILS, AND CONNECTOR

## E. Powering on the Aircraft and Controller

### E1. Power ON the Aircraft

Power on the aircraft before powering on the controller. The main power button for SIRAS is on the front panel behind the payload ([Figure 6.F](#)). Press and hold the button once for one to two seconds. When activated, the aircraft will turn on its running lights, emit an initiation sound, gently move the propellers, orient the camera gimbal, and flash various LED lights.

### E2. Power ON the Controller

After powering on the aircraft, turn on the controller by pressing and holding its power button ([Figure 6.F](#)) for one second. The blue LED lights will illuminate, indicating that the flight app is loading. The controller and aircraft will then go initiate a connection sequence that establishes communication with each other and with geo-positioning satellites. This typically takes one minute to complete. When ready, the “Go Fly” icon to appear on the controller home screen.

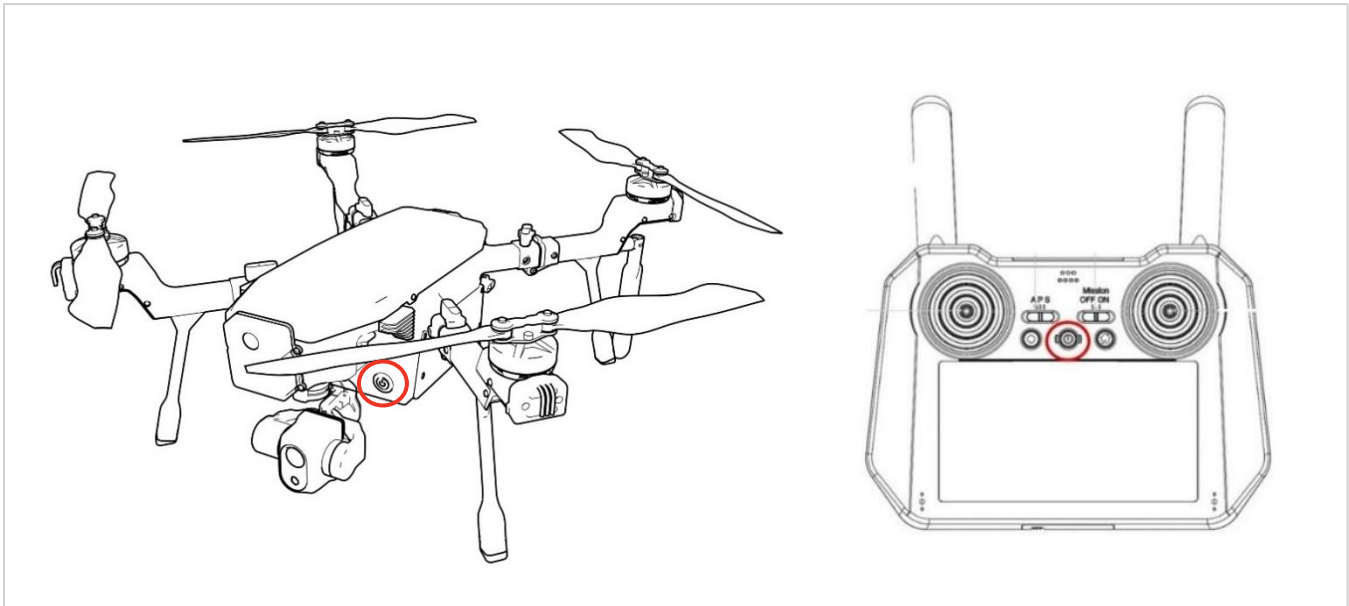

FIGURE 6.F AIRCRAFT AND CONTROLLER POWER BUTTON LOCATIONS

As shown in [Figure 6.G](#), the illumination of the three top LEDs indicates that the aircraft and controller are successfully paired. If they are blinking or OFF, the controller is not paired with the aircraft or the aircraft has not completed its power-up cycle. See [Table 6.A](#) and [Table 6.B](#) to interpret the diagnostic information provided by the LEDs.

The manufacturer has established the pairing settings between the controller and the aircraft. If pairing settings need to be re-established, see the instructions in section [7.B6ii](#).

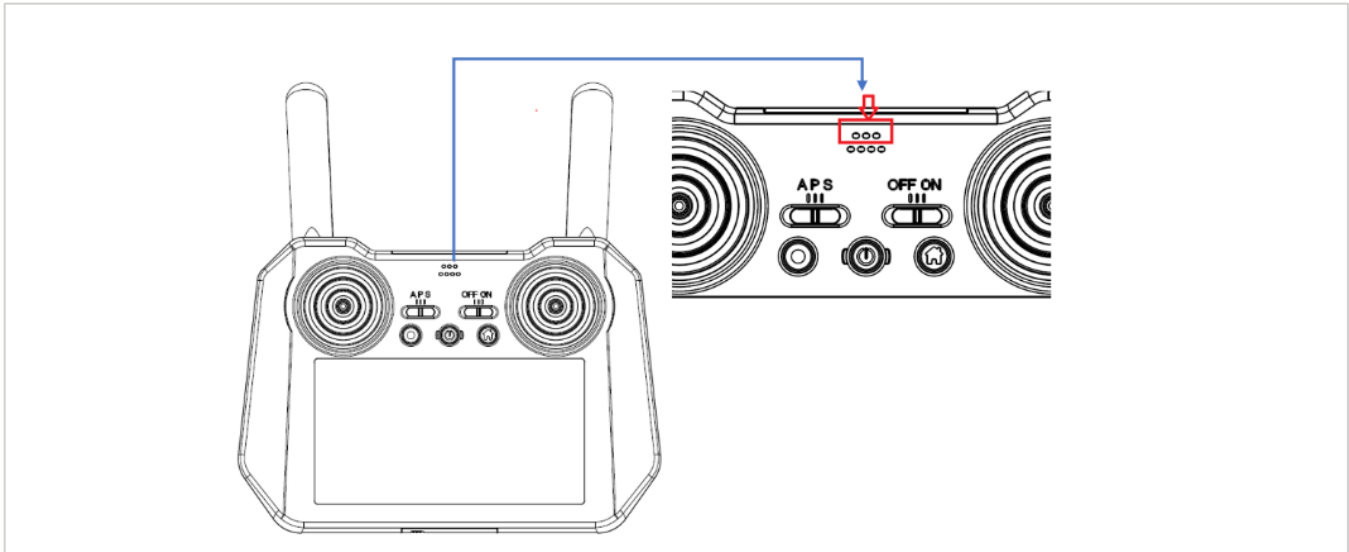

FIGURE 6.G CONTROLLER OPERATING STATUS LIGHTS

## F. Powering Off the Controller and Aircraft

Turn off the controller by pressing the power button for about one second. This will open a menu on the controller screen with options to power off, restart the controller, or take a screenshot ([Figure 6.H](#)). Tap “Power Off” on the screen to initiate the controller power-off sequence.

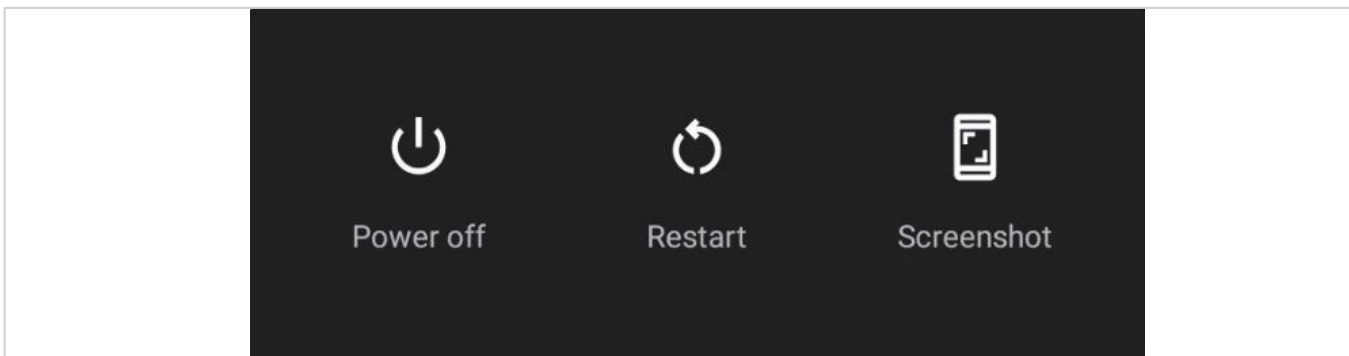

FIGURE 6.H POWER OFF MENU

To power off the aircraft, press and release the power button. Then press and hold the power button for two seconds.

## G. Aircraft Indicator Lights

There are eight LED indicators at the rear of the airframe, as seen in [Figure 6.I](#). These LED indicators provide diagnostic and status information as described in [Table 6.A](#) and [Table 6.B](#).

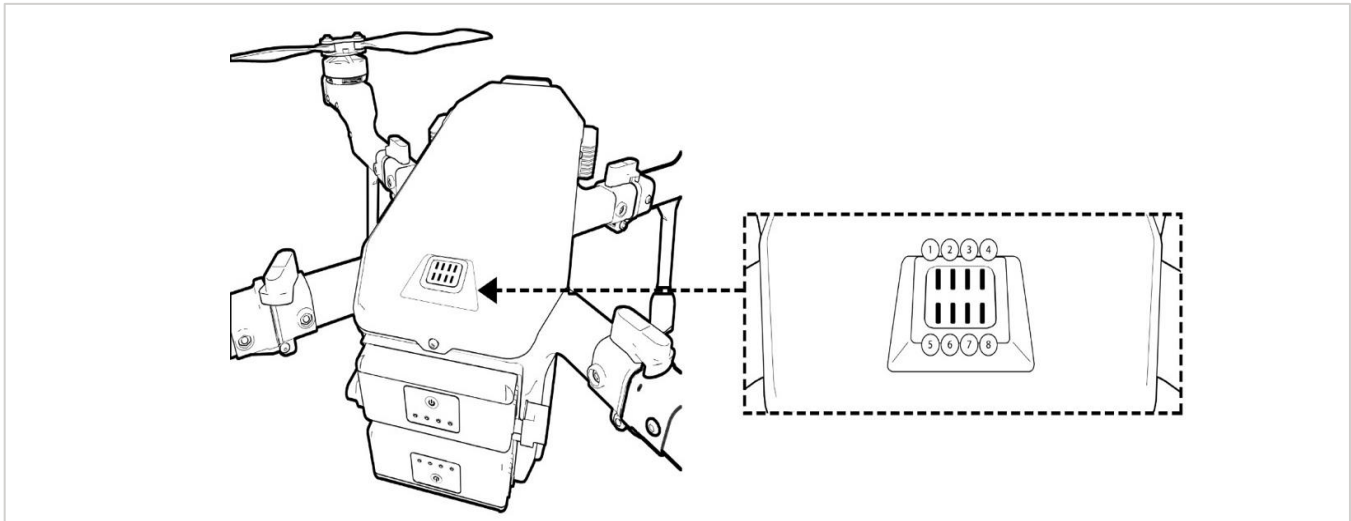

FIGURE 6.I AIRCRAFT STATUS INDICATOR LEDES

TABLE 6.A AIRCRAFT LED 1 THROUGH LED 4 (TOP ROW) AND STATUS

LED 1	LED 2	LED 3	LED 4	STATUS
✱	●	●	●	Normal
✱	○	○	●	Battery status failure
✱	○	●	○	IR locating failure
✱	●	○	○	Radar height positioning module failure
✱	○	●	●	Image loading failure
✱	●	○	●	Power management system failure

○ OFF ✱ FLASH ● ON

TABLE 6.B AIRCRAFT LED 5 THROUGH LED 8 (LOWER ROW) AND STATUS

	LED COLOR	STATUS
LED 5	●	LED on solid red: Calibration failure; compass error LED off: Normal
LED 6	●	LED on solid green: Barometer error LED off: Normal
LED 7	●	LED on solid white: Pressure is not stable LED off: Pressure is stable
LED 8	●	LED blinking blue: GPS convergence is not complete LED off: GPS convergence is complete

## 7. CONTROLLER: THE GO FLY APPLICATION

### A. Controller Home Screen

When powered up, the controller home screen ([Figure 7.A](#)) will be displayed, providing access to Overall Flight Status and Flight Records and allowing the pilot to Go Fly.

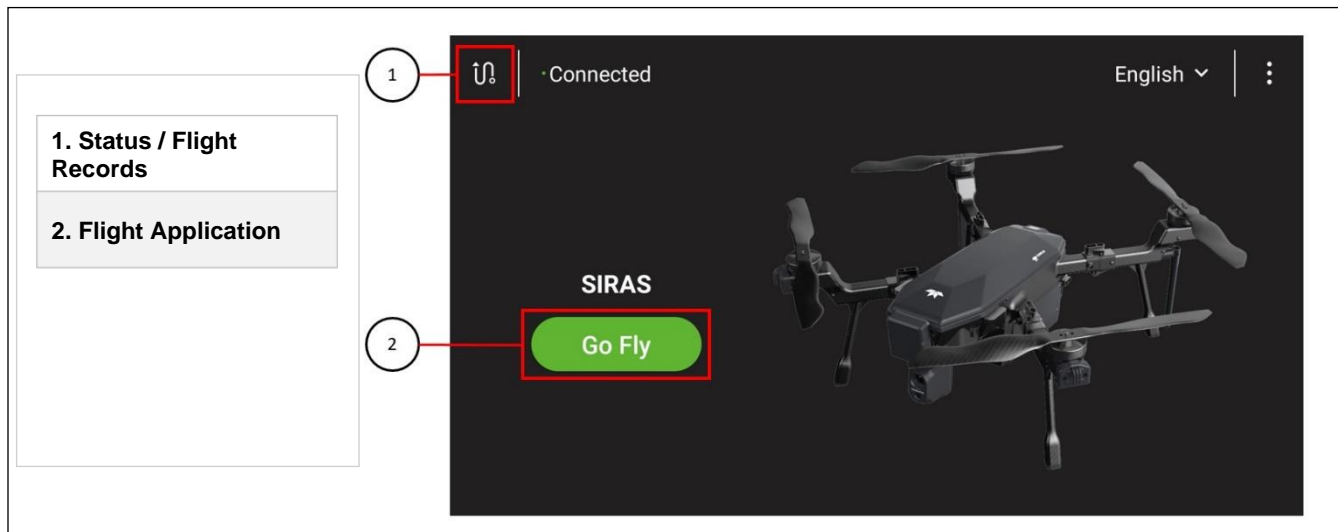



FIGURE 7.A SIRAS CONTROLLER HOME SCREEN

#### A1. Overall Status / Flight Records

To review flight status and records, tap the (  ) icon in the upper left corner of the home screen. This brings up the Overall Status and Flight Record pages ([Figure 7.B](#); Flight Record shown). The Overall Status page will display error lists (if any) from recent flights to help pilots diagnose issues with the aircraft. For example, if low remaining battery levels trigger the automatic Return to Home feature, a record of this event will appear.

The Flight Record page displays data from recent flights.



Overall Status		Flight Record				
Flight Record	2022-11-15	2022-11-15	Search			
Drone	Date	Takeoff Time	Landing Time	Distance	Time	Result
Drone	2022/09/20	23:14:16	23:14:23	0.0 ft	7 Sec	OK
Drone	2022/09/20	23:14:25	23:14:28	0.0 ft	2 Sec	OK
Drone	2022/09/20	23:49:20	23:51:59	185.1 ft	159 Sec	OK
Drone	2022/09/20	23:52:28	23:53:28	301.4 ft	59 Sec	OK
Drone	2022/09/20	23:53:57	23:55:36	68.9 ft	99 Sec	OK
Drone	2022/09/20	23:56:22	23:57:10	27.6 ft	48 Sec	OK
Drone	2022/09/20	23:57:16	23:58:05	212.1 ft	58 Sec	OK

FIGURE 7.B FLIGHT RECORD SCREEN

Touch the screen and slide up or down to scroll through records. Tap on a flight record to have the controller display a flight map.

## A2. Go Fly Application

Tap the Go Fly button to launch the flight control screen ([Figure 7.C](#)).

## B. Go Fly Application Features

Tapping the Go Fly button on the Home Screen brings up the Go Fly App Flight Control Screen ([Figure 7.C](#)).



FIGURE 7.C GO FLY APP FLIGHT CONTROL SCREEN

TABLE 7.A GO FLY APP FEATURES

Item	Description
1. Home	Display the Home Screen (as shown in <a href="#">Figure 7.A</a> )
2. Manual or Waypoint	Flight Type: Either manual or executing a mission ( <a href="#">7.B2</a> )
3. Status Indicators	GPS, compass, and other status indicators ( <a href="#">7.B3</a> ) (Red icons are shown for illustration only; they are not normally present in flight)
4 Flight Mode / Preflight Readiness	Attitude (ATT), Position (GPS), or Sport (Sport); tap for preflight check ( <a href="#">7.B4</a> )
5. Signal and Battery Levels	Signal strength between controller and aircraft; battery levels ( <a href="#">7.B5</a> )
6. Controller Configuration	Controller mode and threshold settings ( <a href="#">7.B6</a> )
7. Camera Viewing Mode	Thermal, Visible, or MSX®; display resolution and modes ( <a href="#">7.B7</a> )
8. Photo/Video Selection and Settings	Photo modes: still or video, with related settings ( <a href="#">7.B8</a> )

Item	Description
<b>9. Map Mode Switch</b>	Toggles display between image and map ( <a href="#">Q</a> )
<b>10. Telemetry</b>	Attitude and heading, height, distance from the start, horizontal and vertical speed, and time remaining ( <a href="#">7.B10</a> )
<b>11. Payload Angle</b>	Camera direction ( <a href="#">7.B11</a> )
<b>12. Collision Avoidance</b>	Toggles the anti-collision feature ( <a href="#">7.B12</a> )

**B1. Home Screen**

Select the Home Screen icon to return the controller display to the home screen, as seen in [Figure 7.A](#).





**B2. Manual or Waypoint**

Displays which type of flight mode has been selected. “Manual” indicates that the controller’s Mission switch is set to OFF; Waypoint indicates ON. See the details on planning and flying a mission in [8.P](#).

**B3. Connection Status and Error Indicators**

Several icons can appear in this part of the screen, as described in [Table 7.B](#).

**TABLE 7.B CONNECTION STATUS AND ERROR INDICATORS**

Icon	Meaning
	<b>GPS satellites:</b> This icon is always displayed. It indicates the number of satellites the drone is communicating with. This number will fluctuate throughout the flight.
	<b>GPS connection lost:</b> If the number of connected satellites drops below 14, this GPS error indicator will be displayed. <i>See the warning below.</i>
	<b>microSD card missing:</b> No microSD card is installed in the controller. This card is not required for flight, but its absence reduces the amount of image storage available on the controller.
	<b>Compass not calibrated:</b> Either the compass was not calibrated before flight, or calibration has been lost. <i>See the warning below.</i>
	<b>Noisy environment:</b> There is too much interference in the area for the compass to be calibrated.
<b>(gauge)</b>	<b>Diagnostic:</b> The red gauge is a diagnostic indicator to aid service technicians and can be ignored by pilots.



- 
- ⚠ **If you lose GPS, try moving to a more open location, e.g., away from tall buildings. Without GPS, only the Attitude flight mode is available, which requires extreme caution and pilot talent.**
  - ⚠ **If compass calibration is compromised during flight, the aircraft will switch to Attitude mode and display a warning. The aircraft will usually recover within a few seconds and automatically return to its prior GPS mode (Sport or Position). However, if it remains in Attitude mode, it is recommended that you land the aircraft and recalibrate the compass.**
- 

**B4. Flight Mode / Preflight Readiness**

This green box displays the flight mode the aircraft is operating in ATT for Attitude Mode (controller setting A), GPS for Position Mode (controller setting P), or Sport for Sport Mode (controller setting S). These flight modes are described in [8.H, Flight Modes \(A, P, and S\)](#).

Tap the Flight Mode green box to pull up the Preflight Check menu illustrated in [Figure 7.D](#).

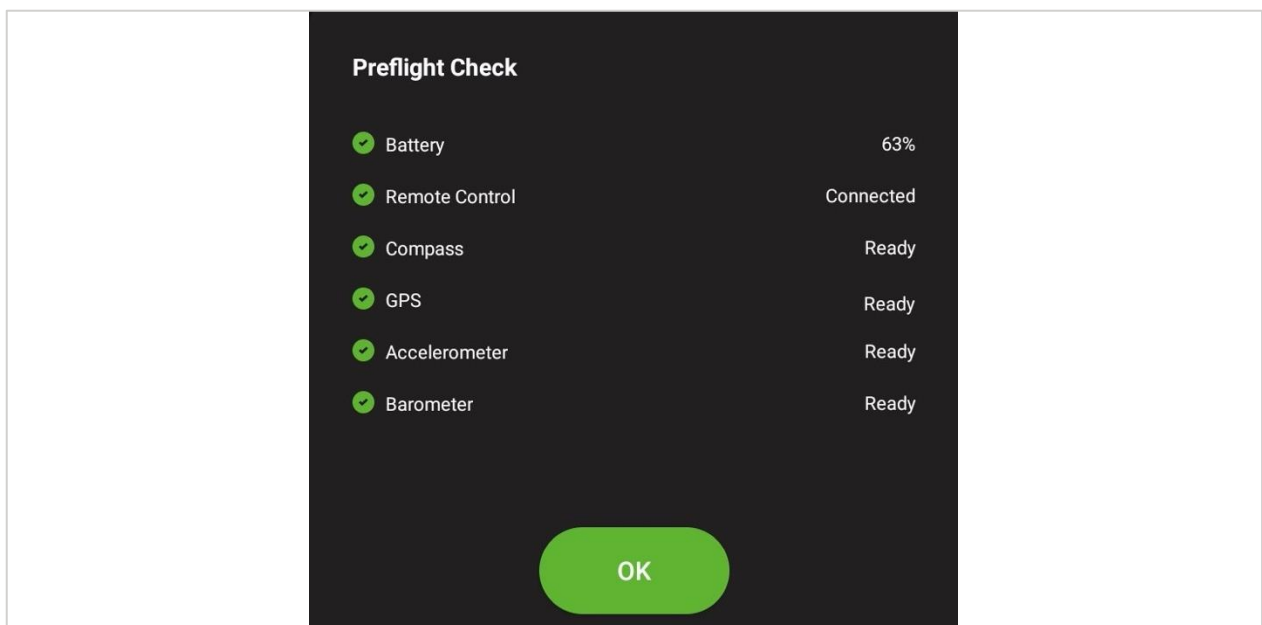

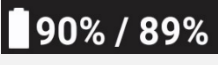

FIGURE 7.D PREFLIGHT CHECK / FLIGHT READINESS MENU

**B5. Controller and Aircraft Signal and Battery Levels**

Group 5 in [Figure 7.C](#) displays the signal and battery indicators, as described in the following table.

**TABLE 7.C SIGNAL AND BATTERY LEVELS**

Icon	Meaning
	<b>Signal strength:</b> Up to 3 bars, indicating the strength of the aircraft's radio signal at the controller
	<b>Controller battery charge level</b>
	<b>Aircraft battery charge levels:</b> See the warning below

**⚠ The two aircraft batteries should be charged to levels within 5% of each other. If they are not charged within 5% of each other, both batteries will wear more quickly, and aircraft performance could be diminished.**

## B6. Configuration of Controller Functions

Tap the (  ) icon in the upper right corner for Safety, Control, Camera, and About settings and features.

### B6i. Safety Menu

The Safety menu enables the pilot to set and monitor critical safety operations of the aircraft. The menu is large and extends beyond the edge of the display screen. Use the touchscreen to drag the menu upward and view the lower half.

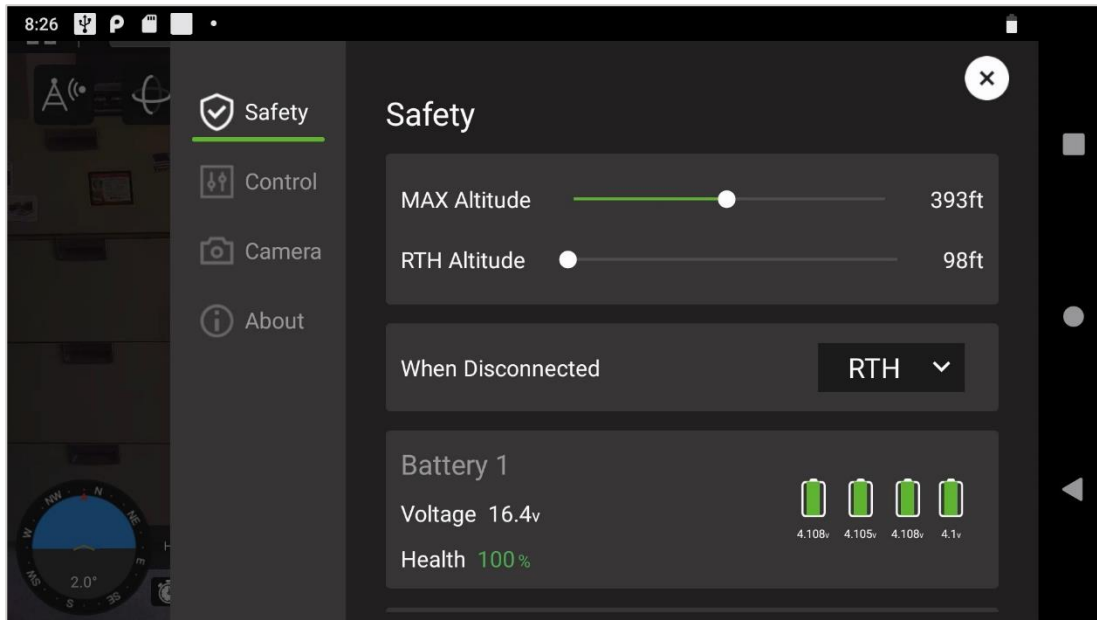
**FIGURE 7.E SAFETY MENU (PART 1)**

**MAX Altitude:** Use the sliding bar to set the maximum altitude warning value of up to 700 ft (210 m) above takeoff altitude.

**⚠ The height restrictions for drone flights are different in every country/region. Contact the local aviation supervising authority to confirm the actual height restrictions. Typical limits are 400 ft or 120 meters. Set the warning level no higher than the legal limit unless you have special permission to fly above that height.**

**RTH Altitude:** Use the provided sliding bar to set the altitude the aircraft will move to (unless it is already above that altitude) when the Return to Home feature is engaged. Note that collision avoidance is automatically turned on when the Return to Home feature is engaged.

**When Disconnected:** This tells the aircraft what to do if the connection to the controller is lost. The options are RTH (Return to Home), Hover, and Land.

**Battery Health:** Battery Health indicates how much of the original charging capacity of the battery remains. Over time the maximum achievable charge upon recharging declines. Use this as an indicator of when to purchase new batteries. With normal use, the batteries should retain 90%+ of the original capacity through at least 200 recharging cycles.

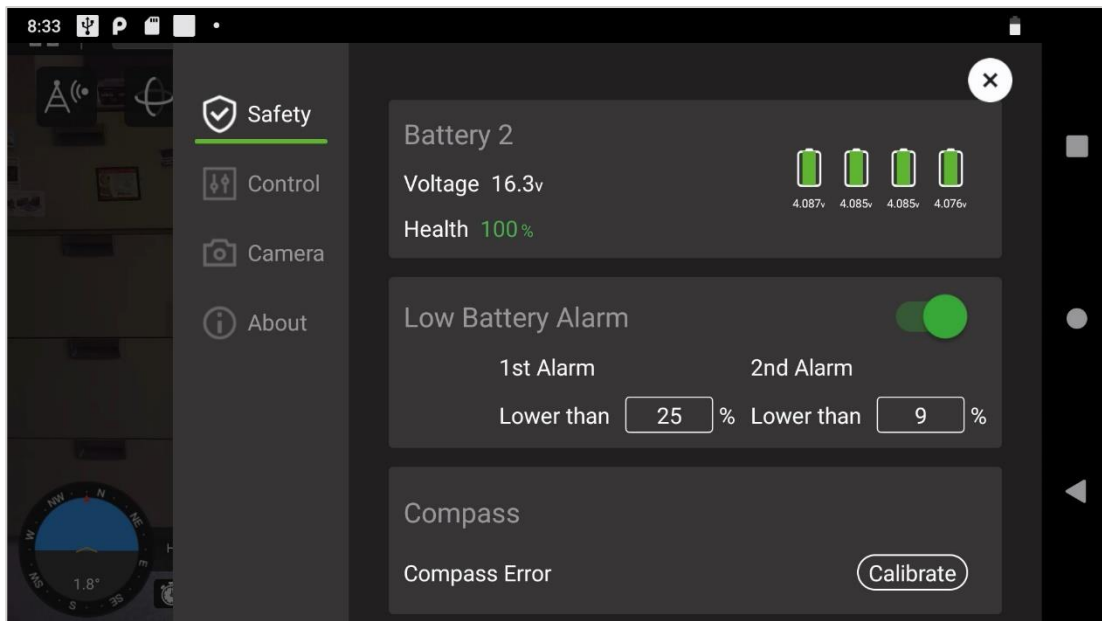

FIGURE 7.F SAFETY MENU (PART 2; SCROLL DOWN TO VIEW)

**Low Battery Alarms:** The SIRAS aircraft will emit audible alarms when a battery's charge drops below specified levels during flight. Set these levels by tapping the green status dot in the menu. Slider bars for the first and second alarms will appear.

**ⓘ When 10% battery charge is remaining, SIRAS will automatically return to home.**

**Compass Status and Calibration:** Use this section of the Safety menu to ensure that the aircraft compass is calibrated and functioning and to recalibrate the compass if it is not. Recalibrating the compass is recommended each time SIRAS is flown at a different location in urban areas prone to magnetic interference. See [8.A](#) for instructions on calibrating the compass.

**B6ii. Control Menu**

The Control Menu enables the pilot to adjust various settings of the remote controller:

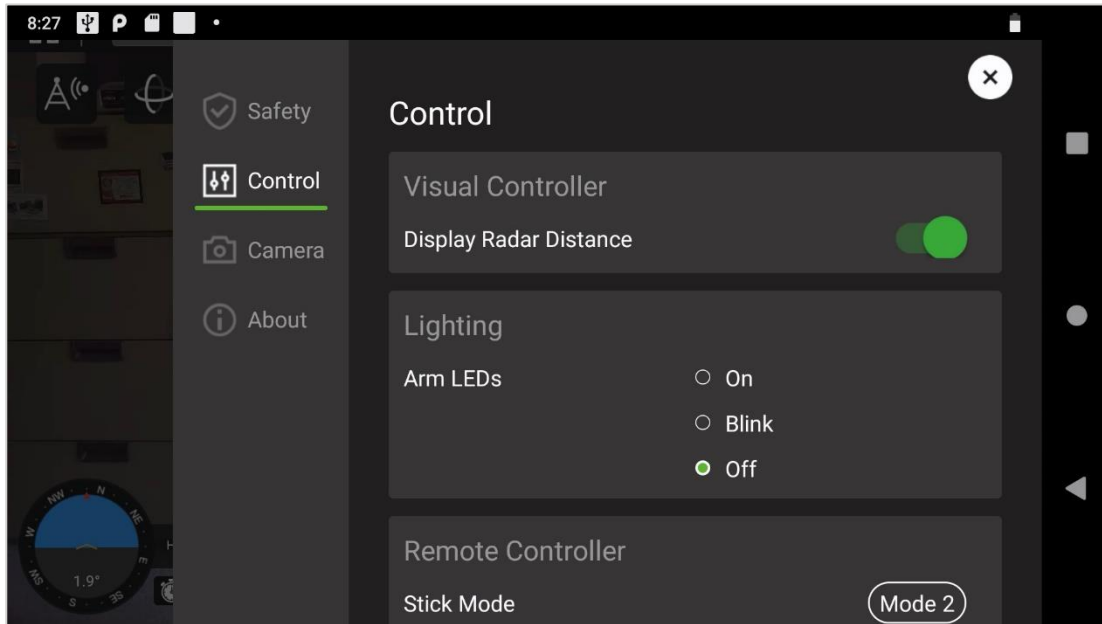

FIGURE 7.G CONTROL MENU (PART 1)

**Display Radar Distance:** This is an on/off feature that displays the distance from the aircraft to an object ahead of the aircraft when the radar collision avoidance system is turned on.

**Arm LEDs:** Turn the LED lights on the four aircraft arms to on, blink, or off modes.

**Stick Mode:** Set the joystick mode. Mode 2 is the default setting, in which the right stick controls roll and pitch while the left stick controls yaw and up/down motion (throttle). See [8-J, Manual Joystick Operation](#). Mode 1 is also available.

**Pair Remote Controller** ([Figure 7.H](#)): Pairing is pre-established by the manufacturer and does not need to be redone under normal circumstances. However, some pilots may purchase a second controller for extended flight days, in which case pairing will be required.

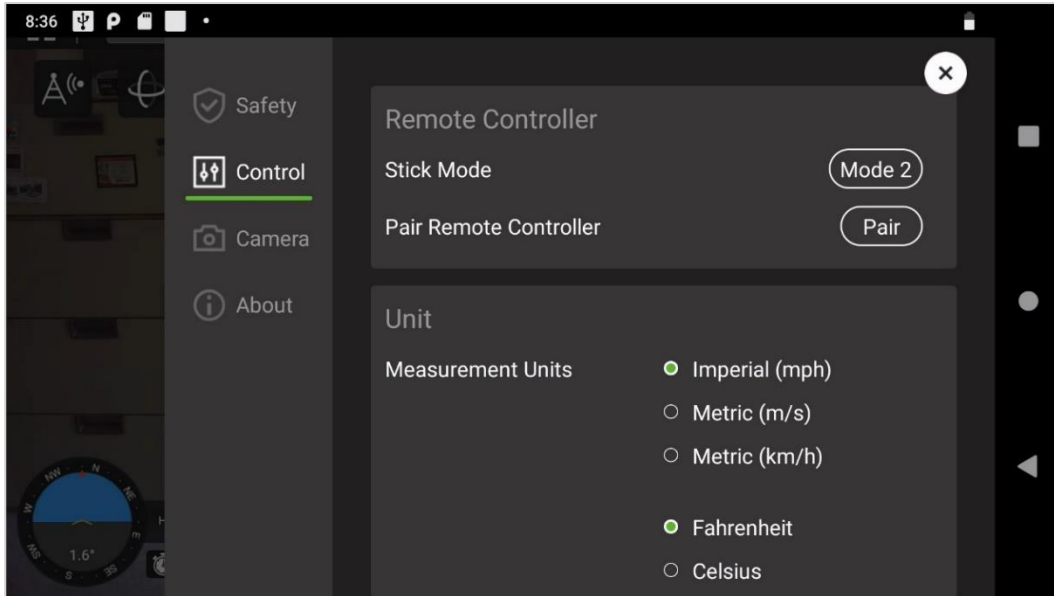

FIGURE 7.H CONTROL MENU (PART 2, SCROLL DOWN TO VIEW)

To pair the controller with the aircraft, do the following:

1. Invert the aircraft and remove the plug covering the Pairing button ([Figure 7.I](#)).

---

 **Avoid bending the propellers.**

---



FIGURE 7.I PAIRING BUTTON COVER

2. Power the aircraft on.
3. Bring the controller near the aircraft to be paired and extend the controller's antenna.
4. Power the controller on and go to the Control Menu, as shown in [Figure 7.H](#).
5. Tap Pair in the Control Menu.

6. Follow the on-screen directions, tapping Next to advance.
7. Insert a paper clip into the pair button, as shown in [Figure 7.J](#). Hold down the Pair button on the SIRAS aircraft until the Pair Indicator underneath the SIRAS flashes red.



FIGURE 7.J PRESSING THE PAIR BUTTON (PAIRING LIGHT FLASHING)

8. In the next dialog (Step 3), tap Remote Controller Pairing, as shown in [Figure 7.K](#).

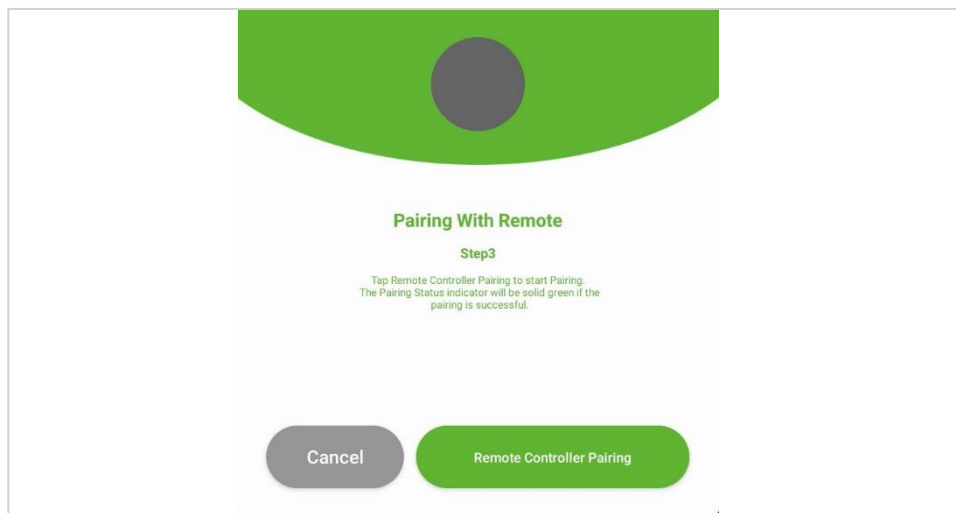

FIGURE 7.K PAIRING, STEP 3

9. After about 15 seconds, the controller will indicate either that pairing was successful or that it has failed. On the aircraft, the pairing indicator LED will turn blue if pairing was successful or red if pairing failed.

**Unit Settings:** (Figure 7.H, above) This menu enables the choice of English or Metric units for speed, distance, and temperature.

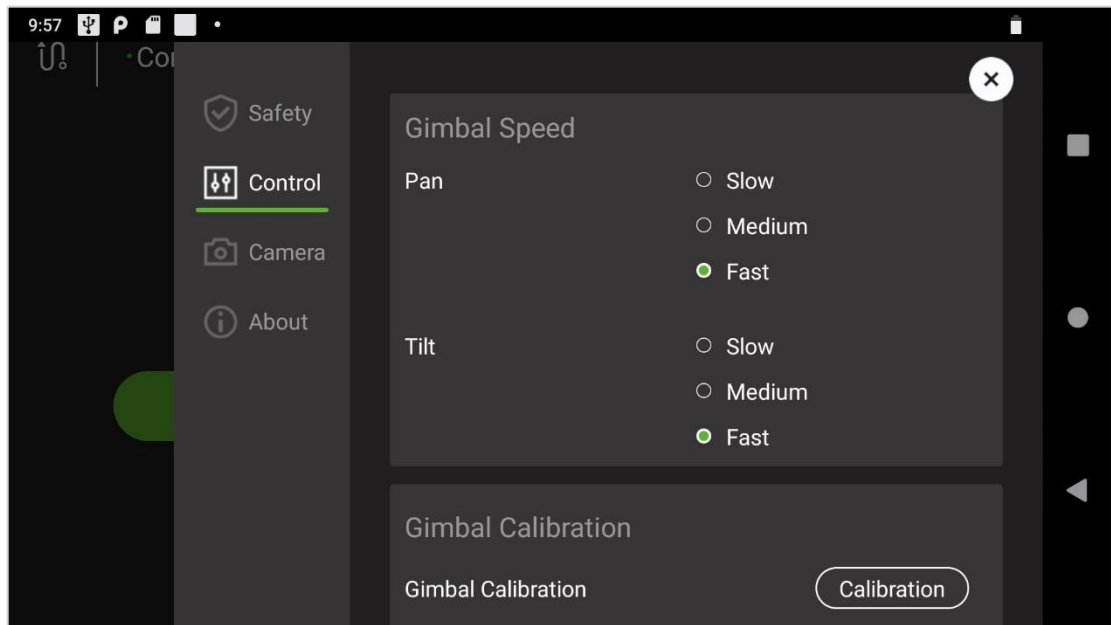

FIGURE 7.L CONTROL MENU (PART 3, SCROLL DOWN TO VIEW)

**Gimbal Speed:** This menu enables adjustment of the gimbal pan and tilt speeds. The default setting is Medium. Use the Slow setting with camera zoom functions to give the most stable and smooth video and enable easier target tracking.

**Gimbal Calibration:** Tap the Calibration to initiate gimbal calibration, which ensures that the gimbal can properly orient itself.



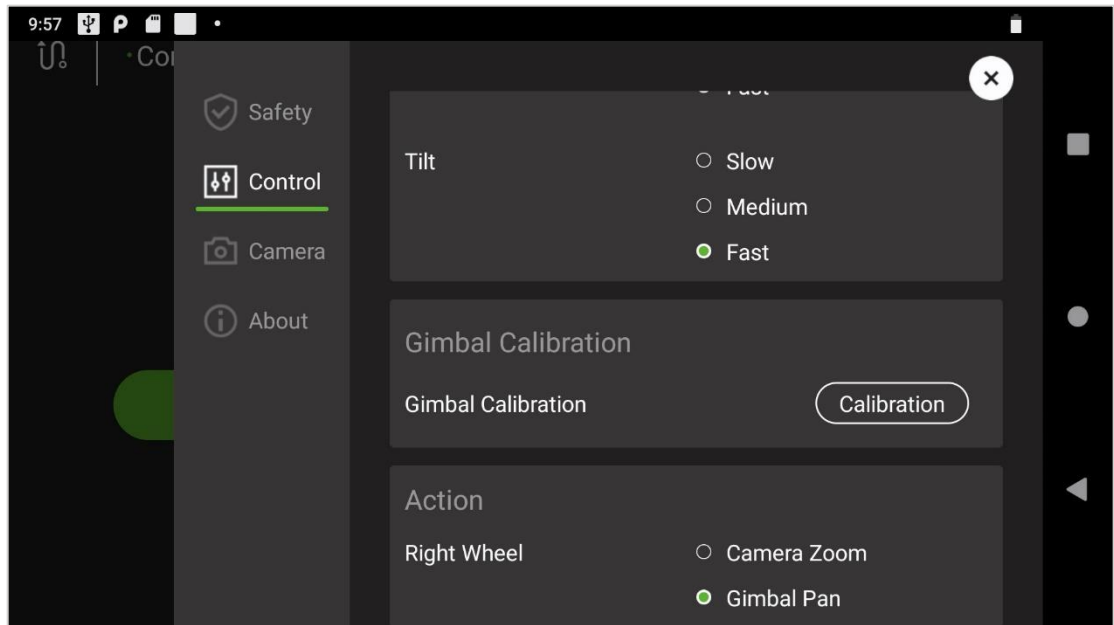

FIGURE 7.M CONTROL MENU (PART 4, SCROLL DOWN TO VIEW)

**Action:** Action determines what the right wheel on the controller does. The right wheel is operated by pressing it down, rolling it in one direction or the other, and letting go. Select “Camera Zoom” or Gimbal Pan. The operation of the right wheel is described in [8.K2](#).

---

**ⓘ The left wheel cannot be remapped; it always controls the gimbal tilt.**

---

### B6iii. Camera Menu

The Camera Menu enables the adjustment of several features related to image recording and appearance.

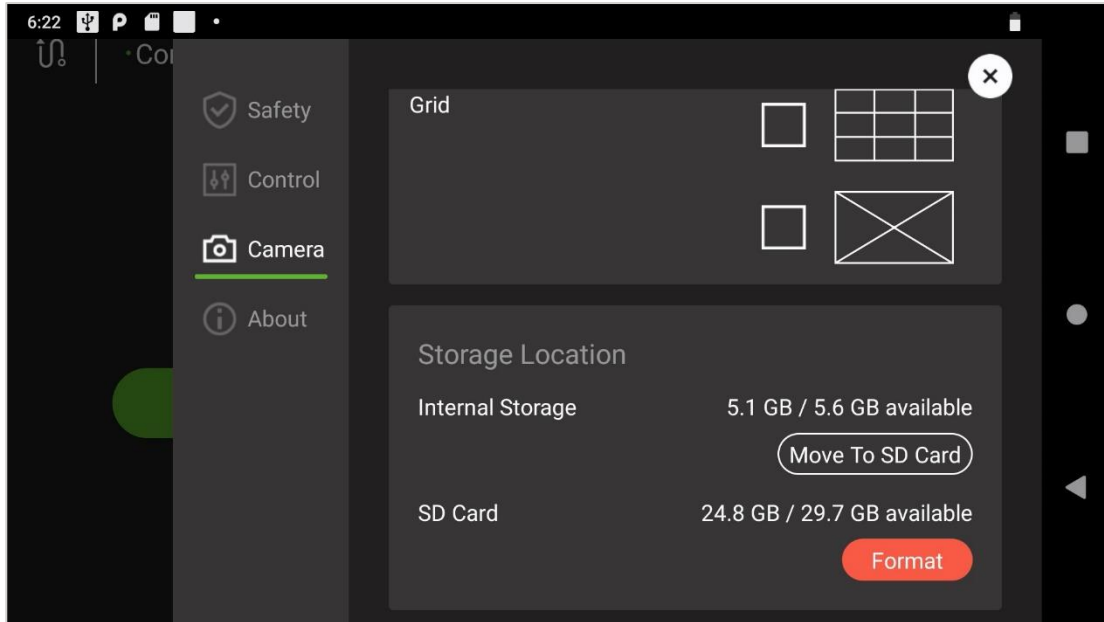

FIGURE 7.N CAMERA MENU

**Grid:** Two grid styles can be superimposed onto the display screen and any recorded images or video. Select the desired grid by checking the box next to it, or leave both options unchecked for no grid overlay.

**Storage Location:** This shows the memory usage for the controller’s internal memory and the microSD card. For example, the wording “5.1 GB / 5.6 GB available” indicates that 5.1 GB of memory is *free* out of a total *capacity* of 5.6 GB, i.e., 0.5 GB is in use.

Low-resolution images obtained by the controller are stored on the controller’s microSD card unless no card is inserted, in which case images are stored in the controller’s internal storage. To move images from internal storage to the SD card, tap the Move to SD Card button.

The Format (  ) button reformats the microSD card.

---

 **Retrieve any useful data from the microSD card before reformatting it.**

---

### B6iv. About Menu

This menu includes the Flight App name, version, and the most recent firmware versions/updates loaded onto the controller. If the aircraft’s software is out-of-date relative to the controller software, this box will display an Update button (see Chapter 9, [Updating the Controller and Aircraft Firmware](#)).

**B7. Viewing Mode Selection and Settings**

The features in Group 7 of [Figure 7.C](#) enable switching between the visible camera (V), the thermal camera (T), and Teledyne FLIR's patented MSX® mode (M).

Other icons in this group enable manipulation of the cameras and their performance, including the zoom functions for the thermal and visible cameras and the radiometric spot meter and color palettes for the thermal camera. These features work in conjunction with a choice of still image or video modes selected by the Shutter Controls (Group 8 of [Figure 7.C](#)).

The features in this group vary depending on the camera mode selection: M, T, or V.











**B7i. Visible Camera (V)**

When the V (visible) icon is selected, icons appear to its left, as shown in [Figure 7.O](#). These are described in [Table 7.D](#).



FIGURE 7.O VISIBLE CAMERA QUICK-ACCESS FEATURES

**TABLE 7.D VISIBLE CAMERA QUICK-ACCESS FEATURES**



VISIBLE ICON	FUNCTION	NOTES
	Zoom Level	Still Camera  + HD  only: x1, ... x128
 or  /  / 	Streaming Rate (still camera) or Resolution +Frame Rate (video)	Still Camera  : <ul style="list-style-type: none"> <li>• Regular (8MP)</li> <li>• HD (16MP)</li> </ul> Video  : <ul style="list-style-type: none"> <li>• 4k / 30 fps</li> <li>• 1080 / 50 fps</li> <li>• 1080 / 100 fps</li> </ul>
	Exposure Compensation Value	-2 (darkest) -1 0 1 2 (lightest)

**Zoom:** The Zoom Level icon displays the current zoom. The Zoom Level can change from x1 only in Still Camera + HD mode. Tapping the Zoom icon displays available Zoom Levels and selection.

- ❗ **The Zoom Level icon is disabled if the Zoom function is assigned to the controller's right wheel (see the [Action](#) paragraph in [7.B6ii](#)).**
- ❗ **Zooming via the icon will toggle HD ON in Still Image mode.**

**HD (High Definition):** This icon () appears only in Still Image mode. When selected, the camera uses HD resolution. If you clear HD, the Zoom level reverts to x1.

- ❗ **Only use HD mode when the aircraft is stationary, or you may observe pixilation and increased image latency on the controller display.**

**Resolution + Frame Rate:** This icon (  ,  , or  ) **only** appears in Video mode. Tap it to select a combination of video resolution and frame rate. This allows you to make a tradeoff between video fidelity and file size. [Figure 7.P](#) highlights this icon and the other icons that enable it.

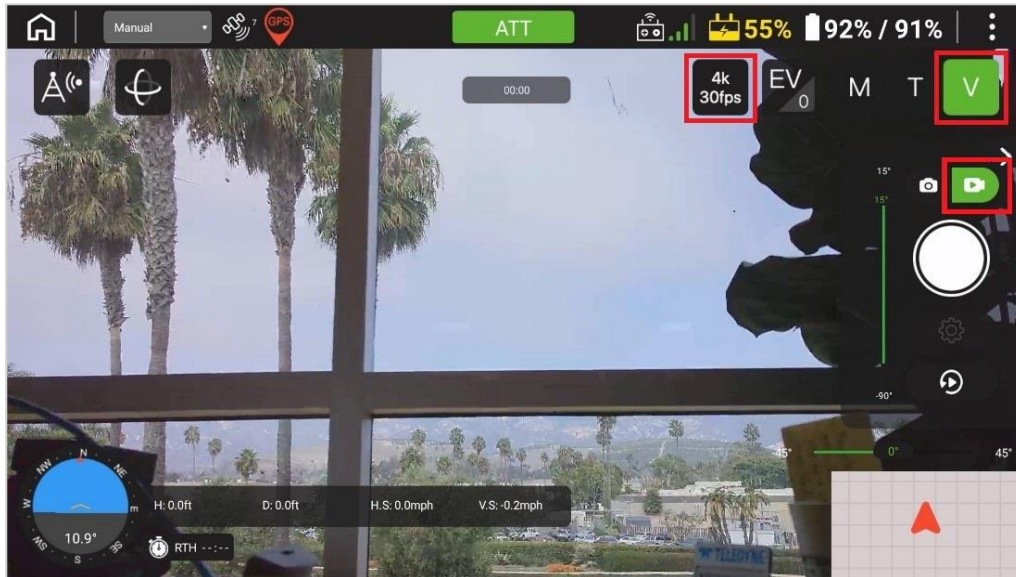



FIGURE 7.P THE VIDEO RESOLUTION ICON (VISIBLE LIGHT / VIDEO)

**Exposure Value:** This icon (  ) enables adjustment of the scene brightness. The brightness level is displayed as a subscript on the EV icon. Brightness can be adjusted on a scale from -2 (darker) to +2 (brighter) to prevent imagery from being too dark or too light.

**B7ii. Thermal Camera (T)**

When the T (thermal) icon is selected, icons appear to its left, as shown in [Figure 7.Q](#). These are described in [Table 7.E](#).

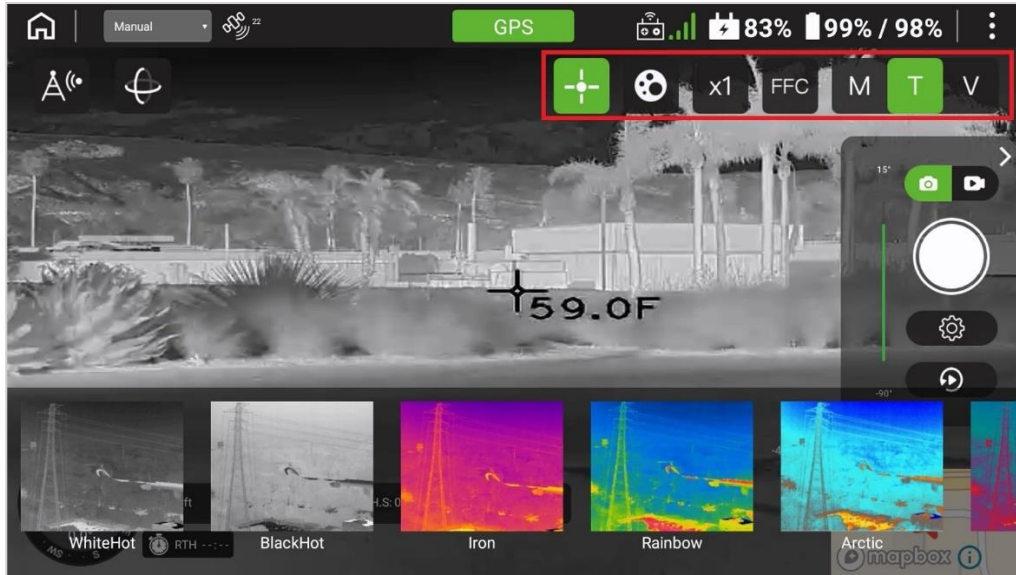





FIGURE 7.Q THERMAL CAMERA QUICK-ACCESS FEATURES

TABLE 7.E THERMAL CAMERA QUICK-ACCESS FEATURES

THERMAL ICON	FUNCTION	NOTES
	Radiometric Spot Meter	Display temperature at crosshairs (green: Radiometric Spot Meter is active)
	Show Thermal Color Palettes	Some palettes are shown in <a href="#">Figure 7.Q</a> . This icon is a toggle; it does not highlight
	Zoom Level	x1, x2.5, or x5
	Flat Field Correction	Performed immediately

- i** The Zoom Level icon is disabled if the Zoom function is assigned to the controller's right wheel (see the right wheel assignment paragraph in [7.B6ii](#)). Note that additional thermal camera features are accessed via the Gear icon (  ) below the Shutter button and are described in detail in [7.B8iii](#).

**B7iii. Split Screen (T plus V)**

To enable the visible and thermal split screen mode, engage either the thermal T or visible V icon, then touch and hold down the other T or V icon so that both are illuminated.

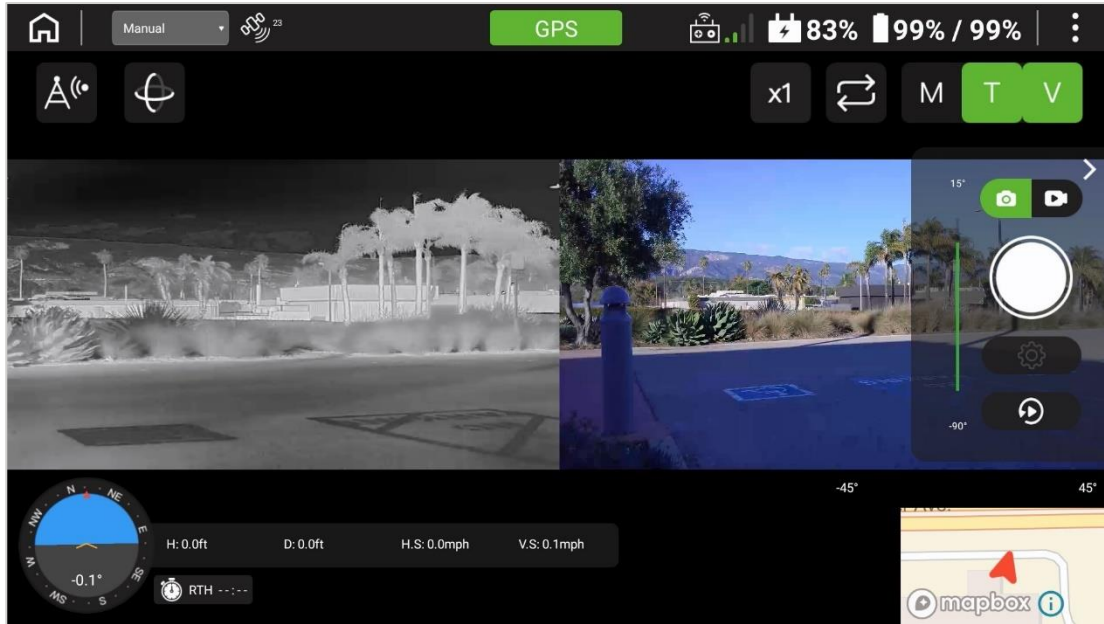

FIGURE 7.R THERMAL PLUS VISUAL DISPLAY

**B7iv. MSX (M)**

MSX takes edge and other effects from the visible image or video and overlays it onto the thermal image, providing more detail and context. Use this mode to read labels and define visible-light details on the thermal image when lighting permits.

When MSX mode is selected, the controller displays both the thermal and visual images (as in [Figure 7.R](#), except with M highlighted rather than T and V). To see the effect of MSX mode, use the

Still Camera (  ) and press the Shutter (  ) to store a snapshot onto the controller's microSD card. View the photo by tapping Replay (  ). An example of an MSX image is shown in [Figure 7.S](#).

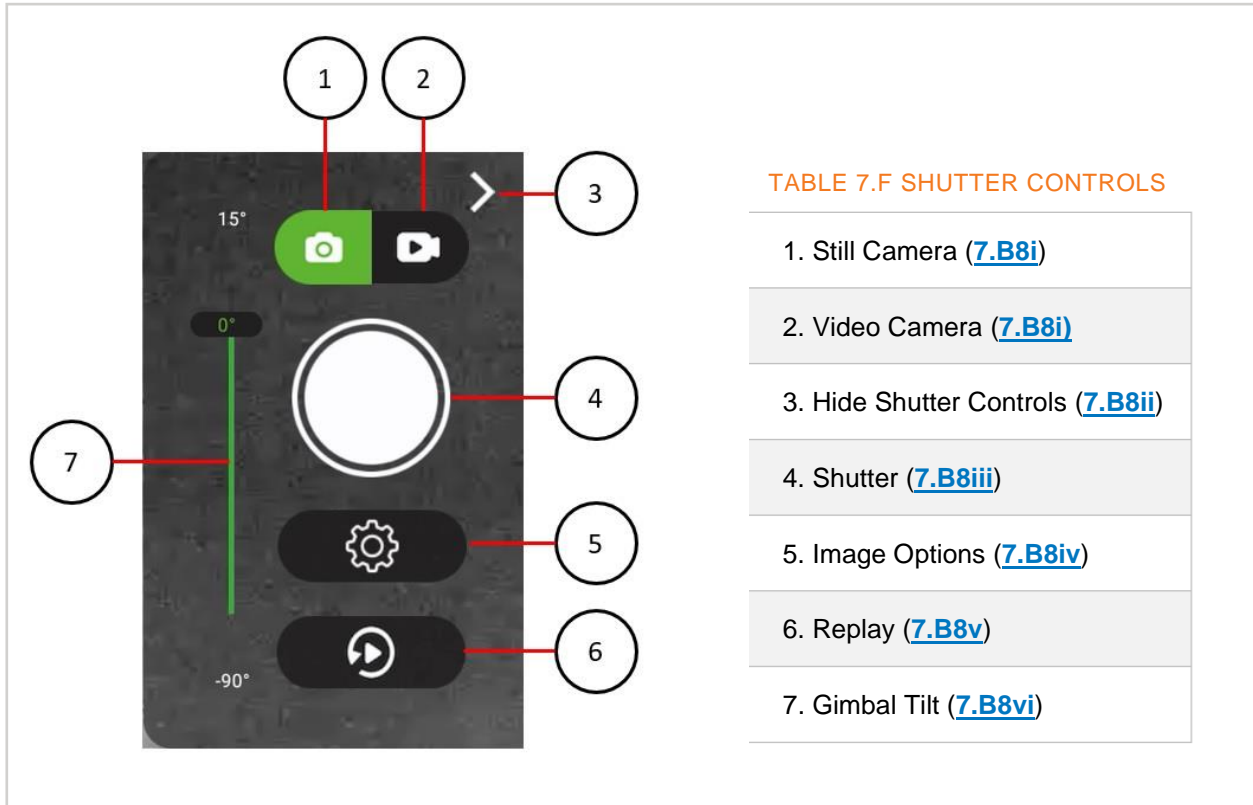

FIGURE 7.S MSX MODE (OUTLINED THERMAL) PHOTO



**B8. Photo / Video Selection and Settings (Shutter Controls)**

Various controls (Still Camera / Video, Shutter, etc.) are found on the right side of the controller display.





**TABLE 7.F SHUTTER CONTROLS**

1. Still Camera ( <a href="#">7.B8i</a> )
2. Video Camera ( <a href="#">7.B8i</a> )
3. Hide Shutter Controls ( <a href="#">7.B8ii</a> )
4. Shutter ( <a href="#">7.B8iii</a> )
5. Image Options ( <a href="#">7.B8iv</a> )
6. Replay ( <a href="#">7.B8v</a> )
7. Gimbal Tilt ( <a href="#">7.B8vi</a> )

FIGURE 7.T SHUTTER CONTROLS

**B8i. Still/Video Camera Icons**

The top pair of icons are the Still Camera (  ) and Video Camera (  ) icons. Whichever is highlighted in green is the current camera mode.

### **B8ii. Hide Shutter Controls**



You can hide the shutter controls by tapping on the right arrow (  ) at the upper right. Once hidden, the display appears as in [Figure 7.U](#). Restore the shutter control view by tapping on the left-pointing arrow at the right edge of the screen.



FIGURE 7.U BUTTON TO EXPOSE HIDDEN SHUTTER CONTROLS

### **B8iii. Camera Shutter Icon**

Tap the large white Shutter (  ) to capture a still image or video. In video mode, the button will turn red (  ) to indicate that video capture is in progress. Tap the button again to stop recording. You can also take a picture or video by tapping the Capture button on the controller (See [Figure 4.A](#), item 11).

### **B8iv. Image Options Icon**

Below the Shutter button is an icon that depicts a gear (  ). This is the Image Options icon. It is displayed when either the thermal camera has been selected, or when the combination of visible camera and still image are selected. It will disappear when the combination of visible camera and video mode are selected, as there are no user-adjustable settings in that mode.

**Visible, Still Camera Image Options:** For the visible camera in still image mode, the Gear icon can be selected to change the capture mode (single shot, burst of shots, and shot intervals). It also allows you to select the image format, though currently, only JPEG is available (see [Figure 7.V](#)).



FIGURE 7.V CAPTURE MODE AND IMAGE FORMAT SETTINGS FOR VISIBLE CAMERA

**Thermal, Still Camera Image Options:** When using the thermal camera in still mode, the Image Options icon brings up various radiometric adjustments and features, as seen in [Figure 7.W](#).

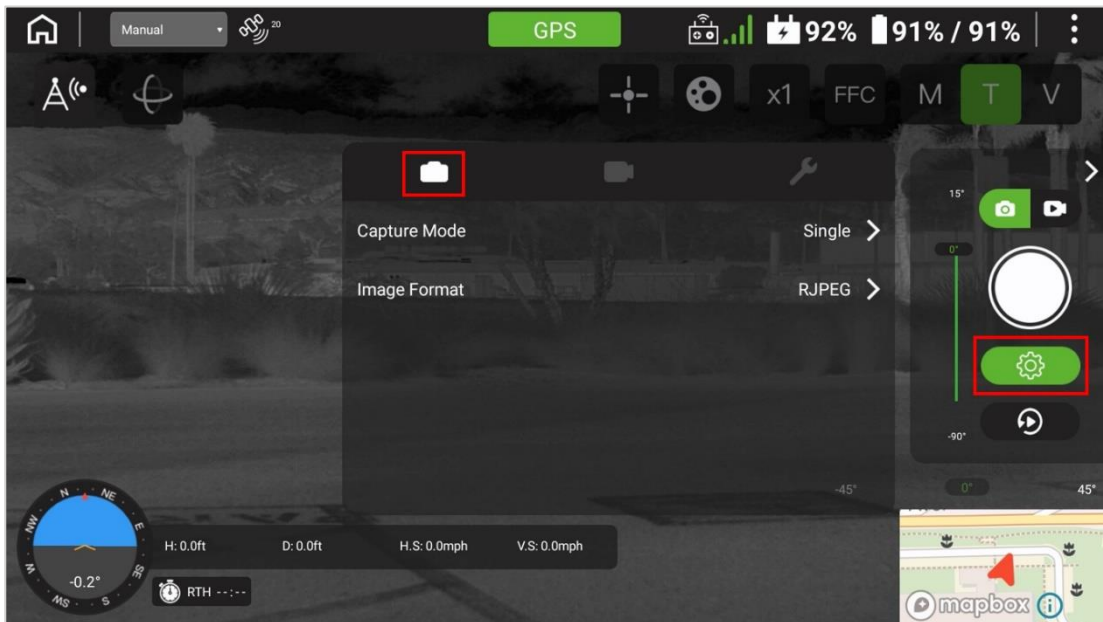



FIGURE 7.W CAPTURE MODE AND IMAGE FORMAT SETTINGS FOR THERMAL CAMERA

[Figure 7.W](#) shows the menu with the Camera icon highlighted (  ). This menu allows adjustment of the capture mode and image format. The available capture modes are single-shot, a burst of

several shots, or timed interval. In the timed interval mode, intervals between pictures range from one to thirty seconds.

This menu also lets you select the thermal image format, though only RJPEG is currently supported.

**Thermal, Video Camera Image Options:** Tap the Movie Camera icon (  ) to select the video format. Either MOV or CSQ (compressed sequence, 16-bit thermal data) are available.

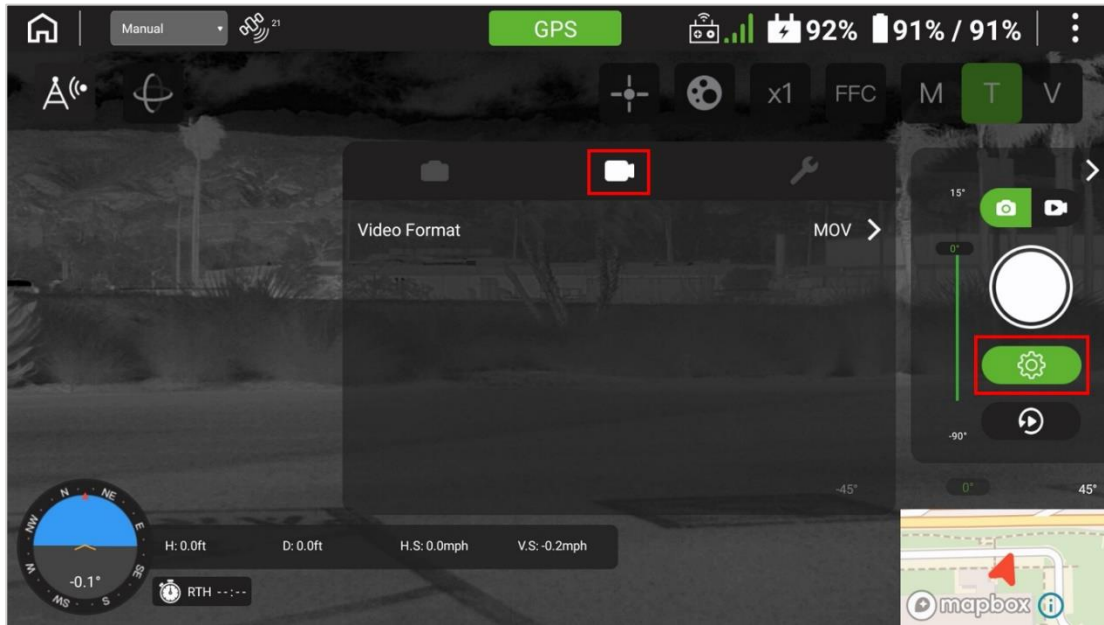

FIGURE 7.X VIDEO FORMAT SETTINGS FOR THERMAL CAMERA



**Thermography Parameters:** As shown in [Figure 7.Y](#), select the Wrench icon (  ) to adjust various thermography parameters. Available parameters include flat field correction (FFC) settings, automatic gain control (AGC) options, gain mode, use of a region of interest or measurement box (displays hottest, coldest, and average temperature within an area of interest), or to engage the isotherm functions. Within the isotherm function, the pilot can designate to highlight pixels representing temperature above or below a preselected temperature.



FIGURE 7.Y RADIOMETRIC ADJUSTMENTS FOR THERMAL CAMERA



**B8v. Replay Icon**

The Replay button (  ) enables viewing of what is saved on the controller's microSD card.

**B8vi. Gimbal Tilt Indicator**

The vertical green bar indicates gimbal tilt, where 15° is slightly above horizontal and -90° is straight down. Gimbal tilt is controlled by the left scroll wheel ( [8.K1](#) ) and by the Payload Angle icon ( [7.B11](#) ).

**B9. Map Mode Toggle**

Tap the area in the lower-right corner of the controller's display to bring up a flight map overlay of the local area, swapping the camera's image to the lower-right corner. Tap the same area to swap back. You can zoom in by two-fingered "stretching" on the map; zoom out by two-fingered "pinching." You can scroll by dragging the map with one finger, and center the map by touching the Center icon (  ). Switch to another map by tapping the Maps icon (  ).

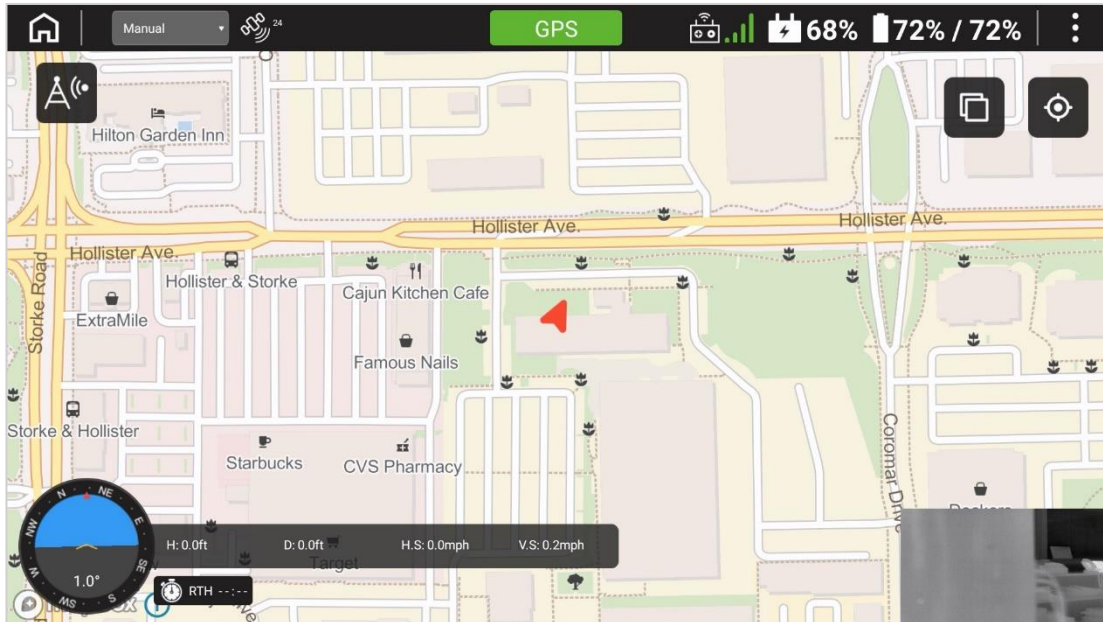

FIGURE 7.Z MAP ACTIVATED

See Chapter [0](#) for instructions on loading maps into the controller.

**B10. Flight Telemetry**

FIGURE 7.AA FLIGHT TELEMTRY

Displayed in the lower left corner is a circle describing aircraft attitude, as well as a compass heading on the outer circle, roll and pitch as an artificial horizon, and pitch in degrees. To its right is the horizontal bar

indicating the height from the ground (H), distance from the takeoff point (D), horizontal speed (HS), and ascending or descending vertical speed (VS). Below the bar is the Stopwatch icon displaying the estimated time remaining until the battery level reaches 10%, at which point the aircraft will automatically initiate a Return to Home.

---

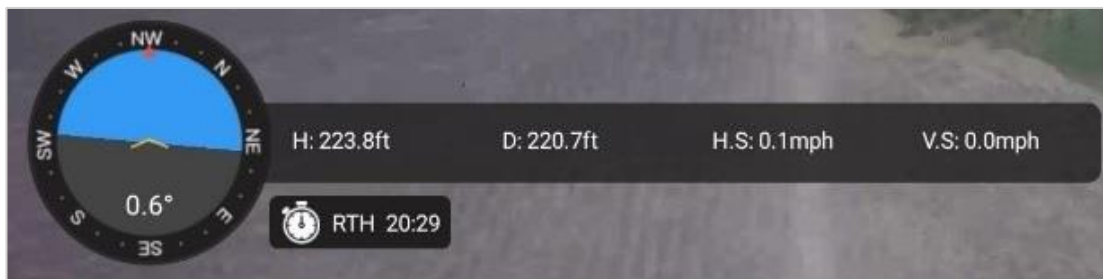
**⚠ The Return to Home time is merely an estimate; the pilot is responsible for returning the aircraft to a safe landing point with the battery power available, given the flight conditions.**

---

### B11. Payload Angle (Gimbal Tilt)

The Payload icon (  ) near the top left corner enables setting the tilt angle of the payload. Press the icon and two identical icons will appear. Press the lowermost icon to point the payload camera straight down (vertically). Press the second icon to aim the payload camera straight ahead (horizontally).

---

**☛ You can also control the payload angle (gimbal tilt) via the left scroll wheel (8.K1)**

---

### B12. Collision Avoidance

The Collision Avoidance icon (  ) also located near the top-left corner, enables engagement of the anti-collision feature. Its default setting is OFF. The collision avoidance feature is described in [8.M](#).

A large display message will pop up on the screen when Collision Avoidance is turned on, as seen in [Figure 7.BB](#).

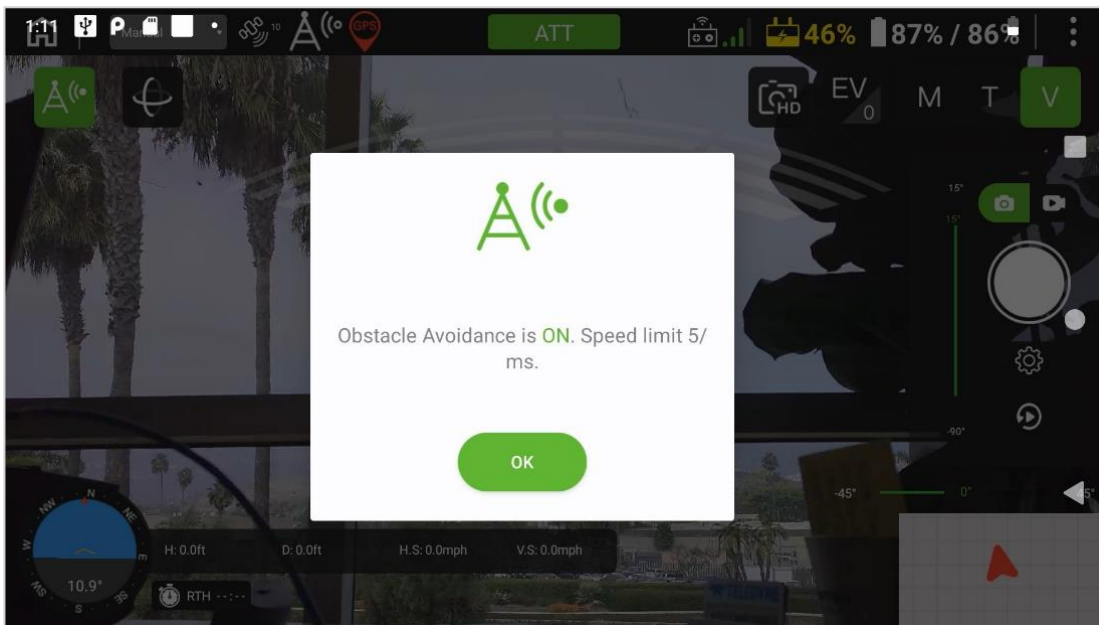

FIGURE 7.BB ENGAGEMENT OF THE COLLISION AVOIDANCE FEATURE

When the Collision Avoidance feature is active, the Collision Avoidance icon is highlighted green, and, if Display Radar Distance is set (7.B6ii) the screen will display arcs superimposed over the image (Figure 7.CC).

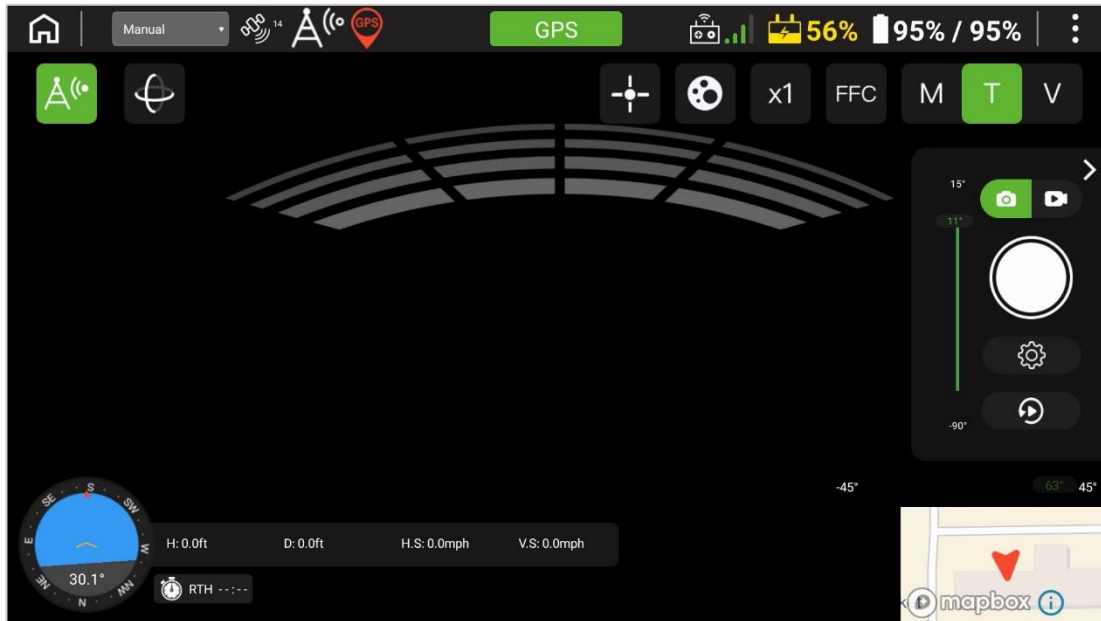

FIGURE 7.CC COLLISION AVOIDANCE ACTIVE

## C. MSX<sup>®</sup> Mode



MSX is a patented Teledyne FLIR imaging technology that produces richly-detailed thermal images by bringing together the visual and thermal spectrums. MSX uses a high-contrast visual image to emboss key aspects of the scene on top of a full thermal image. See 7.B7iv for instructions on how to activate MSX with SIRAS.



## 8. FLYING THE SIRAS AIRCRAFT

### A. Compass (Magnetometer) Calibration Procedure

The compass (magnetometer) should be calibrated before the first flight and recalibrated when the compass status indicators on the display screen indicate that it needs to be done (see Section [7.B3](#)). Compass error is also indicated in the Safety Menu, as shown in [Figure 7.F](#). Pilots flying in urban settings may find it helpful to recalibrate daily to minimize issues associated with electromagnetic interference caused by power lines, cellular towers, buildings with Wi-Fi networks, and metal (in concrete structures).

1. Move to an outdoor area away from large structures, metal structures, power lines, reinforced concrete, cars, metal fences, etc., that can cause magnetic disturbances.
2. Remove all ferromagnetic materials (such as keys or magnetic jewelry) from your person.
3. Stay away from electronic devices, such as mobile phones.
4. Start the calibration process from the controller by tapping the (  ) icon ([Figure 7.C](#), item 6) to access the Safety Menu (shown in [Figure 7.F](#)). Scroll down to access the Safety Menu and follow the on-screen prompts. Select the (  ) icon ([Figure 7.C](#), item 6) to access the Safety Menu and the Compass Calibration process at the bottom of the menu and tap (  ). Follow the on-screen prompts.
  - a. The first prompt directs the operator to hold the aircraft horizontally without moving it. After a few seconds, the second prompt will appear.
  - b. The second prompt ([Figure 8.A](#)) directs the operator to rotate the aircraft 360<sup>0</sup> while keeping it horizontal. This can be performed by physically rotating the aircraft around the operator's body, as shown in [Figure 8.B](#). Continue beyond 360<sup>0</sup> until the controller indicates that this step is complete.

---

 **Move smoothly and slowly.**

 **Hold the aircraft at least 3 ft (1m) above the ground to avoid ground-based interference.**

---

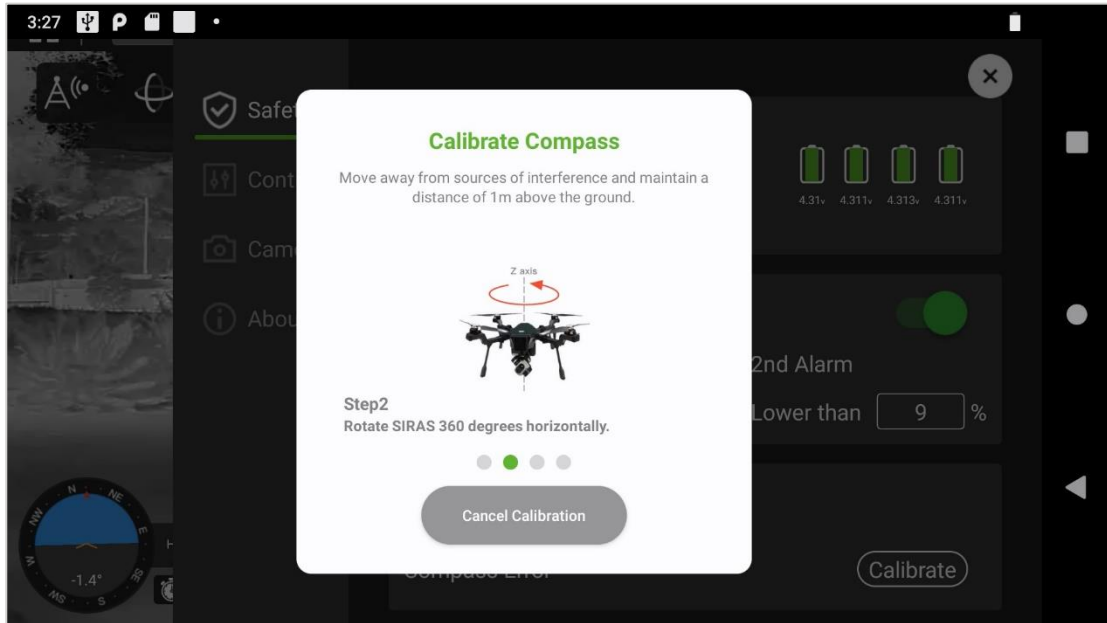

FIGURE 8.A CALIBRATE COMPASS: PROMPT 2



FIGURE 8.B COMPASS CALIBRATION STEP 2: HORIZONTAL ROTATION, LEVEL

- c. The third prompt directs the operator to hold the aircraft nose-up while rotating it 360° in the horizontal plane. Again, continue beyond 360° until the controller indicates that this step is complete.

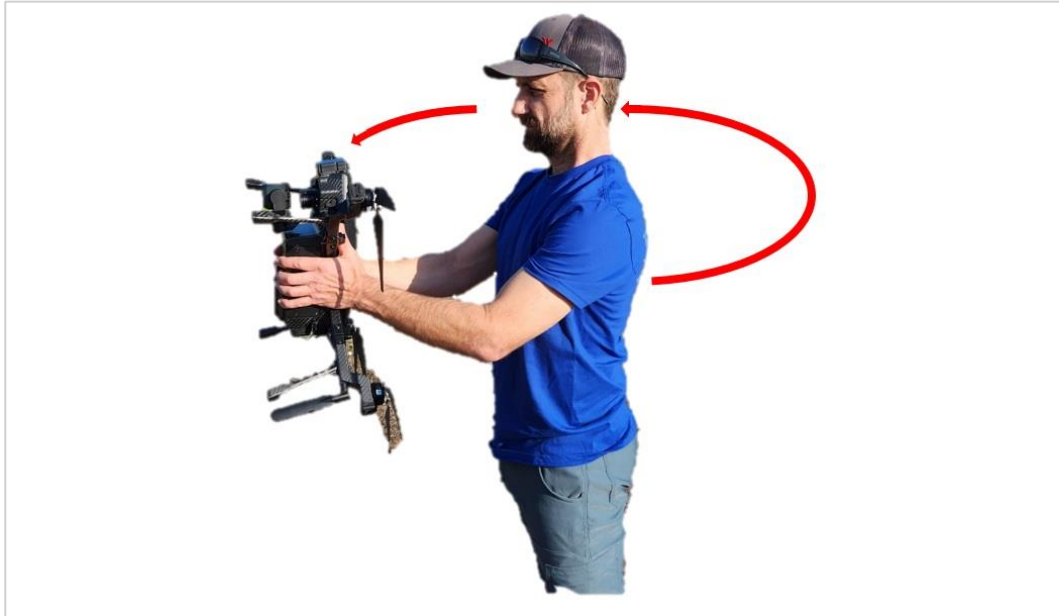

FIGURE 8.C COMPASS CALIBRATION STEP 3: HORIZONTAL ROTATION, NOSE-UP

- d. The fourth prompt directs the operator to hold the aircraft steady, nose up.

---

**ⓘ** **Pause with the nose up and without moving the aircraft, until the completion message appears on the controller's screen. Setting SIRAS down horizontally before receiving a completion message may cause the compass calibration to fail.**

---

5. The controller will indicate the quality of calibration. Excellent is shown in Figure 8.D. Other outcomes are Good, Poor, and Bad. A Bad rating indicates a failure.

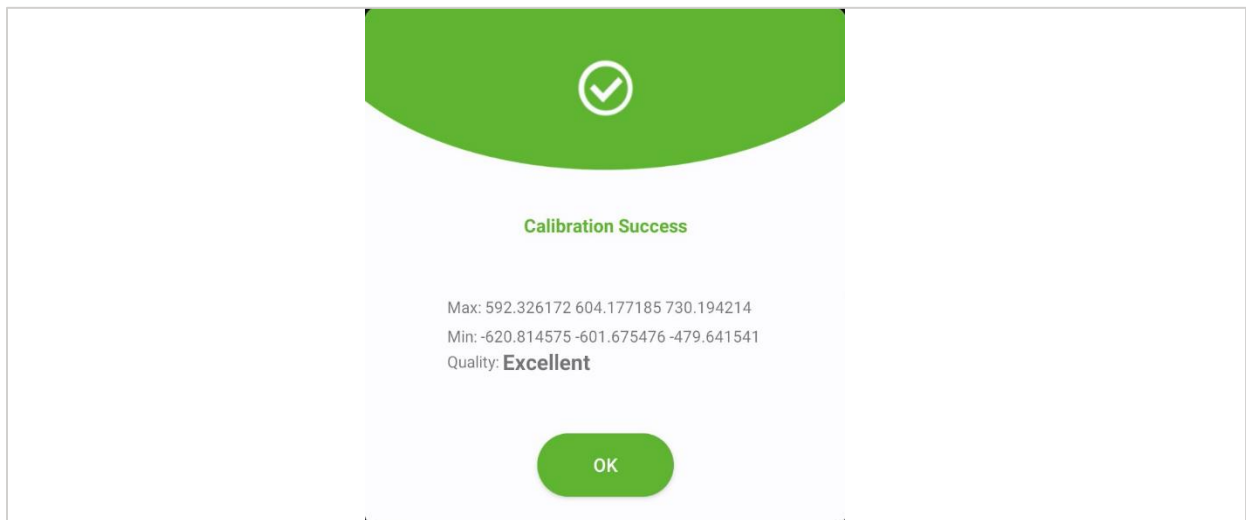

FIGURE 8.D COMPASS CALIBRATION SUCCESSFUL

- 
- ⚠ If a Poor or Bad rating message is displayed, move to a different location and recalibrate until a Good or Excellent rating is achieved.**
  - ⚠ It is possible to fly with a Poor compass calibration, but this entails a higher risk of dropping into Attitude mode during flight. This makes flying more difficult (see [8.H1](#)).**
  - ⚠ If compass calibration is compromised during flight, the aircraft will switch to Attitude mode and display a warning. The aircraft may recover and return to GPS mode automatically, but if it remains in Attitude mode, landing the aircraft and recalibrating the compass is recommended.**
- 

## **B. Precautions Before Flying**

Flight safety in accordance with applicable regulations is the responsibility of each professional pilot. Please read these precautions carefully before takeoff.

1. Perform preflight checks before every flight.
2. Before takeoff, make sure the batteries are fully charged.
3. Check the contact pins in the aircraft battery compartment. If they are bent, contact your service representative. Do not force the batteries into the aircraft.
4. Do not fly with only one battery. Doing so can damage the battery or the aircraft. See the warnings in [6.C1](#).
5. Do not hot swap batteries when the ambient temperature exceeds 37°C (100°F).
6. Be aware of and follow all applicable regulations regarding restricted airspace and other local flight practice regulations and laws. No-fly zones include but are not limited to airports, sites of significant events, emergency incidents (e.g., a forest fire), nuclear power stations, government buildings, prisons, military facilities, etc.
7. Height restrictions for drone flights are different in every country/region. Contact the local aviation supervising authority to confirm the actual height restrictions. If it is necessary to exceed the preset height limit in the SIRAS controller, the pilot should first read, understand, and accept the terms of the disclaimer before proceeding.
8. Do not fly under darkness or in bad weather conditions, such as strong wind (wind speed reaching 30 mph), snow, rainstorms, fog, sandstorms, tornados, or other weather that creates low visibility.
9. Use caution in areas with the potential for magnetic or radio wave interference. Be prepared for the aircraft to switch suddenly into Attitude Mode, which requires greater flying skill. Be prepared for a connection loss between the controller and the aircraft. If this happens, SIRAS will return to home (RTH) with Collision Avoidance enabled. To take SIRAS out of RTH mode once the connection has been restored (which usually

happens automatically once the aircraft is closer to its takeoff point), switch from the current flight mode to another (e.g., from Sport Mode to Position Mode) and turn off Collision Avoidance. This will return control of the aircraft to the pilot.

10. Keep the aircraft within your line of sight so that you can see and avoid other air traffic and maintain an appropriate distance from obstacles.
11. Do not fly above crowds or beyond the visual line of sight (BVLOS) without appropriate waivers.
12. Avoid flying low over the water. Maintain an altitude of more than 3 m (10 ft) above the water's surface to avoid spurious altitude indications from the onboard optical flow altitude sensors.
13. Taking off from a moving object, such as a moving boat or vehicle, is highly discouraged and should only be attempted by experienced professional pilots.
14. The pilot is legally liable for damages or injury caused by the negligent operation of the aircraft.
15. After a fire, explosion, earthquake, flood, lightning strike, or other disasters, ensure safety at the takeoff and landing points and be observant as the situation changes. Attend to your safety as well.

## C. Preflight Check

- Is the **controller Flight Mode Switch** set to P?

---

**⚠ Do not take off in modes A or S. A (Attitude) does not offer enough control over the aircraft in close quarters. Similarly, S (Sport) allows sudden speed changes, and is therefore unsafe for takeoff.**

---

- Is the **controller battery** fully charged?
- Are the **aircraft batteries** charged sufficiently for your flight plan, at charge levels within 5% of each other, and locked in place?
- Are the **controller antennas** extended?
- Are the **propellers** extended?
- Are the **propellers** secure?
- Are the **propellers** undamaged?
- Are the **aircraft arms** extended and locked in place, with the **antennas** pointing down?
- Do the **motors** rotate freely without grinding?
- Is the **camera lens** clean?
- Is the **camera payload** locked in place?
- Is the **controller Mission switch** set OFF or ON as required?

## D. Place the Aircraft in the Clear

Place the aircraft in a flat and wide outdoor area. Make sure there are no obstacles, buildings, trees, etc., in the immediate surroundings that could interfere with flight takeoff. The operator should be at least 15 ft away from the aircraft and should be facing the tail of the aircraft.

## E. Unfold the Controller Antennas

Unfold the controller antennas as shown in [Figure 4.E](#).

## F. Power On the Aircraft and Controller

Power on the aircraft and controller as described in section [6.E](#).

## G. Tap the Controller Preflight Check Button

With the Go Flight App on the controller, tap the green square at the top (e.g.,  ) to display the controller's preflight checklist (see [Figure 7.D](#)).

## H. Flight Modes (A, P, and S)

Select one of the following flight modes.

### H1. Attitude Mode (A)

Attitude Mode uses the internal gyros to self-level the aircraft when the control sticks are released. While this is a self-leveling mode, it does not provide position hold since all GPS and other aircraft positioning capabilities are disabled. The aircraft will not actively maintain a stable hover. It will not actively come to a stop when the joysticks are released. Instead, it will maintain its momentum and slowly slide to a stop.

---

 **Attitude mode is for experts – the pilot must fly cautiously and allow increased clearance for maneuvering.**

---

### H2. Position Mode (P)

In Position Mode, all the GPS and other capabilities are enabled to maintain position hold without active stick inputs. Position Mode also limits aircraft speed to 5 m/sec (11 mph), maximizing flight time. GPS and other positioning capabilities are enabled by default. The Forward Obstacle Detection feature is deactivated by default and must be turned on by using the icon on the controller display screen as described in [7.B12](#).

### H3. Sport Mode (S)

Use Sport Mode to fly up to 18 m/sec (40 mph) in windless conditions. The joysticks are more sensitive in Sport Mode. Small movements of the joysticks will create quick movements of the aircraft.

---

 **If compass calibration is compromised during flight, the aircraft will switch to Attitude mode and display a warning. The aircraft will usually recover within a few seconds and automatically return to its prior GPS mode (Sport or Position). However, if it remains in Attitude mode, landing the aircraft and recalibrating the compass is recommended.**

---

### H4. Gust Warning (any Mode)

The aircraft will automatically reduce speed to maintain stability in windy conditions. When this happens, a Gust warning message is displayed on the controller.

## I. Turning the Motors On and Off

Take the aircraft out of locked mode and start the propellers by pulling both controller sticks toward you and inward, as shown in

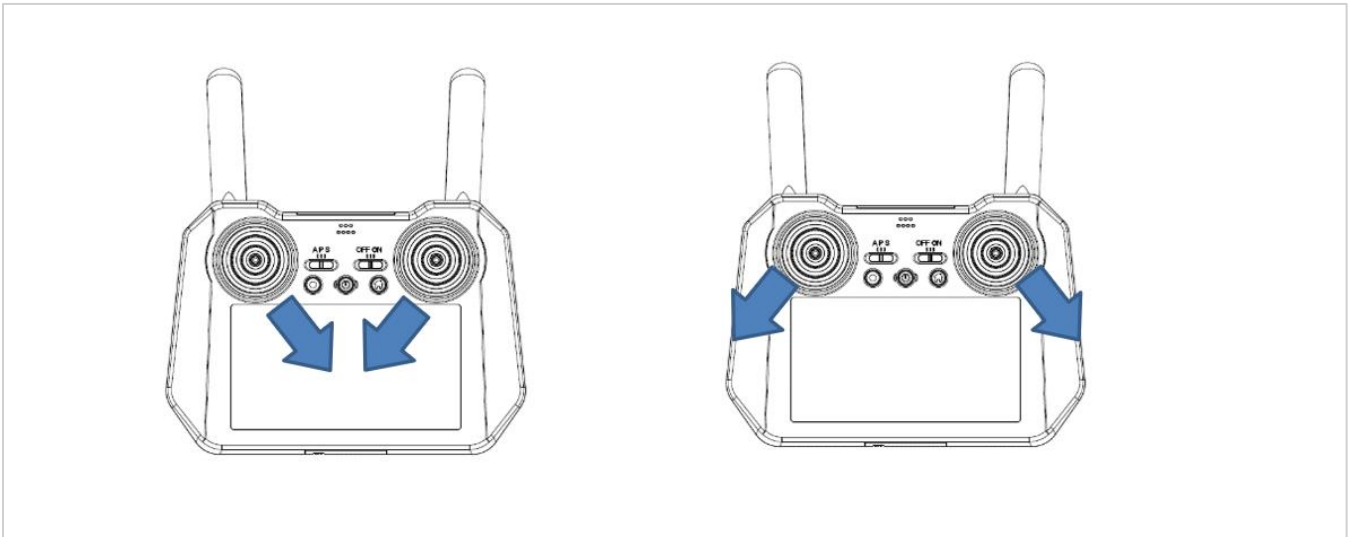

FIGURE 8.E TURNING MOTORS ON (LEFT) AND OFF (RIGHT)

---

▣ **The motors power off automatically when the aircraft lands.**

---



## J. Manual Joystick Operation

The SIRAS controller is set to Mode 2 by default. In a Mode 2 RC transmitter, the left joystick controls yaw and throttle (up/down motion) and the right joystick controls roll and pitch. The roles of the joysticks can be reversed by switching to Mode 1 as described in [7.B6ii, Control Menu](#).

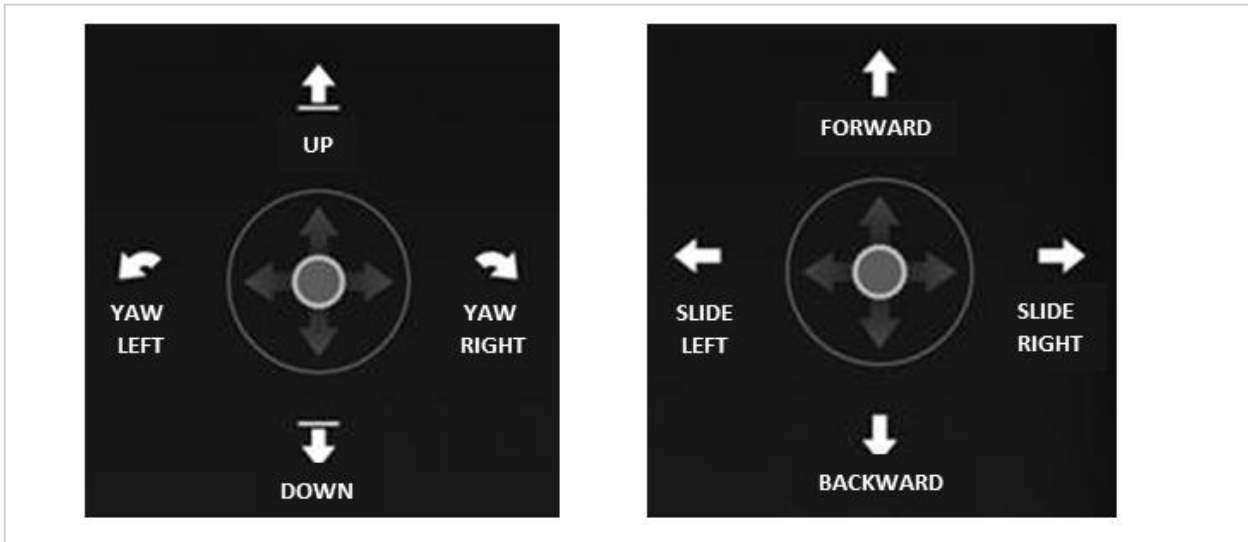

FIGURE 8.F JOYSTICK CONTROLS (LEFT AND RIGHT, IN MODE 2)

### J1. Left Joystick

Pushing the left joystick forward will increase the power to the motors, causing the aircraft to take off and climb vertically. Pulling the left joystick back reduces power to the motors, causing the aircraft to lose altitude and land. Pushing the left joystick to the right will yaw the nose of the aircraft to the right while pushing the joystick to the left will yaw the nose of the aircraft to the left.

Note that the aircraft will stop the yaw function when descending and yawing simultaneously if the maneuver is too rapid. This is to preserve power should a landing sequence be initiated. If yawing during descent, descend at a slow enough rate to prevent this safety feature from being activated.

### J2. Right Joystick

Push the right joystick forward to pitch the aircraft forward. The further you push the joystick forward, the faster the aircraft will accelerate forward. Pull the joystick back to pitch the aircraft backward. Pushing the joystick to the right will roll the aircraft to that side and cause it to slide right without yawing. Moving the joystick to the left will roll the aircraft to that side and cause it to slide left without yawing.

## K. Scroll Wheels: Camera Aiming and Zoom

### K1. Left Scroll Wheel



The left scroll wheel operates the tilt of the payload gimbal. Roll the wheel counterclockwise to aim the camera lower. Roll it clockwise to aim higher. The tilt angle is displayed via the green bar in the shutter group on the controller ([7.B8vi](#)).

### K2. Right Scroll Wheel

The right scroll wheel operates either the left-right pan of the payload gimbal or the camera zoom level, depending on the controller setting selected, as described in the [Action](#) paragraph of [7.B6ii](#). If the Action option is set to Pan, roll the wheel clockwise to aim the camera to the right. Roll it counterclockwise to aim it to the left. If the Action option is set to Zoom, roll clockwise to zoom in and counterclockwise to zoom out.

- 
- ☛ **To view to the left or right while zooming, yaw with the left joystick (rather than panning with the right wheel) while zooming with the right wheel.**
- 

## L. Recording Images and Video

Use the white Shutter button (  ) to capture a single image or to toggle video recording on and off. During video recording, the button changes to a Stop Video button (  ).

Alternatively, use the Capture button on the controller ([Figure 4.A](#), item 11) to take single images or start and stop video recording.

Content is stored on the aircraft SD card. Low-resolution previews of recorded content can be seen on the controller by tapping the Replay icon (  ). Images and video can also be captured by pressing the Capture button on the controller ([Figure 4.A](#), item 11).

## M. Collision Avoidance

The Collision Avoidance (  ) icon on the controller ([Figure 7.C](#), item 9) toggles the Collision Avoidance system. When active, the controller display behaves as described in [7.B12](#).

This radar-based system can detect objects in front of the aircraft as small as 0.1 m<sup>2</sup> (1 ft<sup>2</sup>). Its range is up to 30 m (100 ft), and it has a front-facing field of view of 38°. The system is effective at aircraft speeds of 5 m/s (11 mph) or less. When an object is detected, the aircraft will stop flying forward and hover in position until manually moved up, down, back, or to one side or the other. The aircraft will not advance forward until the object is no longer in its path or the Collision Avoidance feature is turned off.

---

 **The Collision Avoidance system is not effective at aircraft speeds faster than 5 m/s (11 mph).**

 **Collision Avoidance is automatically activated when the Return to Home feature is selected.**

---

## N. Return to Home

When the Return to Home feature is activated (by pressing the “House” button on the controller, [Figure 4.A](#), item 9), the aircraft will fly from its current position to its takeoff point in a straight line. Forward obstacle detection is automatically activated. The aircraft will maintain either its current altitude or the “RTH” altitude preset by the pilot, whichever is greater. When it arrives at the takeoff location, the aircraft will land automatically.

The pilot can override the Return to Home activity at any time by switching the flight mode (A – P – S) from the current mode to a different one and then back again if desired. For example, if the RTH flight is happening too slowly and the flight mode is set to Position mode, select Attitude, allow the aircraft to switch to ATT mode as displayed on the controller screen, then switch to Sport mode and turn off Collision Avoidance. This takes aircraft out of RTH mode and can be quickly returned under the pilot’s control. This sequence might be used if the aircraft is far from the takeoff point and its batteries are running low.

## O. Remove and Charge the Batteries after a Flying Session

After a flying session, power off the aircraft and remove the batteries. Reverse the setup steps described in Chapter 0.

---

 **Charge the batteries promptly after the flight. Batteries will drain (very slowly) even when not in the aircraft.**

---

## P. Creating and Flying a Preplanned Mission

When the controller’s Mission switch is set to ON or the Manual/Waypoint box is toggled to Waypoint, the controller switches to Mission Planning mode. This mode allows you to preplan an entire flight (or “mission”), including camera actions at waypoints. Alternatively, you may load a saved mission. Once a mission is ready, you can direct SIRAS to carry it out.

In Mission Planning mode, the controller swaps the map and image, and new controls appear, as shown in [Figure 8.G](#) (In the Figure, the Add New and Load controls are also shown, as if the Waypoint Tool (item 1) has just been tapped).

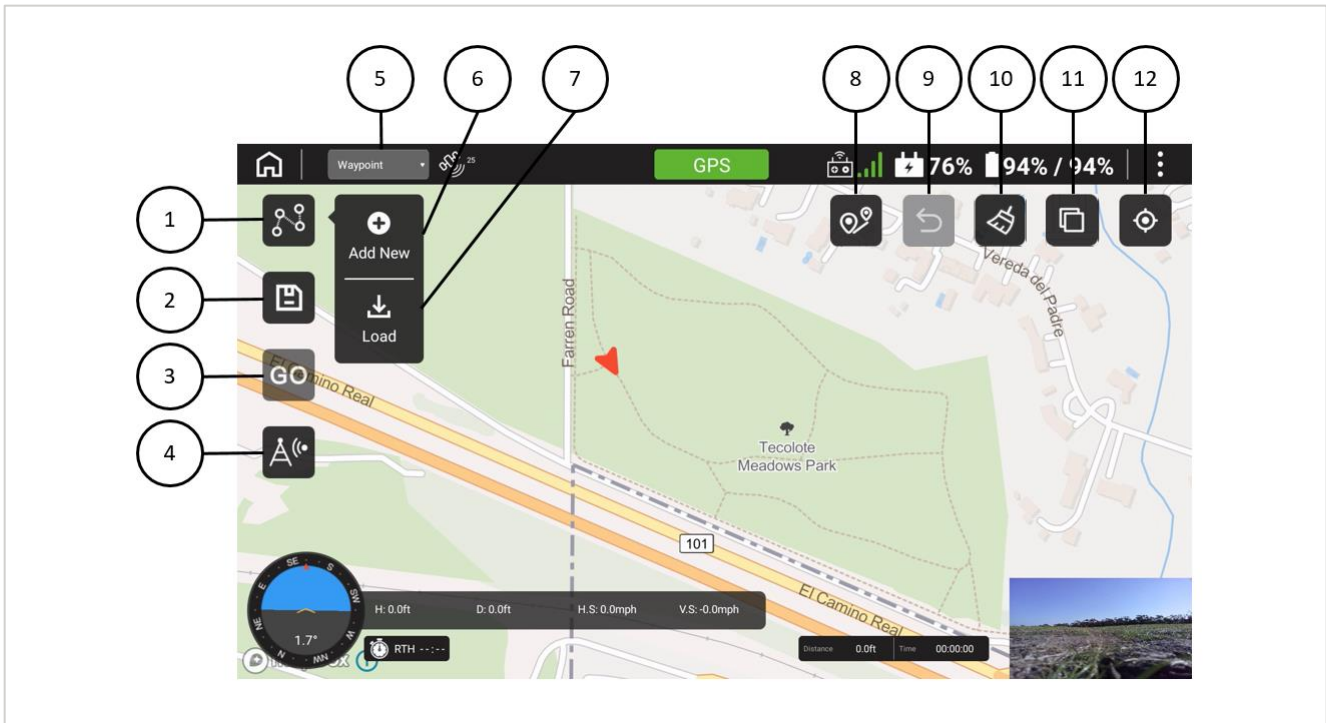



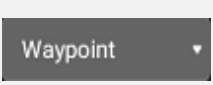
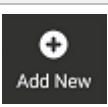
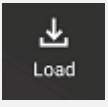







FIGURE 8.G MISSION PLANNING (WAYPOINT) CONTROLS

**TABLE 8.A MISSION PLANNING (WAYPOINT) CONTROLS**

ICON	NAME	DESCRIPTION
1. 	Waypoint Tool	Brings up the Add New and Load buttons
2. 	Save	Saves the current mission to the controller's microSD card (or internal storage if no microSD card is installed)
3. 	GO	Start flying the mission
4. 	Collision Avoidance	Toggle Collision Avoidance
5. 	Flying Mode	Indicates Waypoint or Manual mode. This can be set by tapping this button on the screen or changing the Mission switch on the controller. ( <a href="#">Figure 4.A</a> , item 7)
6. 	Add New (Waypoint)	Tap the Waypoint Tool (item 1) to bring up the submenu containing this button. Tap this button to delete all existing waypoints, and then tap on the map to set one or more waypoints.
7. 	Load	Tap the Waypoint Tool (item 1) to bring up the submenu containing this button. Tap this button to load a saved mission (a list of waypoints).
8. 	Measure Distance	A toggle that displays or clears distance measurements between waypoints
9. 	Undo	Undo the previous action
10. 	Delete	Delete all waypoints
11. 	Switch map	Change to a different map (see <a href="#">Chapter 0</a> for an explanation of how maps get loaded into the controller)
12. 	Center	Tap this to center the map

 **Add New deletes all existing waypoints.**

### P1. Drawing Waypoints

Start planning a mission by entering Waypoint mode by turning the controller's Mission switch ON or tapping the flight mode control to select Waypoint (item 5, above).

At this point, you may tap anywhere on the map to create a new waypoint. You do not need to tap the

Waypoint Tool (). The controller will display the waypoint in blue, along with a line segment

connecting your current location to the first waypoint. Tapping elsewhere creates a second waypoint with a connecting line segment. Waypoints are numbered consecutively. [Figure 8.H](#) shows a map with two waypoints drawn.

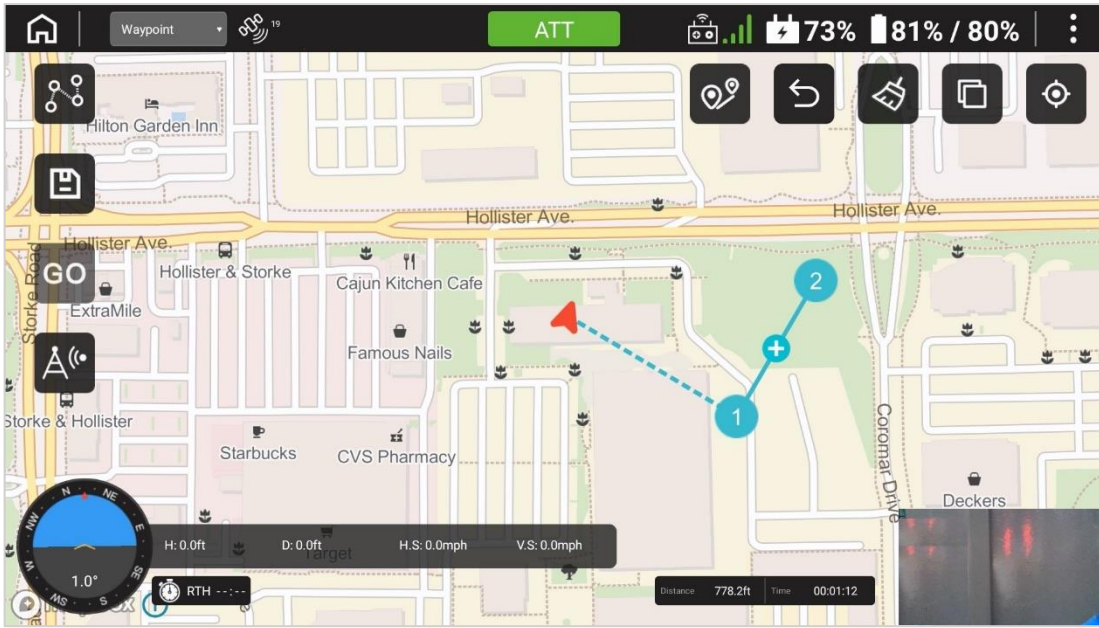

FIGURE 8.H DRAWING THE FIRST TWO WAYPOINTS

You can continue tapping on the map to draw additional waypoints. You can also drag any existing waypoint to a new position.

## P2. Specifying Actions at Waypoints

At each waypoint, you can direct SIRAS to perform any one of several actions. Tap on the waypoint to pull up the Waypoint Settings menu, as shown in [Figure 8.I](#). On this menu, tap the ( **Waypoint >** ) link to pull up the Waypoint Type menu. The waypoint types are described in [Table 8.B](#).

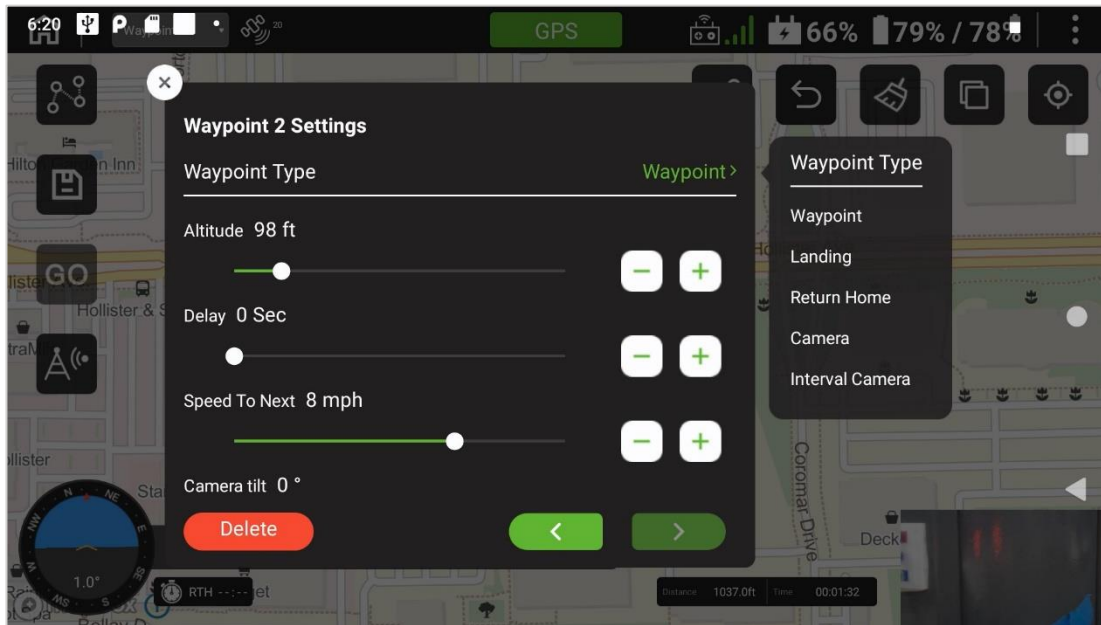

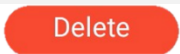



FIGURE 8.1 WAYPOINT SETTINGS AND TYPES

TABLE 8.B WAYPOINT TYPES

WAYPOINT TYPE	DESCRIPTION
<b>Waypoint</b>	No special action
<b>Landing</b>	After arriving at this waypoint, land the aircraft (This is only available for the last waypoint in a mission)
<b>Return Home</b>	After arriving at this waypoint, the aircraft will fly to the starting point and land (This is only available for the last waypoint in a mission)
<b>Camera</b>	Take a picture at this waypoint
<b>Interval Camera</b>	Take a series of pictures, beginning at this waypoint

The Waypoint Settings menu includes the following controls. The menu is large and extends beyond the display screen. Use the touchscreen to drag the menu upward and view the lower half.

**TABLE 8.C WAYPOINT SETTINGS**

CONTROL	DESCRIPTION
	Delete this waypoint
	Close the Waypoint Settings window
	Edit the previous waypoint
	Edit the next waypoint
<b>Altitude</b>	A slider bar and buttons to specify the altitude (height above the ground) at this waypoint. The aircraft will ascend or descend to this height before leaving the previous waypoint. Range: 50 ft (16 m) to 400 ft (120 m)
<b>Delay</b>	Length of time to wait at this waypoint before continuing. Range: 0 to 30 seconds
<b>Speed to Next</b>	The speed at which the aircraft will fly to the next waypoint. Range: 2 to 44 mph (1 to 20 m/s). However, with Collision Avoidance on, as recommended, the maximum speed is 11 mph (5 m/s)
<b>Camera Tilt</b>	Angle at which the camera is aimed downward. 0° represents horizontal. Range: -90° (straight down) to 15° (slightly up)
<b>Drone Heading</b>	Amount of yaw after departing from this waypoint. 0° orients the aircraft straight ahead into the direction of travel. 90° yaws to the right, and so on. Range: 0° to 360°
<b>Interval Shooting</b>	(Only at an Interval Camera waypoint): Interval between snapshots. Range 0 to 255 seconds
<b>Latitude / Longitude</b>	The latitude and longitude of the waypoint. You can tap on these values and edit them directly

Waypoint settings do not include the choice of Thermal or Visual camera; the pilot must apply all camera settings before starting the mission.

- 
- ① A preplanned mission can only capture still pictures. It cannot capture videos.**
  - ① A preplanned mission cannot change camera settings, including the Zoom setting.**
-



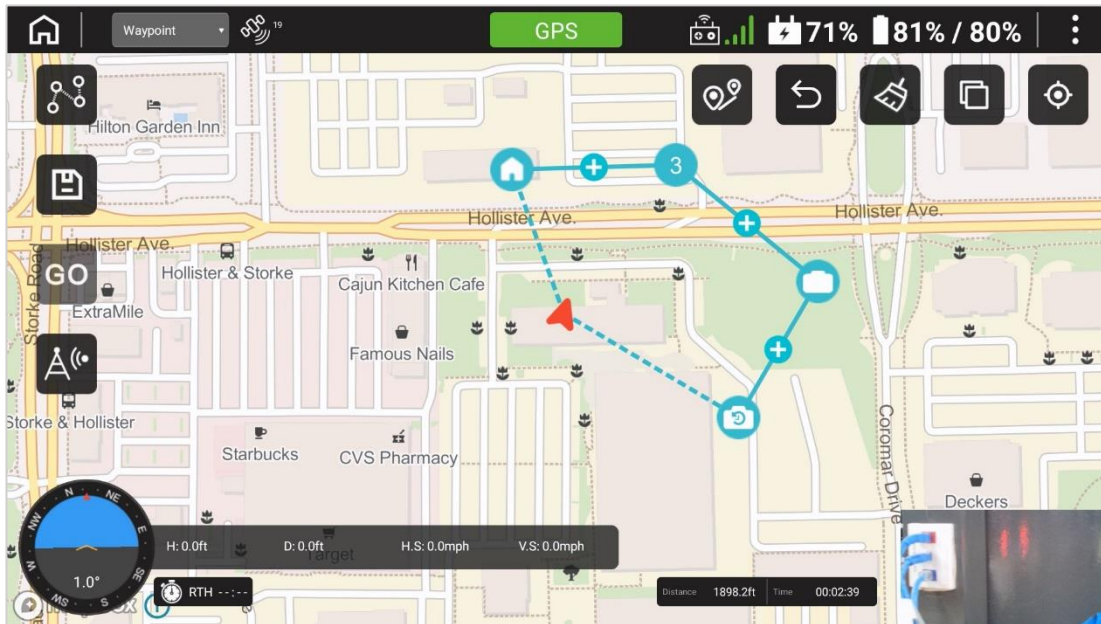







FIGURE 8.J WAYPOINT SYMBOLS ON A MAP

[Figure 8.J](#) shows a completed plan with all waypoint types. Waypoint icons are described in Table 8.D.

TABLE 8.D WAYPOINT ICONS

SYMBOL	MEANING
	Ordinary waypoint; no action (Number indicates ordering)
	Camera waypoint
	Interval camera waypoint
	Point between waypoints; Tap this to insert a new waypoint
	Return To Home waypoint
	Aircraft location and orientation

- (i) You can insert a waypoint by tapping on the + between two waypoints**
- (i) A waypoint can only have one type. You cannot take a picture at a Return to Home waypoint, but you can add a Return to Home waypoint just beyond the last camera waypoint.**

### P3. Saving a Mission

---

- ⚠ **Ensure that your microSD card is inserted before you save your mission.**
  - ℹ **Before you run a mission, you MUST save it and give it a name.**
- 

To save a mission, tap the Save button (  ), and type in the filename on the keyboard. The keyboard resembles a smartphone keyboard, with shift and numeric controls at the lower left.

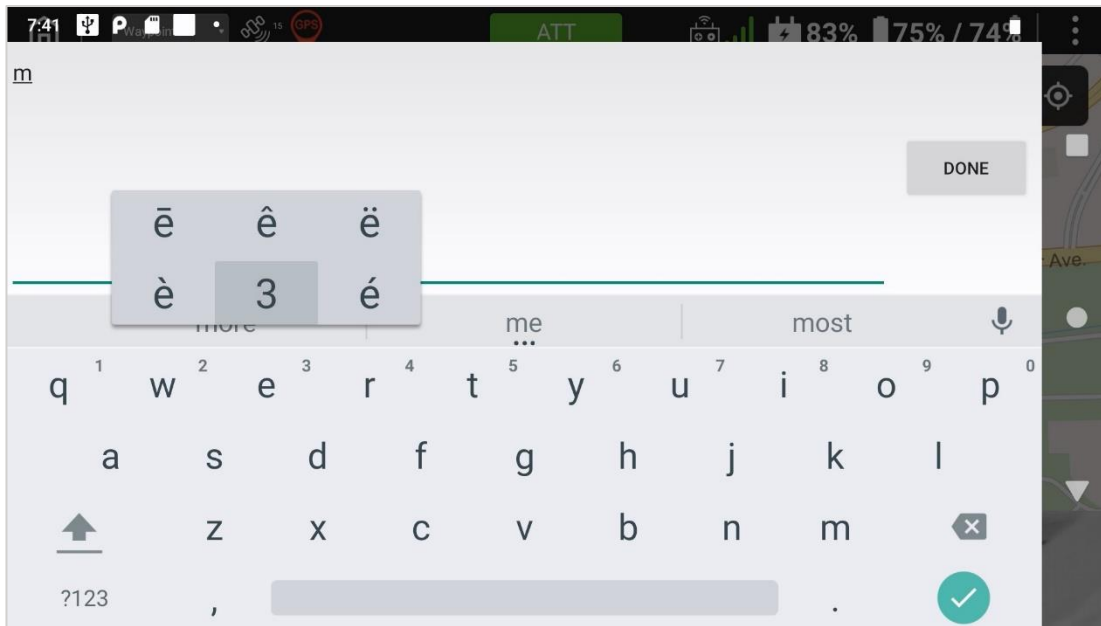



FIGURE 8.K USING THE KEYBOARD TO NAME THE MISSION

### P4. Loading a Saved Mission

You can load an existing flight plan by tapping the Waypoint Tool (  ) and the Load button (  ) on the submenu. This brings up a dialog box that allows you to select a saved mission.

### P5. Flying a Mission

---

- ⚠ **Do not fly a mission if you do not have a line of sight to all its waypoints (In particular, do not fly a saved mission unless you are close to the first waypoint).**
- ⚠ **To fly a mission, perform all preflight activities as described in sections [8.A](#) through [8.C](#).**
- ℹ **A mission must take off from the ground. You may not hover and then start a mission.**
- ℹ **You cannot start a mission unless Collision Avoidance is set to On. You may need to set it manually.**

- ▣ **Select the Thermal or Visual camera and related camera settings before starting the mission.**
- 

Set the controller Mission switch to ON or tap the Flight Mode box in the Go Fly App to set it to Waypoint.

Tap the Go (  ) button. The aircraft will lift off and begin flying to its first waypoint.

---

- ⚠ **Observe the flight carefully. Be prepared to take manual control (by switching Mission to OFF) if the aircraft is flying dangerously.**
-

## 9. UPDATING THE CONTROLLER AND AIRCRAFT FIRMWARE

This chapter describes how to update the controller application software and the aircraft-embedded software, collectively referred to as “firmware.” The two are always upgraded together.

Updates to the firmware are performed by loading the update onto a microSD card and installing the new software onto the controller. Once that is completed, the controller software will update the aircraft firmware wirelessly.

---

**ⓘ To improve data security, the SIRAS controller does not support WIFI data transfer.**

**⚠ The controller and aircraft must have matching firmware versions.**

---

The steps to update the controller application and the aircraft firmware are as follows:

1. Power off the aircraft and the controller.
2. Download the update files from the Teledyne FLIR support site at [www.flir.com/siras](http://www.flir.com/siras) to a PC that has a microSD card reader.
3. If necessary, unzip the downloaded file(s).
4. Remove the microSD card from the controller (see [Figure 4.D](#)).
5. Insert the microSD card into a PC’s card reader slot.
6. Copy the downloaded, unzipped files to the top directory of the microSD card.

---

**ⓘ Update files have version numbers in their names and will not conflict with older versions on the microSD card. Other files may have invariant names and are intended to be overwritten.**

**ⓘ The \*.apk file represents a software update.**

**⚠ Do not rename the files.**

---

7. Use the PC’s file manager to eject the microSD card from your PC. This does not normally physically eject the microSD card.
8. Remove the microSD card from the PC and insert it into the controller.
9. Power on the aircraft.
10. Power on the controller.

11. Open the File Manager on the controller by following these steps:
  - a. To expose the Android icons from the SIRAS application opening screen, swipe left from the screen's right-hand edge, as shown in [Figure 9.A](#).

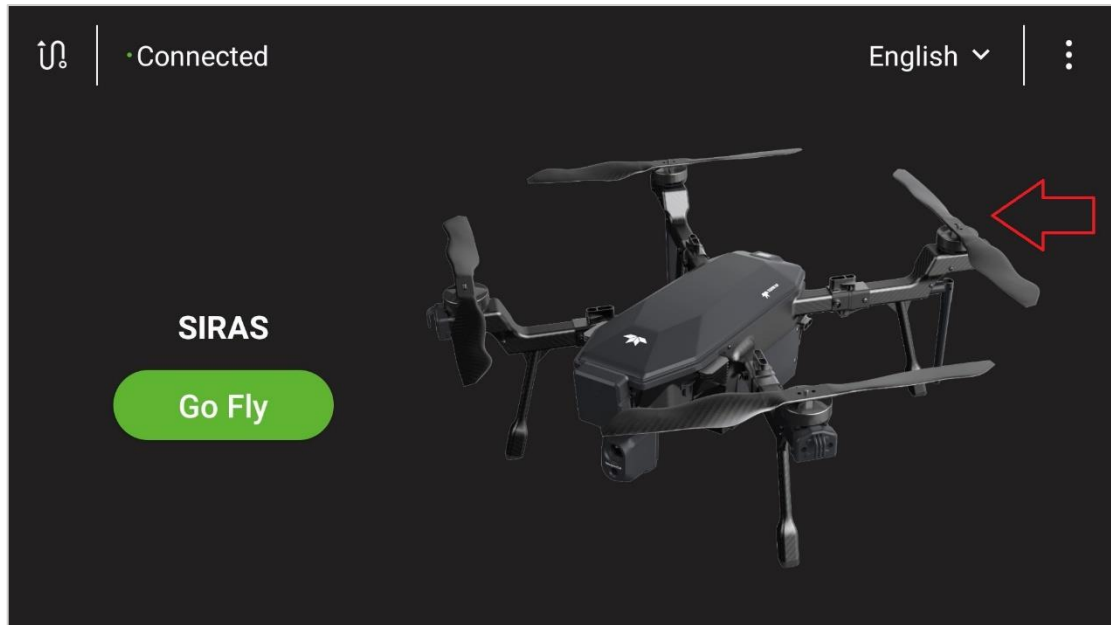

FIGURE 9.A SWIPE LEFT TO EXPOSE THE ANDROID ICONS

- b. Tap the circle icon on the right side of the screen before it disappears:

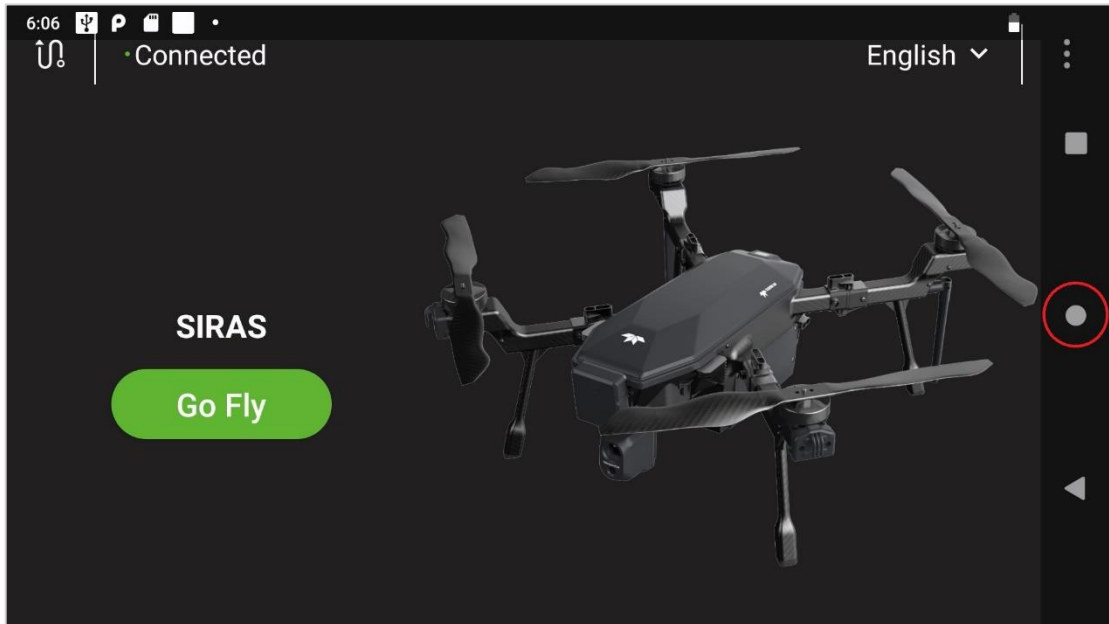

FIGURE 9.B TAP THE CIRCLE ICON

- c. Select the File Manager icon (If it does not automatically appear, swipe from below and tap it).

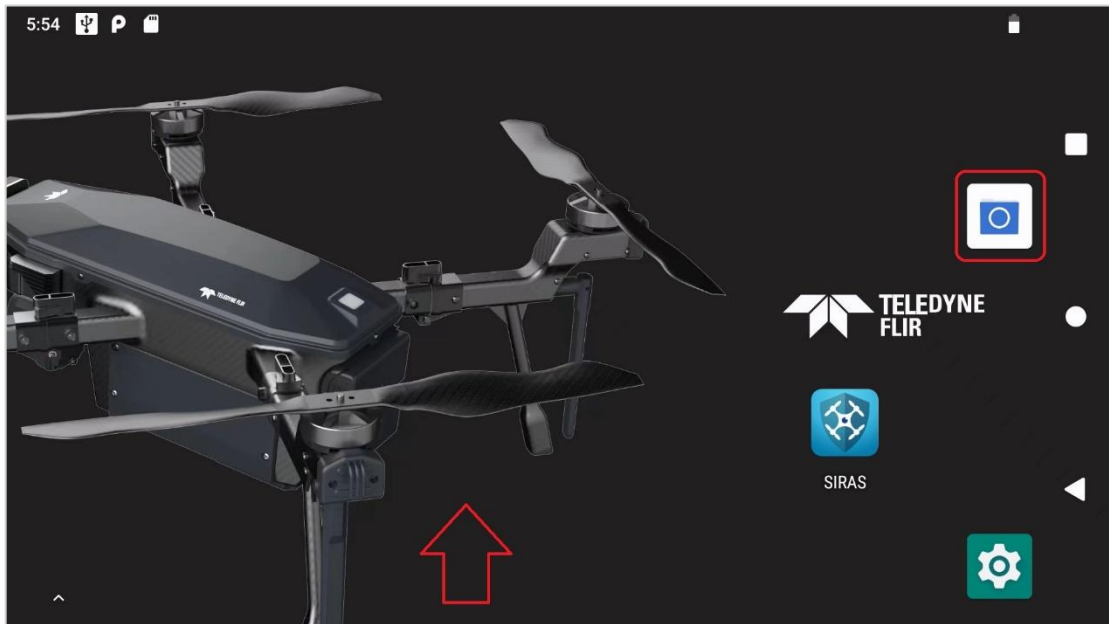

FIGURE 9.C FILE MANAGER ICON

12. In the File Manager, tap the “3 lines” icon on the left side of the screen and select “SanDisk SD card” (or the name of your microSD card), as shown in [Figure 9.D](#).

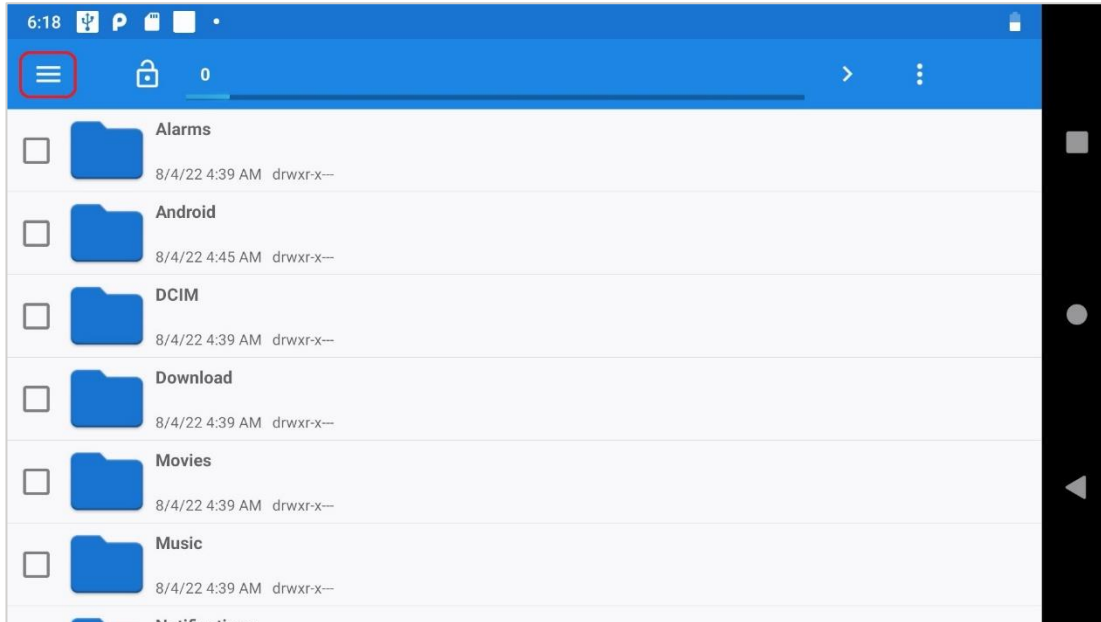

FIGURE 9.D FILE MANAGER—MICROSD CARD

13. Look for the **\*.apk** file you copied to the microSD card. Tap it to start installing the new controller application. The installer will “stage” the application for a few seconds and then prompt you to install it. Tap “INSTALL” to proceed. After installation, tap “OPEN” to run the application.

- 
- i** **Installation of the controller software takes about 20 seconds.**
  - i** **If you tap DONE instead of OPEN, the next time you run the Go Fly app, you will be prompted to continue installing the aircraft firmware (assuming it is out-of-date with the controller software).**
-

14. Place the controller near the aircraft, antennas extended.
15. The controller will wirelessly connect to the aircraft and check its firmware version. If the aircraft does not have firmware compatible with the controller's software, the controller will post a "New Firmware" dialog box. Tap the Update button.

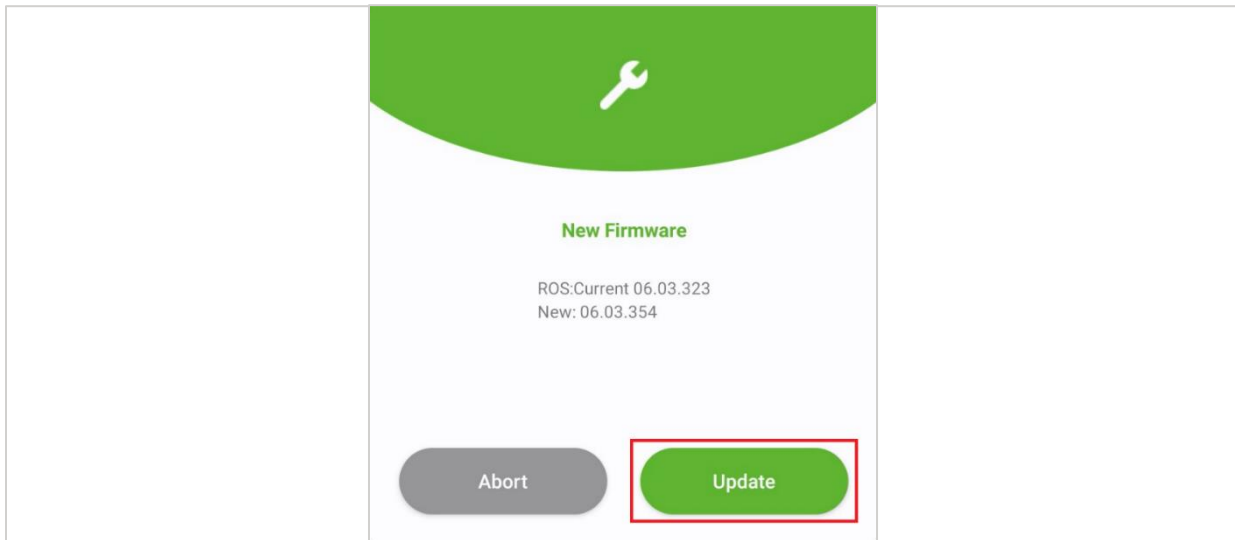

FIGURE 9.E SOFTWARE UPDATE: NEW FIRMWARE

---

**ⓘ You can update the aircraft firmware later by tapping the home screen (  ) icon at the top right (Figure 7.C, item 6), selecting the "About" menu, and tapping the "Update" button. The Update button only appears if the aircraft firmware is out of date.**

---

16. The controller will wirelessly update the aircraft firmware, which can take up to 10 minutes. The speed depends on the update size and the radio connection quality. During this time, an icon indicates the update's progress. When done, the controller will display an Update Success popup. Click OK.

---

**⚠ If the update fails, wait a few seconds, check the proximity of the controller to the aircraft, and tap Retry in the failure message.**

---

17. Power off the drone and power it back on.



## 10. LOADING MAPS INTO THE CONTROLLER

Follow the steps in See Chapter 9, [Updating the Controller and Aircraft Firmware](#) to insert the controller's microSD card into your PC's microSD card reader.

Visit [www.flir.com/siras](http://www.flir.com/siras) to download maps that the SIRAS controller can use. Map files are in the MBTiles format. An example map file is ***USA-west.mbtiles***, a 3.3GB file that contains mapping data for the western United States.

Download one or more maps onto the controller SD card into the directory **<drive>:\FlyWatch\map**.

Eject the microSD card from your PC and reinsert it into the controller.

## 11. AIRCRAFT MEMORY CARD

The aircraft contains a memory card containing high-resolution images and videos. You must physically remove this card and read its contents to retrieve these files.

- 
- ① **The controller, unlike the aircraft, stores only low-resolution images because it is limited by communication bandwidth.**
  - ① **Use tweezers to remove the microSD card from the aircraft.**
  - ① **Use only FAT32 format for the microSD card. ExFAT format does not currently provide reliable performance.**
- 

Take the following steps to retrieve files from the aircraft's microSD card:

1. Power off the aircraft.
2. Uncover the microSD card slot. The cover is a rubber, T-shaped piece attached at the bottom. Pry the top part off and slide it away to expose the micro SD card slot, as shown in [Figure 11.A](#).

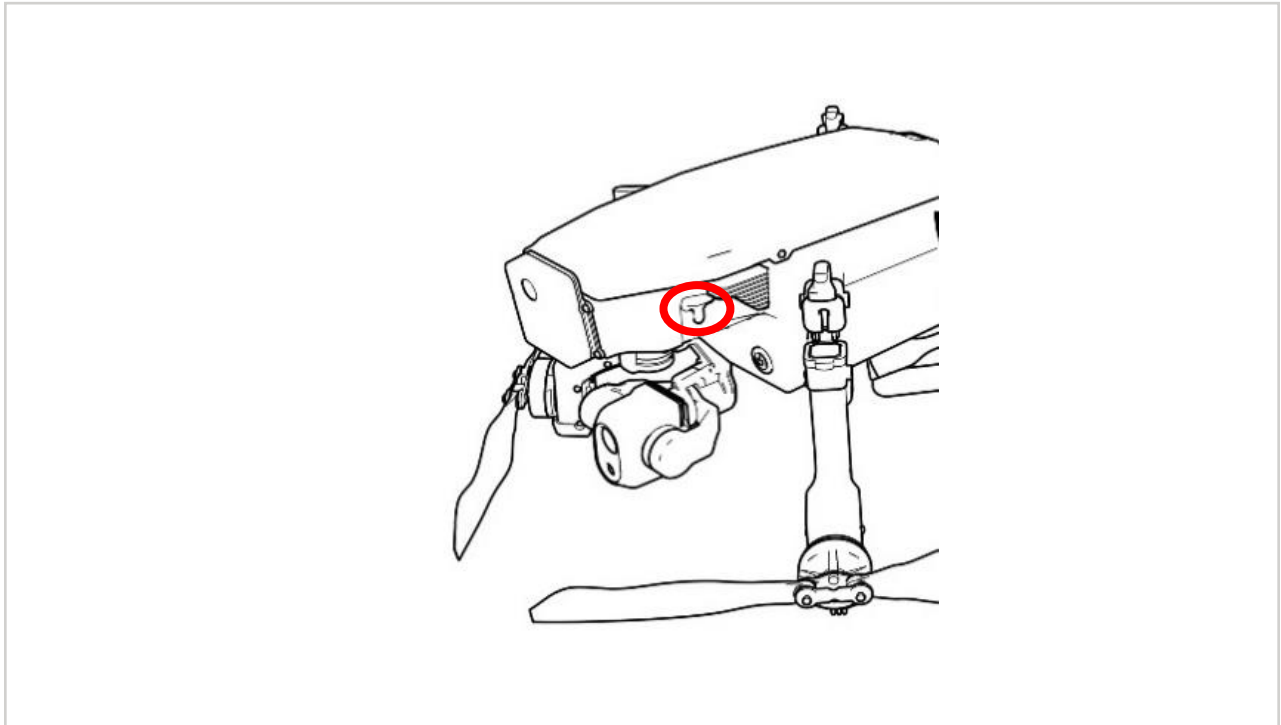

FIGURE 11.A MICROSD CARD SLOT ON AIRCRAFT

3. The microSD card slot has a small black catch on the left side. While holding it farther left, carefully use a pair of tweezers to retrieve the microSD card.
4. Insert the microSD card into a card reader on your computer.
5. The images and videos will be stored in the DCIM directory, within subdirectories named for the date, in the YYYYMMDD form. For example: <drive>\DCIM\20221205.
6. Return the microSD card (or another microSD card) to the slot on the aircraft with the contacts up.

---

 **Always fly with a microSD card inserted in the aircraft.**

 **Insert the microSD card fully into its slot, ensuring that the catch is engaged. Cover the slot.**

---

## 12. PRODUCT REGISTRATION

For product support, please register the SIRAS airframe and payload at [www.flir.com/register](http://www.flir.com/register).

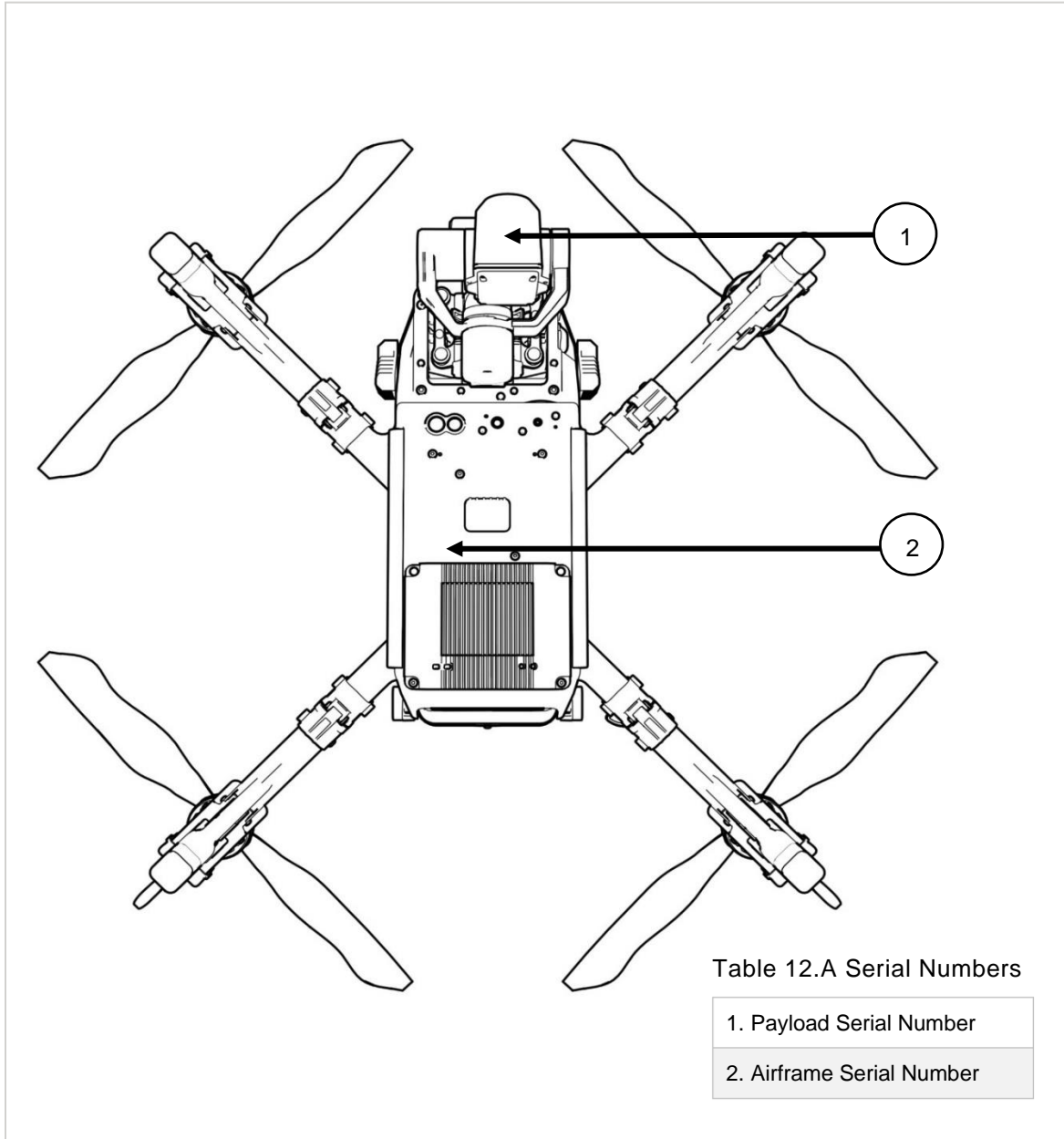

FIGURE 12.A PAYLOAD AND AIRFRAME SERIAL NUMBER LOCATIONS

## 13. WARRANTY AND NOTICES

### A. Limited Warranty, Exclusions, and Disclaimers

**1. Limited Warranty.** Unless superseded by individual Product warranty terms set forth in the Specifications, a warranty section of Seller's website at [FLIR.com](https://www.flir.com), or in this Agreement, SELLER WARRANTS THAT FROM THE DATE OF DELIVERY AND FOR A PERIOD OF ONE YEAR, THE PRODUCTS WILL CONFORM IN ALL MATERIAL RESPECTS TO ITS SPECIFICATIONS AT THE TIME OF SALE AND BE FREE FROM MATERIAL DEFECTS UNDER PROPER USE AND SERVICE IN ACCORDANCE WITH THE SPECIFICATIONS. "Specifications" means the specifications delivered to the Buyer with or in the Product and/or published on Seller's website for the applicable version of the Product. Buyer agrees that Specifications and other warranty information may be supplied only in the English language unless otherwise required by local law without the possibility of contractual waiver or limitation. This limited warranty extends only to Buyer and is not transferable to any other party and any transfer made in violation of this provision shall be void. The warranty applies only to the unmodified portion of the Products. Buyer is responsible for the results obtained from the use of the Products. Buyer's sole remedy, and Seller's sole liability, for any breach of the foregoing warranty shall be, at Seller's sole discretion, to replace or repair any part or parts (or redeliver services) which were delivered in breach of the foregoing warranty.

**2. Warranty Exclusions and Disclaimers.** SELLER MAKES NO OTHER EXPRESS OR IMPLIED WARRANTIES, INCLUDING BUT NOT LIMITED TO IMPLIED WARRANTIES OF MERCHANTABILITY, FITNESS FOR A PARTICULAR PURPOSE (EVEN IF BUYER HAS NOTIFIED SELLER OF ITS INTENDED USE FOR THE PRODUCTS) OR NON-INFRINGEMENT. SELLER FURTHER EXPRESSLY DISCLAIMS ANY WARRANTY OF THE PRODUCTS WHERE THE ALLEGED NONCONFORMITY IS DUE TO NORMAL WEAR AND TEAR, ALTERATION, MODIFICATION, REPAIR, ATTEMPTED REPAIR, IMPROPER USE OR STORAGE, IMPROPER MAINTENANCE, NEGLIGENCE, ABUSE, FAILURE TO FOLLOW ANY PRODUCT INSTRUCTIONS, DAMAGE (WHETHER CAUSED BY ACCIDENT OR OTHERWISE), VARIABLES OUTSIDE THE CONTROL OF SELLER, OR ANY OTHER IMPROPER CARE OR HANDLING OF THE PRODUCTS CAUSED BY ANYONE OTHER THAN SELLER. SOME JURISDICTIONS DO NOT ALLOW THE EXCLUSION OF EXPRESS OR IMPLIED WARRANTIES, SO THE ABOVE EXCLUSION MAY NOT APPLY TO BUYER. IN THAT EVENT, SUCH WARRANTIES ARE LIMITED IN DURATION TO THE WARRANTY PERIOD. BUYER MAY ALSO HAVE OTHER RIGHTS THAT VARY FROM JURISDICTION TO JURISDICTION. "Variables" include operator skills, non-Seller equipment used with the Products, and environmental and climatic conditions.

### B. Ingress Protection Rating and Maintenance

An IP54 ("Ingress Protection") rating means that your product will be protected against contamination from limited amounts of dust and other particles. Additionally, you can be confident that it will be protected from water sprays from all directions.

The IP54 performance of the SIRAS aircraft can be compromised over time. Long-term usage may result in wear and degradation in protection. To maintain the IP54 performance of the design, please follow these instructions:

- Do not fold the arms of the aircraft in the rain. First bring the aircraft to an indoor area or rain shelter, wipe off the rainwater on the aircraft, then fold and store it. This is to prevent water from infiltrating the internal parts, which can impact the IP protection capability of the aircraft.

- Before flying, first make sure that the battery port, battery case surface, battery case port, and battery case surface are dry, then insert the batteries into the battery slot.
- When charging, make sure that the battery port and surface of the batteries are dry before charging to prevent any liquid infiltration which may lead to damage that is not covered by the warranty.

Under the following situations, the aircraft will not have IP54 protection:

- The protective covers of the various ports are not installed correctly.
- The waterproof rubber parts of the aircraft are loosened or other damage to the aircraft has occurred, such as case cracks, failing waterproof glue, etc.

Do not modify the aircraft. Doing so may reduce imaging performance, flight performance, and IP rating, all of which can impact safety of flight.

Only use authorized spare parts made by the original equipment manufacturer and installed by approved service providers. Failure to do so may void the warranty.

## **C. Legal Obligations**

Before using this product, read this User Manual carefully to understand your rights, responsibilities, and how to safely operate the product. If you do not, it may lead to bodily injury, property damage, or endangerment to your safety and the safety of others. By using this product, you confirm and agree that:

- You have read the User Manual and will comply with all of its guidance, restrictions, precautions, and instructions.
- You will comply with all country specific laws and regulations pertaining to operating unmanned aerial platforms, including all flight safety regulations, including being Part 107 certified.
- You will adhere to any restricted airspace provisions that govern piloting unmanned aerial platforms and take active measures to safely operate the product.
- You will be responsible for your actions and all possible consequences incurred by piloting the aircraft.
- You will comply with all local, state, and federal regulations regarding privacy, and to use this product only for normal purposes; and
- You agree to the terms specified herein, as well as any related policies or guidelines that are released by the Company.

When using the Product, you further agree to the following:

- You will not fly near the flight paths of airplanes and ensure that the aircraft will not cause any impact to any aircraft on the flight path. Please always remain cautious and avoid any other aircraft, and land immediately when necessary.

- You will not fly in any area restricted by any local, regional, or country laws and regulations. Areas where flight restrictions and prohibitions may include, but are not limited to: airports, borders, cities, densely populated areas, sites of large events, emergency incidents (e.g., forest fire), and areas with sensitive facilities (e.g., nuclear power stations, power stations, military facilities, prisons, traffic arteries, hydropower stations, government buildings, etc.);
- You will not exceed the any imposed height restrictions.
- You will make sure the aircraft is flying within the user's line of sight.
- You will not equip the aircraft with any illegal, dangerous, or restricted objects, or otherwise attach payloads that are not expressly permitted by the Manufacturer; and
- When performing aerial photography with the aircraft, you will respect other people's privacy and comply with all local, state and federal privacy regulations. You will not conduct any unauthorized surveillance activities with this product, which include the monitoring, video recording, or photography of activities, performances, exhibitions, buildings, etc.

Notwithstanding any other provision herein, under no circumstances shall Manufacturer / Marketer / Distributor be liable to you or any third party for any consequential, special, incidental, indirect, multiple, administrative, or punitive damages, or any damage of an indirect or consequential nature arising out of or related to Seller's performance under Buyer's Order, including, without limitation, loss of use, loss of revenues, loss of anticipated profits, and cost of capital, whether based upon breach of warranty, negligence, or any other type of claim, and whether grounded in tort, contract, civil law, or other theories of liability, including strict liability, even if advised in advance of the possibility of such damages. The Manufacturer / Marketer / Distributor are entitled to the right to the final interpretation of the aforementioned provisions with the premise of compliance with the laws and regulations. The Manufacturer / Marketer / Distributor are entitled to the right to modify, change or terminate the provisions without prior notification.

© FLIR Commercial Systems, 2022. All rights reserved worldwide. No parts of this manual, in whole or in part, may be copied, photocopied, translated, or transmitted to any electronic medium or machine-readable form without the prior written permission of FLIR Commercial Systems

Names and marks appearing on the products herein are either registered trademarks or trademarks of FLIR Commercial Systems and/or its subsidiaries. All other trademarks, trade names, or company names referenced herein are used for identification only and are the property of their respective owners.

This product is protected by patents, design patents, patents pending, or design patents pending.

If you have questions that are not covered in this manual contact FLIR Commercial Systems Customer Support ([SBA-Cores@flir.com](mailto:SBA-Cores@flir.com)) for additional information. Contact Customer Support for questions related to the use of open-source software in this product. And contact Customer Support prior to returning a camera which is in need of service.

This documentation and the requirements specified herein are subject to change without notice.



This equipment must be disposed of as electronic waste.

Contact your nearest FLIR Commercial Systems, Inc. representative for instructions on how to return the product to FLIR for proper disposal.

**FCC Notice.** This device is a subassembly designed for incorporation into other products in order to provide an infrared camera function. It is not an end-product fit for consumer use. When incorporated into a host device, the end-product will generate, use, and radiate radio frequency energy that may cause radio interference. As such, the end-product incorporating this subassembly must be tested and approved under the rules of the Federal Communications Commission (FCC) before the end-product may be offered for sale or lease, advertised, imported, sold, or leased in the United States. The FCC regulations are designed to provide reasonable protection against interference to radio communications. See 47 C.F.R. §§ 2.803 and 15.1 et seq.

**Industry Canada Notice.** This device is a subassembly designed for incorporation into other products in order to provide an infrared camera function. It is not an end-product fit for consumer use. When incorporated into a host device, the end-product will generate, use, and radiate radio frequency energy that may cause radio interference. As such, the end-product incorporating this subassembly must be tested for compliance with the Interference-Causing Equipment Standard, Digital Apparatus, ICES-003, of Industry Canada before the product incorporating this device may be: manufactured or offered for sale or lease, imported, distributed, sold, or leased in Canada.

**Avis d'Industrie Canada.** Cet appareil est un sous-ensemble conçu pour être intégré à un autre produit afin de fournir une fonction de caméra infrarouge. Ce n'est pas un produit final destiné aux consommateurs. Une fois intégré à un dispositif hôte, le produit final va générer, utiliser et émettre de l'énergie radiofréquence qui pourrait provoquer de l'interférence radio. En tant que tel, le produit final intégrant ce sous-ensemble doit être testé pour en vérifier la conformité avec la Norme sur le matériel brouilleur pour les appareils numériques (NMB-003) d'Industrie Canada avant que le produit intégrant ce dispositif puisse être fabriqué, mis en vente ou en location, importé, distribué, vendu ou loué au Canada.

**EU Notice.** This device is a subassembly or component intended only for product evaluation, development or incorporation into other products in order to provide an infrared camera function. It is not a finished end-product fit for general consumer use. Persons handling this device must have appropriate electronics training and observe good engineering practice standards. As such, this product does not fall within the scope of the European Union (EU) directives regarding electromagnetic compatibility (EMC). Any end-product intended for general consumer use that incorporates this device must be tested in accordance and comply with all applicable EU EMC and other relevant directives.