



RIGOL

Test & Measurement

Product Catalog

Sept. 2023



Contents

Digital Oscilloscope.....	1
DHO900 Series Digital Oscilloscope.....	3
Models and Specifications.....	4
Order Information.....	5
DHO800 Series Digital Oscilloscope.....	6
Models and Specifications.....	7
Order Information.....	8
DHO4000 Series Digital Oscilloscope.....	9
Models and Specifications.....	10
Order Information.....	11
DHO1000 Series Digital Oscilloscope.....	12
Models and Specifications.....	13
Order Information.....	14
DS70000 Series Digital Oscilloscope.....	15
Models and Specifications.....	16
Order Information.....	18
MSO8000/A Series Digital Oscilloscope.....	20
Models and Specifications.....	22
Order Information.....	23
DS8000-R Series Digital Oscilloscope.....	26
Models and Specifications.....	27
Order Information.....	29
MSO/DS7000 Series Digital Oscilloscope.....	31
Models and Specifications.....	32
Order Information.....	34
MSO5000 Series Digital Oscilloscope.....	36
Models and Specifications.....	37
Order Information.....	39
MSO/DS2000A Series Digital Oscilloscope.....	41
Models and Specifications.....	42
Order Information.....	43
MSO/DS1000Z/Z-E Series Digital Oscilloscope.....	45
Models and Specifications.....	46

Order Information.....	47
Bus Analysis Guide.....	49
Power Test and Analysis.....	51
Probes and Accessories Selection Guide.....	53
Function/Arbitrary Waveform Generator.....	57
DG70000 Series Arbitrary Waveform Generator.....	59
Models and Specifications.....	60
Order Information.....	61
DG5000 Series Function/Arbitrary Waveform Generator.....	62
Models and Specifications.....	63
Order Information.....	64
DG4000 Series Function/Arbitrary Waveform Generator.....	65
Models and Specifications.....	66
Order Information.....	67
DG2000 Series Function/Arbitrary Waveform Generator.....	68
Models and Specifications.....	69
Order Information.....	70
DG1000Z Series Function/Arbitrary Waveform Generator.....	71
Models and Specifications.....	72
Order Information.....	73
DG1000 Series Function/Arbitrary Waveform Generator.....	75
Models and Specifications.....	76
Order Information.....	76
DG900 Series Function/Arbitrary Waveform Generator.....	77
Models and Specifications.....	78
Order Information.....	79
DG800 Series Function/Arbitrary Waveform Generator.....	80
Models and Specifications.....	81
Order Information.....	82
Spectrum Analyzers.....	84
RSA5000 Series Spectrum Analyzer.....	86
Models and Specifications.....	89
Order Information.....	90
RSA3000 Series Spectrum Analyzer.....	92
Models and Specifications.....	94
Order Information.....	95

RSA3000E Series Spectrum Analyzer.....	97
Models and Specifications.....	99
Order Information.....	99
DSA800/E Series Spectrum Analyzer.....	101
Models and Specifications.....	102
Order Information.....	103
DSA700 Series Spectrum Analyzer.....	105
Models and Specifications.....	106
Order Information.....	107
EMI Test System.....	108
NFP-3 Near-field Probe.....	110
Common RF Accessories.....	112
RF Accessories Selection Guide.....	113
RF Signal Generator.....	116
DSG5000 Series Microwave Signal Generator.....	118
Models and Specifications.....	119
Order Information.....	121
DSG3000B Series RF Signal Generator.....	123
Models and Specifications.....	125
Order Information.....	126
DSG800/A Series RF Signal Generator.....	128
Models and Specifications.....	130
Order Information.....	131
Digital Multimeters.....	132
DM3000 Series Digital Multimeters.....	132
Models and Specifications.....	133
Order Information.....	134
Data Acquisition/Switch System.....	135
M300 Series Data Acquisition/Switch System.....	135
Models and Specifications.....	136
Order Information.....	136
Programmable Linear DC Power Supplies.....	138
DP2000 Series Programmable Linear DC Power Supply.....	140
Models and Specifications.....	141
Order Information.....	142
DP900 Series Programmable Linear DC Power Supply.....	143

Models and Specifications.....	144
Order Information.....	145
DP800 Series Programmable Linear DC Power Supply.....	146
Models and Specifications.....	147
Order Information.....	149
DP700 Series Programmable Linear DC Power Supply.....	151
Models and Specifications.....	152
Order Information.....	153
Programmable DC Electronic Load.....	154
DL3000 Series Programmable DC Electronic Load.....	154
Models and Specifications.....	155
Order Information.....	156

Digital Oscilloscope



Digital oscilloscope, an essential instrument for the design, manufacturing, and maintenance of electronic equipment, is used by electronic engineers to observe various kinds of analog and digital signals to locate and resolve the problem in their designing and debugging work. DS70000 is the first domestic digital oscilloscope that has a bandwidth up to 5 GHz. It adopts RIGOL's technical platform, greatly improving the consistency and reliability of the digital oscilloscope. The full memory hardware measurement technology ensures high measurement accuracy.

The histogram analysis and waveform search functions offer users a more efficient way to accurately locate and analyze the waveforms. The innovative "UltraVision" and "UltraVision II" technical platform enables RIGOL to deliver products with high waveform capture rate, deep memory depth, full memory hardware measurement, multi-level intensity grading display, and hardware waveform recording and playback. Now RIGOL has developed a series of digital oscilloscopes (including DS1000E, MSO/DS1000Z, DS1000Z-E, MSO/DS2000A, MSO5000, MSO/DS7000, MSO8000/A, DS8000-R, DS70000, DHO1000/DHO4000, and DHO900/DHO800) to meet different customer needs and to improve the testing efficiency.

Model	No. of Analog Channels	No. of Digital Channels	Max. Sample Rate	Max. Memory Depth	Signal Generator	Serial Bus Analysis
DHO900	4	16	1.25 GSa/s	50 Mpts	√ ^[3]	√
DHO800	4	-	1.25 GSa/s	25 Mpts	-	√
DHO4000	4	-	4 GSa/s	500 Mpts (optional)	-	√
DHO1000	2/4	-	2 GSa/s	100 Mpts (opt.)	-	√
DS70000	4	-	20 GSa/s	2 Gpts	-	√
MSO8000/A	4	16	10 GSa/s	500 Mpts	√	√
DS8000-R	4	-	10 GSa/s	500 Mpts	√	√
MSO/DS7000	4	16 ^[1]	10 GSa/s	500 Mpts (optional)	√ ^[1]	√
MSO5000	2/4	16	4/8 GSa/s	100/200 Mpts (opt.)	√	√
MSO/DS2000A	2	16 ^[1]	2 GSa/s	56 Mpts (opt.)	√	√

Model	No. of Analog Channels	No. of Digital Channels	Max. Sample Rate	Max. Memory Depth	Signal Generator	Serial Bus Analysis
MSO/DS1000Z/Z-E	2/4	16 ^[2]	1 GSa/s	24 Mpts (opt.)	√	√

Model	Bandwidth (MHz)																			
	50	70	100	125	150	200	250	300	350	400	500	600	750	800	1,000	1500	2000	3000	5000	
DHO900	-	-	-	√	-	-	√	-	-	-	-	-	-	-	-	-	-	-	-	-
DHO800	-	√	√	-	-	-	-	-	-	-	-	-	-	-	-	-	-	-	-	-
DHO4000	-	-	-	-	-	√	-	-	-	√	-	-	-	√	-	-	-	-	-	-
DHO1000	-	√	√	-	-	√	-	-	-	-	-	-	-	-	-	-	-	-	-	-
DS70000	-	-	-	-	-	-	-	-	-	-	-	-	-	-	-	-	-	-	√	√
MSO8000/A	-	-	-	-	-	-	-	-	-	-	√	√	-	√	√	√	√	√	-	-
DS8000-R	-	-	-	-	-	-	-	-	√	-	-	-	-	-	√	-	√	-	-	-
MSO/DS7000	-	-	√	-	-	√	-	-	√	-	√	-	-	-	-	-	-	-	-	-
MSO5000	-	√	√	-	√	√	-	-	√	-	-	-	-	-	-	-	-	-	-	-
MSO/DS2000A	-	-	√	-	-	√	-	√	-	-	-	-	-	-	-	-	-	-	-	-
MSO/DS1000Z/Z-E	√	√	√	-	-	√	-	-	-	-	-	-	-	-	-	-	-	-	-	-

NOTE:

√ Std. or Opt. Supported.

[1] Options only supported by the MSO models.

[2] Only supported by the -E model.

[3] Only supported by the -S model.

DHO900 Series Digital Oscilloscope



DHO900 series is RIGOL's new launched high-performance economical digital oscilloscope. Compact in size, the DHO900 series features a capture rate up to 1,000,000 wfms/s (in UltraAcquire Mode), 50 Mpts, 12 bits resolution, and low noise.

The DHO900 series supports 16 digital channels. One instrument can make an analysis on both the analog and digital signals to meet the embedded design and test scenarios. With an affordable price equivalent to purchasing an entry-level instrument, you can access the auto serial and parallel bus analysis, bode plot analysis, and other functions to meet the test demands in the R&D, education, and scientific research fields.

- Ultra-low noise floor, purer signal, never miss the low-level signals
- Up to 12-bit resolution for all the models of this series
- Max. analog bandwidth of 250 MHz, 4 analog channels
- 16 digital channels (std.), logic analyzer probe required to be purchased if needed
- Max. real-time sample rate of 1.25 GSa/s
- Max. memory depth of 50 Mpts
- Vertical sensitivity range: 200 μ V/div to 10 V/div
- Max. capture rate of 1,000,000 wfms/s (in UltraAcquire mode)
- Max. phosphor display with real-time 256-level intensity grading
- Integrates the AFG function, bode plot analysis, histogram, digital signal analysis, and etc
- Waveform search and navigation function allows you to debug the signal anomalies faster
- 7" (1024x600) capacitive multi-touch screen
- User-friendly Flex Knobs design brings extraordinary user experience

- USB Device & Host, LAN, and HDMI interfaces (std.) for all the models of this series
- Support online version upgrade

Models and Specifications

Model	DHO914	DHO914S	DHO924	DHO924S
Analog Bandwidth (-3 dB)	125 MHz		250 MHz	
Rise Time (10% to 90%, typ.)	≤2.8 ns		≤1.4 ns	
No. of Input/Output Channels	4 input analog channels 16 input digital channels (required to purchase the PLA2216 logic analyzer probe) single-channel arbitrary function generator (AFG) output (only available for the S model)			
Sampling Mode	Real-time Sampling			
Vertical Resolution	12 bits			
Hardware Real-time Waveform Recording and Playing	Max. 500,000 frames			
Max. Sample Rate of Analog Channel	1.25 GSa/s (single-channel ^[1]), 625 MSa/s (dual-channel ^[2]), 312.5 MSa/s (full-channel ^[3])			
Max. Memory Depth	50 Mpts (single-channel ^[1]), 25 Mpts (dual-channel ^[2]), 10 Mpts (full-channel ^[3])			
Max. Waveform Capture Rate	30,000 wfms/s (Vector Mode) 1,000,000 wfms/s (UltraAcquire Mode)			
Vertical Sensitivity Range ^[4]	200 μV/div to 10 V/div			
DC Gain Accuracy ^[4]	±1% (>5 mV/div, full scale) ±2% (≤5 mV/div, full scale, typ.)			
Trigger Type	Standard: Edge trigger, Pulse trigger, Slope trigger, Video trigger, Pattern trigger, Duration trigger, Timeout trigger, Runt trigger, Window trigger, Delay trigger, Setup/Hold trigger, Nth Edge trigger, RS232/UART, I2C, SPI, CAN, and LIN			
Bus Decoding	Standard: Parallel, RS232/UART, I2C, SPI, LIN, and CAN			
Waveform Measurement	Qty.	41 auto measurements; and up to 10 measurements can be displayed at a time.		
	Analysis	Waveform recording, Pass/fail test, histogram, and color grade		
Waveform Calculation	A+B, A-B, AxB, A/B, FFT, A&&B, A B, A^B, !A, Intg, Diff, Lg, Ln, Exp, Sqrt, Abs, AX+B, LowPass, HighPass, BandPass, BandStop			
FFT	Record Length	Max. 1 Mpts (The max. number of the points to be analyzed for the FFT operation is 1 Mpts.)		
	Window Type	Rectangular, Blackman-Harris, Hanning (default), Hamming, Flattop, and Triangle.		
	Peak Search	A maximum of 15 peaks, determined by the user-defined threshold and offset threshold		

Model	DHO914	DHO914S	DHO924	DHO924S
LCD Size and Type	7" capacitive multi-touch screen			
Display Resolution	1024x600			
Weight ^[5]	Package excluded: 1.78 kg Package included: 2.78 kg			

NOTE:

[1]: Single-channel mode: If any one of the channels is enabled, it is called single-channel mode.

[2]: Dual-channel mode: If any two of the channels are enabled, it is called dual-channel mode.

[3]: Full-channel mode: If any three channels or all of the four channels are enabled, it is called full-channel mode.

[4]: 200 $\mu\text{V}/\text{div}$ and 500 $\mu\text{V}/\text{div}$ is a magnification of 1 mV/div setting. For vertical accuracy calculations, use full scale of 8 mV .

[5]: Standard configuration.

Order Information

Order Information	Order No.
Model	
DHO924S (250 MHz, 1.25 GSa/s, 50 Mpts, 4CH)	DHO924S
DHO924 (250 MHz, 1.25 GSa/s, 50 Mpts, 4CH)	DHO924
DHO914S (125 MHz, 1.25 GSa/s, 50 Mpts, 4CH)	DHO914S
DHO914 (125 MHz, 1.25 GSa/s, 50 Mpts, 4CH)	DHO914
Standard Accessories	
Power Adaptor Conforming to the Standard of the Destination Country	— —
DHO924/DHO924S: Passive Probe (350 MHz) x4	PVP2350
DHO914/DHO914S: Passive Probe (150 MHz) x4	PVP3150
Recommended Accessories	
16-channel Logic Analyzer Probe	PLA2216

NOTE:

For all the mainframes, accessories, and options, please contact the local office of RIGOL.

DHO800 Series Digital Oscilloscope



The DHO800 series is a brand new economical digital oscilloscope designed for the vast mainstream digital oscilloscope market to meet their design, debugging, and test demands.

DHO800 series is RIGOL's new launched high-performance economical digital oscilloscope. Compact in size, the DHO800 series features a capture rate up to 1,000,000 wfms/s (in UltraAcquire Mode), 25 Mpts, 12 bits, and low noise.

- Ultra-low noise floor, purer signal, never miss the low-level signals
- Up to 12-bit resolution for all the models of this series
- Max. analog bandwidth of 100 MHz, 4 analog channels, external trigger output (std.) available for the dual-channel model
- Max. real-time sample rate of 1.25 GSa/s
- Max. memory depth of 25 Mpts
- Vertical sensitivity range: 500 μ V/div to 10 V/div
- Max. capture rate of 1,000,000 wfms/s (in UltraAcquire mode)
- Max. phosphor display with real-time 256-level intensity grading
- Waveform search and navigation function allows you to debug the signal anomalies faster
- 7" (1024x600) capacitive multi-touch screen
- User-friendly Flex Knobs design brings extraordinary user experience
- USB Device & Host, LAN, and HDMI interfaces (std.) for all the models of this series
- Novel and delicate industrial design, easy to operate

- Support online version upgrade

Models and Specifications

Model	DHO802	DHO804	DHO812	DHO814
Analog Bandwidth (-3 dB)	70 MHz		100 MHz	
Rise Time (10% to 90%, typ.)	≤5 ns		≤3.5 ns	
No. of Analog Channels	2 + EXT	4	2 + EXT	4
Sampling Mode	Real-time Sampling			
Max. Sample Rate of Analog Channel	Two-channel model: 1.25 GSa/s (single-channel ^[1]), 625 MSa/s (full-channel ^[3]) four-channel model: 1.25 GSa/s (single-channel ^[1]), 625 MSa/s (dual-channel ^[2]), 312.5 MSa/s (full-channel ^[3])			
Max. Memory Depth	Two-channel model: 25 Mpts (single-channel ^[1]), 10 Mpts (full-channel ^[3]) four-channel model: 25 Mpts (single-channel ^[1]), 10 Mpts (dual-channel ^[2]), 1 Mpts (full-channel ^[3])			
Max. Waveform Capture Rate	30,000 wfms/s (Vector Mode) 1,000,000 wfms/s (UltraAcquire Mode)			
Vertical Sensitivity Range ^[4]	500 μV/div to 10 V/div			
Trigger Type	Standard: Edge trigger, Pulse trigger, Slope trigger, Video trigger, Pattern trigger, Duration trigger, Timeout trigger, Runt trigger, Window trigger, Delay trigger, Setup/Hold trigger, Nth Edge trigger, RS232/UART, I2C, and SPI			
Bus Decoding	Standard: Parallel, RS232/UART, I2C, and SPI			
DC Gain Accuracy ^[4]	±1% (>5 mV/div, full scale) ±2% (≤5 mV/div, full scale, typ.)			
Vertical Resolution	12 bits			
Hardware Real-time Waveform Recording and Playing	Max. 500,000 frames			
Waveform Measurement	Qty.	41 auto measurements; and up to 10 measurements can be displayed at a time.		
	Analysis	Waveform recording, Pass/fail test, histogram, and color grade		
Waveform Calculation	A+B, A-B, AxB, A/B, FFT, A&&B, A B, A^B, !A, Intg, Diff, Lg, Ln, Exp, Sqrt, Abs, AX +B, LowPass, HighPass, BandPass, BandStop			
FFT	Record Length	Max. 1 Mpts (The max. number of the points to be analyzed for the FFT operation is 1 Mpts.)		
	Window Type	Rectangular, Blackman-Harris, Hanning (default), Hamming, Flattop, and Triangle.		
	Peak Search	A maximum of 15 peaks, determined by the user-defined threshold and offset threshold		
Peak Detection	Capture 1.6 ns glitches			
LCD Size and Type	7" capacitive multi-touch screen			

Model	DHO802	DHO804	DHO812	DHO814
Display Resolution	1024x600			
Weight ^[5]	Package excluded: 1.78 kg Package included: 2.78 kg			

NOTE:

- [1]: Single-channel mode: If any one of the channels is enabled, it is called single-channel mode.
- [2]: Dual-channel mode: For four-channel models, if any two of the channels are enabled, it is called dual-channel mode.
- [3]: Full-channel mode: For two-channel models, if all of the two channels are enabled, it is called full-channel mode. For four-channel models, if any three channels or all of the four channels are enabled, it is called full-channel mode.
- [4]: 500 μ V/div is a magnification of 1 mV/div setting. For vertical accuracy calculations, use full scale of 8 mV.
- [5]: Standard configuration.

Order Information

Order Information	Order No.
Model	
DHO814 (100 MHz, 1.25 GSa/s, 25 Mpts, 4CH)	DHO814
DHO812 (100 MHz, 1.25 GSa/s, 25 Mpts, 2CH)	DHO812
DHO804 (70 MHz, 1.25 GSa/s, 25 Mpts, 4CH)	DHO804
DHO802 (70 MHz, 1.25 GSa/s, 25 Mpts, 2CH)	DHO802
Standard Accessories	
Power Adaptor Conforming to the Standard of the Destination Country	— —
DHO814/DHO804: Passive Probe (150 MHz) x4	PVP3150
DHO812/DHO802: Passive Probe (150 MHz) x2	

NOTE:

For all the mainframes, accessories, and options, please contact the local office of RIGOL.

DHO4000 Series Digital Oscilloscope



The DHO4000 series digital oscilloscope is designed to meet the designing, debugging, and testing requirements of the mainstream oscilloscope market. Built on RIGOL's "Centaurus" technical platform, this series delivers a fast waveform capture rate of 1,500,000 wfms/s in UltraAcquire mode, 500 Mpts memory depth, 12-bit vertical resolution, excellent noise floor performance and vertical accuracy to meet your requirements for more accurate measurements, bringing extraordinary T&M experience for you.

- Built on RIGOL's "Centaurus" technical platform
- Ultra-low noise floor: min. 18 μ Vrms
- 12-bit vertical resolution^[1]
- 200/400/800 MHz analog bandwidth (selectable), 4 analog channels, and 1 EXT channel
- Up to 4 GSa/s real-time sample rate
- Max. memory depth: 500 Mpts (optional)
- Min. vertical sensitivity: 100 μ V/div
- Up to 1,500,000 wfms/s waveform capture rate in UltraAcquire mode
- 10.1" 1280x800 HD touch display
- User-friendly Flex Knobs, bringing smoother interaction
- Standard photoelectric encoder operating knobs, effectively prolonging its service life
- Standard USB Device & Host, LAN, and HDMI interfaces
- Optional battery pack in a highly portable package for unlimited freedom from an AC power source
- Support online upgrade

NOTE:

[1]: 16 bits in High Resolution mode.

Models and Specifications

Model	DHO4204	DHO4404	DHO4804
Analog bandwidth (50 Ω , -3 dB)	200 MHz	400 MHz	800 MHz
Analog bandwidth (1 M Ω , -3 dB)	200 MHz	400 MHz	500 MHz
Range of Time Base	500 ns/div to 1 ks/div		
	Fine		
No. of Input Channels	4 analog channel inputs, 1 EXT channel input		
Max. Sample Rate of Analog Channel	4 GSa/s (single-channel ^[1]), 2 GSa/s (half-channel ^[2]), 1 GSa/s (full-channel ^[3])		
Max. Memory Depth	Standard: 250 Mpts (single-channel ^[1]), 125 Mpts (half-channel ^[2]), 62.5 Mpts (full-channel ^[3])		
	Option: 500 Mpts (single-channel ^[1]), 250 Mpts (half-channel ^[2]), 125 Mpts (full-channel ^[3])		
Max. Waveform Capture Rate	50,000 wfms/s (Vector Mode); 1,500,000 wfms/s (UltraAcquire Mode)		
Vertical Sensitivity Range ^[4]	1 M Ω	100 μ V/div to 10 V/div	
	50 Ω	100 μ V/div to 1 V/div	
DC Gain Accuracy ^[4]	\pm 2% of full scale		
Hardware Real-time Waveform Recording and Playing	Max. 500,000 frames		
Trigger Type	Standard: Edge trigger, Pulse trigger, Slope trigger, Video trigger, Pattern trigger, Duration trigger, Timeout trigger, Runt trigger, Window trigger, Delay trigger, Setup/ Hold trigger, and Nth Edge trigger, I2C, SPI, RS232/UART, and CAN Option: CAN-FD, LIN, FlexRay, I2S, and MIL-STD-1553		
Bus Decoding	Standard: Parallel, RS232/UART, I2C, SPI, CAN Option: LIN, CAN-FD, FlexRay, I2S, and MIL-STD-1553		
Waveform Measurement	41 auto measurements; and up to 14 measurements can be displayed at a time.		
Waveform Calculation	A+B, A-B, A \times B, A/B, FFT, A&&B, A B, A^B, !A, Intg, Diff, Sqrt, Lg, Ln, Exp, Abs, AX+B, LowPass, HighPass, BandPass, and BandStop		
Enhanced FFT	Record Length	Max. 1 Mpts	
	Window Type	Rectangular, Blackman-Harris, Hanning (default), Hamming, Flattop, and Triangle.	
	Peak Search	A maximum of 15 peaks, determined by the user-defined threshold and offset threshold	
I/O	USB3.0 Host, USB3.0 Device, LAN, Web Control, AUX Out, 10 MHz In/Out, HDMI, and Probe Compensation Output		
LCD Size and Type	10.1" capacitive multi-touch/gesture enabled operation		
Dimensions	358.14 mm (W) x 214.72 mm (H) x 120.62 mm (D)		
Weight ^[5]	Package excluded: 3.8 kg Package included: 5.37 kg		

NOTE:

[1]: Single-channel mode: If any one of the channels is enabled, it is called single-channel mode.

[2]: Dual-channel mode: For four-channel models, if any two of the channels are enabled, it is called dual-channel mode.

[3]: Full-channel mode: For two-channel models, if all of the two channels are enabled, it is called full-channel mode. For four-channel models, if any three channels or all of the four channels are enabled, it is called full-channel mode.

[4]: 100 $\mu\text{V}/\text{div}$, 200 $\mu\text{V}/\text{div}$, and 500 $\mu\text{V}/\text{div}$ are a magnification of 1 mV/div setting. For vertical accuracy calculations, use full scale of 8 mV.

[5]: Standard configuration.

Order Information

Order Information	Order No.
Model	
DHO4204 (200 MHz, 4 GSa/s, 250 Mpts, 4CH)	DHO4204
DHO4204 (400 MHz, 4 GSa/s, 250 Mpts, 4CH)	DHO4404
DHO4804 (800 MHz, 4 GSa/s, 250 Mpts, 4CH)	DHO4804
Standard Accessories	
Power Cord Conforming to the Standard of the Destination Country	— —
USB Cable	— —
DHO4204: Passive HighZ Probe (350 MHz, Std.) x4	PVP2350
DHO4404: Passive HighZ Probe (500 MHz, Std.) x4 DHO4804: Passive HighZ Probe (150 MHz, Std.) x4	RP3500A
Bandwidth Upgrade Option	
200 MHz-400 MHz Upgrade Option	DHO4000-BWU2T4
200 MHz-800 MHz Upgrade Option	DHO4000-BWU2T8
400 MHz-800 MHz Upgrade Option	DHO4000-BWU4T8
Memory Depth Upgrade Option	
500 Mpts Memory Depth Upgrade Option	DHO4000-RLU-05
Protocol Decoding Option	
CAN-FD/LIN Bus Trigger and Analysis Option	DHO4000-AUTOA
MIL-STD-1553 Bus Trigger and Analysis Option	DHO4000-AEROA
FlexRay Serial Bus Trigger and Analysis Option	DHO4000-FLEXA
I2S Bus Trigger and Analysis Option	DHO4000-AUDIOA
Optional Accessories	
Power Analysis Option	DHO4000-PWRA
Function and Application Bundle Option Including DHO4000-AUTOA/AEROA/FLEXA/AUDIOA/PWRA	DHO4000-BND

NOTE:

For all the mainframes, accessories, and options, please contact the local office of RIGOL.

DHO1000 Series Digital Oscilloscope



The DHO1000 series digital oscilloscope is designed to meet the designing, debugging, and testing requirements of the mainstream oscilloscope market. Built on RIGOL's "Centaurus" technical platform, this series delivers a fast waveform capture rate of 1,500,000 wfms/s in UltraAcquire mode, 100 Mpts memory depth, 12-bit vertical resolution, excellent noise floor performance and vertical accuracy to meet your requirements for more accurate measurements, bringing extraordinary T&M experience for you.

- Built on RIGOL's "Centaurus" technical platform
- Ultra-low noise floor for pure signals, measuring low level signals accurately
- 12-bit vertical resolution^[1]
- 70/100/200 MHz analog bandwidth (selectable), 2/4 analog channels, and 1 EXT channel
- Up to 2 GSa/s real-time sample rate
- Max. memory depth: 100 Mpts (optional)
- Vertical sensitivity range: 500 μ V/div to 10 V/div
- Up to 1,500,000 wfms/s waveform capture rate in UltraAcquire mode
- 10.1" 1280x800 HD touch display
- User-friendly Flex Knobs, bringing smoother interaction
- Standard photoelectric encoder operating knobs, effectively prolonging its service life
- Standard USB Device & Host, LAN, and HDMI interfaces

NOTE:

[1]: 16 bits in High Resolution mode.

Models and Specifications

Model	DHO1072	DHO1074	DHO1102	DHO1104	DHO1202	DHO1204
Analog Bandwidth (-3 dB)	70 MHz	70 MHz	100 MHz	100 MHz	200 MHz	200 MHz
No. of Input Channels	2 + EXT	4 + EXT	2 + EXT	4 + EXT	2 + EXT	4 + EXT
Range of Time Base	2 ns/div~1 ks/div Fine					
Max. Sample Rate of Analog Channel	Two-channel model: 1 GSa/s (single-channel ^[1]), 500 MSa/s (full-channel ^[3]) Four-channel model: 1 GSa/s (single-channel ^[1]), 500 MSa/s (half-channel ^[2]), 250 MSa/s (full-channel ^[3])					
Standard Memory Depth	Two-channel model: 50 Mpts (single-channel ^[1]), 25 Mpts (full-channel ^[3]) Four-channel model: 50 Mpts (single-channel ^[1]), 25 Mpts (half-channel ^[2]), 12.5 Mpts (full-channel ^[3])					
Optional Memory Depth	Two-channel model: 100 Mpts (single-channel ^[1]), 50 Mpts (full-channel ^[3]) Four-channel model: 100 Mpts (single-channel ^[1]), 50 Mpts (half-channel ^[2]), 25 Mpts (full-channel ^[3])					
Max. Waveform Capture Rate	50,000 wfms/s (Vector Mode); 1,500,000 wfms/s (UltraAcquire Mode)					
Vertical Sensitivity Range ^[4]	500 μ V/div to 10 V/div					
DC Gain Accuracy ^[4]	\pm 2% of full scale					
Hardware Real-time Waveform Recording and Playing	Max. 500,000 frames					
Trigger Type	Edge trigger, Pulse trigger, Slope trigger, Video trigger, Pattern trigger, Duration trigger, Timeout trigger, Runt trigger, Window trigger, Delay trigger, Setup/Hold trigger, and Nth Edge trigger, I2C, SPI, RS232/UART, CAN, and LIN					
Bus Decoding	Standard: Parallel, RS232/UART, I2C, SPI, LIN, and CAN					
Waveform Measurement	41 auto measurements; and up to 14 measurements can be displayed at a time.					
Waveform Calculation	A+B, A-B, A \times B, A/B, FFT, A&&B, A B, A^B, !A, Intg, Diff, Sqrt, Lg, Ln, Exp, Abs, AX+B, LowPass, HighPass, BandPass, and BandStop					
I/O	USB3.0 Host, USB3.0 Device, LAN, Web Control, AUX Out, 10 MHz In/Out, HDMI, and Probe Compensation Output					
LCD Size and Type	10.1-inch capacitive multi-touch screen, gesture enabled operation					
Dimensions	358.14 mm (W) \times 214.72 mm (H) \times 120.62 mm (D)					
Weight ^[5]	Package excluded: 3.8 kg Package included: 5.37 kg					
Enhanced FFT	Record Length	Max. 1 Mpts				
	Window Type	Rectangular, Blackman-Harris, Hanning (default), Hamming, Flattop, and Triangle.				
	Peak Search	A maximum of 15 peaks, determined by the user-defined threshold and offset threshold				

NOTE:

[1]: Single-channel mode: If any one of the channels is enabled, it is called single-channel mode.

[2]: Dual-channel mode: For four-channel models, if any two of the channels are enabled, it is called dual-channel mode.

[3]: Full-channel mode: For two-channel models, if all of the two channels are enabled, it is called full-channel mode. For four-channel models, if any three channels or all of the four channels are enabled, it is called full-channel mode.

[4]: 500 $\mu\text{V}/\text{div}$ is a magnification of 1 mV/div setting. For vertical accuracy calculations, use full scale of 8 mV.

[5]: Standard configuration.

Order Information

Order Information	Order No.
Model	
DHO1072 (70 MHz, 1 GSa/s, 50 Mpts, 2CH)	DHO1072
DHO1074 (70 MHz, 1 GSa/s, 50 Mpts, 4CH)	DHO1074
DHO1102 (100 MHz, 1 GSa/s, 50 Mpts, 2CH)	DHO1102
DHO1104 (100 MHz, 1 GSa/s, 50 Mpts, 4CH)	DHO1104
DHO1202 (200 MHz, 1 GSa/s, 50 Mpts, 2CH)	DHO1202
DHO1204 (200 MHz, 1 GSa/s, 50 Mpts, 4CH)	DHO1204
Standard Accessories	
Power Cord Conforming to the Standard of the Destination Country	— —
USB Cable x1	— —
DHO1204: Passive HighZ Probe (350 MHz, Std.) x4 DHO1202: Passive HighZ Probe (350 MHz, Std.) x2	PVP2350
DHO1104: Passive HighZ Probe (150 MHz, Std.) x4 DHO1074: Passive HighZ Probe (150 MHz, Std.) x4	PVP3150
DHO1102: Passive HighZ Probe (150 MHz, Std.) x2 DHO1072: Passive HighZ Probe (150 MHz, Std.) x2	PVP3150
Bandwidth Upgrade Option	
70 MHz-100 MHz Upgrade Option	DHO1000-BWU7T10
70 MHz-200 MHz Upgrade Option	DHO1000-BWU7T20
100 MHz-200 MHz Upgrade Option	DHO1000-BWU10T20
Memory Depth Upgrade Option	
100 Mpts Memory Depth Upgrade Option	DHO1000-RLU-01

NOTE:

For all the mainframes, accessories, and options, please contact the local office of RIGOL.

DS70000 Series Digital Oscilloscope

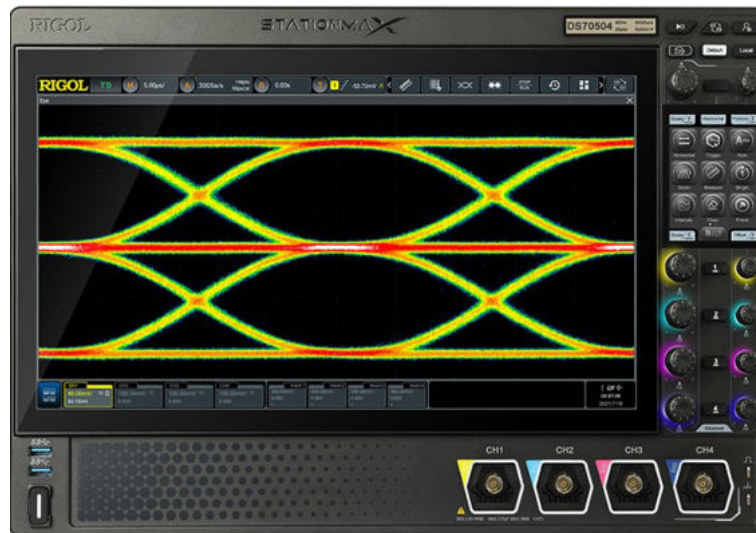

With RIGOL's brand new unique UltraVision III platform built on our custom ASIC technology, the DS70000 series digital oscilloscope delivers industry-leading performance specifications including memory depth, waveform capture rate, and vertical resolution. It supports analysis of serial data on computer, embedded, automotive, audio and additional bus types. UltraVision III also enables power integrity analysis as well as multi-domain debugging with simultaneous analysis of time-domain and frequency-domain signals. The DS70000 series fills an important need in high speed signal integrity and debugging from R&D to industrial applications with capabilities including:

- Bandwidth: 3 GHz and 5 GHz
- High-precision frequency counter and totalizer
- Protocol analyzer (opt.)
- 1 million wfms/s update rate capable of capturing rare signal anomalies that you might otherwise miss.
- Up to 2 Gpts of memory depth which makes long duration high speed captures possible.
- 8 to 16 bits adjustable vertical resolution capable of accurately measuring low level signals.
- Real-time spectrum analysis (RTSA, opt.) capable of capturing up to 10,000 FFTs per second so you don't miss small signal artifacts even in the RF domain.
- 4 analog channels and 1 EXT channel
- Up to 20 GSa/s real-time sample rate
- 3-digit DC/ACRMS, AC+DCRMS voltage measurement

16-bit vertical resolution

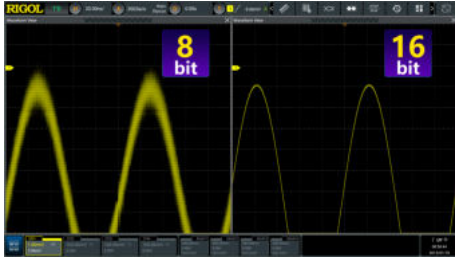

10,000 hardware accelerated FFTs/s with the RTSA option



Up to 2 Gpts memory depth

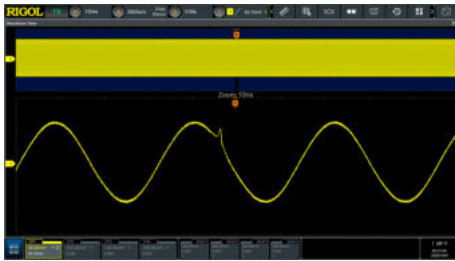

Multiple External Interfaces



Eye Analysis

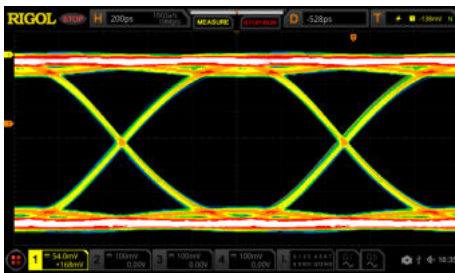

Brand New UI Design



After you have purchased the DS70000-JITTA option, the DS70000 series supports the eye measurement for all the analog channels, and also provides measurement for several parameters of the eye diagram: eye height, eye width, eye amplitude, crossing percentage, and Q Factor. It also supports various clock recovery methods, such as Constant (automatic, semi-automatic, and manual), First-order PLL, Second-order PLL, and Explicit, to meet the demands of customers for different application scenarios.

It has a delicate industry design, and it is a 7U full-rack structure that includes two touch screens. The main display is a 15.6-inch capacitive high definition touch screen with one button electronic tilt. Multi-pane windowing supports a variety of simultaneous analysis tools, making it easier to view signals, measurements, and results. Meanwhile, the secondary 3.5-inch touch screen separates menus and functions from signals and analysis with a customized function and shortcut menu.

Models and Specifications

Model	DS70504	DS70304
Analog bandwidth (50 Ω, -3 dB)	5 GHz	3 GHz
Analog bandwidth (1 MΩ, -3 dB)	500 MHz	

Model		DS70504	DS70304
No. of Input/Output Channels		4 analog channel inputs 1 EXT channel input	
Sampling Mode		Real-time Sampling	
Max. Sample Rate of Analog Channel		single-channel ^[1] : 20 GSa/s, half-channel ^[2] /full-channel ^[2] : 10 GSa/s	
Max. Memory Depth		Standard: 500 Mpts Option: 2 Gpts (single-channel ^[1]), 1 Gpts (half-channel ^[2] /all-channel)	
Max. Waveform Capture Rate ^[3]		≥1,000,000 wfms/s	
Hardware Real-time Waveform Recording and Playing		Max. 2,000,000 frames (single-channel)	
Range of Time Base		50 ps/div to 1 ks/div	100 ps/div to 1 ks/div
		Fine	
Vertical Sensitivity Range ^[4]	1 MΩ	1 mV/div to 10 V/div	
	50 Ω	1 mV/div to 1 V/div	
DC Gain Accuracy ^[4]		± 2% of full scale	
Trigger Type		Standard: Edge trigger, Pulse trigger, Slope trigger, Video trigger, Pattern trigger, Duration trigger, Timeout trigger, Runt trigger, Window trigger, Delay trigger, Setup/Hold trigger, Nth Edge trigger Option: RS232/UART, I2C, SPI, CAN, FlexRay, LIN, I2S, and MIL-STD-1553	
Bus Decoding		Standard: Parallel Option: RS232/UART, I2C, SPI, CAN, FlexRay, LIN, I2S, and MIL-STD-1553	
Waveform Measurement	Qty.	41 auto measurements; and up to 14 measurements can be displayed at a time.	
	Analysis	Frequency counter, DVM, power analysis (option), histogram, zone trigger, eye diagram (option), and jitter analysis (option)	
Waveform Calculation		A+B, A-B, A×B, A/B, FFT, A&&B, A B, A^B, !A, Intg, Diff, Sqrt, Lg, Ln, Exp, Abs, AX+B, LowPass, HighPass, BandPass, and BandStop	
Enhanced FFT	Record Length	Max. 1 Mpts	
	Window Type	Rectangular, Blackman-Harris, Hanning (default), Hamming, Flattop, and Triangle.	
	Peak Search	A maximum of 15 peaks, determined by the user-defined threshold and offset threshold	
I/O		USB3.0 Host, USB3.0 Device, LAN, web control, AUX reference clock, 10 MHz In/Out, HDMI, and Probe Compensation Output	
LCD Size and Type		15.6-inch capacitive multi-touch screen with one button electronic tilt/gesture enabled operation, 3.5-inch user-defined keyboard control touch screen	
Weight ^[5]		Package excluded: <22.5 kg Package included: <29.5 kg	

NOTE:

[1]: 5 GHz bandwidth is only applicable to single-channel mode. CH1 and CH2 are considered as a group; CH3 and CH4 are considered as another group. If one of the two channels in each group is enabled, it is called single-channel mode.

[2]: CH1 and CH2 are considered as a group; CH3 and CH4 are considered as another group. If two channels in either one of the groups are enabled, it is called half-channel mode.

[3]: Maximum value. single-channel, 5 ns horizontal time base, set a sine wave signal with 1 kpts memory depth, 4 div input amplitude, 10 MHz frequency. Others are default settings.

[4]: 1 mV/div and 2 mV/div are a magnification of 4 mV/div setting. For vertical accuracy calculations, use full scale of 32 mV for 1 mV/div and 2 mV/div sensitivity setting.

[5]: DS70000 model, standard configuration.

Order Information

Order Information		Order No.
Model		
DS70304 (3 GHz, 20 GSa/s, 500 Mpts, 4CH)		DS70304
DS70504 (5 GHz, 20 GSa/s, 500 Mpts, 4CH)		DS70504
Standard Accessories		
Power Cord Conforming to the Standard of the Destination Country		-
USB Cable x1		-
Passive HighZ Probe x4 (500 MHz)		RP3500A
Recommended Accessories		
Active Differential Probe (3.5 GHz BW)		PVA8350
Active Differential Probe (7 GHz BW)		PVA8700
Current Probe (50 MHz, 30 A)		PCA1030
Current Probe (100 MHz, 30 A)		PCA2030
Current Probe (10 MHz, 150 A)		PCA1150
High-voltage Differential Probe (70 MHz, 1500 V)		PHA0150
High-voltage Differential Probe (100 MHz, 1500 V)		PHA1150
USB-GPIB Adaptor		USB-GPIB
Bandwidth Upgrade Option		
2 Gpts Memory Depth Upgrade Option		DS70000-RL-20
Serial Protocol Analysis Option		
Embedded Serial Bus Trigger and Analysis (RS232/UART, I2C, and SPI)		DS70000-EMBDA
Auto Serial Bus Trigger and Analysis (CAN, CAN-FD, LIN, FlexRay)		DS70000-AUTOA
Audio Serial Bus Trigger and Analysis (I2S)		DS70000-AUDIOA
MIL-STD-1553 serial bus trigger and analysis		DS70000-AEROA
Measurement Application Option		
Advanced Eye Diagram and Jitter Analysis (Option)		DS70000-JITTA
Pre-compliance Test Software		
USB2.0 Compliance Test		DS70000-USBC
USB2.0 Compliance Test Fixture	HS Device Electrical Test Fixture (Differential), HS Device SQ Test Fixture (Single-ended)	TF-USB-D-STP
	HS Host SQ Test Fixture (Differential), USB-A HS Host SQ Test Fixture (Single-ended)	TF-USB-H-STP
1000 Base-T/100Base-T Ethernet Pre-compliance Test		DS70000-ENETC

Order Information		Order No.
1000 Base-T/100Base-T Ethernet Pre-compliance Test Fixture	Ethernet Test Fixture	TF-ENET-STP
Real-Time Spectrum Analysis (RTSA)		
Real-Time Spectrum Analysis Function		DS70000-RTSA

NOTE:

For all the mainframes, accessories, and options, please contact the local office of RIGOL.

MSO8000/A Series Digital Oscilloscope



MSO8000/A series digital oscilloscope adopts RIGOL's self-developed "Phoenix" technical platform, which can deliver up to 10 GSa/s sample rate, realizing the high integration of all the function modules required for the analog front-end (AFE), and greatly improving the consistency and reliability of the digital oscilloscope. The innovative UltraVision II platform makes the digital oscilloscope deliver a high waveform capture rate, full digital trigger technology, and full memory hardware measurement technology.

The MSO8000/A series digital oscilloscope also integrates other instrument modules, such as MSO, AWG, digital voltmeter, 6-digit counter and totalizer, and protocol analyzer, offering extraordinary user experience at an unprecedented price point.

- Up to 10 GSa/s real-time sample rate
- Up to 500 Mpts memory depth
- High waveform capture rate (over 600,000 wfm/s)
- Up to 450,000 frames of hardware real-time and ceaseless waveforms recording and playback
- 7-in-1 instrument
- 10.1" capacitive multi-touch screen, 256-level intensity grading display, with color persistence
- Web Control remote command supported
- Auto measurement of 41 waveform parameters; full-memory hardware measurement function
- Waveform histogram analysis (std.)

600,000 wfms/s waveform capture rate



Minimize the "dead time" between trigger, easy to observe the glitches and occurrence frequencies of the infrequent events, greatly improving the debugging efficiency

Full memory hardware measurement technology



No longer limited to the waveform effects visible on the screen. The results can still be accurately obtained for multi-period high-frequency signal testing.

Hardware Waveform Recording and Playback

Pass/Fail Test

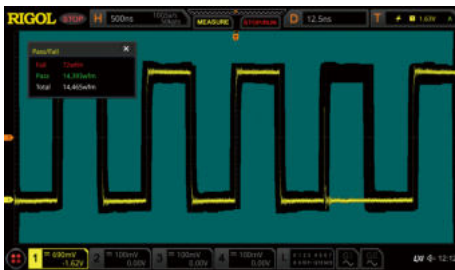

The MSO8000/A series is equipped with hardware pass/fail test function as the standard configuration, which can be used in signal monitoring for a long time, signal monitoring during design, and signal test in the production line.

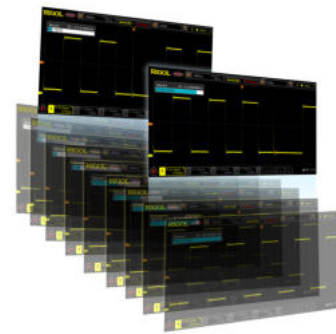

The MSO8000/A series provides ceaseless recording and playback for a maximum of 450,000 frames of hardware real-time waveforms. This specification is second to none in the industry.

Zone Trigger



User-defined One-key Quick Operation



Search and Navigation Function



Multiple External Interfaces



There is a dedicated Quick key, enabling you to customize the function of the key and complete the commonly used operation quickly. With the customized setting of the Quick key, you can quickly capture the screen image, realize waveform saving, setup saving, all measurement, reset measurement statistics, reset pass/fail test statistics, waveform recording, send the mail, printing, and group saving.

The series provides a variety of external interfaces, including USB HOST & DEVICE, LAN (LXI), HDMI, TRIG OUT, and USB-GPIB (opt.). The instrument is in compliance with the standards specified in LXI Device Specification 2011.

Models and Specifications

Model	MSO8064	MSO8104	MSO8204	MSO8074A	MSO8154A	MSO8204A
Analog bandwidth (50 Ω, -3 dB) ^[1]	600 MHz	1 GHz	2 GHz	750 MHz	1.5 GHz	2 GHz
Analog Bandwidth (1 MΩ, -3 dB)	500 MHz					
No. of Input/Output Channels	4 input analog channels 1 input EXT channel 16 input digital channels (required to purchase the RPL2316 logic analyzer probe) dual-channel arbitrary waveform generator output (required to purchase the MSO8000-AWG option)					
Max. Sample Rate of Analog Channel	Single-channel: 10 GSa/s, half-channel ^[2] : 5 Gsa/s, full-channel: 2.5 GSa/s Note: The max. bandwidth is different for different models under the max. sample rate of the analog channel ^[3] .					
Max. Memory Depth	Analog channel: 500 Mpts (single-channel), 250 Mpts (half-channel ^[2]), 125 Mpts (full-channel) Digital channel: 62.5 Mpts (full-channel)					
Max. Waveform Capture Rate ^[4]	≥600,000 wfms/s					
Hardware real-time waveform recording and playing	≥450,000 wfms (single-channel)					
Range of Time Base	600 MHz	1 GHz	2 GHz	750 MHz	1.5 GHz	2 GHz
	500 ps/div to 1 ks/div	500 ps/div to 1 ks/div	200 ps/div to 1 ks/div	500 ns/div to 1 ks/div	200 ns/div to 1 ks/div	200 ps/div to 1 ks/div
	Fine					
Vertical Sensitivity Range ^[5]	1 MΩ	1 mV/div to 10 V/div				
	50 Ω	1 mV/div to 1 V/div				
DC Gain Accuracy ^[5]	± 2% of full scale					
Trigger Type	Standard: Edge trigger, Pulse trigger, Slope trigger, Video trigger, Pattern trigger, Duration trigger, Timeout trigger, Runt trigger, Window trigger, Delay trigger, Setup/Hold trigger, Nth Edge trigger Option: RS232/UART, I2C, SPI, CAN, FlexRay, LIN, I2S, and MIL-STD-1553					
Bus Decoding	Standard: Parallel Option: RS232/UART, I2C, SPI, CAN, FlexRay, LIN, I2S, and MIL-STD-1553					

Model		MSO8064	MSO8104	MSO8204	MSO8074A	MSO8154A	MSO8204A
Waveform Measurement	Qty.	41 auto measurements; and up to 10 measurements can be displayed at a time.					
	Analysis	Frequency counter, DVM, power analysis (option), histogram, zone trigger, eye diagram (option), and jitter analysis (option)					
Waveform Calculation		A+B, A-B, A×B, A/B, FFT, A&&B, A B, A^B, !A, Intg, Diff, Sqrt, Lg, Ln, Exp, Abs, AX+B, LowPass, HighPass, BandPass, and BandStop					
Enhanced FFT	Record Length	Max. 1 Mpts					
	Window Type	Rectangular, Blackman-Harris, Hanning (default), Hamming, Flattop, and Triangle.					
	Peak Search	A maximum of 15 peaks, confirmed by the settable threshold and offset threshold set by users					
Arbitrary Waveform Generator		25 MHz, 2 CH (Required to purchase the AWG option)					
I/O		USB2.0 Host, USB2.0 Device, LAN, GPIB (opt.), web control, AUX output, 10 MHz In/Out, HDMI, and Probe Compensation Output					
LCD Size and Type		10.1-inch capacitive multi-touch screen/gesture enabled operation					
Weight ^[6]		Package excluded: <4.0 kg Package included: <9.2 kg					

NOTE:

[1]: 2 GHz bandwidth is only applicable to single-channel and half-channel modes. The three bandwidths of the 8000A series are available when the scale is 5 mV/div or above.

[2]: Half-channel mode: CH1 and CH2 are considered as a group; CH3 and CH4 are considered as another group. Each group share the sample rate of 5 GSa/s, and either one of the channels in each group is enabled.

[3]: The max. bandwidth for different models under the max. sample rate of the analog channel is shown in the following table.

Model		MSO8064	MSO8104	MSO8204	MSO8074A	MSO8154A	MSO8204A
Bandwidth	Single-channel	600 MHz	1 GHz	2 GHz	750 MHz	1.5 GHz	2 GHz
	half-channel	600 MHz	1 GHz	2 GHz	750 MHz	1.5 GHz	2 GHz
	Full-channel	600 MHz	1 GHz	1 GHz	750 MHz	1 GHz	1 GHz

[4]: Maximum value. single-channel, 10 ns horizontal time base, input amplitude 4 div, sine wave signal with 10 MHz frequency. Others are default settings.

[5]: 1 mV/div and 2 mV/div are a magnification of 4 mV/div setting. For vertical accuracy calculations, use full scale of 32 mV for 1 mV/div and 2 mV/div sensitivity setting.

[6]: MSO8000A model, standard configuration.

Order Information

Order Information	Order No.
Model	
MSO8204A (2 GHz, 10 GSa/s, 500 Mpts, 4+16 CH MSO)	MSO8204A

Order Information	Order No.
MSO8154A (1.5 GHz, 10 GSa/s, 500 Mpts, 4+16 CH MSO)	MSO8154A
MSO8074A (750 MHz, 10 GSa/s, 500 Mpts, 4+16 CH MSO)	MSO8074A
MSO8204 (2 GHz, 10 GSa/s, 500 Mpts, 4+16 CH MSO)	MSO8204
MSO8104 (1 GHz, 10 GSa/s, 500 Mpts, 4+16 CH MSO)	MSO8104
MSO8064 (600 MHz, 10 GSa/s, 500 Mpts, 4+16 CH MSO)	MSO8064
Standard Accessories	
USB Cable	CB-USBA-USBB-FF-150
Passive HighZ Probes x4 (500 MHz)	RP3500A
MSO8204A: Passive Low-impedance Probe x2 (1.5 GHz) MSO8154A: Passive Low-impedance Probe x2 (1.5 GHz)	RP6150A
Front Protective Cover	MSO8000-FPC
Power Cord Conforming to the Standard of the Destination Country	-
Recommended Accessories	
16-channel Logic Analyzer Probe	RPL2316
Active Single-ended/Differential Probe (2.5 GHz BW)	PVA7250
Active Differential Probe (1.5 GHz BW)	RP7150
Active Differential Probe (800 MHz BW)	RP7080
Active Single-ended Probe (1.5 GHz BW)	RP7150S
Active Single-ended Probe (800 MHz BW)	RP7080S
Rack Mount Kit	RM6041
Near-field Probe	NFP-3
Power Analysis Phase Difference Correction Jig	RPA246
Digital Oscilloscope Demonstration Plate	DK-DS6000
USB-GPIB Adaptor	USB-GPIB
Bandwidth Upgrade Option	
Bandwidth upgrades from 750 MHz to 1.5 GHz	MSO8000A-BW7T15
Bandwidth upgrades from 750 MHz to 2 GHz	MSO8000A-BW7T20
Bandwidth upgrades from 1.5 GHz to 2 GHz	MSO8000A-BW15T20
Single-Channel 3 GHz Bandwidth Upgrade Option	MSO8000A-BW20T30
Bandwidth upgrades from 600 MHz to 1 GHz	MSO8000-BW6T10
Bandwidth upgrades from 600 MHz to 2 GHz	MSO8000-BW6T20
Bandwidth upgrades from 1 GHz to 2 GHz	MSO8000-BW10T20
Bundle Option	
Function and application bundle option, including MSO8000-COMP, MSO8000-EMBD, MSO8000-AUTO, MSO8000-FLEX, MSO8000-AUDIO, MSO8000-AERO, MSO8000-AWG, MSO8000-JITTER and MSO8000-PWR	MSO8000-BND
Serial Protocol Analysis Option	
PC Serial Bus Trigger and Analysis (RS232/UART)	MSO8000-COMP
Embedded Serial Bus Trigger and Analysis (I2C, SPI)	MSO8000-EMBD

Order Information	Order No.
Auto Serial Bus Trigger and Analysis (CAN, LIN)	MSO8000-AUTO
FlexRay Serial Bus Trigger and Analysis (FlexRay)	MSO8000-FLEX
Audio Serial Bus Trigger and Analysis (I2S)	MSO8000-AUDIO
MIL-STD-1553 Serial Bus Trigger and Analysis (MIL-STD-1553)	MSO8000-AERO
Measurement Application Option	
Dual-channel 25 MHz Arbitrary Waveform Generator	MSO8000-AWG
Built-in Power Analysis (Required to Purchase the RPA246 Phase Deviation Correction Jig)	MSO8000-PWR
Real-time Eye Diagram and Jitter Analysis	MSO8000-JITTER

NOTE:

For all the accessories and options, please contact the local office of RIGOL.

DS8000-R Series Digital Oscilloscope



DS8000-R series is a medium and high-end digital oscilloscope with a compact size designed on the basis of RIGOL's UltraVision II technical platform built on the ASIC technology. It is compact and thin in design. It supports system integration of multiple devices. Its rack mount and remote system operation can meet the system requirements for industrial automation test system. DS8000-R series oscilloscope has an analog bandwidth of up to 2 GHz, supporting multi-device synchronous triggering, available to be extended to 512 channels. It provides an excellent solution for users to meet their medium and high-speed requirement for the system integration test and synchronization requirement for multi-channel data acquisition.

- Analog channel bandwidth: 2 GHz, 1 GHz and 350 MHz
- Up to 10 GSa/s real-time sample rate per channel for DS8104-R and DS8204-R; up to 5 GSa/s real-time sample rate for DS8034-R
- 4 analog channels, 1 EXT Input channel
- Standard memory depth up to 500 Mpts
- Web control remote command supported
- High waveform capture rate (over 600,000 wfm/s)
- Low jitter, multiple-device synchronization (<200 pS_{RMS}, typ.)
- Integrates 6 independent instruments into 1, including digital oscilloscope, spectrum analyzer, arbitrary waveform generator (option), digital voltmeter, 6-digit frequency counter and totalizer, and protocol analyzer (option)
- Extend up to 512 channels, supporting synchronous acquisition (with the synchronization module)
- Real-time eye diagram and jitter analysis software (option for DS8104-R/DS8204-R)

- Built-in advanced power analysis software (option)
- Operating temperature -40°C or above, available to be used for signal monitoring in some special conditions

Compact installation to save room

600,000 wfms/s waveform capture rate



Waveform capture rate up to 600,000 wfms/s, capable of finding the glitches and infrequent events from the waveforms; 256-level intensity grading display shows the frequency of the occurrence of the occasional events.

The standard configuration of rack mount kit helps customers to quickly set up the multi-device integration environment system.

Remote control

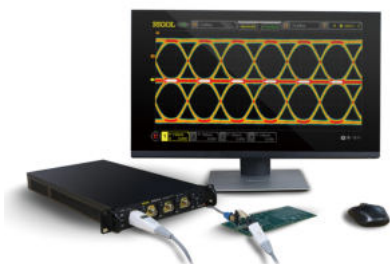

Multiple external interfaces



Input the IP address of the oscilloscope into the address bar of the Web browser to open the Web Control software. The display of the waveform interface and instrument control in the software are consistent with that in the DS8000-R series. You can use the mouse to click the menus in the Web Control interface function key to realize waveform control, measurement, and analysis. In the Web Control interface, you can click to view the basic information of the instrument, and you can also set or modify the network status.

Multiple interfaces available: USB HOST & USB DEVICE, LAN(LXI), HDMI, TRIG OUT, 10 MHz IN, 10 MHz OUT, and GPIB (opt.) via the USB-GPIB adaptor. The oscilloscope is in compliance with the standards specified in LXI Device Specification 2011. It can access to the LXI webpage via the LAN interface. You can purchase the USB-GPIB adaptor from RIGOL to enjoy the reliable GPIB communication service. It also provides HDMI video output interface.

Models and Specifications

Model	DS8104-R	DS8204-R	DS8034-R
Analog bandwidth (50 Ω, -3 dB) ^[1]	1 GHz	2 GHz	350 MHz
Analog bandwidth (1 MΩ, -3 dB)	500 MHz	500 MHz	350 MHz

Model	DS8104-R	DS8204-R	DS8034-R
Range of Time Base	500 ns/div~1 ks/div		
	Fine		
No. of Input Channels	4 analog channel inputs, 1 EXT channel input		
Max. Sample Rate of Analog Channel	DS8104-R/DS8204-R: 10 GSa/s (single-channel), 5 GSa/s (half-channel ^[2]), 2.5 GSa/s (full-channel) DS8034-R: 5 GSa/s (single-channel), 5 GSa/s (half-channel ^[2]), 2.5 GSa/s (full-channel) Note: When all the channels are enabled, the sample rate is 2.5 GSa/s, and the analog bandwidth can reach up to 1 GHz.		
Max. Memory Depth	Analog channel: 500 Mpts (single-channel), 250 Mpts (half-channel ^[2]), 125 Mpts (full-channel)		
Max. Waveform Capture Rate ^[3]	≥600,000 wfms/s		
Vertical Sensitivity Range ^[4]	1 MΩ	1 mV/div~10 V/div	
	50 Ω	1 mV/div~1 V/div	
DC Gain Accuracy ^[4]	± 2% of full scale		
Hardware Real-time Waveform Recording and Playing	≥450,000 wfms (single-channel)		
Trigger Type	Standard: Edge trigger, Pulse trigger, Slope trigger, Video trigger, Pattern trigger, Duration trigger, Timeout trigger, Runt trigger, Window trigger, Delay trigger, Setup/Hold trigger, Nth Edge trigger Option: RS232/UART, I2C, SPI, CAN, FlexRay, LIN, I2S, and MIL-STD-1553		
Bus Decoding	Standard: Parallel Option: RS232/UART, I2C, SPI, CAN, LIN, CAN-FD, FlexRay, I2S, and MIL-STD-1553		
Waveform Measurement	41 auto measurements; and up to 10 measurements can be displayed at a time.		
Waveform Calculation	A+B, A-B, AxB, A/B, FFT, A&&B, A B, A^B, !A, Intg, Diff, Lg, Ln, Exp, Sqrt, Abs, AX+B, LowPass, HighPass, BandPass, BandStop, and Trend		
Enhanced FFT	Record Length	Max. 1 Mpts	
	Window Type	Rectangular, Blackman-Harris, Hanning (default), Hamming, Flattop, and Triangle.	
	Peak Search	A maximum of 15 peaks, determined by the user-defined threshold and offset threshold	
I/O	USB2.0 Host, USB2.0 Device, LAN, GPIB, Web Control, AUX Out, 10 MHz In/Out, HDMI, and Probe Compensation Output		
Dimensions	Without handles and hanging ears: 214mm (W) x 43 mm (H) x 478 mm (D) With handles and hanging ears: 268mm (W) x 43 mm (H) x 499 mm (D)		
Weight ^[5]	Package excluded: <3.6 kg Package included: <7.1 kg		

NOTE:

[1]: 2 GHz bandwidth is only applicable to single-channel or half-channel mode.

[2]: Half-channel mode: CH1 and CH2 are considered as a group; CH3 and CH4 are considered as another group. Each group share the sample rate of 5 GSa/s, and either one of the channels in each group is enabled.

[3]: Maximum value. DS8104-R/DS8204-R: single-channel, memory depth Auto, 10 ns horizontal time base, input amplitude 4 div, sine wave signal with 10 MHz frequency. Others are default settings. For DS8034-R: single-channel, memory depth Auto, 20 ns/div horizontal time base, input amplitude 4 div, sine wave signal with 10 MHz frequency. Others are default settings.

[4]: 1 mV/div and 2 mV/div are a magnification of 4 mV/div setting. For vertical accuracy calculations, use full scale of 32 mV for 1/div and 2 mV/div sensitivity setting.

[5]: DS8000-R model, standard configuration.

Order Information

Order Information	Order No.
Model	
DS8204-R (2 GHz, 10 GSa/s, 500 Mpts, 4CH compact digital oscilloscope)	DS8204-R
DS8104-R (1 GHz, 10 GSa/s, 500 Mpts, 4CH compact digital oscilloscope)	DS8104-R
DS8034-R (350 MHz, 5 GSa/s, 500 Mpts, 4CH compact digital oscilloscope)	DS8034-R
Standard Accessories	
Power Cord Conforming to the Standard of the Destination Country	-
USB Cable	CB-USBA-USBB-FF-150
Rack Mount Kit	RM1011 & RM1012
Recommended Accessories	
Passive High-impedance Probe (500 MHz BW)	RP3500A
Passive High-impedance Probe (350 MHz BW)	PVP2350
Passive Low-impedance Probe (1.5 GHz BW)	RP6150A
Active Single-ended/Differential Probe (2.5 GHz BW)	PVA7250
Active Differential Probe (1.5 GHz BW)	RP7150
Active Differential Probe (800 MHz BW)	RP7080
Active Single-ended Probe (1.5 GHz BW)	RP7150S
Active Single-ended Probe (800 MHz BW)	RP7080S
50 Ω impedance matching device (2 W, 1 GHz)	ADP0150BNC
Power Analysis Phase Difference Correction Jig	RPA246
64CH Synchronization Module	DS SYNC64
2-Way Power Splitter (DC to 4 GHz)	PRSC42
Software Tool	
Software Development Kit (Open Source, Available to Download from RIGOL official website)	-
Bundle Option	
Function and Application Bundle Option, including DS8000-R-COMP, DS8000-R-EMBD, DS8000-R-AUTO, DS8000-R-FLEX, DS8000-R-AUDIO, DS8000-R-AERO, DS8000-R-AWG, DS8000-R-JITTER, and DS8000-R-PWR	DS8000-R-BND
Serial Protocol Analysis Option	
PC Serial Bus Trigger and Analysis (RS232/UART)	DS8000-R-COMP
Embedded Serial Bus Trigger and Analysis (I2C, SPI)	DS8000-R-EMBD
Auto Serial Bus Trigger and Analysis (CAN, LIN)	DS8000-R-AUTO
FlexRay Serial Bus Trigger and Analysis (FlexRay)	DS8000-R-FLEX

Order Information	Order No.
Audio Serial Bus Trigger and Analysis (I2S)	DS8000-R-AUDIO
MIL-STD-1553 Serial Bus Trigger and Analysis (MIL-STD-1553)	DS8000-R-AERO
Measurement Application Option	
Dual-channel 25 MHz Arbitrary Waveform Generator	DS8000-R-AWG
Built-in Power Analysis (Required to Purchase the RPA246 Phase Deviation Correction Jig)	DS8000-R-PWR
Real-time Eye Diagram and Jitter Analysis (Only Available for DS8104-R and DS8204-R)	DS8000-R-JITTER

NOTE:

For all the mainframes, accessories, and options, please contact the local office of RIGOL.

MSO/DS7000 Series Digital Oscilloscope

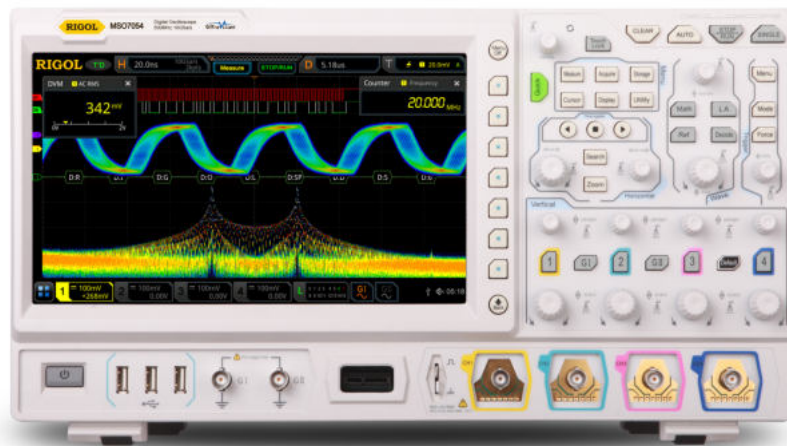

MSO7000/DS7000 series digital oscilloscope adopts RIGOL's self-developed "Phoenix" technical platform, which can deliver up to 10 GSa/s sample rate, realizing the high integration of all the function modules required for the analog front-end (AFE), and greatly improving the consistency and reliability of the digital oscilloscope. The 1 M Ω -path digital input attenuator can switch the scale rapidly and quietly. The unique circuit design shortens the overload recovery time of the 1 M Ω -mode to 0.5% of that of the existing products. This is the first time for a Chinese enterprise to launch the ASIC platform, which is of great strategic significance in the global electronic test and measurement instrument industry.

- Analog bandwidth: 500 MHz, 350 MHz, 200 MHz, and 100 MHz; bandwidth upgrade supported
- Unique online upgrade
- Up to 10 GSa/s real-time sample rate per channel (5 GSa/s real-time sample rate for the 100 MHz model)
- Up to 500 Mpts memory depth
- High waveform capture rate (over 600,000 wfm/s)
- Up to 450,000 frames of hardware real-time and ceaseless waveforms recording and playback
- 6-in-1 instrument
- 10.1" capacitive multi-touch screen, 256-level intensity grading display, with color persistence
- Web Control remote command supported
- Auto measurement of 41 waveform parameters; full-memory hardware measurement function
- Waveform histogram analysis (std.)

600,000 wfms/s waveform capture rate



Minimize the "dead time" between trigger, easy to observe the glitches and occurrence frequencies of the infrequent events, greatly improving the debugging efficiency

Full memory hardware measurement technology



Full-memory hardware measurement enables you to observe and accurately measure two signals with great frequency deviations.

Pass/Fail test



The MSO7000/DS7000 series is equipped with hardware pass/fail test function as the standard configuration, which can be used in signal monitoring for a long time, signal monitoring during design, and signal test in the production line.

Hardware waveform recording and playback



With the segmented storage technology, you can set the trigger conditions to make a selective choice in capturing and saving the signals that you are interested in, then mark the time on the signal.

A variety of protocol decodes



The zone trigger works together with other 20 trigger types. The decoding, waveform recording, and pass/fail test functions are also supported. This is conducive to the debugging of the complex signals.

Histogram analysis



The histogram enables users to observe the measurement results of signal variation in a long period of time, helping them locate the potential abnormalities of the signal.

Models and Specifications

Model	MSO/DS7014	MSO/DS7024	MSO/DS7034	MSO/DS7054
Analog Bandwidth	100 MHz	200 MHz	350 MHz	500 MHz

Model		MSO/DS7014	MSO/DS7024	MSO/DS7034	MSO/DS7054
No. of Input/Output Channels		4 input analog channels 1 input EXT channel 16 input digital channels (only available for the MSO model) 2CH arbitrary waveform generator output (opt. Only available for the MSO model)			
Max. Sample Rate of Analog Channel		Single-channel: 10 GSa/s, half-channel ^[1] : 5 GSa/s, full-channel: 2.5 GSa/s			
Max. Memory Depth		Analog channel: 500 Mpts (single-channel), 250 Mpts (half-channel ^[1]), 125 Mpts (full-channel) Digital channel: 62.5 Mpts (full-channel)			
Max. Waveform Capture Rate ^[2]		≥600,000 wfms/s			
Hardware real-time waveform recording and playing		≥450,000 wfms (single-channel)			
Range of Time Base		100 MHz	200 MHz	350 MHz	500 MHz
		5 ns/div to 1 ks/div	2 ns/div to 1 ks/div	1 ns/div to 1 ks/div	500 ps/div to 1 ks/div
		Fine			
Vertical Sensitivity Range ^[3]	1 MΩ	500 μV/div to 10 V/div			
	50 Ω	500 μV/div to 1 V/div			
DC Gain Accuracy ^[3]		±2% of full scale			
Trigger Type		Standard: Edge trigger, Pulse trigger, Slope trigger, Video trigger, Pattern trigger, Duration trigger, Timeout trigger, Runt trigger, Window trigger, Delay trigger, Setup/Hold trigger, Nth Edge trigger Option: RS232/UART, I2C, SPI, CAN, FlexRay, LIN, I2S, and MIL-STD-1553			
Bus Decoding		Standard: Parallel Option: RS232/UART, I2C, SPI, CAN, FlexRay, LIN, I2S, and MIL-STD-1553			
Waveform Measurement	Qty.	41 auto measurements; and up to 10 measurements can be displayed at a time.			
	Analysis	Frequency counter, DVM, power analysis (opt.), histogram			
Waveform Calculation		A+B, A-B, AxB, A/B, FFT, A&&B, A B, A^B, !A, Intg, Diff, Lg, Ln, Exp, Sqrt, Abs, AX+B, LowPass, HighPass, BandPass, and BandStop			
Enhanced FFT	Record Length	Max. 1 Mpts			
	Window Type	Rectangular, Blackman-Harris, Hanning (default), Hamming, Flattop, and Triangle.			
	Peak Search	A maximum of 15 peaks, determined by the user-defined threshold and offset threshold			
Arbitrary Waveform Generator		25 MHz, 2CH			
I/O		USB2.0 Host, USB2.0 Device, LAN, GPIB, web control, AUX Out, HDMI, and Probe Compensation Output			
LCD Size and Type		10.1" capacitive multi-touch screen/gesture enabled operation			
Weight ^[4]		Package excluded: <3.9 kg Package included: <7.1 kg			

NOTE:

[1]: Half-channel mode: CH1 and CH2 are considered as a group; CH3 and CH4 are considered as another group. Each group share the sample rate of 5 GSa/s, and either one of the channels in each group is enabled.

[2]: Maximum value. single-channel, 10 ns horizontal time base, input amplitude 4 div, sine wave signal with 10 MHz frequency. Others are default settings.

[3]: 1 mV/div and 2 mV/div are a magnification of 4 mV/div setting. For vertical accuracy calculations, use full scale of 32 mV for 1/div and 2 mV/div sensitivity setting.

[4]: MSO/DS7000 model, standard configuration.

Order Information

Order Information	Order No.
Model	
MSO7054 (500 MHz, 10 GSa/s, 100 Mpts, 4+16 CH MSO)	MSO7054
MSO7034 (350 MHz, 10 GSa/s, 100 Mpts, 4+16 CH MSO)	MSO7034
MSO7024 (200 MHz, 10 GSa/s, 100 Mpts, 4+16 CH MSO)	MSO7024
MSO7014 (100 MHz, 10 GSa/s, 100 Mpts, 4+16 CH MSO)	MSO7014
DS7054 (500 MHz, 10 GSa/s, 100 Mpts, 4CH DS)	DS7054
DS7034 (350 MHz, 10 GSa/s, 100 Mpts, 4CH DS)	DS7034
DS7024 (200 MHz, 10 GSa/s, 100 Mpts, 4CH DS)	DS7024
DS7014 (100 MHz, 10 GSa/s, 100 Mpts, 4CH DS)	DS7014
Standard Accessories	
USB Cable	CB-USBA-USBB-FF-150
Passive HighZ Probe x4 (500 MHz)	RP3500A
Logic Analyzer Probe x1 (only for the MSO model)	RPL2316
Front Protective Cover	DS7000-FPC
Power Cord Conforming to the Standard of the Destination Country	-
Recommended Accessories	
Active Differential Probe (1.5 GHz BW)	RP7150
Active Differential Probe (800 MHz BW)	RP7080
Active Single-ended Probe (1.5 GHz BW)	RP7150S
Active Single-ended Probe (800 MHz BW)	RP7080S
Rack Mount Kit	RM6041
Near-field Probe	NFP-3
Power Analysis Phase Difference Correction Jig	RPA246
Digital Oscilloscope Demonstration Plate	DK-DS6000
USB-GPIB Adaptor	USB-GPIB
Bandwidth Upgrade Option	
Bandwidth Upgrades from 100 MHz to 200 MHz	DS7000-BW1T2
Bandwidth Upgrades from 100 MHz to 350 MHz	DS7000-BW1T3

Order Information	Order No.
Bandwidth Upgrades from 100 MHz to 500 MHz	DS7000-BW1T5
Bandwidth Upgrades from 200 MHz to 350 MHz	DS7000-BW2T3
Bandwidth Upgrades from 200 MHz to 500 MHz	DS7000-BW2T5
Bandwidth Upgrades from 350 MHz to 500 MHz	DS7000-BW3T5
Memory Depth Option	
250 Mpts Memory Depth	DS7000-2RL
500 Mpts Memory Depth	DS7000-5RL
Bundle Option	
Function and Application Bundle Option, including DS7000-COMP, DS7000-EMBD, DS7000-AUTO, DS7000-FLEX, DS7000-AUDIO, DS7000-AERO, MSO7000-AWG, and DS7000-PWR	DS7000-BND
Serial Protocol Analysis Option	
PC Serial Bus Trigger and Analysis (RS232/UART)	DS7000-COMP
Embedded Serial Bus Trigger and Analysis (I2C and SPI)	DS7000-EMBD
Auto Serial Bus Trigger and Analysis (CAN and LIN)	DS7000-AUTO
FlexRay Serial Bus Trigger and Analysis (FlexRay)	DS7000-FLEX
Audio Serial Bus Trigger and Analysis (I2S)	DS7000-AUDIO
MIL-STD-1553 Serial Bus Trigger and Analysis (MIL-STD-1553)	DS7000-AERO
Measurement Application Option	
Dual-channel 25 MHz Arbitrary Waveform Generator (only for the MSO model)	MSO7000-AWG
Built-in Power Analysis	DS7000-PWR

NOTE:

For all the accessories and options, please contact the local office of RIGOL.

MSO5000 Series Digital Oscilloscope



MSO5000 series digital oscilloscope is a high-performance oscilloscope model designed with RIGOL UltraVision II technology. With a 9-inch capacitive multi-touch screen, the MSO5000 series integrates 7 independent instruments into one, delivering super sample bandwidth ratio, extremely high memory depth, and other excellent specifications. Though compact and portable in design, all of the MSO5000 series products can upgrade their channels, bandwidths, and the analysis software. The instrument can be customized for different user groups based on their different needs, helping them save their budget to a large extent while enjoying the superior test support and user experience.

- Analog bandwidth: 350 MHz, 200 MHz, 100 MHz, and 70 MHz; bandwidth upgrade supported
- Unique online upgrade
- Up to 8 GSa/s real-time sample rate
- Up to 100 Mpts memory depth
- >500,000 wfm/s waveform capture rate
- Up to 450,000 frames of hardware real-time and ceaseless waveforms recording and playback
- 7-in-1 instrument
- 9" capacitive multi-touch screen, 256-level intensity grading display, with color persistence
- Web Control remote command supported
- Auto measurement of 41 waveform parameters; full-memory hardware measurement function
- Built-in advanced power analysis software (opt.)

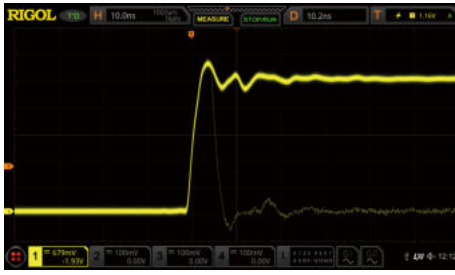

500,000 wfms/s waveform capture rate



Full memory hardware measurement technology



Support up to 450,000 frames of real-time and ceaseless waveforms

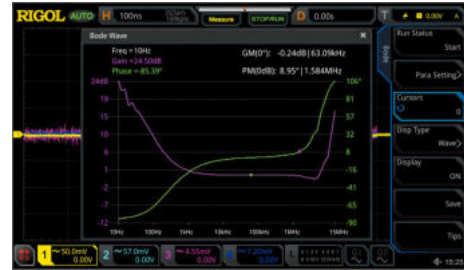

Bode plot



A variety of trigger and protocol decodings



Power analysis (opt.)

Models and Specifications

Model	MSO5072	MSO5074	MSO5102	MSO5104	MSO5204	MSO5354
Analog Bandwidth	70 MHz	70 MHz	100 MHz	100 MHz	200 MHz	350 MHz
No. of Input Channels	2	4	2	4	4	4
	16 input digital channels (required to purchase the PLA2216 logic analyzer probe) dual-channel arbitrary waveform generator output (required to install the MSO5000-AWG option to activate)					
Range of Time Base	5 ns/div to 1 ks/div	5 ns/div to 1 ks/div	5 ns/div to 1 ks/div	5 ns/div to 1 ks/div	2 ns/div to 1 ks/div	1 ns/div to 1 ks/div
	Fine					
Max. Sample Rate of Analog Channel	MSO5354/MSO5204/MSO5104/MSO5074: 8 GSa/s (single-channel), 4 GSa/s (half-channel ^[1]), 2 GSa/s (full-channel) MSO5102/MSO5072: 8 GSa/s (single-channel), 2 GSa/s (full-channel)					

Model		MSO5072	MSO5074	MSO5102	MSO5104	MSO5204	MSO5354
Max. Memory Depth	Option 2RL	Analog channel: 200 Mpts (single-channel), 100 Mpts (half-channel ^[1]), 50 Mpts (full-channel)					
		Digital channel: 25 Mpts (full-channel)					
Max. Waveform Capture Rate ^[2]		≥500,000 wfms/s					
Vertical Sensitivity Range ^[3]		500 μV/div to 10 V/div					
DC Gain Accuracy ^[3]		±3% of full scale					
Hardware Real-time Waveform Recording and Playing		≥450,000 wfms (single-channel)					
Trigger Type		Standard: Edge trigger, Pulse trigger, Slope trigger, Video trigger, Pattern trigger, Duration trigger, Timeout trigger, Runt trigger, Window trigger, Delay trigger, Setup/Hold trigger, Nth Edge trigger Option: RS232/UART, I2C, SPI, CAN, FlexRay, LIN, I2S, and MIL-STD-1553					
Bus Decoding		Standard: Parallel Option: RS232/UART, I2C, SPI, LIN, CAN, FlexRay, I2S, and MIL-STD-1553					
Waveform Measurement		41 auto measurements; and up to 10 measurements can be displayed at a time.					
Waveform Calculation		A+B, A-B, AxB, A/B, FFT, A&&B, A B, A^B, !A, Intg, Diff, Lg, Ln, Exp, Sqrt, Abs, AX+B, LowPass, HighPass, BandPass, BandStop					
I/O		USB2.0 Host, USB2.0 Device, LAN, GPIB, Web Control, AUX Out, HDMI, and Probe Compensation Output					
LCD Size and Type		9" capacitive multi-touch screen/gesture enabled operation					
Dimensions ^[4]		367mm (W) x 200 mm (H) x 130 (D)					
Weight ^[5]		Package excluded: <3.5 kg					
		Package included: < 5.8 kg					
Enhanced FFT	Record Length	Max. 1 Mpts					
	Window Type	Hanning (default), Blackman-Harris, Rectangular, Hamming, Flattop, and Triangle.					
	Peak Search	A maximum of 15 peaks, determined by the user-defined threshold and offset threshold					

NOTE:

[1]: Half-channel mode: CH1 and CH2 are considered as a group; CH3 and CH4 are considered as another group. Each group share the same ADC sample, and either one of the channels in each group is enabled.

[2]: Maximum value. single-channel, 10 ns horizontal time base, input amplitude 4 div, sine wave signal with 10 MHz frequency. Others are default settings.

[3]: 1 mV/div and 2 mV/div are a magnification of 4 mV/div setting. For vertical accuracy calculations, use full scale of 32 mV for 1/div and 2 mV/div sensitivity setting.

[4]: Supporting legs and handle folded, knob height included, front protective cover excluded.

[5]: Standard configuration.

Order Information

Order Information	Order No.
Model	
MSO5354 (350 MHz, 8 GSa/s, 100 Mpts, 4+16 CH MSO)	MSO5354
MSO5204 (200 MHz, 8 GSa/s, 100 Mpts, 4+16 CH MSO)	MSO5204
MSO5104 (100 MHz, 8 GSa/s, 100 Mpts, 4+16 CH MSO)	MSO5104
MSO5102 (100 MHz, 8 GSa/s, 100 Mpts, 2+16 CH MSO)	MSO5102
MSO5074 (70 MHz, 8 GSa/s, 100 Mpts, 4+16 CH MSO)	MSO5074
MSO5072 (70 MHz, 8 GSa/s, 100 Mpts, 2+16 CH MSO)	MSO5072
Standard Accessories	
Power Cord Conforming to the Standard of the Destination Country	-
USB Cable x1	CB-USBA-USBB-FF-150
2 or 4 Passive Probes (350 MHz)	PVP2350
Optional Accessories	
16-channel Logic Analyzer Probe (dedicated probe for the MSO5000 series)	PLA2216
Front Protective Cover	MSO5000-FPC
Rack Mount Kit	MSO5000-RM
USB to GPIB Interface Converter	USB-GPIB
Near-field Probe	NFP-3
Power Analysis Phase Difference Correction Jig	RPA246
Digital Oscilloscope Demonstration Plate	DK-DS6000
Bandwidth Upgrade Option	
Bandwidth Upgrades from 70 MHz to 100 MHz	MSO5000-BW0T1
Bandwidth Upgrades from 70 MHz to 200 MHz	MSO5000-BW0T2
Bandwidth Upgrades from 70 MHz to 350 MHz	MSO5000-BW0T3
Bandwidth Upgrades from 100 MHz to 200 MHz	MSO5000-BW1T2
Bandwidth Upgrades from 100 MHz to 350 MHz	MSO5000-BW1T3
Bandwidth Upgrades from 200 MHz to 350 MHz	MSO5000-BW2T3
Memory Depth Upgrade Option	
200 Mpts Memory Depth	MSO5000-2RL
Channel Number Upgrade Option	
4CH (only available for the MSO5XX2 model)	MSO5000-4CH
Bundle Option	
Function and Application Bundle Option, including MSO5000-COMP, MSO5000-EMBD, MSO5000-AUTO, MSO5000-FLEX, MSO5000-AUDIO, MSO5000-AERO, MSO5000-AWG, and MSO5000-PWR	MSO5000-BND
Serial Protocol Analysis Option	
PC Serial Bus Trigger and Analysis (RS232/UART)	MSO5000-COMP
Embedded Serial Bus Trigger and Analysis (I2C and SPI)	MSO5000-EMBD
Auto Serial Bus Trigger and Analysis (CAN and LIN)	MSO5000-AUTO

Order Information	Order No.
FlexRay Serial Bus Trigger and Analysis (FlexRay)	MSO5000-FLEX
Audio Serial Bus Trigger and Analysis (I2S, only available for the MSO5XX4 model or the model installed with the MSO5000-4CH option)	MSO5000-AUDIO
MIL-STD-1553 Serial Bus Trigger and Analysis (MIL-STD-1553)	MSO5000-AERO
Measurement Application Option	
Dual-channel 25 MHz Arbitrary Waveform Generator	MSO5000-AWG
Built-in Power Analysis	MSO5000-PWR

NOTE:

For all the accessories and options, please contact the local office of RIGOL.

MSO/DS2000A Series Digital Oscilloscope

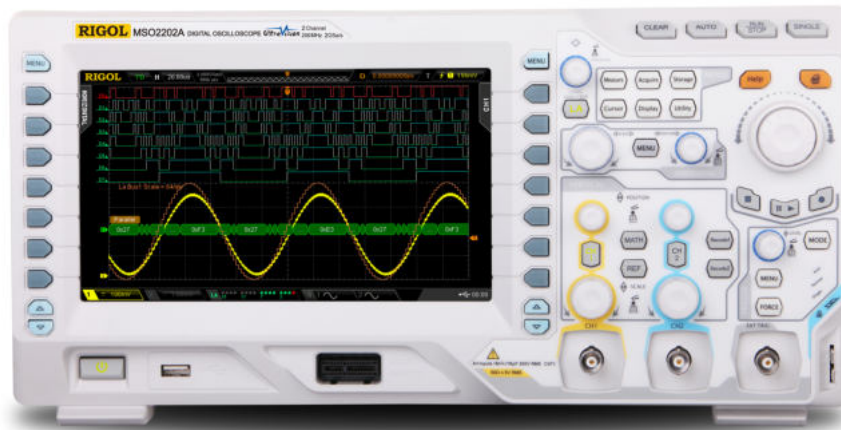

MSO/DS2000A series provides bandwidth from 100 MHz to 300 MHz, sample rate up to 2 GSa/s, and 2+16 channels. It is easy to operate. With a variety of functions, the user-friendly UI design, and the 256-level intensity grading display that allows you to see the signal anomalies clearly, it is a helpful tool in addressing the challenge in application scenarios such as circuit design, embedded debugging and power supply design.

- Bandwidth: 100MHz - 300 MHz
- 2 analog channels, 16 digital channels available only for the MSO model
- Waveform capture rate up to 52,000 wfms/s
- High dynamic range, low noise floor, and min. range 500 μ V/div
- Built-in dual -channel 25 MHz signal generator (for the -S model)
- A variety of triggers and bus decodes

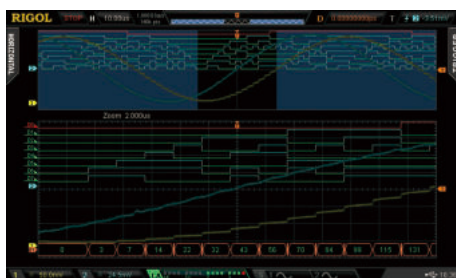

Mixed signal analysis with analog and digital channels



Serial bus triggers and decodes

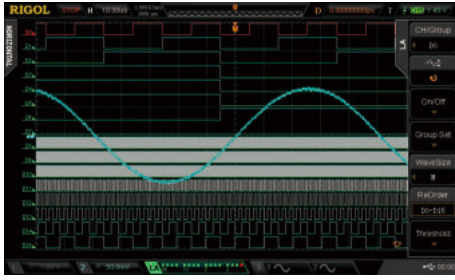

Digital channel grouping and flexible label setting

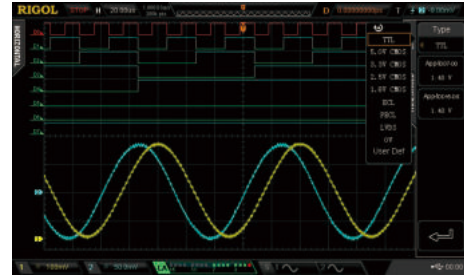

Digital channel provides multiple logic level options



256-level intensity grading waveform display



Real-time and ceaseless waveform recording, playback, and analysis function

Models and Specifications

Model	DS2302A	MSO2302A-S	DS2202A	MSO2202A-S	DS2102A	MSO2102A-S
	MSO2302A		MSO2202A		MSO2102A	
Analog Bandwidth	300 MHz		200 MHz		100 MHz	
No. of Input Channels	2+16 (Only for MSO models)					
Max. Sample Rate of Analog Channel	Analog channel: 2 GSa/s (single-channel), 1 GSa/s on each channel; Digital channel: 1 GSa/s (8CH), 500 MSa/s (16CH)					
Standard Memory Depth	Analog channel: 7 Mpts (dual-channel), 14 Mpts (single-channel) Digital channel: 7 Mpts (16CH), 14 Mpts (8CH)					
Optional Memory Depth	Analog channel: 28 Mpts (dual-channel), 56 Mpts (single-channel) Digital channel: 14 Mpts (16CH), 28 Mpts (8CH)					
Max. Waveform Capture Rate	50,000 wfms/s					
Range of Time Base	1 ns/div to 1,000 s/div		2 ns/div to 1,000 s/div		5 ns/div to 1,000 s/div	
Vertical Sensitivity Range	Analog channel: 500 μ V/div to 10 V/div (1 M Ω); or 500 μ V/div to 1 V/div (50 Ω)					
	Digital channel: Threshold adjustable for each group of 8 channels, threshold range \pm 20 V, in 10 mV step					

Model	DS2302A	MSO2302A-S	DS2202A	MSO2202A-S	DS2102A	MSO2102A-S
	MSO2302A		MSO2202A		MSO2102A	
DC Gain Accuracy ^[1]	± 2% of full scale					
Hardware Real-time Waveform Recording and Playing	Max. 65,000 frames					
Trigger Type	Standard: Edge, Pulse, Runt, Slope, Pattern, Setup/Hold, RS232/UART, I2C, SPI Option: Window, Nth Edge, Delay, Video, Timeout, Duration, CAN, USB Trigger					
Bus Decoding	Standard: Parallel (Only for MSO models), RS232/UART, I2C, SPI, and CAN					
Auto Measurement	Analog channel: 29 measurement items; digital channel: 12 measurement items					
Waveform Calculation	A+B, A-B, A×B, A/B, FFT, digital filter, advanced math, and logic operation					
I/O	USB Host, USB Device, LAN (LXI), AUX, support USB-GPIB (opt.)					
LCD Size and Type	8.0" WVGA (800X480) LCD display, 256-level intensity grading display					
Weight ^[2]	Package excluded: 3.9 kg ± 0.5 kg Package included: 4.5 kg ± 0.5 kg					

NOTE:

[1]: 500 μ V/div is a magnification of 1 mV/div setting. For the calculation of the DC gain accuracy, use the full scale of 8 mV for 500 μ V/div (calculated based on 1 mV/div).

[2]: Standard configuration.

Order Information

Order Information	Order No.
Model	
DS2012A (100 MHz, 2CH Digital Oscilloscope)	DS2012A
MSO2012A (100 MHz, 2+16 CH MSO)	MSO2012A
MSO2012A-S (100 MHz, 2+16 CH MSO + Dual-Channel Signal Generator)	MSO2012A-S
DS2022A (200 MHz, 2CH DS)	DS2022A
MSO2022A (200 MHz, 2+16 CH MSO)	MSO2022A
MSO2022A-S (200 MHz, 2+16 CH MSO + Dual-Channel Signal Generator)	MSO2022A-S
DS2302A (300 MHz, 2CH DS)	DS2302A
MSO2302A (300 MHz, 2+16 CH MSO)	MSO2302A
MSO2302A-S (300 MHz, 2+16 CH MSO + Dual-Channel Signal Generator)	MSO2302A-S
Standard Accessories	
Power Cord Conforming to the Standard of the Destination Country	-
USB Cable	CB-USBA-USBB-FF-150
Passive Probe x2 (1X: 35MHz/10X: 350 MHz)	PVP2350

Order Information	Order No.
Logic Probe x1 (Only Available for the MSO Model)	RPL2316

NOTE:

For all the accessories and options, please contact the local office of RIGOL.

MSO/DS1000Z/Z-E Series Digital Oscilloscope



DS1000Z series is the high performance, economic level general purpose oscilloscope which provides 4 analog channels, 4 bandwidth models (50 MHz, 70 MHz, 100 MHz, and 200 MHz), and up to 1GSa/s sample rate. With the UltraVision technical platform, the DS1000Z series has sustained its deep memory and high capture rate, exhibiting its cost-effective advantages.

- Bandwidth: 50 MHz, 70 MHz, 100 MHz, and 200 MHz
- 4 analog channels, 16 digital channels available only for the Plus model
- 2 analog channels (DS1000Z-E series)
- Up to 24 Mpts memory depth (std.)
- A variety of triggers and bus decodes
- Built-in dual -channel 25 MHz signal generator (for the -S model)
- Various interfaces: USB, LAN (LXI), and GPIB (opt.)



4 analog channels and 16 digital channels (supported only when the DS1000Z Plus is upgraded with the MSO upgrade option)



UltraVision: high memory depth (up to 24 Mpts/CH std.)



UltraVision: waveform capture rate up to 30,000 wfms/s

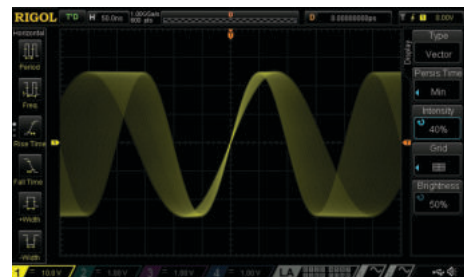

UltraVision: multi-level intensity grading display

Models and Specifications

Model	DS1054Z	DS1074Z Plus	DS1074Z-S Plus	DS1104Z Plus	DS1104Z-S Plus	DS1102Z-E (dedicated for e-commerce sale)	DS1202Z-E (dedicated for e-commerce sale)
Analog Bandwidth	50 MHz	70 MHz		100 MHz		200 MHz	
Input Channels	Analog	4				2	
	Digital	N/A	16 digital channels supported for the DS1000Z Plus that has been installed with the MSO upgrade option			N/A	
Range of Time Base	2 ns/div to 1 ks/div					2 ns/div to 50 s/div	
	Fine						
Max. Sample Rate of Analog Channel	Analog channel: 1 GSa/s (1CH), 500 MSa/s (2CH), 250 MSa/s (3/4CH) Digital channel: 1 GSa/s (8CH), 500 MSa/s (16CH)					Analog channel: 1 GSa/s (1CH), 500 MSa/s (2CH)	
Standard Memory Depth	Analog channel: 24 Mpts (1CH), 12 Mpts (2CH), 6 Mpts (3/4CH) Digital channel: 24 Mpts (8CH), 12 Mpts (16CH)					Analog channel: 24 Mpts (1CH), 12 Mpts (2CH) std.	
Max. Waveform Capture Rate	30,000 wfms/s						
Vertical Sensitivity Range ^[1]	1.0 div (below 5 mV or with noise rejection enabled) 0.3 div (above 5 mV and with noise rejection disabled)						

Model	DS1054Z	DS1074Z Plus	DS1074Z-S Plus	DS1104Z Plus	DS1104Z-S Plus	DS1102Z-E (dedicated for e-commerce sale)	DS1202Z-E (dedicated for e-commerce sale)
DC Gain Accuracy	$<10 \text{ mV}: \pm 4\%$ of full scale $\geq 10 \text{ mV}: \pm 3\%$ of full scale						
Hardware Real-time Waveform Recording and Playing	Max. 60,000 frames						
Trigger Type	Edge trigger, Pulse trigger, Slope trigger, Video trigger, Pattern trigger, Duration trigger, Timeout trigger, Runt trigger, Window trigger, Delay trigger, Setup/Hold trigger, Nth Edge trigger, I2C, SPI, and RS232/UART						
Waveform Measurement	Displays 5 measurements at the same time						
Waveform Calculation	A+B, A-B, AxB, A/B, FFT, A&&B, A B, A^B, !A, Intg, Diff, Lg, Ln, Exp, Sqrt, Abs, and Filter						
I/O	USB Host, USB Device, LAN, Aux Output (TrigOut/PassFail)						
LCD Size and Type	7.0" TFT LCD						
Size	313.1 mm (W) x 160.8 mm (H) x 122.4 mm (D)						
Weight ^[2]	Package excluded: 3.2 kg \pm 0.2 kg						
	Package included: 3.8 kg \pm 0.5 kg						

NOTE:

[1]: Typical.

[2]: Standard configuration.

Order Information

Order Information	Order No.
Model	
DS1202Z-E (200 MHz, 2CH)	DS1202Z-E
DS1102Z-E (100 MHz, 2CH)	DS1102Z-E
DS1074Z Plus (100 MHz, 4CH, upgradable to 16 digital channels)	DS1074Z-S Plus
DS1104Z-S Plus (100 MHz, 4CH, 2CH 25 MHz signal source, upgradable to 16 digital channels)	DS1104Z-S Plus
DS1074Z Plus (70 MHz, 4CH, upgradable to 16 digital channels)	DS1074Z Plus
DS1074Z-S Plus (70 MHz, 4CH, 2CH 25 MHz signal source, upgradable to 16 digital channels)	DS1074Z-S Plus
DS1054Z (50 MHz, 4CH)	DS1054Z
Standard Accessories	
Power Cord Conforming to the Standard of the Destination Country	-
USB Cable x1	CB-USBA-USBB-FF-150
Passive Probes x4 (150 MHz)	PVP3150

Order Information	Order No.
MSO Upgrade Option	
Only available for DS1000Z Plus, including the logic analyzer probe (RPL1116)	MSO1000Z Upgrade Package
Options and Accessories	
Rack Mount Kit	RM-DS1000Z

NOTE:

For all the accessories and options, please contact the local office of RIGOL.

Bus Analysis Guide

Serial buses like I2C, SPI, UART/RS232, and USB are widely used in electronic, telecom products as well as other embedded devices. RIGOL's mainstream oscilloscopes provide commonly used bus analysis functions. The oscilloscope can trigger based on the user-defined conditions, such as triggering at the start frame, end frame, specific address and/or data, or error frame.

Also, the oscilloscope can do bus decoding, which can convert the complicated waveforms to various data or symbols, helping engineers to better understand the command execution and data transmission. The waveform table generated can also display the data frames in the form of tables. With the deep memory depth of the oscilloscopes of RIGOL, users can analyze the time sequence between system command and the peripheral signals clearly and completely.

Model	Decode Buses	CH	I2C	SPI	RS232 /UART	CAN	LIN	FlexRay	I2S	MIL-STD-1553
			Trigger	Decode	Trigger	Decode	Trigger	Decode	Trigger	Decode
DHO4000 Series	4	Analog								
DHO4000-AUTOA						○	○	○	○	
DHO4000-AEROA										○ ○
DHO4000-FLEXA								○ ○		
DHO4000-AUDIOA									○ ○	
DS70000 Series	4	Analog								
DS70000-EMBDA			○ ○	○ ○	○ ○					
DS70000-AUTOA						○ ○	○ ○	○ ○		
DS70000-AUDIOA									○ ○	
DS70000-AEROA										○ ○
DS8000-R	4	Analog								
DS8000-R-COMP					○ ○					
DS8000-R-EMBD			○ ○	○ ○						
DS8000-R-AUTO						○ ○	○ ○			
DS8000-R-FLEX								○ ○		
DS8000-R-AUDIO									○ ○	
DS8000-R-AERO										○ ○
MSO8000/A Series	4	Analog & Digital								
MSO8000-COMP					○ ○					
MSO8000-EMBD			○ ○	○ ○						
MSO8000-AUTO						○ ○	○ ○			
MSO8000-FLEX								○ ○		
MSO8000-AUDIO									○ ○	
MSO8000-AERO										○ ○

Model	Decode Buses	CH	I2C		SPI		RS232 /UART		CAN		LIN		FlexRay		I2S		MIL-STD-1553	
			Trigger	Decode	Trigger	Decode	Trigger	Decode	Trigger	Decode	Trigger	Decode	Trigger	Decode	Trigger	Decode	Trigger	Decode
MSO/DS7000 Series	4	Analog & Digital																
DS7000-COMP							○	○										
DS7000-EMBD			○	○	○	○												
DS7000-AUTO									○	○	○	○						
DS7000-FLEX													○	○				
DS7000-AUDIO															○	○		
DS7000-AERO																	○	○
MSO5000 Series	4	Analog & Digital																
MSO5000-COMP							○	○										
MSO5000-EMBD			○	○	○	○												
MSO5000-AUTO									○	○	○	○						
MSO5000-FLEX													○	○				
MSO5000-AUDIO															○	○		
MSO5000-AERO																	○	○
MSO/DS2000A Series	2	Analog & Digital	●		●		●											
SD-DS2000				●		●		●										
CAN-DS2000A									●	●								
BND-MSO/DS2000A				●		●		●	●	●								
DS1000Z/-E Series	2	Analog	●	●	●	●	●	●										
DS1000Z Series	2	Analog & Digital	●	●	●	●	●	●										

NOTE:

- Option.
- Standard.

Power Test and Analysis

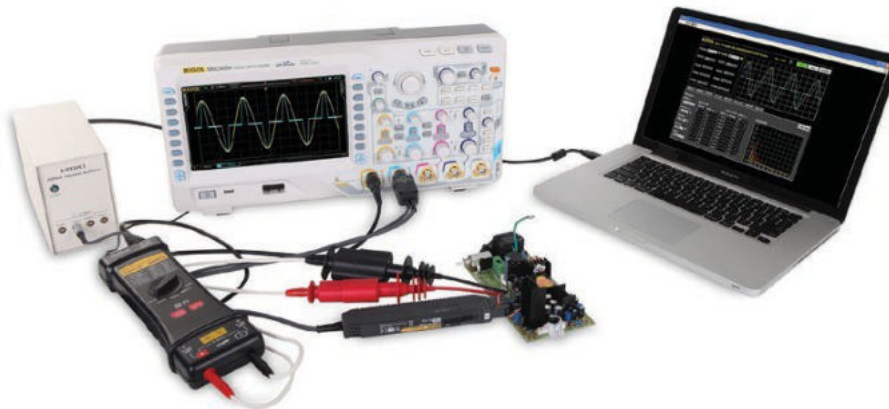

Power supply is an important component of electronic devices. The development, design, and debugging of the power supply circuit are important part for the product development and production. In the power testing, various test devices may be used, in particular, the oscilloscope and the probe are most commonly used. Users can select a proper high-voltage probe or the current probe to make measurements based on the different signals under test. With the software, users can obtain the power-related measurement results.

Ultra Power Analyzer launched by RIGOL is a PC software with full-function power measurement and analysis. The software along with RIGOL's digital oscilloscope, high voltage differential probe, current probe, probe deskew fixture, and passive probe, forms a complete power measurement system for power supply design and testing. After testing, the test results will be delivered in the form of a test report.

- Power quality analysis
- Current harmonic analysis
- Inrush current analysis
- Power device switching loss analysis
- Safe operating area analysis
- Modulation analysis
- Output ripple analysis



Power quality analysis



Safe operating area analysis



Power device switching loss analysis



Power quality analysis

DHO4000, DS70000, DS8000-R, MSO8000/A, MSO/DS7000, and MSO5000 series oscilloscopes support the optional built-in power analysis software, which can complete the power quality analysis and ripple analysis. The power analysis software can help engineers analyze the commonly used power parameters rapidly and accurately, without needing to make tedious configurations manually or do complicated calculation.

Recommended Configuration

	Description	Order No.
Digital Oscilloscope Model	DHO4000, DS70000, DS8000-R, MSO8000/A, MSO/DS7000, MSO5000, MSO/DS2000A, MSO/DS1000Z and DS1000Z-E Series	
Accessories	High-Voltage Differential Probe (Depend on the Selected Bandwidth and Voltage Range)	RP1000D
	Current Probe (Depend on the Selected Bandwidth and Current Range)	RP1000C
	1:1 Passive HighZ Probe (Depend on the Selected Bandwidth)	PVP3150/PVP2350
Power Analysis Software	Ultra Power Analyzer	UPA-DS
	Built-in Power Analysis (Only Available for DHO4000)	DHO4000-PWR
	Built-in Power Analysis (Only Available for MSO8000/A)	MSO8000-PWR
	Built-in Power Analysis (Only Available for MSO/DS7000)	DS7000-PWR
	Built-in Power Analysis (Only Available for MSO5000)	MSO5000-PWR
	Built-in Power Analysis (Only Available for DS8000-R; Required to Purchase the RPA246 Phase Deviation Correction Jig)	DS8000-R-PWR

Probes and Accessories Selection Guide

High-Speed Active Differential Probe



PVA8000



PVA7250



RP7150/RP7080

Current Probe



RP1000P



RP1001C/RP1002C



PCA2030



PCA1150

High-Speed Active Single-ended Probe

High-voltage Probe



RP7150S/RP7080S



RP1018H

High-voltage Differential Probe



PHA0150/PHA1150/PHA2150



RP1000D

Options Guide

Model	Description	DHO4000	DHO1000	DS7000	DS8000-R	MSO8000A	MSO/DS7000	MSO5000	MSO/DS2000A	DS1000Z-E	DS1000E/U
PVA8700	7 GHz Active Differential Probe, 30 V _{p-p} , CATI			○							
PVA8350	3.5 GHz Active Differential Probe, 30 V _{p-p} , CATI			○							
PVA7250	2.5 GHz Active Differential Probe, 30 V _{p-p} , CATI			○	○	○	○				
RP7150	1.5 GHz Active Differential/Single-ended Probe, 30 V _{p-p} , CATI			○	○	○	○				
RP7150S	1.5 GHz Active Single-ended Probe, 30 V _{p-p} , CATI			○	○	○	○				
RP7080	800 MHz Active Differential/Single-ended Probe, 30 V _{p-p} , CATI			○	○	○	○				
RP7080S	800 MHz Active Single-ended Probe, 30 V _{p-p} , CATI			○	○	○	○				
RP6150A	1.5 GHz Passive Low-impedance Probe				○	● ^[1]	○	○			
RP5600A	600 MHz HighZ Probe, 10X			○	○	○	○	○			
RP3500A	500 MHz HighZ Probe, 10X	●		●		●	●	○	○	○	○
PVP2350	1X: 35 MHz BW/10X: 350 MHz BW, Passive HighZ Probe	●	●	○	○	○	○	●	●	● ^[2]	○

Model	Description	DHO4000	DHO1000	DS7000	DS8000-R	MSO8000A	MSO/DST7000	MSO5000	MSO/DS2000A	DS1000Z/E	DS1000E/U
PVP3150	1X: 20 MHz BW/10X: 150 MHz BW, Passive HighZ Probe		•	○	○	○	○	○	○	•	•
RP1300H	High-voltage Probe DC-300 MHz, 2000 V CATI, 1500 V CATII (DC+AC)			○	○	○	○	○	○	○	○
RP1010H	High-voltage Probe DC-50 MHz, DC: 10 KV, AC: pulse ≤ 20 KV _{pp} , sine ≤ 7 KV _{rms}			○	○	○	○	○	○	○	○
RP1018H	High Voltage Probe, DC-150 MHz, DC+AC: 18 KVp CATII, AC:12 KV _{rms} CATII			○	○	○	○	○	○	○	○
RP1025D	High-Voltage Differential Probe DC-25 MHz, V _{max} ≤ 1400 Vpp			○	○	○	○	○	○	○	○
RP1050D	High-Voltage Differential Probe DC-50 MHz, V _{max} ≤ 7000 Vpp			○	○	○	○	○	○	○	○
RP1100D	High-Voltage Differential Probe DC-100 MHz, V _{max} ≤ 7000 Vpp			○	○	○	○	○	○	○	○
PHA0150	High-Voltage Differential Probe DC-100 MHz, V _{max} ≤ 1500 Vpp			○	○	○	○	○	○	○	○
PHA1150	High-Voltage Differential Probe DC-100 MHz, V _{max} ≤ 1500 Vpp			○	○	○	○	○	○	○	○
RP1001C	Current Probe DC-300 KHz, DC: ± 100 A, AC: 200 A _{pp} , 70 A _{rms}			○	○	○	○	○	○	○	○
RP1002C	Current Probe DC-1 MHz, DC: ± 70 A, AC: 140 A _{pp} , 50 A _{rms}			○	○	○	○	○	○	○	○
RP1003C	Current Probe DC-50 MHz, Max. Current: 50 A (non-continuous), 30 A _{rms} , Required to Order RP1000P Power Supply			○	○	○	○	○	○	○	○
RP1004C	Current Probe DC-100 MHz, Max. Current: 50 A (Non-continuous), 30 A _{rms} , Required to Order RP1000P Power Supply			○	○	○	○	○	○	○	○
RP1005C	Current Probe DC-100 MHz, Max. Current: 300 A (Non-continuous), 500 A _{peak} , 150 A _{rms} , Required to Order RP1000P Power Supply			○	○	○	○	○	○	○	○
RP1006C	Current Probe DC-2 MHz, Max. Current: 700 A (Non-continuous), 500 A _{rms} , Required to Order RP1000P Power Supply			○	○	○	○	○	○	○	○
RP1000P	Available for RP1003C/1004C/1005C/1006C Power Supply			○	○	○	○	○	○	○	○
PCA1030	Current Probe DC-50 MHz, Max. Current: 50 A (non-continuous), 30 A _{rms} , Power Supplied by the Digital Oscilloscope			○	○	○	○				
PCA2030	Current Probe DC-100 MHz, Max. Current: 50 A (Non-continuous), 30 A _{rms} , Power Supplied by the Digital Oscilloscope			○	○	○	○				
PCA1150	Current Probe DC-10 MHz, Max. Current: 300 A (Non-continuous), 500 A _{peak} , 150 A _{rms} , Power Supplied by the Digital Oscilloscope			○	○	○	○				
RPL2316	16-Channel Logic Analyzer Probe for MSO7000/8000 Series					○	○		○		
PLA2216	16-Channel Logic Analyzer Probe for MSO5000 Series							○			

Model	Description	DHO4000	DHO1000	DS7000	DS8000-R	MSO8000A	MSO/DST7000	MSO5000	MSO/DS2000A	DS1000Z/E	DS1000E/U
RPL1116	16-Channel Logic Analyzer Probe for MSO1000Z Series									○	
T2R1000	Tek Probe to RIGOL Oscilloscope Adaptor				○	○	○				
USB-GPIB	USB-GPIB Adaptor			○	○	○	○	○	○	○	○
ADP0150BNC	50 ohm Adaptor (2W, 1 GHz)							○		○	○

NOTE:

- Standard ○ Option

[1] Only available for MSO8204/MSO8104/MSO8204A/MSO8154A

[2] Only available for DS1202Z-E

Function/Arbitrary Waveform Generator



RIGOL's function/arbitrary waveform generator adopts the latest Direct Digital Frequency Synthesis technology (DDS) to generate accurate and stable standard function waveforms such as Sine, Square, Triangle, and Pulse, as well as the analog/digital modulated signals. What's more, the generator also provides arbitrary waveform function which allows engineers to generate any desired waveforms either using the UltraWave arbitrary waveform editing software or using the UltraStation editing software to work with the instrument to capture the actual signal and generate the arbitrary waveforms. The digital sampling technology and the Direct Digital Frequency Synthesis technology enable engineers to generate any desired waveform for circuit verification design.

RIGOL has launched a series of function/arbitrary waveform generators over the past years, including DG70000, DG5000, DG4000, DG2000, DG1000, DG1000Z, DG900, and DG800 series with up to 5 GHz output frequency, 12 GSa/s sample rate, 1.5 Gpts memory depth, and 16 bits vertical resolution. The LCD display, user-friendly UI design, and panel layout have brought users with extraordinary experience. The multiple interfaces realizes flexible connectivity, allowing users to remotely control the instrument and enabling generators to be the excellent circuit debug tools for engineers.

Model	Max. Output Frequency (MHz)	No. of Channels	Max. Sample Rate	Memory Depth	Waveform Generation Technology	Modulation Types
DG70000	5000	4	10 GSa/s (real) 12 Gsa/s (complex)	1.5 Gpts	SiFi III	IQ Modulation (Opt.)
DG5000	70/100/250/350	1/2	1 GSa/s	128 Mpts	DDS	AM, FM, PM, ASK, FSK, PSK, PWM, and IQ

Model	Max. Output Frequency (MHz)	No. of Channels	Max. Sample Rate	Memory Depth	Waveform Generation Technology	Modulation Types
DG4000	60/100/160/200	2	500 MSa/s	16 kpts	DDS	AM, FM, PM, ASK, FSK, PSK, BPSK, QPSK, 3FSK, 4FSK, OSK, and PWM
DG2000	50/70/100	2	250 MSa/s	16 Mpts	SiFi II	AM, FM, PM, ASK, FSK, PSK, and PWM
DG1000Z	25/30/60	2	200 MSa/s	8 Mpts/2 Mpts (DG1022Z) (16 Mpts, opt.)	SiFi	AM, FM, PM, ASK, FSK, PSK, and PWM
DG1000	25	2	100 MSa/s	4 Kpts	DDS	AM, FM, PM, and FSK
DG900	50/70/100	2	250 MSa/s	16 Mpts	SiFi II	AM, FM, PM, ASK, FSK, PSK, and PWM
DG800	10/25/35	1/2	125 MSa/s	2 Mpts (8 Mpts, opt.)	SiFi II	AM, FM, PM, ASK, FSK, PSK, and PWM

DG70000 Series Arbitrary Waveform Generator



Built on its unique SiFi III technical platform and Android operating system, the DG70000 series Arbitrary Waveform Generator (AWG) has the following advantages: accurate and adjustable sample rates; generate arbitrary waveforms point by point; recover the signal without distortion; etc. This series is customer-oriented with a variety of functions suitable for practical applications. For example, the creation of advanced sequences enables you to self-define long complex waveforms. The multi-channel high-precision synchronization, high-bandwidth and low-jitter waveform output make it ready for applications in a variety of industrial and communications fields. Equipped with a 15.6-inch angle-adjustable touch screen supporting multi-pane windowing, it brings a brand new UI design and extraordinary user experience. Multiple standard interfaces provide you with more solutions in connectivity, making it simple to control the instrument remotely.

- Up to 5 GSa/s sample rate (interpolated: 12 GSa/s)
- -70 dBc SFDR
- 16-bit vertical resolution, 1.5 Gpts memory depth per channel
- Generate the arbitrary waveforms point by point; recover the signal without distortion
- Total jitter low as 10 psp-p, random jitter low as 350 fsrms
- Sample rate adjustable, ranging from 100 Sa/s to 12 GSa/s
- High-precision synchronization, with the channel-to-channel skew repeatability ± 10 ps
- Support creating advanced sequence to define outputs of various types of complex waveforms; support importing external waveform files



16-bit vertical resolution

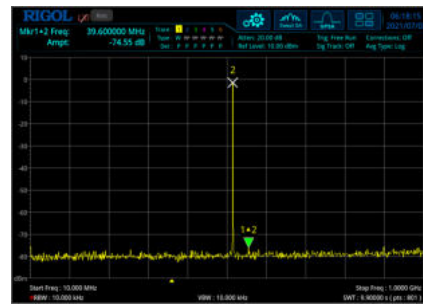

-70 dBc SFDR



Multi-channel synchronization output



1.5 GHz modulation bandwidth

Models and Specifications

Model	DG70004	DG70002
No. of Channels	4	2
Max. Output Frequency	2 GHz (for real mode); 4 GHz (for complex mode, 10 GSa/s)	
Sample Rate	100 Sa/s to 12 GSa/s ^[1]	
Vertical Resolution	16 bits (0 Marker/channel) 15 bits (1 Marker/channel) 14 bits (2 Markers/channel)	
Memory Depth	1.5 Gpts/channel	
Rise/Fall Time	<120 ps @ 700 mVpp single-ended voltage swing (DC HBW); <160 ps @ 1.0 Vpp single-ended voltage swing (DC AMP)	
Jitter	Random Jitter: 350 fs _{rms} ; Total Jitter: 10 ps _{p-p}	
Jump	Wait, sync jump, async jump, Go To, and pattern jump	
Sequence Generator	Supported waveform length: 2.4 kpts to 500 Mpts (1.5 Gpts opt.) Minimum waveform granularity: 1 pts	

NOTE:

[1]: 5 GSa/s (interpolated: 10 GSa/s for real output; 12 GSa/s for complex output).

Order Information

	Description	Order No.
Model	DG70004 (4CH, 2 GH BW, 5 GSa/s sample rate, 1.5 Gpts memory depth)	DG70004
	DG70002 (2CH, 2 GH BW, 5 GSa/s sample rate, 1.5 Gpts memory depth)	DG70002
Standard Accessories	Power Cord Conforming to the Standard of the Destination Country	-
	USB Cable x1	-
	Three 50 Ω , 18 GHz SMA terminators per channel (12 in total)	-
Function Upgrade Option	Digital Up Converter (DUC) and IQ Modulation	DG70000-DIGUP
	Complex Sequence Function	DG70000-SEQ
	High-Speed Serial Waveform Function	DG70000-PJ
	DC Amplifier Output	DG70000-DC
	Multitone & Chirp Mode	DG70000-MTONENL

DG5000 Series Function/ Arbitrary Waveform Generator



DG5000 series is a multi-functional generator that integrates many functions into one, including Arbitrary Waveform Generator, Pulse Generator, IQ Baseband Source/IQ IF Source, Frequency Hopping Source Pattern Generator, and Function Generator. The DG5000 series, adopting the Direct Digital Synthesizer (DDS) technology, can provide stable, precise, pure and low distortion signals. The user-friendly interface design and panel layout bring users extraordinary experience. Besides, the standard configuration of interfaces allow users to remotely control the instrument, providing more solutions for users. It provides single and dual-channel models. The two channels have identical functions and phase adjustable between the two channels.

- 1GSa/s sample rate, 128 M waveform length
- Support internal and external IQ modulation
- Analog/digital modulation
- Various sweep types (std.)
- Intuitive constellation setup and display
- Support frequency hopping function (opt.)
- Various interfaces for connectivity, support digital and logic outputs

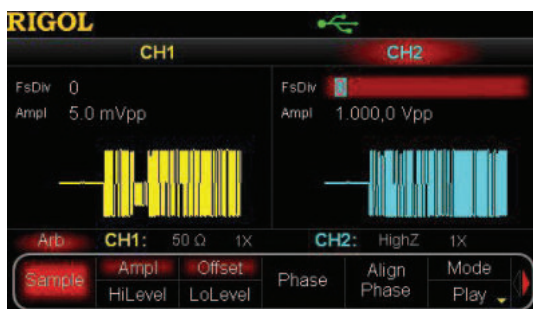

1 GSa/s sample rate, 14 bits resolution

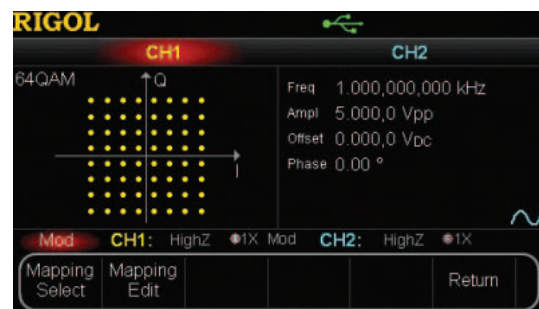

Intuitive constellation setup and display



Various sweep types (std.)

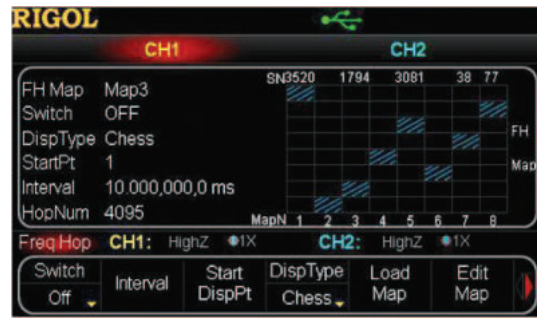

Support frequency hopping function (opt.)

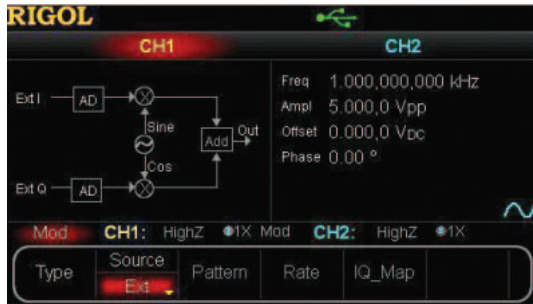

Support internal and external IQ modulation (std.)



Various interfaces for connectivity, support parallel bus output

Models and Specifications

Model	DG5351/2	DG5251/2	DG5101/2	DG5071/2
No. of Channels	1/2	1/2	1/2	1/2
Max. Output Frequency	350 MHz	250 MHz	100 MHz	70 MHz
Sample Rate	1 GSa/s			
Waveform Type	Standard Waveforms: Sine, Square, Ramp, Pulse, Noise Arbitrary Waveforms: Sinc, Exponential Rise, Exponential Fall, ECG, Gauss, HaverSine, Lorentz, Dual-Tone, DC, and user-defined			
Sine	1 μ Hz to 350 MHz	1 μ Hz to 250 MHz	1 μ Hz to 100 MHz	1 μ Hz to 70 MHz
Square	1 μ Hz to 120 MHz	1 μ Hz to 120 MHz	1 μ Hz to 100 MHz	1 μ Hz to 70 MHz
Ramp	1 μ Hz to 5 MHz	1 μ Hz to 5 MHz	1 μ Hz to 3 MHz	1 μ Hz to 3 MHz
Pulse	1 μ Hz to 50 MHz			
Noise	250 MHz			
Arbitrary Waveform	1 μ Hz to 50 MHz			
Waveform Length	128 M (std.)			
Sine Wave Spectrum Purity	Total Harmonic Distortion <0.5% (10 Hz-20 KHz, 0 dBm) Phase Noise <-110 dBc@10 MHz (0 dBm, 10 KHz offset)			
Square Rise/Fall Time	<2.5 ns	<2.5 ns	<3 ns	<4 ns

Model	DG5351/2	DG5251/2	DG5101/2	DG5071/2
Jitter	$\leq 30\text{MHz}$: 10 ppm + 500 ps $> 30\text{MHz}$: 500 ps			
Amplitude (into 50 Ω)	$\leq 100\text{MHz}$: 5 mVpp to 10 Vpp $\leq 300\text{MHz}$: 5 mVpp to 5 Vpp $\leq 350\text{MHz}$: 5 mV to 2 Vpp			
IQ Modulation	4QAM, 8QAM, 16QAM, 32QAM, 64QAM, BPSK, QPSK, OQPSK, 8PSK, 16PSK, and user-defined Symbol Rate: 1 bps to 1 Mbps Carrier Waveform: Sine Frequency: $\leq 200\text{ MHz}$			
Frequency Hopping	FH Bandwidth 1.5 MHz to 250 MHz (or max. frequency of the instrument); FH Rate: 1 Hop/s to 12.5M Hop/s; Number of Frequency Points: 4096			
Burst Characteristics	Carrier frequency: 1 μHz to 120 MHz (or max. frequency of the instrument) Burst count: 1 to 1 million, or Infinite			

Order Information

	Description	Order No.
Model	DG5352 (AWG, 350 MHz, dual-channel, 128 Mpts)	DG5352
	DG5351 (AWG, 350 MHz, single-channel, 128 Mpts)	DG5351
	DG5252 (AWG, 250 MHz, dual-channel, 128 Mpts)	DG5252
	DG5251 (AWG, 250 MHz, single-channel, 128 Mpts)	DG5251
	DG5102 (AWG, 100 MHz, dual-channel, 128 Mpts)	DG5102
	DG5101 (AWG, 100 MHz, single-channel, 128 Mpts)	DG5101
	DG5072 (AWG, 70 MHz, dual-channel, 128 Mpts)	DG5072
	DG5071 (AWG, 70 MHz, single-channel, 128 Mpts)	DG5071
Standard Accessories	USB Cable x1	CB-USBA-USBB-FF-150
	BNC Cable x1 (1 meter)	CB-BNC-BNC-MM-100
	SMB(F)-to-BNC(M) Cable (1 meter)	CB-SMB-BNC-FM-100
	Power Cord Conforming to the Standard of the Destination Country	-
Options	Frequency Hopping Module	FH-DG5000
	Arbitrary Waveform Editing PC Software (advanced function)	UltraStation-adv
	Power Amplifier	PA1101
	40 dB Attenuator	RA5040K
	Rack Mount Kit	RM-DG5000

DG4000 Series Function/ Arbitrary Waveform Generator

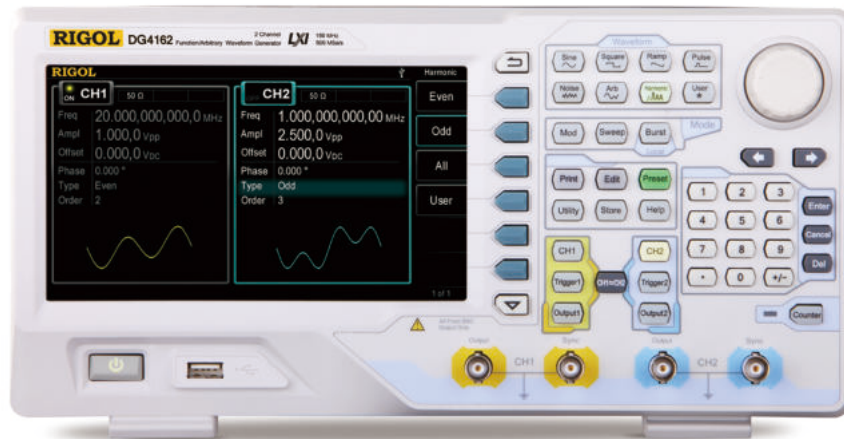

DG4000 series is a multi-functional generator that integrates many functions into one, including Function Generator, Arbitrary Waveform Generator, Pulse Generator, Harmonic Generator, Analog/Digital Modulator and Frequency Counter. With the Direct Digital Synthesizer (DDS) technology, the DG4000 series provides stable, precise, pure and low distortion signals. The max. frequency can reach up to 200 MHz. The high-definition wide screen display, friendly interface design and key operation layout bring users with extraordinary experience. The standard LAN and USB interfaces allow users to remotely control the instrument, providing more solutions for users. All models of this series have two channels with identical functions and phase adjustable between channels.

- 7" LCD display
- 150 built-in arbitrary waveforms
- Abundant analog and digital modulation functions
- Various sweep modes
- Noise and burst modes
- Generate up to 16th order of harmonics

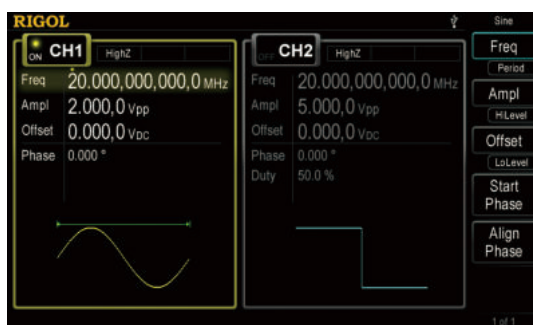

Dual channels with identical functions and phase adjustable between channels

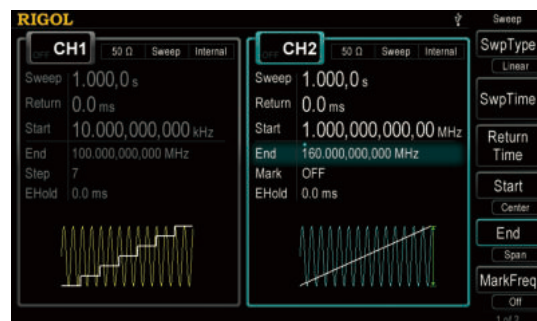

Various sweep modes

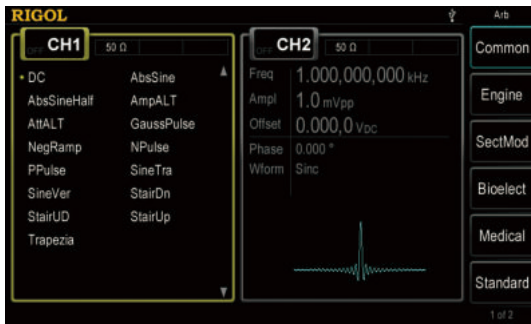

Arbitrary waveform editing (std.) and 150 built-in arbitrary waveforms

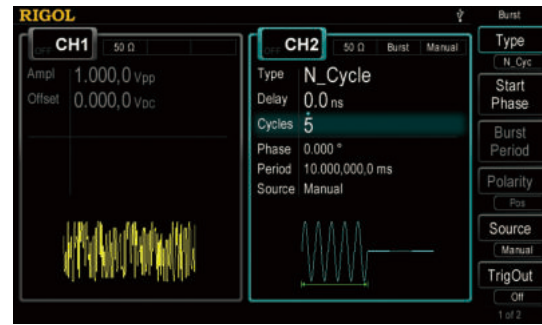

Noise and burst modes

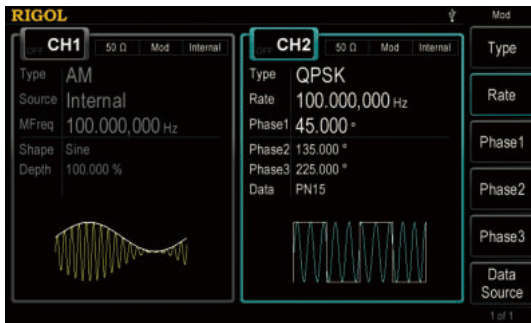

Abundant analog and digital modulation functions

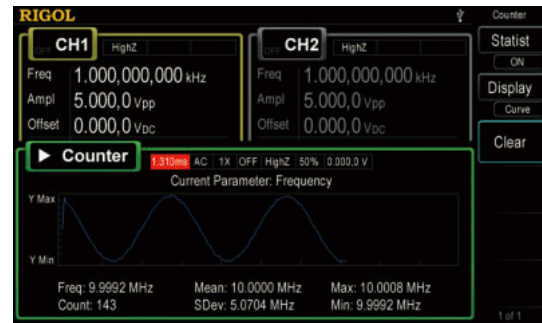

7-digit frequency counter with statistical analysis

Models and Specifications

Model	DG4202	DG4162	DG4102	DG4062
No. of Channels	2			
Max. Output Frequency	200 MHz	160 MHz	100 MHz	60 MHz
Sample Rate	500 MSa/s			
Waveform Type	Standard Waveforms: Sine, Square, Ramp, Pulse, Noise, Harmonics (up to 16 orders) Arbitrary Waveforms: 150 waveforms including Sinc, Exponential Rise, Exponential Fall, ECG, Gauss, HaverSine, Lorentz, Dual-Tone, and DC			
Waveform Length	16 K			
Vertical Resolution	14 bits			
Sine	1 μ Hz to 200 MHz	1 μ Hz to 160 MHz	1 μ Hz to 100 MHz	1 μ Hz to 60 MHz
Square	1 μ Hz to 60 MHz	1 μ Hz to 50 MHz	1 μ Hz to 40 MHz	1 μ Hz to 25 MHz
Ramp	1 μ Hz to 5 MHz	1 μ Hz to 4 MHz	1 μ Hz to 20 MHz	1 μ Hz to 1 MHz
Pulse	1 μ Hz to 50 MHz	1 μ Hz to 40 MHz	1 μ Hz to 25 MHz	1 μ Hz to 15 MHz
Noise (-3 dB)	120 MHz	120 MHz	80 MHz	60 MHz

Model	DG4202	DG4162	DG4102	DG4062
Sine Wave Spectrum Purity	Total Harmonic Distortion <0.1% (10 Hz-20 KHz, 0 dBm) Phase Noise: ≤ -115 dBc@10 MHz (0 dBm, 10 KHz offset)			
Square Rise/Fall Time	<8 ns	<8 ns	<10 ns	<12 ns
Jitter	≤ 5 MHz: 2 ppm + 500 ps >5 MHz: 500 ps			
Amplitude (into 50 Ω)	≤ 20 MHz: 1 mVpp to 10 Vpp ≤ 60 MHz: 1 mVpp to 5 Vpp ≤ 120 MHz: 1 mV to 2.5 Vpp ≤ 200 MHz: 1 mV to 1 Vpp			
Modulation Type	AM, FM, PM, ASK, FSK, PSK, BPSK, QPSK, 3FSK, 4FSK, OSK, and PWM			
Working Mode	Continuous, Burst, Sweep, and Modulation			
Burst Characteristics	Carrier frequency: 2 MHz to 100 MHz (or max. frequency of the instrument) Burst count: 1 to 1 million, or Infinite Trigger source: internal, external, manual			

Order Information

	Description	Order No.
Model	DG4202 (200 MHz, dual-channel function/arbitrary waveform generator)	DG4202
	DG4162 (160 MHz, dual-channel function/arbitrary waveform generator)	DG4162
	DG4102 (100 MHz, dual-channel function/arbitrary waveform generator)	DG4102
	DG4062 (60 MHz, dual-channel function/arbitrary waveform generator)	DG4062
Standard Accessories	USB Cable x1	CB-USBA-USBB-FF-150
	BNC Cable x1 (1 meter)	CB-BNC-BNC-MM-100
	Power Cord Conforming to the Standard of the Destination Country	-
Options	Arbitrary Waveform Editing PC Software (advanced function)	UltraStation-adv
	40 dB Attenuator	RA5040K
	Rack Mount Kit	RM-DG4000
	USB-GPIB Interface Converter	USB-GPIB

DG2000 Series Function/ Arbitrary Waveform Generator



DG2000 series function/arbitrary waveform generator is a multi-functional generator that integrates many functions into one, including Function Generator, Arbitrary Waveform Generator, Noise Generator, Pulse Generator, Pattern Generator, Harmonics Generator, Analog/Digital Modulator and Frequency Counter. The brand new appearance and user-friendly interface design bring you excellent user experience. DG2000 series function/arbitrary waveform generator is the upgrade of DG900. With the newly added standard waveform key, users can switch the standard waveforms freely and conveniently. Besides, with 1UH in width and 2U in height, the DG2000 series function/arbitrary waveform generator is more suitable for the integration test.

- SiFi II technology, generating the arbitrary waveforms points by points, outputting high quality waveforms accurately
- Built-in 8 orders harmonics generator
- Up to 250 MSa/s sample rate and 16 M memory depth
- 4.3" TFT color touch screen and brand new UI design
- PRBS, RS232, and Sequence
- Fan-free mute design

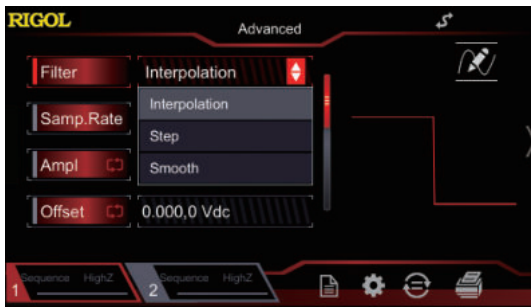

Innovative SiFi technology



PRBS, RS232 Pattern, and Sequence

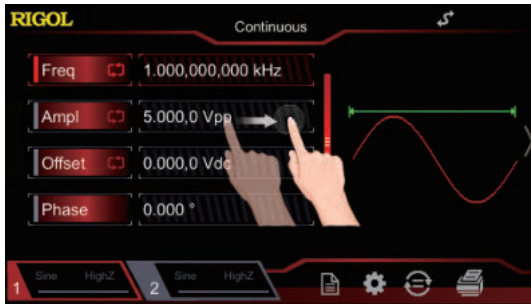

Touch-enabled UI Design (Drag)

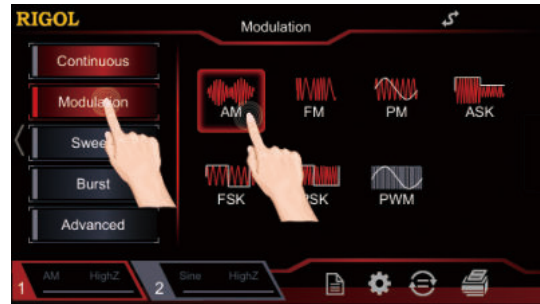

Touch-enabled UI Design (Tap)

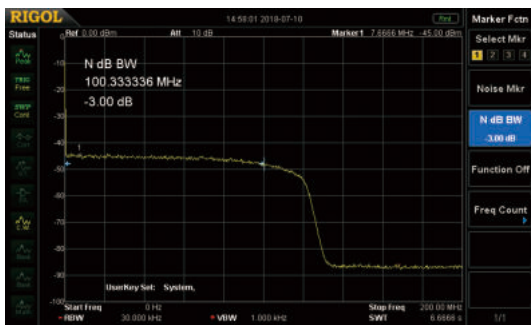

100 MHz Bandwidth White Gaussian Noise

Models and Specifications

Model	DG2052	DG2072	DG2102
No. of Channels	2		
Maximum Output Frequency	50 MHz	70 MHz	100 MHz
Sample Rate	250Msa/s		
Waveform Type	Standard Waveform: Sine, Square, Ramp, Pulse, Noise, Dual-tone, Harmonic (up to 8 orders) Arbitrary Waveform: 160 types of waveforms, including Sinc, Exponential Rise, Exponential Fall, ECG, Gauss, HaverSine, Lorentz, Dual-tone, and DC Advanced Waveform: PRBS, RS232, and Sequence		
Waveform Length	16Mpts		
Vertical Resolution	16bits		
Sine	1 μ Hz to 50 MHz	1 μ Hz to 70 MHz	1 μ Hz to 100 MHz
Square	1 μ Hz to 15 MHz	1 μ Hz to 20 MHz	1 μ Hz to 25 MHz

Model	DG2052	DG2072	DG2102
Ramp	1 μ Hz to 1.5 MHz	1 μ Hz to 1.5 MHz	1 μ Hz to 2 MHz
Pulse	1 μ Hz to 15 MHz	1 μ Hz to 20 MHz	1 μ Hz to 25 MHz
Arbitrary Waveform	1 μ Hz to 15 MHz	1 μ Hz to 20 MHz	1 μ Hz to 20 MHz
Harmonic	1 μ Hz to 20 MHz	1 μ Hz to 20 MHz	1 μ Hz to 25 MHz
Dual-tone	1 μ Hz to 20 MHz	1 μ Hz to 20 MHz	1 μ Hz to 20 MHz
RS232	Baud rate: 9600, 14400, 19200, 38400, 57600, 115200, 128000, 230400		
PRBS	2 kbps to 40 Mbps	2 kbps to 50 Mbps	2 kbps to 60 Mbps
Sequence	2k to 60 MSA/s		
Noise (-3 dB)	100 MHz Bandwidth		
Sine Wave Spectrum Purity	Total harmonic distortion: <0.075% (10 Hz to 20 kHz, 0 dBm); phase noise: <-105 dBc/Hz@10 MHz (0 dBm, 10 kHz offset)		
Square Rise/Fall Time	≤ 9 ns (typ., 1Vpp)		
Jitter	Typ. (1 Vpp) ≤ 5 MHz: 2 ppm + 200 ps >5 MHz: 200 ps		
Amplitude (into 50 Ω)	≤ 10 MHz: 1 mVpp to 10 Vpp ≤ 30 MHz: 1 mVpp to 5 Vpp ≤ 60 MHz: 1 mV to 2.5 Vpp >60MHz: 1 mV to 2.5 Vpp		
Modulation Type	AM, FM, PM, ASK, FSK, PSK, and PWM		
Working Mode	Continuous, Burst, Sweep, and Modulation		
Burst Characteristics	Carrier frequency: 2 MHz-10 MHz/25 MHz/35 MHz/50 MHz/70 MHz/100 MHz; pulse count: 1 to 1 million, or Infinite; trigger source: external, internal, and manual		
Standard Interface	USB Device (on the rear panel) and USB Host		

Order Information

	Description	Order No.
Model	DG2052 (50 MHz, Dual-channel)	DG2052
	DG2072 (70 MHz, Dual-channel)	DG2072
	DG2102 (100 MHz, Dual-channel)	DG2102
Standard Accessories	Power Cord Conforming to the Standard of the Destination Country	-
	USB Cable x1	CB-USBA-USBB-FF-150
	BNC Cable x1	CB-BNC-BNC-MM-100
	Product Warranty Card	-
Options	40 dB Attenuator	RA5040K
	Arbitrary Waveform Editing PC Software (advanced function)	UltraStation-adv
	Rack Mount Kit (for a single instrument)	RM-1-DG1000Z
	Rack Mount Kit (for two instruments)	RM-2-DG1000Z
	USB-GPIB Adaptor	USB-GPIB-L

DG1000Z Series Function/ Arbitrary Waveform Generator



DG1000Z series function/arbitrary waveform generator is a multi-functional generator that integrates many functions into one, including Function Generator, Arbitrary Waveform Generator, Noise Generator, Pulse Generator, Harmonics Generator, Analog/Digital Modulator and Frequency Counter. As a multi-functional, high performance and portable generator, it will be a new selection in education, R&D, production, and test, providing more solutions for users at an affordable price. Its maximum output frequency is 25MHz/30MHz/60MHz. The standard USB and LAN interfaces enable you to control the instrument remotely. All models of this series have two channels with identical functions and phase adjustable between channels.

- Innovative SiFi technology
- 160 built-in arbitrary waveforms
- Various analog and digital modulation functions
- Standard harmonic generator function
- Waveform combine function
- Built-in 7-digit frequency counter

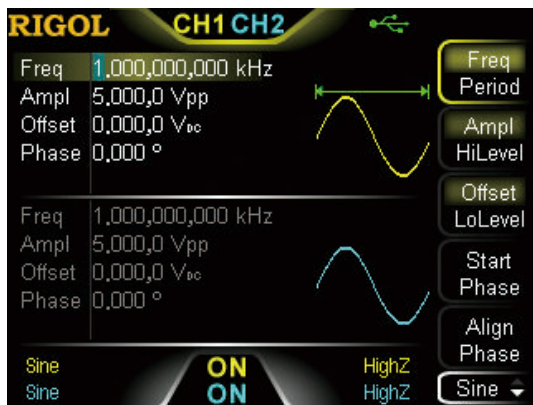

Standard dual channels with the same performance

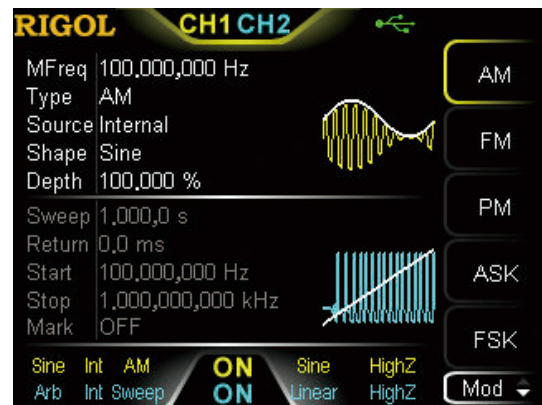

Various analog and digital modulation functions

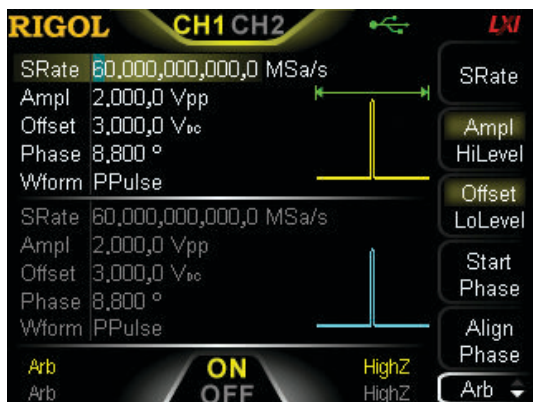

Arbitrary waveform function with innovative SiFi technology

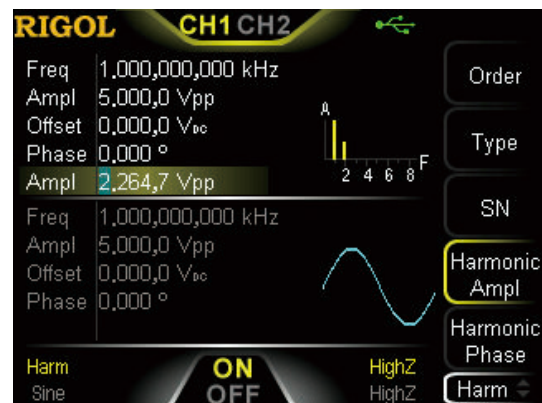

Standard harmonic generator function

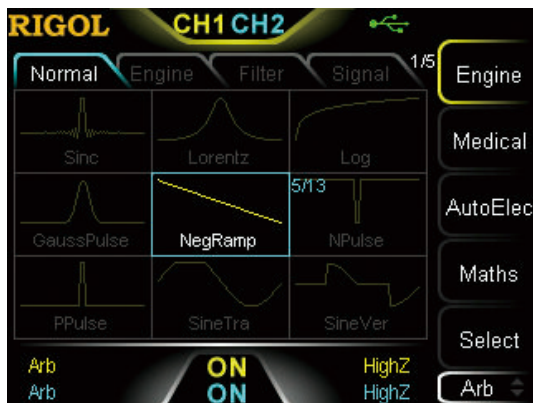

160 built-in arbitrary waveforms

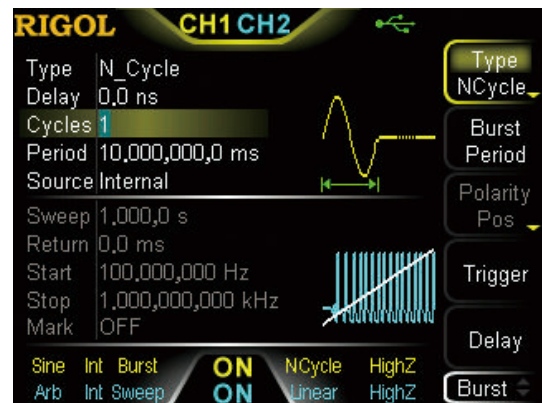

Burst function

Models and Specifications

Model	DG1062Z	DG1032Z	DG1022Z
No. of Channels	2		

Model	DG1062Z	DG1032Z	DG1022Z
Maximum Output Frequency	60 MHz	30 MHz	25 MHz
Sample Rate	200 MSa/s		
Waveform Type	Standard Waveforms: Sine, Square, Ramp, Pulse, Noise, Harmonics (up to 8 orders) Arbitrary Waveforms: 160 waveforms including Sinc, Exponential Rise, Exponential Fall, ECG, Gauss, HaverSine, Lorentz, Dual-Tone, and DC		
Waveform Length	8 pts to 8 Mpts (opt.16 Mpts)		8 pts to 2 Mpts (opt.16 Mpts)
Vertical Resolution	14 bits		
Sine	1 μ Hz to 25 MHz	1 μ Hz to 30 MHz	1 μ Hz to 25 MHz
Square	1 μ Hz to 25 MHz	1 μ Hz to 25 MHz	1 μ Hz to 25 MHz
Ramp	1 μ Hz to 1 MHz	1 μ Hz to 500 KHz	1 μ Hz to 500 KHz
Pulse	1 μ Hz to 25 MHz	1 μ Hz to 15 MHz	1 μ Hz to 15 MHz
Arb/Harmonics	1 μ Hz to 20 MHz	1 μ Hz to 10 MHz	1 μ Hz to 10 MHz
Noise (-3 dB)	60 MHz BW	30 MHz BW	25 MHz BW
Sine Wave Spectrum Purity	Total Harmonic Distortion <0.075% (10 Hz-20 KHz, 0 dBm); Phase Noise <-125 dBc@10 MHz (0 dBm,10 KHz offset)		
Square Rise/Fall Time	Typ. (1 Vpp) <10 ns		
Jitter (rms)	Typical (1 Vpp) \leq 5 MHz: 2 ppm + 200 ps >5 MHz: 200 ps		
Amplitude (into 50 Ω)	\leq 10 MHz: 1 mVpp-10 Vpp \leq 30MHz: 1 mVpp-5 Vpp \leq 60 MHz: 1 mV-2.5 Vpp		
Modulation Type	AM, FM, PM, ASK, FSK, PSK, and PWM		
Working Mode	Continuous, Burst, Sweep, and Modulation		
Burst Characteristics	Carrier frequency: 2 mHz to 25MHz/30MHz/60MHz Burst count: 1 to 1 million, or Infinite Trigger source: internal, external, manual		
Standard Interface	USB Device (on the front panel), USB Host, LAN (LXI-C), USB-GPIB (opt.)		

Order Information

	Description	Order No.
Model	DG1022Z (25MHz, Dual-channel)	DG1022Z
	DG1032Z (30MHz, Dual-channel)	DG1032Z
	DG1062Z (60MHz, Dual-channel)	DG1062Z
Standard Accessories	USB Cable x1	CB-USBA-USBB-FF-150
	BNC Cable x1	CB-BNC-BNC-MM-100
	Power Cord Conforming to the Standard of the Destination Country	

	Description	Order No.
Options	16M Internal Memory	Arb16M-DG1000Z
	Arbitrary Waveform Editing PC Software (advanced function)	UltraStation-adv
	40 dB Attenuator	RA5040K
	10W Power Amplifier	PA1011
	Rack Mount Kit (for a single instrument)	RM-1-DG1000Z
	Rack Mount Kit (for two instruments)	RM-2-DG1000Z
	USB-GPIB Adaptor	USB-GPIB

DG1000 Series Function/ Arbitrary Waveform Generator



DG1000 series dual-channel function/arbitrary waveform generator adopts Direct Digital Synthesis (DDS) technology, which enables to generate stable, high-precision, pure and low distortion signals.

- Built-in high-precision and wide-band frequency counter, with a measurement range from 100 MHz to 200 MHz (single channel)
- Standard interfaces: USB Device, USB Host
- Seamlessly interconnect with DS1000 series digital oscilloscope
- Powerful arbitrary waveform editing software (UltraWave)
- Supports remote command control
- Adopt advanced DDS technology; dual channel output; 100 MSa/s sample rate; 14 bits vertical resolution
- Output 5 standard waveforms; 48 built-in arbitrary waveforms
- Abundant modulation functions: AM, FM, PM and FSK
- Provide linear/logarithm sweep and burst
- Abundant output and input interfaces: waveform output; synchronous signal output, external modulation source, external clock reference (10 MHz) input, external trigger input
- Channel coupling and channel copy

Models and Specifications

Model	DG1022	DG1022A
No. of Channels	2	
Sample Rate	100MSa/s	
Waveform Type	Standard Waveforms: Sine, Square, Ramp, Pulse, Noise Arbitrary Waveforms: 160 waveforms including Sinc, Exponential Rise, Exponential Fall, ECG, Gauss, HaverSine, Lorentz, Dual-Tone, and DC	
Waveform Length	4 kpts	1 kpts
Vertical Resolution	14 bits	
Sine	1 μ Hz to 20 MHz	1 μ Hz to 25 MHz
Square	1 μ Hz to 5 MHz	1 μ Hz to 5 MHz
Ramp	1 μ Hz to 150 kHz	1 μ Hz to 500 kHz
Pulse	500 μ Hz to 3 MHz	500 μ Hz to 5 MHz
Arbitrary Waveform	1 μ Hz to 5 MHz	1 μ Hz to 5 MHz
Amplitude (into 50 Ω)	CH1: 2 mVpp to 10 Vpp CH2: 2mVpp to 3Vpp	CH1: \leq 20 MHz: 2 mVpp to 10 Vpp; $>$ 20MHz: 2 mVpp to 5 Vpp CH2: 2 mVpp to 3 Vpp
Noise	5 MHz BW (-3 dB)	
Sine Wave Spectrum Purity	Total Harmonic Distortion: $<$ 0.2% (DC to 20 kHz, 1 Vpp) Phase Noise: -108 dBc@10 KHz offset (typ.)	
Square Rise/Fall Time	$<$ 20 ns (10% to 90%, typ., 1 kHz, 1 Vpp)	
Jitter	6 ns + 0.1% of period (typ., 1 kHz, 1 Vpp)	
Modulation Type	AM, FM, PM, and FSK	

Order Information

	Description	Order No.
Model	DG1022 (20 MHz, 100 MSa/s, Dual-channel)	DG1022
	DG1022A (25 MHz, 100 MSa/s, Dual-channel)	DG1022A
Standard Accessories	USB Cable x1	CB-USBA-USBB-FF-150
	BNC Cable x1	CB-BNC-BNC-MM-100
	Power Cord Conforming to the Standard of the Destination Country	-
Options	BNC-to-Alligator Clip Cable	-
	USB Cable	-
	40 dB Attenuator	RA5040K
	Power Amplifier	PA1011

DG900 Series Function/Arbitrary Waveform Generator



DG900 series function/arbitrary waveform generator is a multi-functional generator that integrates many functions into one, including Function Generator, Arbitrary Waveform Generator, Noise Generator, Pulse Generator, Pattern Generator, Harmonics Generator, Analog/Digital Modulator and Frequency Counter. The brand new appearance and user-friendly interface design bring you excellent user experience.

- SiFi II technology, generating the arbitrary waveforms points by points, outputting high quality waveforms accurately
- Built-in 8 orders harmonics generator
- Up to 250 MSa/s sample rate and 16 M memory depth
- 4.3" TFT color touch screen and brand new UI design
- PRBS, RS232, and Sequence
- Fan-free mute design



Innovative SiFi II technology



PRBS, RS232 pattern, and sequence

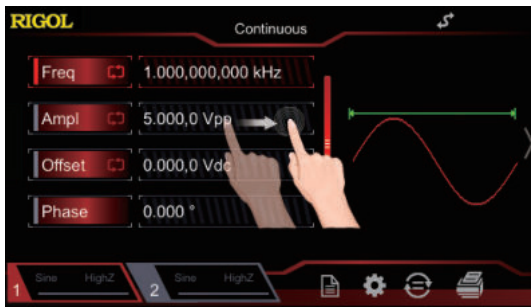

Touch-enabled UI design (drag)

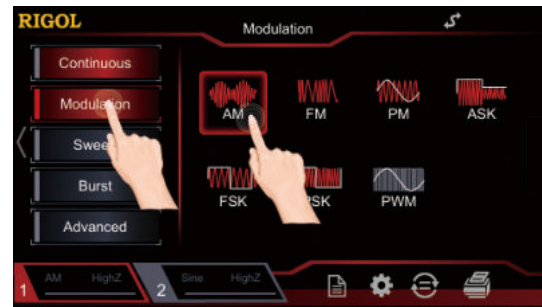

Touch-enabled UI design (tap)

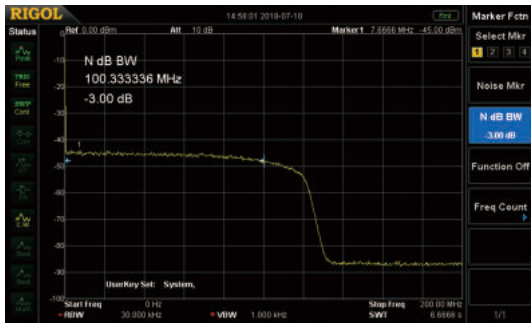

100 MHz bandwidth white Gaussian noise

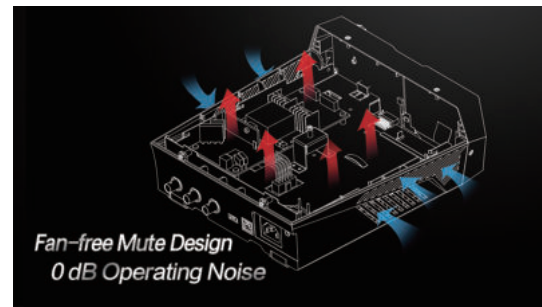

Fan-free mute design

Models and Specifications

Model	DG952	DG972	DG992
No. of Channels	2		
Max. Output Frequency	50 MHz	70 MHz	100 MHz
Sample Rate	250 MSa/s		
Waveform Type	Standard Waveform: Sine, Square, Ramp, Pulse, Noise, Dual-tone, Harmonic (up to 8 orders) Arbitrary Waveform: 160 types of waveforms, including Sinc, Exponential Rise, Exponential Fall, ECG, Gauss, HaverSine, Lorentz, Dual-tone, and DC Advanced Waveform: PRBS, RS232, and Sequence		
Waveform Length	16 Mpts		
Vertical Resolution	16 bits		
Sine	1 μ Hz to 50 MHz	1 μ Hz to 70 MHz	1 μ Hz to 100 MHz
Square	1 μ Hz to 15 MHz	1 μ Hz to 20 MHz	1 μ Hz to 25 MHz
Ramp	1 μ Hz to 1.5 MHz	1 μ Hz to 1.5 MHz	1 μ Hz to 2 MHz
Pulse	1 μ Hz to 15 MHz	1 μ Hz to 20 MHz	1 μ Hz to 25 MHz
Arbitrary Waveform	1 μ Hz to 15 MHz	1 μ Hz to 20 MHz	1 μ Hz to 20 MHz
Harmonic	1 μ Hz to 20 MHz	1 μ Hz to 20 MHz	1 μ Hz to 25 MHz
Dual-tone	1 μ Hz to 20 MHz	1 μ Hz to 20 MHz	1 μ Hz to 20 MHz
RS232	Baud rate: 9600, 14400, 19200, 38400, 57600, 115200, 128000, 230400		
PRBS	2 kbps to 40 Mbps	2 kbps to 50 Mbps	2 kbps to 60 Mbps

Model	DG952	DG972	DG992
Sequence	2k to 60 MSa/s		
Noise (-3 dB)	100 MHz Bandwidth		
Sine Wave Spectrum Purity	Total harmonic distortion: <0.075% (10 Hz to 20 kHz, 0 dBm) Phase noise: <-105 dBc/Hz@10 MHz (0 dBm, 10 kHz offset)		
Square Rise/Fall Time	≤9 ns (typ., 1Vpp)		
Jitter	Typ. (1 Vpp) ≤5 MHz: 2 ppm + 200 ps >5 MHz: 200 ps		
Amplitude (into 50 Ω)	≤10MHz: 1 mVpp to 10 Vpp ≤30 MHz: 1 mVpp to 5 Vpp ≤60 MHz: 1 mV to 2.5 Vpp >60 MHz: 1 mV to 2.5 Vpp		
Modulation Type	AM, FM, PM, ASK, FSK, PSK, and PWM		
Working Mode	Continuous, Burst, Sweep, and Modulation		
Burst Characteristics	Carrier frequency: 2 MHz-10 MHz/25 MHz/35 MHz/50 MHz/70 MHz/100 MHz Pulse count: 1 to 1 million, or Infinite Trigger source: external, internal, and manual		
Standard Interface	USB Device (on the rear panel) and USB Host		

Order Information

	Description	Order No.
Model	DG952 (50 MHz, Dual-channel)	DG952
	DG972 (70 MHz, Dual-channel)	DG972
	DG992 (100 MHz, Dual-channel)	DG992
Standard Accessories	Power Cord Conforming to the Standard of the Destination Country	-
	USB Cable x1	CB-USBA-USBB-FF-150
	BNC Cable x1	CB-BNC-BNC-MM-100
	Product Warranty Card	-
Options	40 dB Attenuator	RA5040K
	Arbitrary Waveform Editing PC Software (advanced function)	UltraStation-adv
	USB-GPIB Adaptor	USB-GPIB-L

DG800 Series Function/Arbitrary Waveform Generator



DG800 series function/arbitrary waveform generator is a multi-functional generator that integrates many functions into one, including Function Generator, Arbitrary Waveform Generator, Noise Generator, Pulse Generator, Pattern Generator, Harmonics Generator, Analog/Digital Modulator and Frequency Counter. The brand new appearance and user-friendly interface design bring you excellent user experience.

- SiFi II technology, generating the arbitrary waveforms points by points, outputting high quality waveforms accurately
- Built-in 8 orders harmonics generator
- Wave superposition and channel tracking (std.)
- 4.3" TFT color touch screen and brand new UI design
- PRBS, RS232, and Sequence
- Fan-free mute design



Innovative SiFi II technology



PRBS, RS232 pattern, and sequence

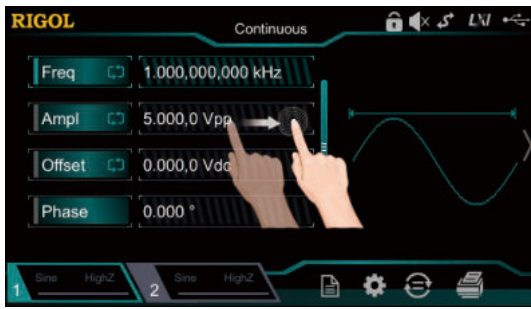

Touch-enabled UI design (drag)

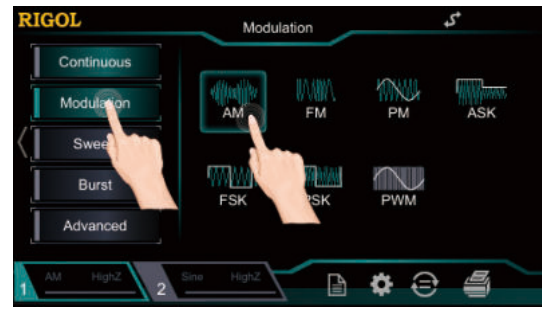

Touch-enabled UI design (tap)

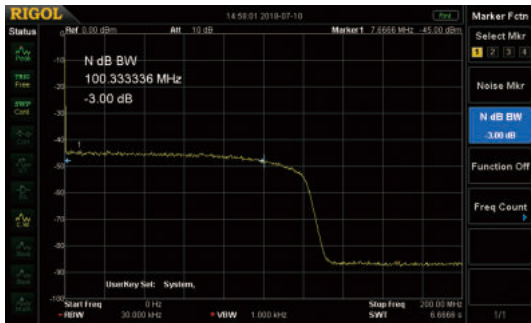

100 MHz Bandwidth White Gaussian Noise

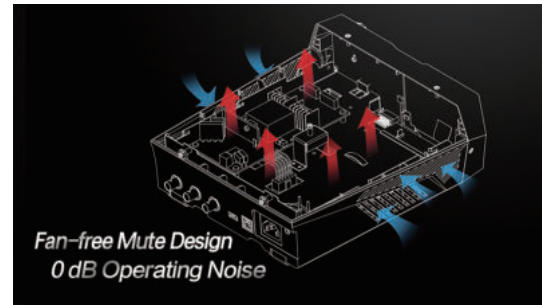

Fan-free mute design

Models and Specifications

Model	DG811/2	DG821/2	DG831/2
No. of Channels	1/2		
Max. Output Frequency	10 MHz	25 MHz	35 MHz
Sample Rate	125MSa/s		
Waveform Type	Standard Waveform: Sine, Square, Ramp, Pulse, Noise, Dual-tone, Harmonic (up to 8 orders) Arbitrary Waveform: 160 types of waveforms, including Sinc, Exponential Rise, Exponential Fall, ECG, Gauss, HaverSine, Lorentz, Dual-tone, and DC Advanced Waveform: PRBS, RS232, and Sequence		
Waveform Length	2 Mpts (opt. 8 Mpts)		
Vertical Resolution	16 bits		
Sine	1 μ Hz to 10 MHz	1 μ Hz to 25 MHz	1 μ Hz to 35 MHz
Square	1 μ Hz to 5 MHz	1 μ Hz to 10 MHz	1 μ Hz to 10 MHz
Ramp	1 μ Hz to 200 kHz	1 μ Hz to 500 kHz	1 μ Hz to 1 MHz
Pulse	1 μ Hz to 5 MHz	1 μ Hz to 10 MHz	1 μ Hz to 10 MHz
Arbitrary Waveform	1 μ Hz to 5 MHz	1 μ Hz to 10 MHz	1 μ Hz to 10 MHz
Harmonic	1 μ Hz to 5 MHz	1 μ Hz to 10 MHz	1 μ Hz to 15 MHz
Dual-tone	1 μ Hz to 10 MHz	1 μ Hz to 20 MHz	1 μ Hz to 20 MHz
RS232	Baud rate: 9600, 14400, 19200, 38400, 57600, 115200, 128000, 230400		
PRBS	2 kbps to 10 Mbps	2 kbps to 20 Mbps	2 kbps to 30 Mbps

Model	DG811/2	DG821/2	DG831/2
Sequence	2 kSa/s to 30 MSa/s		
Noise (-3 dB)	100 MHz Bandwidth		
Sine Wave Spectrum Purity	Total harmonic distortion: <0.075% (10 Hz to 20 kHz, 0 dBm) Phase noise: <-105 dBc/Hz@10 MHz (0 dBm, 10 kHz offset)		
Square Rise/Fall Time	≤9 ns (typ., 1Vpp)		
Jitter	Typ. (1 Vpp) ≤5 MHz: 2 ppm + 200 ps >5 MHz: 200 ps		
Amplitude (into 50 Ω)	≤10MHz: 1 mVpp to 10 Vpp ≤30 MHz: 1 mVpp to 5 Vpp ≤60 MHz: 1 mV to 2.5 Vpp >60MHz: 1 mV to 2.5 Vpp		
Modulation Type	AM, FM, PM, ASK, FSK, PSK, and PWM		
Working Mode	Continuous, Burst, Sweep, and Modulation		
Burst Characteristics	Carrier frequency: 2 MHz-10 MHz/25 MHz/35 MHz/50 MHz/70 MHz/100 MHz Pulse count: 1 to 1 million, or Infinite Trigger source: external, internal, and manual		
Standard Interface	USB Device (on the rear panel) and USB Host		

Order Information

	Description	Order No.
Model	DG812 (10 MHz, Dual-channel)	DG812
	DG822 (25 MHz, Dual-channel)	DG822
	DG832 (35 MHz, Dual-channel)	DG832
	DG811 (10 MHz, Single-channel)	DG811
	DG821 (25MHz, Single-channel)	DG821
	DG831 (35MHz, Single-channel)	DG831
Standard Accessories	Power Cord Conforming to the Standard of the Destination Country	-
	BNC Cable x1 (only available for DG832/DG831/DG822/DG821)	CB-BNC-BNC-MM-100
	Product Warranty Card	-
Options	Dual-channel Option (only available for DG831/DG821/DG811)	DG800-DCH
	Arbitrary Waveform Editing PC Software (advanced function)	UltraStation-adv
	2M-8M Arbitrary Waveform Memory Depth Upgrade Option	DG800-ARB8M

	Description	Order No.
Optional Accessories	40 dB Attenuator	RA5040K
	USB-GPIB Interface Converter	USB-GPIB-L

Spectrum Analyzers



RIGOL's RSA series (including RSA5000 series, RSA3000 series, and RSA3000(E) series) are the first full-function real-time spectrum analyzers in China. Being equipped with the patented technology Ultra Real, it has a high performance at an affordable price. The superb specifications and outstanding performance can be delivered both in GPSA, RTSA, VSA, and EMI working modes. With a high-definition 10.1" capacitive multi-touch screen, it supports various touch gestures. You can also operate it with the externally connected keyboard and mouse. It has the built-in Linux system, and the HDMI interface is available for you to make the communication interface more stable and reliable. It can be widely applied to corporate R&D, factory production, education teaching, and other fields. The RSA series real-time spectrum analyzer delivers excellent performance with an affordable price, enabling you to further improve measurement quality at low costs.

DSA800 series, DSA800E series, and DSA700 series spectrum analyzers adopt the latest digital IF technology. These spectrum analyzer products cover different frequency ranges, and its frequency can reach up to 7.5 GHz, the Displayed Average Noise Level (DANL) as low as -161 dBm, phase noise below -98 dBc/Hz, RBW 10 Hz. These specifications reach the international advanced level of the same product category. To meet the demands of different users, these spectrum analyzers are also equipped with standard and optional accessories, such as preamplifier (PA), tracking generator (TG), VSA application software, EMI pre-compliance test software, advanced measurement kit (AMK), VSWR measurement kit, teaching kit, VSWR bridge, cable, and adaptor.

Model	Frequency Band	Max. RTBW	Min. RBW	Phase Noise@10kHz offset
RSA5065/-TG/N	6.5 GHz	40 MHz	1 Hz	-108 dBc/Hz
RSA5032/-TG/N	3.2 GHz	40 MHz	1 Hz	-108 dBc/Hz
RSA3045/-TG/N	4.5 GHz	40 MHz	1 Hz	-102 dBc/Hz
RSA3030/-TG/N	3 GHz	40 MHz	1 Hz	-102 dBc/Hz
RSA3030E/-TG	3 GHz	10 MHz	1 Hz	-102 dBc/Hz
RSA3015E/-TG	1.5 GHz	10 MHz	1 Hz	-102 dBc/Hz
RSA3015N	1.5 GHz	40 MHz	1 Hz	-102 dBc/Hz

Model	Frequency Band	Max. RTBW	Min. RBW	Phase Noise@10kHz offset
DSA875/-TG	7.5 GHz	-	10 Hz	-98 dBc/Hz
DSA832/-TG	3.2 GHz	-	10 Hz	-98 dBc/Hz
DSA832E/-TG	3.2 GHz	-	10 Hz	-90 dBc/Hz
DSA815/-TG	1.5 GHz	-	10 Hz	-80 dBc/Hz
DSA710	1 GHz	-	100 Hz	-80 dBc/Hz
DSA705	0.5 GHz	-	100 Hz	-80 dBc/Hz

Model	Software Options						Hardware Options	
	Vector Signal Analysis Meas. Application	EMI Meas. Application	VNA	Advanced Meas.	EMC Filter and Quasi-Peak Detector Kit	VSWR	TG	Preamp
RSA5065/-TG/N	○	○	N models only	○	●	●	-TG/N Model	○
RSA5032/-TG/N	○	○	N models only	○	●	●	-TG/N Model	○
RSA3045/-TG/N		○	N models only	○	○	●	-TG/N Model	○
RSA3030/-TG/N		○	N models only	○	○	●	-TG/N Model	○
RSA3030E/-TG		○		○	○	●	-TG Model	○
RSA3015E/-TG		○		○	○	●	-TG Model	○
RSA3015N		○	●	○	○	●	N Model	○
DSA875/-TG				○	○	○	-TG Model	●
DSA832/-TG				○	○	○	-TG Model	●
DSA832E/-TG				○	○	○	-TG Model	●
DSA815/-TG				○	○	○	-TG Model	●
DSA710				○	○		-	●
DSA705				○	○		-	●

NOTE:

●: Standard ○: Option

RSA5000 Series Spectrum Analyzer



The RSA5000 series real-time spectrum analyzer includes six models: RSA5065, RSA5065-TG, RSA5032, RSA5032-TG, RSA5065N, and RSA5032N. The -TG model is equipped with the tracking generator. The frequency band range: 9 kHz to 6.5 GHz; 9 kHz to 3.2 GHz. The RSA5000 series has a standard configuration of GPSA and RTSA modes, capable of delivering excellent performance at low costs.

The RSA5000 series is a real-time spectrum analyzer built on the Ultra Real technical platform. Both in the GPSA and RTSA working modes, it can deliver excellent specifications. The general-purpose spectrum analyzer may not fully capture the signal due to the deadtime and slow sweep, which may even result in signal loss. Compared with the general-purpose spectrum analyzer, the real-time spectrum analyzer can perfectly address this issue. The RSA series real-time spectrum analyzer is equipped with the VSA and EMI functions. The VSA mode enables users to make comprehensive and detailed analysis and measurement of vector signals in time domain, frequency domain, and modulation domain. EMI measurement application software allows users to perform pre-compliance test and diagnosis evaluation before formal EMI certification for the product. The EMI mode enables users to perform EMI pre-compliance test that meets the CISPR standards, help users to identify the EMI compliance problem and ensure that the new design can pass the final certification test at one time.

- Ultra-Real technology
- Frequency: up to 6.5 GHz
- Analog/digital modulation
- Displayed average noise level (DANL): <-165 dBm (typical)
- Phase noise: <-108 dBc/Hz (typical)
- Level measurement uncertainty: <0.8 dB
- 6.5 GHz tracking generator
- Min. RBW 1 Hz
- Up to 40 MHz real-time analysis bandwidth
- Multiple measurement modes
- USB, LAN, HDMI and other communication and display interfaces
- 10.1" capacitive multi-touch screen; supporting touch gestures
- PC software options
- Density, Spectrogram, and other display modes available for you to observe the real-time measurement results
- Multiple trigger modes and trigger masks
- Vector network analysis software
- EMI measurement application (opt.)
- Vector signal analysis measurement application (opt.)
- Various advanced measurements

GPSA is a swept working mode for the general-purpose spectrum analyzer. Compared with DSA800/E and DSA700 series, its key specifications such as phase noise, DANL, RBW, and sweep speed have been greatly enhanced.

RTSA is a real-time working mode, which can seamlessly capture the transient signal, and display the measurement results completely through the Density view, Spectrogram view, etc. Users can set the FMT trigger mode to accurately capture the desired signal of interest.

In VNA mode, you can make S11, S21, and DTF measurements for the components and circuit networks. The network characteristics of the components under test can be accurately demonstrated in Smith chart, Polar chart, and other formats.

Built-in VNA mode (N model)



In VNA mode, you can make S11, S21, and DTF measurements for the components and circuit networks. The network characteristics of the components under test can be accurately demonstrated in Smith chart, Polar chart, and other formats.

Discover transient anomalies through Ultra Real

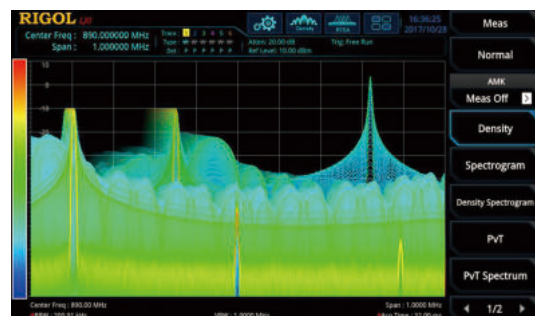

The RSA5000 series delivers up to 40 MHz of real-time bandwidth using the innovative Ultra Real technology. In the real-time bandwidth range, transient signals exceeding 7.45 μ s duration can be guaranteed to be 100% captured and accurately measured.

Identify problems in design with vector analysis



The VSA supports a variety of digital modulation formats such as QAM, PSK, MSK, ASK, FSK, etc. This function is used to quickly demodulate and display multi-dimensional data such as its constellation, eye diagram (baseband signal), spectrogram, demodulation data, etc., to locate problems in the design.

Conduction/radiation pre-testing with built-in EMI test



The built-in EMI pre-compliance test application software, combined with CISPR-compliant filters, makes a pre-compliance test on the product for conduction and radiation to identify and improve its conduction/radiation disturbance source and accelerate time-to-market.

Signal triggering and monitoring via FMT template



The FMT frequency mask trigger is a unique trigger mode for real-time spectrum analyzers. You can quickly build a template and accurately locate and trigger signals that match the template rules to detect sporadic anomalies within the monitored range.

Multiple interfaces for connectivity



The instrument can be connected to a larger display/monitor via the HDMI interface for better display effects. The Web Control function allows you to directly control the device by accessing the device IP address, improving remote control user experience.

Operate the instrument with gesture-enabled multi-touch screen



Excellent phase noise

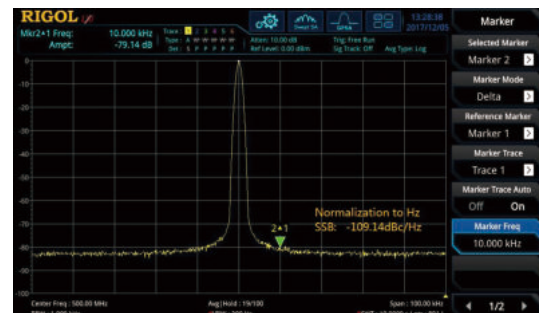

The RSA5000 series provides a 10.1-inch capacitive multi-touch screen, supports a variety of gestures such as dragging, expanding, and zooming waveforms to provide convenient and friendly user experience.

Excellent sweep specifications; phase noise low as -108 dBc/Hz.

Models and Specifications

Model		RSA5032/-TG/N	RSA5065/-TG/N
Frequency Range		9 kHz to 3.2 GHz	9 kHz to 6.5 GHz
Frequency Stability	0°C to 50°C, with the reference 25°C		
	Standard	<0.5 ppm	
	Option OCXO-C08	<0.005 ppm	
Phase Noise	10 kHz, $f_c = 500$ MHz	<-106 dBc/Hz (typ.), <-108 dBc/Hz (typ.)	
Resolution Bandwidth (-3 dB)		1 Hz to 10 MHz; in 1-3-10 step	
Resolution Bandwidth (-6 dB)		200 Hz, 9 kHz, 120 kHz, 1 MHz	
Displayed Average Noise Level (DANL)		Preamp on, attenuation = 0 dB, sample detector, trace averages ≥ 50 , tracking generator off, normalized to 1 Hz, 20°C to 30°C, input impedance = 50 Ω . <-162 dBm, <-165 dBm (typ.)	
Level Measurement Uncertainty		<0.8 dB (nom.)	
TG Frequency Range (only available for -TG and N models)		100 kHz to 3.2 GHz	100 kHz to 6.5 GHz
TG Output Level Range (only available for -TG and N models)		-40 dBm to 0 dBm	-40 dBm to 0 dBm
Real-time Analysis Bandwidth or I/Q Demodulation Bandwidth		25 MHz, 40 MHz (Option RSA5000-B40)	
Full-scale Accuracy		maximum span; default Kaiser Window	
Min. Signal Duration for 100% POI at the Full-Scale Accuracy		7.45 μ s	
Window Type		Hanning, Blackman-Harris, Rectangular, Flattop, Kaiser, Gaussian	
Max. Sample Rate		51.2 MSa/s	
FFT Rate		146,484/s (nominal)	
SFDR		mixer level = -30 dBm <-60 dBc/Hz (typical)	
Trigger Source		Free Run, External, Power, FMT	

Model	RSA5032/-TG/N	RSA5065/-TG/N	
VNA Mode (only available for N models)	Meas Setup		
	Measurement Type	S11, S21, and DTF	
	Measurement Bandwidth	1 kHz to 10 MHz (in 1-3-10 step)	
	Data Points	101 to 10,001; default 201	
	Transmission Measurement S21		
	Trace Format	Lin Mag, Log Mag, Phase, Group Delay	
	Dynamic Range	S21, RBW = 10 kHz, Port1 level = 0 dBm, Log Mag, Average = 50	
		80 dB (nominal)	
	Reflection Measurement S11		
	Trace Format	Lin Mag, Log Mag, Phase, Group Delay, SWR	
Smith Chart (Lin/Phase, Log/Phase, Real/Imag, R+j*X, G+j*B)			
Polar Chart (Lin/Phase, Log/Phase, Real/Imag)			
Corrected Directivity (With CK106A)	S11, Log Mag, Average = 50		
	>40 dB (nom.)		

Order Information

	Description	Order No.
Model	RSA5032 (Real-time Spectrum Analyzer, 9 kHz to 3.2 GHz)	RSA5032
	RSA5065 (Real-time Spectrum Analyzer, 9 kHz to 6.5 GHz)	RSA5065
	RSA5032-TG (Real-time Spectrum Analyzer, 9 kHz to 3.2 GHz, with tracking generator installed before leaving factory)	RSA5032-TG
	RSA5065-TG (Real-time Spectrum Analyzer, 9 kHz to 6.5 GHz, with tracking generator installed before leaving factory)	RSA5065-TG
	RSA5032N (Real-time Spectrum Analyzer, 9 kHz to 3.2 GHz, with tracking generator, VNA supported)	RSA5032N
	RSA5065N (Real-time Spectrum Analyzer, 9 kHz to 6.5 GHz, with tracking generator, VNA supported)	RSA5065N
Standard Accessories	Power Cord Conforming to the Standard of the Destination Country	-
Options	Vector Signal Analysis Measurement Application	RSA5000-VSA
	EMI Measurement Application	RSA5000-EMI
	Preamplifier (PA)	RSA5000-PA
	High Stable Clock (Required to be installed and calibrated before leaving factory)	OEXO-C08
	Real-time Analysis Bandwidth 40 MHz	RSA5000-B40
	Advanced Measurement Kit	RSA5000-AMK
	Spectrum Analyzer PC Software	Ultra Spectrum
	EMI Pre-compliance Test Software	S1210 EMI Pre-compliance Software

NOTE:

For other optional accessories of the RF instrument, please refer to [*RF Accessories Selection Guide*](#).

RSA3000 Series Spectrum Analyzer



The RSA3000 series real-time spectrum analyzer includes seven models: RSA3015N, RSA3030, RSA3030-TG, RSA3030N, RSA3045, RSA3045-TG, and RSA3045N. The -TG model is equipped with the tracking generator. The frequency band range: 9 kHz to 1.5 GHz; 9 kHz to 3 GHz; 9 kHz to 4.5 GHz. The RSA3000 series has a standard configuration of GPSA and RTSA modes, capable of delivering excellent performance at low costs.

The RSA3000 series is a real-time spectrum analyzer built on the Ultra Real technical platform. Both in the GPSA and RTSA working modes, it can deliver excellent specifications. The general-purpose spectrum analyzer may not fully capture the signal due to the deadtime and slow sweep, which may even result in signal loss. Compared with the general-purpose spectrum analyzer, the real-time spectrum analyzer can perfectly address this issue.

EMI measurement application software allows users to perform pre-compliance test and diagnosis evaluation before formal EMI certification for the product. The EMI mode enables users to perform EMI pre-compliance test that meets the CISPR standards, help users to identify the EMI compliance problem and ensure that the new design can pass the final certification test at a time.

- Ultra-Real technology
- Frequency: up to 4.5 GHz
- Displayed average noise level (DANL): < -161 dBm (typ.)
- Phase noise: < -102 dBc/Hz (typ.)
- Level measurement uncertainty: < 1.0 dB
- 4.5 GHz tracking generator
- Min. RBW 1 Hz
- Up to 40 MHz real-time analysis bandwidth
- Various measurement functions
- EMI measurement application (opt.)
- Vector network analysis software
- Multiple trigger modes and trigger masks
- Density, Spectrogram, and other display modes
- PC software options
- 10.1" capacitive multi-touch screen; supporting touch gestures
- USB, LAN, HDMI and other communication and display interfaces

Built-in VNA mode (N model)



In VNA mode, you can make S11, S21, and DTF measurements for the components and circuit networks. The network characteristics of the components under test can be accurately demonstrated in Smith chart, Polar chart, and other formats.

Signal triggering and monitoring via FMT template

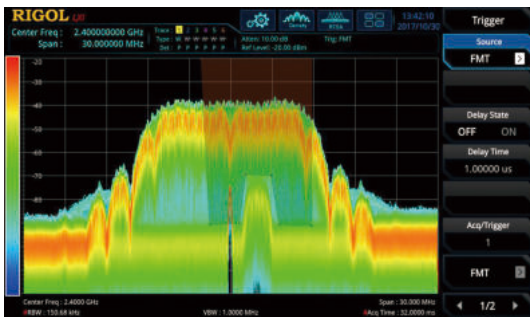

The FMT frequency mask trigger is a unique trigger mode for real-time spectrum analyzers. You can quickly build a template and accurately locate and trigger signals that match the template rules to detect sporadic anomalies within the monitored range.

Excellent phase noise reduces the impact on the weak signal testing.



Conduction/radiation pre-testing with built-in EMI test



The built-in EMI pre-compliance test application software, combined with CISPR-compliant filters, makes a pre-compliance test on the product for conduction and radiation to identify and improve its conduction/radiation disturbance source and accelerate time-to-market.

Resolution bandwidth as low as 1 Hz

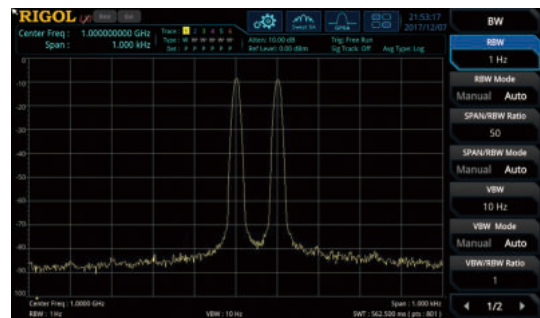

Resolving signals with similar frequencies is critical to verifying many RF devices and systems. With the RSA3000, the 1 Hz RBW allows you to view more details of adjacent signals.

Multiple interfaces for connectivity



The testing for the weak signals is liable to be influenced by the noise floor of the spectrum analyzer itself. DANL low as -161 dBm can effectively ensure the testing for the weak signals.

The instrument can be connected to a larger display/monitor via the HDMI interface for better display effects. The Web Control function allows you to directly control the device by accessing the device IP address, improving remote control user experience.

Operate the instrument with gesture-enabled multi-touch screen



The RSA3000 series provides a 10.1-inch capacitive multi-touch screen, supports a variety of gestures such as dragging, expanding, and zooming waveforms to provide convenient and friendly user experience.

Excellent phase noise

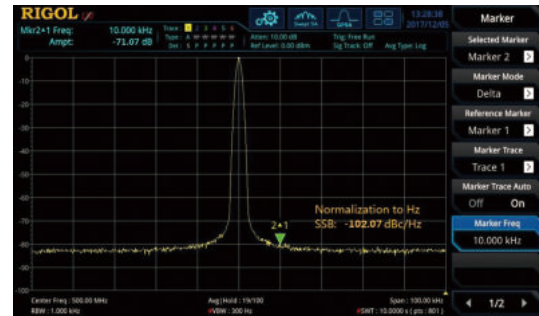

Excellent sweep specifications; phase noise low as -102 dBc/Hz.

Models and Specifications

Model	RSA3015N	RSA3030/-TG/N	RSA3045/-TG/N
Frequency Range	9 kHz to 1.5 GHz	9 kHz to 3.0 GHz	9 kHz to 4.5 GHz
Frequency Stability	0°C to 50°C, with the reference 25°C		
	Standard	<0.5 ppm	
	Option OCXO-C08	<0.005 ppm	
Phase Noise	10 kHz, $f_c = 500$ MHz <-100 dBc/Hz, <-102 dBc/Hz (typ.)		
Resolution Bandwidth (-3 dB)	1 Hz to 3 MHz (option 1 Hz to 10 MHz); in 1-3-10 step		
Resolution Bandwidth (-6 dB, option)	200 Hz, 9 kHz, 120 kHz, 1 MHz		
Displayed Average Noise Level (DANL)	Preamp on, attenuation = 0 dB, sample detector, trace averages ≥ 50 , tracking generator off, normalized to 1 Hz, 20°C to 30°C, input impedance = 50 Ω .		
	<-158 dBm, <-161 dBm (typ.)		
Level Measurement Uncertainty	<1.0 dB (nom.)		
TG Frequency Range (only available for -TG and N models)	100 kHz to 1.5 GHz	100 kHz to 3 GHz	100 kHz to 4.5 GHz
TG Output Level Range (only available for -TG and N models)	-40 dBm to 0 dBm	-40 dBm to 0 dBm	-40 dBm to 0 dBm
Real-time Analysis Bandwidth	Support upgrading: 10 MHz (std.), 25 MHz (Option RSA3000-B25), 40 MHz (Option RSA3000-B40)		

Model		RSA3015N	RSA3030/-TG/N	RSA3045/-TG/N
Full-scale Accuracy		Max. span; default Kaiser Window		
Min. Signal Duration for 100% POI at the Full-Scale Accuracy		9.3 μ s; 7.82 μ s (Option RSA3000-B25); 7.45 μ s (Option RSA3000-B40)		
Window Type		Hanning, Blackman-Harris, Rectangular, Flattop, Kaiser, Gaussian		
FFT Rate		146,484/s (nom.)		
SFDR		mixer level = -30 dBm		
		<-50 dBc/Hz (typ.)		
Trigger Source		Free Run, External, Power, FMT		
VNA Mode (only available for N models)	Meas Setup			
	Measurement Type	S11, S21, and DTF		
	Measurement Bandwidth	1 kHz to 10 MHz (in 1-3-10 step)		
	Data Points	101 to 10,001; default 201		
	Transmission Measurement S21			
	Trace Format	Lin Mag, Log Mag, Phase, Group Delay		
	Dynamic Range	S21, RBW = 10 kHz, Port1 level = 0 dBm, Log Mag, Average = 50		
		80 dB (nom.)		
	Reflection Measurement S11			
	Trace Format	Lin Mag, Log Mag, Phase, Group Delay, SWR		
Smith Chart (Lin/Phase, Log/Phase, Real/Imag, R+j*X, G+j*B)				
Polar Chart (Lin/Phase, Log/Phase, Real/Imag)				
Corrected Directivity (With CK106A)	S11, Log Mag, Average = 50			
	>40 dB (nom.)			

Order Information

	Description	Order No.
Model	RSA3030 (Real-time Spectrum Analyzer, 9 kHz to 3.0 GHz)	RSA3030
	RSA3045 (Real-time Spectrum Analyzer, 9 kHz to 4.5 GHz)	RSA3045
	RSA3030-TG (Real-time Spectrum Analyzer, 9 kHz to 3.0 GHz, with tracking generator installed before leaving factory)	RSA3030-TG
	RSA3045-TG (Real-time Spectrum Analyzer, 9 kHz to 4.5 GHz, with tracking generator installed before leaving factory)	RSA3045-TG
	RSA3015N (Real-time Spectrum Analyzer, 9 kHz to 1.5 GHz, with tracking generator, VNA supported)	RSA3015N
	RSA3030N (Real-time Spectrum Analyzer, 9 kHz to 3.0 GHz, with tracking generator, VNA supported)	RSA3030N
	RSA3045N (Real-time Spectrum Analyzer, 9 kHz to 4.5 GHz, with tracking generator, VNA supported)	RSA3045N
Standard Accessories	Power Cord Conforming to the Standard of the Destination Country	-

	Description	Order No.
Options	EMI Measurement Application (including RSA3000-EMC)	RSA3000-EMI
	Preamplifier (PA)	RSA3000-PA
	High Stable Clock (Required to be installed and calibrated before leaving factory)	OCXO-C08
	RBW 1 Hz to 10 MHz	RSA3000-BW1
	Real-time Analysis Bandwidth 25 MHz	RSA3000-B25
	Real-time Analysis Bandwidth 40 MHz	RSA3000-B40
	Advanced Measurement Kit	RSA3000-AMK
	EMC Filter and Quasi-Peak Detector Kit	RSA3000-EMC
	Spectrum Analyzer PC Software	Ultra Spectrum
	EMI Pre-compliance Test Software	S1210 EMI Pre-compliance Software

For other optional accessories of the RF instrument, please refer to *RF Accessories Selection Guide*.

RSA3000E Series Spectrum Analyzer

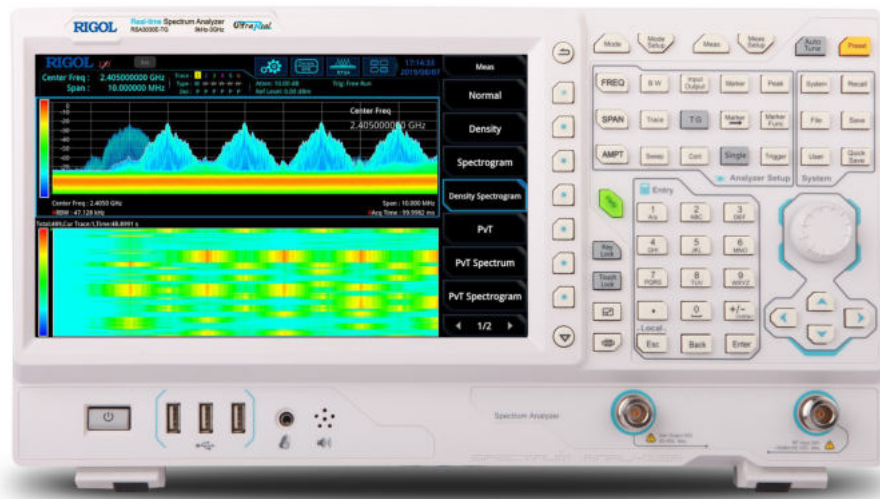

The RSA3000E series real-time spectrum analyzer includes four models; RSA3015E, RSA3015E-TG, RSA3030E, and RSA3030E-TG. The -TG model is equipped with the tracking generator. The frequency band range: 9 kHz to 1.5 GHz; 9 kHz to 3 GHz. The RSA3000E series has a standard configuration of GPSA and RTSA modes, capable of delivering excellent performance at low costs.

The RSA3000E series is a real-time spectrum analyzer built on the Ultra Real technical platform. Both in the GPSA and RTSA working modes, it can deliver excellent specifications. The general-purpose spectrum analyzer may not fully capture the signal due to the deadtime and slow sweep, which may even result in signal loss. Compared with the general-purpose spectrum analyzer, the real-time spectrum analyzer can perfectly address this issue. EMI measurement application software allows users to perform pre-compliance test and diagnosis evaluation before formal EMI certification for the product. The EMI mode enables users to perform EMI pre-compliance test that meets the CISPR standards, help users to identify the EMI compliance problem and ensure that the new design can pass the final certification test at one time.

GPSA is a swept working mode for the general-purpose spectrum analyzer. Compared with DSA800/E and DSA700 series, its key specifications such as phase noise, DANL, RBW, and sweep speed have been greatly enhanced. RTSA is a real-time working mode, which can seamlessly capture the transient signal, and display the measurement results completely through the Density view, Spectrum view, etc. Users can set the FMT trigger mode to accurately capture the desired signal of interest.

- Ultra-Real technology
- Frequency: up to 3 GHz
- Displayed average noise level (DANL): <-161 dBm (typical)
- Phase noise: <-102 dBc/Hz (typical)
- Level measurement uncertainty: <1.0 dB
- 3 GHz tracking generator
- Min. RBW 1 Hz
- Up to 10 MHz real-time analysis bandwidth

- Various measurement functions
- EMI measurement application (opt.)
- Multiple trigger modes and trigger masks
- Density, Spectrogram, and other display modes
- PC software options
- 10.1" capacitive multi-touch screen; supporting touch gestures
- USB, LAN, HDMI and other communication and display interfaces

Conduction/radiation pre-testing with built-in EMI test



Resolution bandwidth as low as 1 Hz

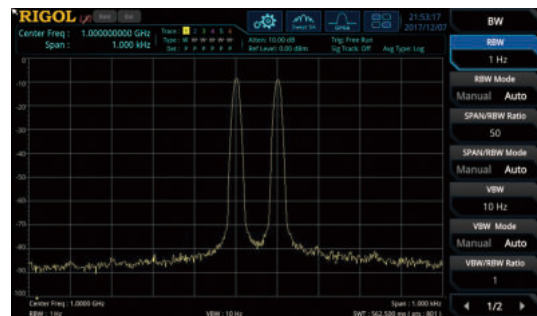

Excellent phase noise reduces the impact on the weak signal testing.

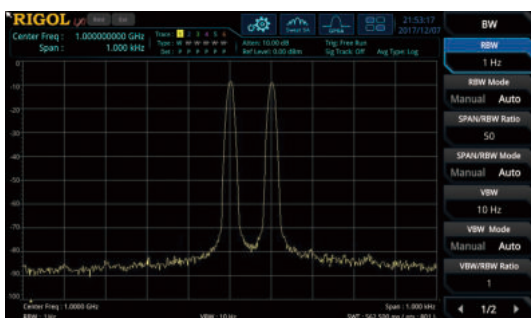

ASK/FSK Demodulation



DANL low as -161 dBm effectively ensures the testing for the weak signals, reducing the impact of the noise floor of the spectrum analyzer.

ASK/FSK demodulation analysis software helps engineers demodulate and analyze signals such as TPMS, PKE/RKE, and obtain parameters of signal modulation quality to accelerate time-to-market for the products.

Excellent phase noise

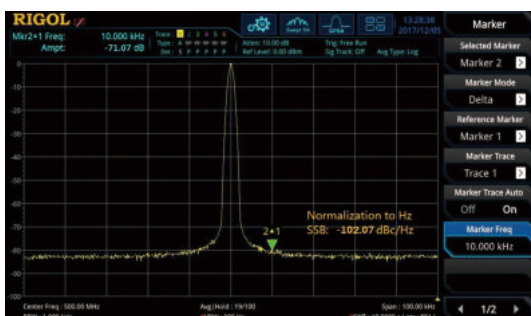

Operate the instrument with gesture-enabled multi-touch screen



Excellent sweep specifications; phase noise low as -102 dBc/Hz.

10.1" capacitive multi-touch screen/gesture-enabled operation allows you to drag, zoom in and out the waveforms.

Models and Specifications

Model		RSA3015E/-TG	RSA3030E/-TG
Frequency Range		9 kHz to 1.5 GHz	9 kHz to 3 GHz
Frequency Stability	0°C to 50°C, with the reference 25°C		
	Standard	<0.5 ppm	
	Option OCXO-C08	<0.005 ppm	
Phase Noise	10 kHz, $f_c = 500$ MHz	<-100 dBc/Hz, <-102 dBc/Hz (typ.)	
Resolution Bandwidth (-3 dB)		1 Hz to 3 MHz, in 1-3-10 step	
Resolution Bandwidth (-6 dB, option)		200 Hz, 9 kHz, 120 kHz, 1 MHz	
Displayed Average Noise Level (DANL)		Preamp on, attenuation = 0 dB, sample detector, trace averages ≥ 50 , tracking generator off, normalized to 1 Hz, 20°C to 30°C, input impedance = 50 Ω . <-158 dBm, <-161 dBm (typ.)	
Level Measurement Uncertainty		<1.0 dB (nom.)	
TG Frequency Range (only available for -TG models)		100 kHz to 1.5 GHz	100 kHz to 3 GHz
TG Output Level Range (only available for -TG models)		-40 dBm to 0 dBm	-40 dBm to 0 dBm
Real-time Analysis Bandwidth		10 MHz (real-time analysis bandwidth not supported)	
Full-scale Accuracy		maximum span; default Kaiser Window	
Min. Signal Duration for 100% POI at the Full-Scale Accuracy		9.3 μ s	
Window Type		Hanning, Blackman-Harris, Rectangular, Flattop, Kaiser, Gaussian	
FFT Rate		146,484/s (nom.)	
SFDR		mixer level = -30 dBm <-50 dBc/Hz (typ.)	
Trigger Source		Free Run, External, Power, FMT	

Order Information

	Description	Order No.
Model	RSA3015E (Real-time Spectrum Analyzer, 9 kHz to 1.5 GHz)	RSA3015E
	RSA3030E (Real-time Spectrum Analyzer, 9 kHz to 3 GHz)	RSA3030E
	RSA3015E-TG (Real-time Spectrum Analyzer, 9 kHz to 1.5 GHz, with tracking generator installed before leaving factory)	RSA3015E-TG
	RSA3030E-TG (Real-time Spectrum Analyzer, 9 kHz to 3 GHz, with tracking generator installed before leaving factory)	RSA3030E-TG

	Description	Order No.
Standard Accessories	Power Cord Conforming to the Standard of the Destination Country	-
Options	EMI Measurement Application (including RSA3000E-EMC)	RSA3000E-EMI
	Preamplifier (PA)	RSA3000E-PA
	High Stable Clock (Required to be installed and calibrated before leaving factory)	OEXO-C08
	Advanced Measurement Kit	RSA3000E-AMK
	EMC Filter and Quasi-Peak Detector Kit	RSA3000E-EMC
	VSWR Measurement Kit	RSA3000E-VSWR
	EMI Pre-compliance Test Software	S1210 EMI Pre-compliance Software
	ASK/FSK Demodulation	RSA3000E-ASK/FSK

NOTE:

For other optional accessories of the RF instrument, please refer to [RF Accessories Selection Guide](#).

DSA800/E Series Spectrum Analyzer



With light weight and compact size, the DSA875, DSA832/E, and DSA815 series spectrum analyzer has excellent technical specifications. Their frequency bands can reach 7.5 GHz, 3.2 GHz, and 1.5 GHz. DSA815 is an entry-level spectrum analyzer, with its frequency range of 9 kHz to 1.5 GHz. It is an economical instrument with an affordable price.

The models of the DSA800/E series are all equipped with the TG option, capable of completing the specification analysis for the RF components. After being installed with the EMI filter and quasi-peak detector options, the instrument can complete the EMI pre-compliance test together with the near-field probe and LISN. With a unique wide screen, novel appearance design, and easy operation experience, the DSA800/E series is an ideal instrument for application scenarios such as the RF R&D, design and verification, production and manufacturing, as well as education training.

- Frequency range: 9 kHz to 7.5 GHz
- Min. RBW 10 Hz
- Min. DANL -161 dBm
- Min. phase noise: -98 dBc/Hz@10 kHz offset
- EMI pre-compliance test
- VSWR measurement
- Signal Seamless Capture (SSC) (available for DSA815)
- Powerful DSA PC control and analysis software

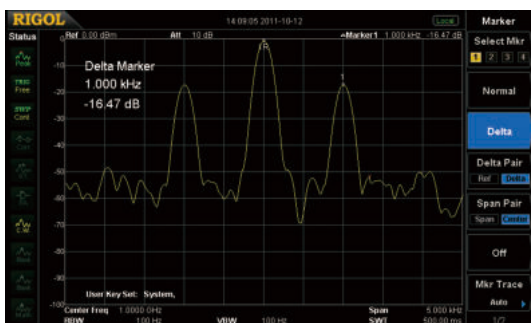

Provide a high RBW of 10 Hz to identify signals with similar frequencies

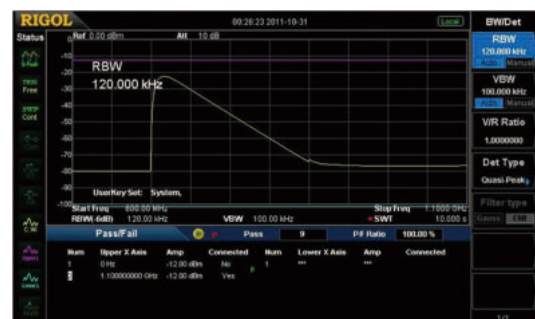

EMI kit (EMI filter & Quasi-peak & Pass/Fail)

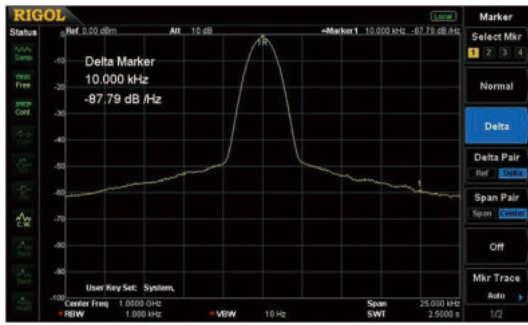

Phase noise < -98 dBc/Hz@10 kHz offset (DSA832/875)

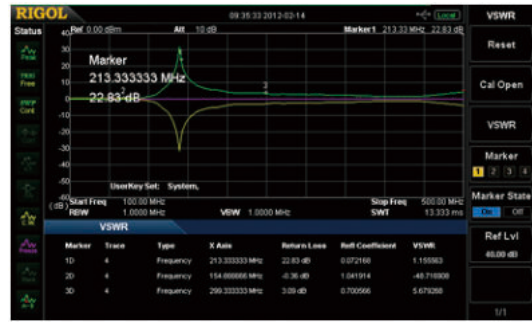

VSWR Measurement kit

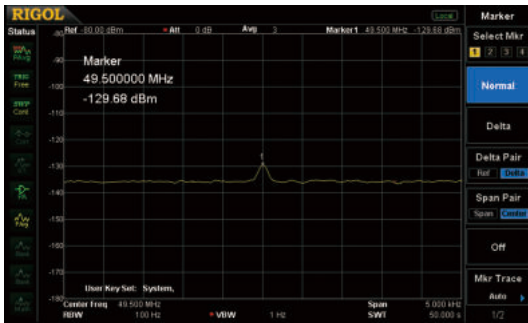

Measure the low-level signals with the PA on

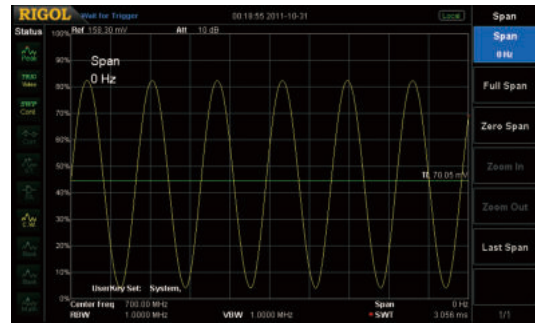

Zero span to demodulate the AM signal

Models and Specifications

	DSA815/-TG	DSA832E/-TG	DSA832/-TG	DSA875/-TG
Frequency Range	9 kHz to 1.5 GHz	9 kHz to 3.2 GHz	9 kHz to 3.2 GHz	9 kHz to 7.5 GHz
Frequency Resolution	1 Hz			
Frequency Reference Aging Rate	<2 ppm/year	<2 ppm/year	<1 ppm/year	
Phase Noise (fc = 1 GHz)	<-80 dBc/Hz@10 kHz offset	<-90 dBc/Hz@10 kHz offset <-98 dBc/Hz@10 kHz offset (typ.)	<-98 dBc/Hz@10 kHz offset	
	<-100 dBc/Hz@100 kHz offset (typ.)	<-100 dBc/Hz@100 kHz offset (typ.)		
Resolution Bandwidth (-3 dB)	10 Hz to 1 MHz; in 1-3-10 step			
Resolution Bandwidth (-6 dB)	200 Hz, 9 kHz, 120 kHz (EMI-DSA800 option)			
Video Bandwidth (-3 dB)	1 Hz to 3 MHz; in 1-3-10 step			
Displayed Average Noise Level (DANL)	PA on, attenuation = 0 dB, RBW = VBW = 100 Hz, sample detector, trace average ≥ 50, TG off, normalized to 1 Hz, 20°C to 30°C, input impedance 50 Ω			
100 kHz to 1 MHz	-130 dBm	<-152 dBm (typ.)	<-152 dBm (typ.)	<-152 dBm (typ.)
	<-150 dBm (typ.)			
1 MHz to 5 MHz	<-150 dBm + 6 x (f/1 GHz) dB	-150 dBm	-152 dBm	-152 dBm
			<-155 dBm (typ.)	

	DSA815/-TG	DSA832E/-TG	DSA832/-TG	DSA875/-TG
5 MHz to 1.5 GHz	<-155 dBm (typ.)	<-155 dBm (typ.)	-157 dBm	-157 dBm
1.5 GHz to 3.2 GHz	-	<-155 dBm	<-161 dBm (typ.)	<-161 dBm (typ.)
		<-161 dBm (typ.)		
3.2 GHz to 6 GHz	-	-	-	<-153 dBm
				<-157 dBm (typ.)
6 GHz to 7.5 GHz	-	-	-	<-148 dBm
				<-152 dBm (typ.)
Detector Type	Normal, positive-peak, negative-peak, sample, RMS, voltage average,quasi-peak (with EMI-DSA800 option)			
Trace Type	Clear write, max hold, min hold, average, view, blank			
Scale Unit	dBm, dBmV, dBμV, nV, μV, mV, V, nW, μW, mW, W			
Level Measurement Uncertainty	<1.5 dB (nom.)	<1.0 dB (nom.)	< 0.8 dB (nom.)	
TG Frequency Range (-TG Model)	100 kHz to 1.5 GHz	100 kHz to 3.2 GHz	100 kHz to 3.2 GHz	100 kHz to 7.5 GHz
TG Output Level Range (-TG Model)	-20 dBm to 0 dBm	-40 dBm to 0 dBm	-40 dBm to 0 dBm	
TG Output Level Resolution (-TG Model)	1 dB			
SSC Measurement Bandwidth	1.5 MHz	N/A		
ASK/FSK Demodulation Analysis (PC Software Option)	-	S1220 ASK-FSK Demodulation Analysis Supported	S1220 ASK-FSK Demodulation Analysis Supported	
I/O	LAN (LXI), USB, and USB-GPIB (option)			

Order Information

	Description	Order No.
Model	DSA815 (Spectrum Analyzer, 9 kHz to 1.5 GHz)	DSA815
	DSA832 (Spectrum Analyzer, 9 kHz to 3.2 GHz)	DSA832
	DSA875 (Spectrum Analyzer, 9 kHz to 7.5 GHz)	DSA875
	DSA832E (Spectrum Analyzer, 9 kHz to 3.2 GHz)	DSA832E
	DSA815-TG (Spectrum Analyzer, 9 kHz to 1.5 GHz, with TG installed when leaving the factory)	DSA815-TG
	DSA832-TG (Spectrum Analyzer, 9 kHz to 3.2 GHz, with TG installed when leaving the factory)	DSA832-TG
	DSA875-TG (Spectrum Analyzer, 9 kHz to 7.5 GHz, with TG installed when leaving the factory)	DSA875-TG
	DSA832E-TG (Spectrum Analyzer, 9 kHz to 3.2 GHz, with TG installed when leaving the factory)	DSA832E-TG
Standard Accessories	Power Cord Conforming to the Standard of the Destination Country	-

	Description	Order No.
Options	EMI Filter and Quasi-Peak Detector Kit	EMI-DSA800
	Advanced Measurement	AMK-DSA800
	VSWR Measurement Kit	VSWR-DSA800
	DSA PC Software	Ultra Spectrum
	Signal Seamless Capture(Only Available for DSA815 and DSA700)	SSC-DSA
	EMI Pre-compliance Test Software	S1210 EMI Pre-compliance Software
	ASK-FSK Demodulation Analysis (Only Available for DSA832/DSA875/ DSA832E)	S1220 ASK-FSK Demodulation Analysis Software

NOTE:

For other optional accessories of the RF instrument, please refer to [RF Accessories Selection Guide](#).

DSA700 Series Spectrum Analyzer

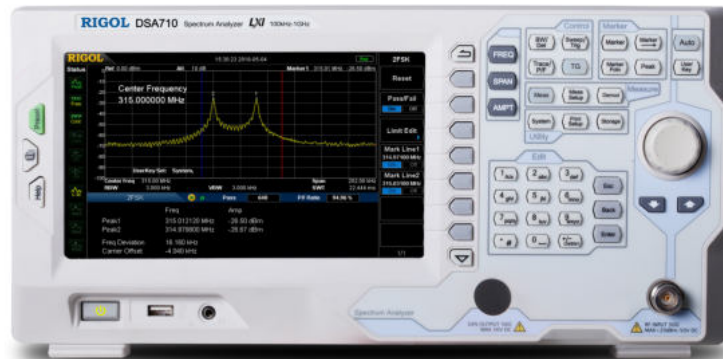

With a compact size and light weight, the DSA700 series spectrum analyzer has an excellent technical specification. Its measurement frequency range is from 100 kHz to 1 GHz. The high cost-effective spectrum analyzer with a high performance makes it popular with the users.

After being installed with the EMI filter and quasi-peak detector, the DSA700 series can complete the EMI pre-compliance test together with the near-field probe and LISN. With the SSC-DSA option, the DSA700 series is capable of capturing signals seamlessly. With a unique wide screen, novel appearance design, and easy operation experience, the DSA700 series is an ideal instrument for application scenarios such as the RF R&D, design and verification, production and manufacturing, as well as education training.

- Frequency range: 100 kHz to 1 GHz
- Min. RBW 100 Hz
- Min. DANL -130 dBm
- Min. Phase noise: -80 dBc/Hz@10 kHz offset
- EMI pre-compliance test
- Signal Seamless Capture (SSC)
- Powerful DSA PC control and analysis software

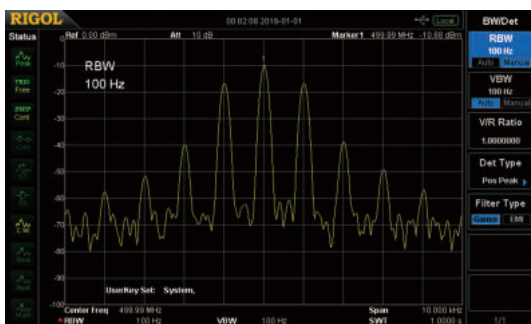

Provide a high RBW of 100 Hz to identify signals with similar frequencies

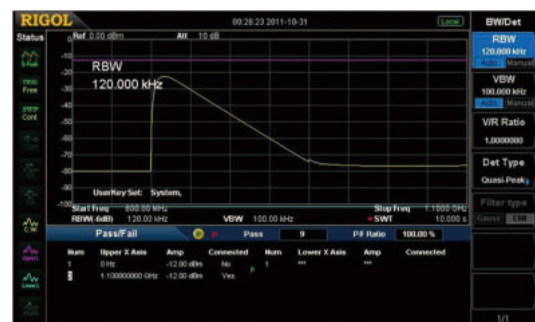

EMI kit (EMI filter & Quasi-peak & Pass/Fail)

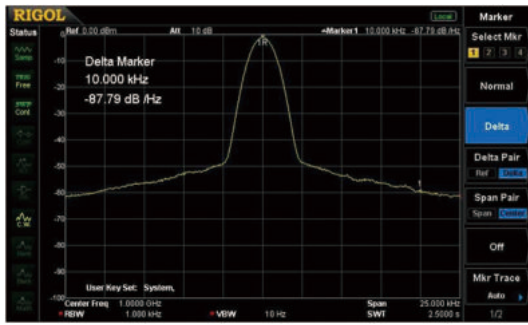

Phase noise < -80 dBc/Hz@10 kHz offset

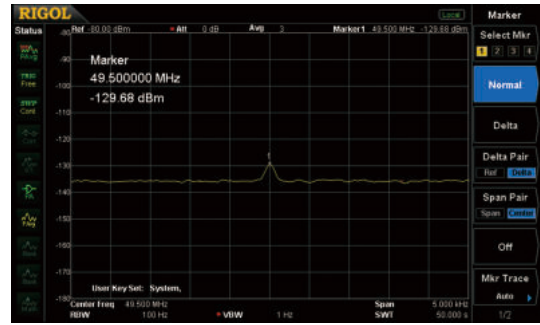

Measure the low-level signals with the PA on

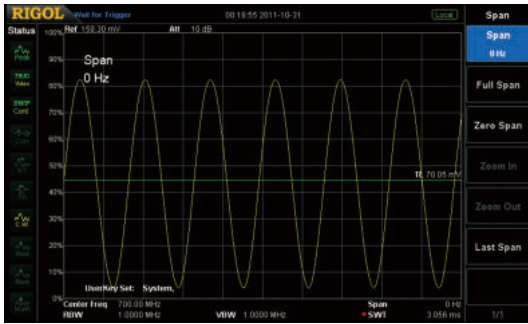

Zero span to demodulate the AM signal

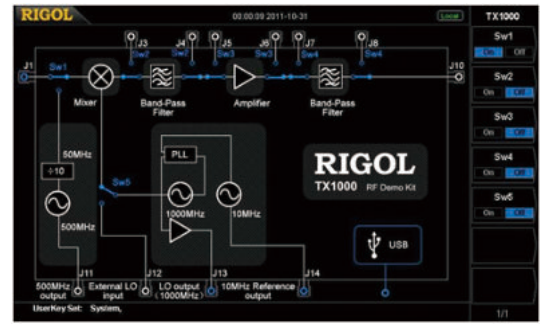

Built-in TX1000 panel control

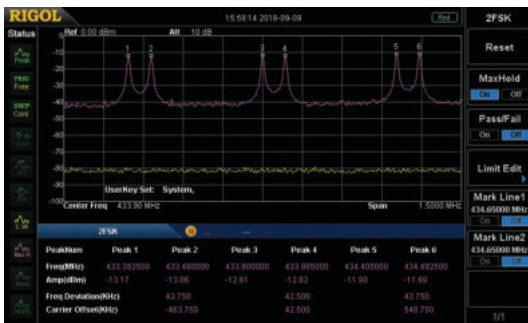

Capture FSK signal with the SSC kit

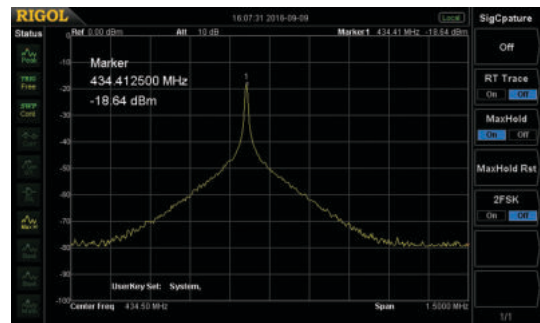

Capture ASK signal with the SSC kit

Models and Specifications

	DSA705	DSA710
Frequency Range	100 kHz to 500 MHz	100 kHz to 1 GHz
Frequency Resolution	1 Hz	
Aging Rate	<2 ppm/year	
Phase Noise (fc = 1 GHz)	<-80 dBc/HZ@10kHz offset	
Resolution Bandwidth (-3 dB)	100 Hz to 1 MHz; in 1-3-10 step	
Resolution Bandwidth (-6 dB)	200 Hz, 9 kHz, and 120 kHz (EMI-DSA800 Option)	
Video Bandwidth (-3 dB)	1 Hz to 3 MHz; in 1-3-10 step	
Maximum Input DC Voltage	50 V	

	DSA705	DSA710
Maximum Input CW RF Power	attenuation = 30 dB, +20 dBm (100 mW)	
Maximum Damage Level	+30 dBm (1 W)	
Displayed Average Noise Level (DANL)	PA ON, RBW = VBW = 100 Hz, sample detector, trace average \geq 50	
100 kHz to 1 MHz	<-110 dBm, <-130 dBm (typ.)	
1 MHz to 500 MHz	<-120 dBm, <-130 dBm (typ.)	
500 MHz to 1 GHz	-	<-120 dBm, <-130 dBm (typ.)
Detector Type	Normal, positive-peak, negative-peak, sample, RMS, voltage average,quasi-peak (with EMI-DSA800 option)	
Trace Function	Clear write, max hold, min hold, average, view, blank	
Scale Unit	dBm, dBmV, dB μ V, nV, μ V, mV, V, nW, μ W, mW, W	
Level Measurement Uncertainty	<1.5 dB (nom.)	
SSC Measurement Bandwidth	1.5 MHz	
I/O	LAN (LXI), USB, USB-GPIB (option)	

Order Information

	Description	Order No.
Model	DSA705 (Spectrum Analyzer, 100 kHz to 500 MHz, with the PA)	DSA705
	DSA710 (Spectrum Analyzer, 100 kHz to 500 MHz, with the PA)	DSA710
Standard Accessories	Power Cord Conforming to the Standard of the Destination Country	-
Options	EMI Filter and Quasi-Peak Detector Kit	EMI-DSA800
	Advanced Measurement Kit	AMK-DSA800
	DSA PC Software	Ultra Spectrum
	Signal Seamless Capture	SSC-DSA

NOTE:

For other optional accessories of the RF instrument, please refer to [RF Accessories Selection Guide](#).

EMI Test System

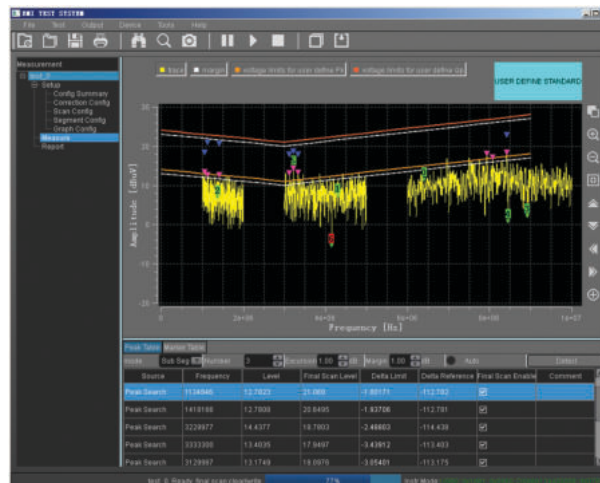

EMI test system is a PC application software developed by RIGOL for RSA5000, RSA3000/E, DSA800, DSA800E and DSA700 series with the EMI-DSA800 option to do the EMI pre-compliance tests. You can perform conduction and radiation tests by using the TMI Test System^[1]S1210 EMP Pre-compliance software and RIGOL's RSA/DSA series spectrum analyzers. You can measure the interference voltage on the power cable by using the linear impedance stability network (LISN) and perform amplitude correction on the results by loading the correction factor (preamplifier, attenuator, antenna, cable, or correction array) automatically to the radiation test.

This software also provides various functions to facilitate your measurements. You can set various parameters (such as the frequency range, resolution bandwidth, and scan time) via the scan table. After performing a scan, the results can be displayed in log or linear format. You can search for signal peak value and view the results displayed in the peak table. Besides, you can mark and delete the undesired signal, as well as easily recognize signals that do not pass the standard limit line. The software also supports the marker table. In the marker table, you can double click the table to add a marker to mark any frequency point that interests you.

- Provide amplitude correction
- Segment scanning and editing for the table to accelerate the measurement
- Limit line function helps quickly judge the measurement results
- Provide fast pre-scan and final scan modes
- Provide peak search function, define and save the peak table
- Frequency axis displayed in linear or log format
- Amplitude axis displayed in multiple amplitude units
- Generate test report automatically

Note:^[1] Use the built-in EMI function of the RSA series.

Recommended Configuration

	Description	Order No.
Model	RSA5000/3000/3000E, DSA800/800E/700 Series Spectrum Analyzer	Refer to Specific Models of Each Series
	EMI Filter and Quasi-Peak Detector of the RSA3000 Series Spectrum Analyzer	RSA3000-EMC
	EMI Filter and Quasi-Peak Detector of the RSA3000E Series Spectrum Analyzer	RSA3000E-EMC
	EMI Filter and Quasi-Peak Detector Kit of the DSA800/800E/700 Series	EMI-DSA800
EMI Pre-compliance Test Analysis Software	EMI Test System	S1210
Test Accessories	Near-Field Probe (For Detecting the Near-field Radiated EMI Emissions Testing)	NFP-3
	Line Impedance Stabilization Network (LISN) (For Conducted EMI Testing)	Self-provided
	Antenna (For Far-field Radiated EMI Emissions Testing)	Self-provided

NFP-3 Near-field Probe

NFP-3 is used with RIGOL RSA/DSA series spectrum analyzer for the EMI tests of electronic products. It can be used to test the magnetic field strength and magnetic field coupling channels on the surface of the electronic components as well as the magnetic field environment near the electronic module so as to quickly locate the interference source. NFP-3 includes four models (NFP-3-P1, NFP-3-P2, NFP-3-P3 and NFP-3-P4).

Test Connection

The test connection between the NFP-3 and the spectrum analyzer is shown in the following figure.



- **Connect the spectrum analyzer**

Connect the SMB (M) terminal of NFP-3 and the BNC (F) terminal of the N-BNC adaptor respectively by using the BNC-SMB RF cable. Then connect the N (M) terminal of the N-BNC adaptor to the RF input terminal of the spectrum analyzer.

- **Connect the device under test**

NFP-3 is used to perform short-distance contact-free measurement on the device under test. Pay attention to the direction where the probe is positioned during measurement.

- **Typical Applications**

Locate the EMI radiation interference source.

Determine the frequency and relative strength of the spectral component of the interference source.

Specifications

Frequency	
Frequency Range	30 MHz to 3 GHz

Terminal Type	
Terminal Type	SMB(M)
Adaptor	N(M)-BNC(F)

Terminal Type	
RF Cable	BNC(M)-SMB(F), 1,000 mm
Terminal and Adaptor Impedance	50 Ω

Common RF Accessories



DSA Utility Kit



RF CATV Kit



30 dB High Power Attenuator



RF Adapter Kit



RF Attenuator Kit



VSWR Bridge



CK106A



CK106E



RF Cable

RF Accessories Selection Guide

Option	Description	RSA5065/-TG/N	RSA5032/-TG/N	RSA3030/-TG/N	RSA3045/-TG/N	RSA3015N	RSA3030E/-TG	RSA3015E/-TG	RSA875/-TG	RSA832/-TG	RSA832E/-TG	RSA815/-TG	RSA710	RSA705
RSA5000-AMK	Advanced Measurement Kit, including T-Power, ACP (Adjacent Channel Power), ChanPwr (Channel Power), OBW (Occupied Bandwidth), EBW (Emission Bandwidth), C/N Ratio, HarmoDist (Harmonic Distortion), and TOI (Third Order Intermodulation)	○	○											
RSA3000-AMK	Advanced Measurement Kit, including T-Power, ACP (Adjacent Channel Power), ChanPwr (Channel Power), OBW (Occupied Bandwidth), EBW (Emission Bandwidth), C/N Ratio, HarmoDist (Harmonic Distortion), TOI (Third Order Intermodulation), and Pass/Fail test			○	○	○								
RSA3000E-AMK	Advanced Measurement Kit, including T-Power, ACP (Adjacent Channel Power), ChanPwr (Channel Power), OBW (Occupied Bandwidth), EBW (Emission Bandwidth), C/N Ratio, HarmoDist (Harmonic Distortion), TOI (Third Order Intermodulation), and Pass/Fail test						○	○						
AMK-DSA800	Advanced Measurement Kit, including T-Power, ACP (Adjacent Channel Power), ChanPwr (Channel Power), OBW (Occupied Bandwidth), EBW (Emission Bandwidth), C/N Ratio, HarmoDist (Harmonic Distortion), and TOI (Third Order Intermodulation)								○	○	○	○	○	○
RSA5000-VSA	Vector Signal Analysis Measurement Application	○	○											
RSA5000-EMC	EMI Filter and Quasi-Peak Detector Kit	●	●											
RSA3000-EMC	EMI Filter and Quasi-Peak Detector Kit			○	○	○								
RSA3000E-EMC	EMI Filter and Quasi-Peak Detector Kit						○	○						
RSA5000-EMI	EMI Measurement Application	○	○											
RSA3000-EMI	EMI Measurement Application (including RSA3000-EMC)			○	○	○								
RSA3000E-EMI	EMI Measurement Application (including RSA3000E-EMC)						○	○						
EMI-DSA800	EMI Filter and Quasi-Peak Detector Kit								○	○	○	○	○	○
RSA5000-VSWR	VSWR Measurement Kit for the -TG Model, providing measurement results such as test wizard, return loss, reflection coefficient and VSWR (required to work with VSWR bridge)	●	●											

Option	Description	RSA5065/-TG/N	RSA5032/-TG/N	RSA3030/-TG/N	RSA3045/-TG/N	RSA3015N	RSA3030E/-TG	RSA3015E/-TG	RSA875/-TG	RSA832/-TG	RSA832E/-TG	RSA815/-TG	RSA710	RSA705
RSA3000-VSWR	VSWR Measurement Kit for the -TG Model, providing measurement results such as test wizard, return loss, reflection coefficient and VSWR (required to work with VSWR bridge)			•	•	•								
VSWR-DSA800	VSWR Measurement Kit for the -TG Model, providing measurement results such as test wizard, return loss, reflection coefficient and VSWR (required to work with VSWR bridge)								○	○	○	○		
S1210	EMI test PC software for EMI Pre-Compliance testing	○	○	○	○	○	○	○	○	○	○	○	○	○
Ultra Spectrum	DSA PC software	○	○	○	○	○	○	○	○	○	○	○	○	○
RSA3000E-ASK/FSK	ASK/FSK Demodulation						○	○						
S1220	ASK/FSK Demodulation								○	○	○			
SSC-DSA	Signal Seamless Capture	•	•	•	•	•	•	•				○	○	○
RSA5000-PA	Preamplifier, Available for RSA5000	○	○											
RSA3000-PA	Preamplifier, Available for RSA3000			○	○	○								
RSA3000E-PA	Preamplifier, Available for RSA3000E						○	○						
PA-DSA800	Preamplifier (PA)								•	•	•	•	•	•
RSA5000-B40	Real-time Analysis Bandwidth 40 MHz	○	○											
RSA3000-B25	Real-time Analysis Bandwidth 25 MHz (Not available for -E model)			○	○	○								
RSA3000-B40	Real-time Analysis Bandwidth 40 MHz (Not available for -E model)			○	○	○								
OCXO-C08	High Stable Clock (Required to be installed and calibrated before leaving factory)	○	○	○	○	○	○	○						
NFP-3	Near-Field Probe x4, 30 MHz to 3 GHz	○	○	○	○	○	○	○	○	○	○	○	○	○
DSA Utility Kit	Includes: N-SMA Cable, BNC-BNC Cable, N-BNC Adaptor, N-SMA Adaptor, 75 Ω-50 Ω Adaptor, Antenna x2 (900 MHz/1.8 Ghz), Antenna x 2 (2.4 GHz)	○	○	○	○	○	○	○	○	○	○	○	○	○
RF Adaptor Kit	Includes: N(F)-N(F) adaptor x1, N(M)-N(M) adaptor x1, N(M)-SMA(F) adaptor x2, N(M)-BNC(F) adaptor x2, SMA(F)-SMA(F) adaptor x1, SMA(M)-SMA(M) adaptor x1, BNC T-type adaptor x1, 50 Ω SMA load x1, 50 Ω BNC impedance adaptor x1	○	○	○	○	○	○	○	○	○	○	○	○	○
RF CATV Kit	Includes: 50 Ω-75 Ω Adaptor x2	○	○	○	○	○	○	○	○	○	○	○	○	○
RF Attenuator Kit	Includes: 6 dB Attenuator x1, 10 dB Attenuator x2	○	○	○	○	○	○	○	○	○	○	○	○	○
ATT03301H	30 dB High-Power Attenuator, with the Max. Power of 100 W	○	○	○	○	○	○	○	○	○	○	○	○	○

Option	Description	RSA5065/-TG/N	RSA5032/-TG/N	RSA3030/-TG/N	RSA3045/-TG/N	RSA3015N	RSA3030E/-TG	RSA3015E/-TG	RSA875/-TG	RSA832/-TG	RSA832E/-TG	RSA815/-TG	RSA710	RSA705
CB-NM-NM-75-L-12G	N(M)-N(M) RF Cable, Up to 12.4 GHz	○	○	○	○	○	○	○	○	○	○	○	○	○
CB-NM-SMAM-75-L-12G	N(M)-SMA(M) RF Cable, Up to 12.4 GHz	○	○	○	○	○	○	○	○	○	○	○	○	○
TX1000	RF Demo Kit (Transmitter)								○	○	○	○	○	○
VB1032 ^[1] Only available for the -TG model	VSWR Bridge, 1 MHz to 3.2 GHz	○	○	○	○	○	○	○	○	○	○	○		
VB1040 ^[1] Only available for the -TG model	VSWR Bridge, 800 MHz to 4 GHz	○	○	○	○	○	○	○	○	○	○	○		
VB1080 ^[1] Only available for the -TG model	VSWR Bridge, 2 GHz to 8 GHz	○	○	○	○	○	○	○	○	○	○	○		
RM6041	Rack Mount Kit (Available for the RSA Series)	○	○	○	○	○	○	○						
RM-DSA800	Rack Mount Kit (Available for the DSA800 and DSA700 Series)								○	○	○	○	○	○
USB-GPIB	USB-GPIB Adaptor								○	○	○	○	○	○
BAG-G1	Carrying Bag (Available for the DSA800 Series)								○	○	○	○	○	○
CK106A&CK106E	High-performance Network Analysis Calibration Kit (Only Available for -N Model)	○	○	○	○	○								

● Standard ○ Option

[1] VSWR-DSA800 provided for free

RF Signal Generator



RIGOL RF signal generators adopt an innovative design, breaking through the cost bottleneck of traditional products, providing users with unprecedented cost-effective products. DSG series signal generators can provide highly pure RF signals, and the typical value of phase noise can be as low as -133 dBc/Hz. The application of digital ALC circuit enables accurate control of the amplitude of output RF signals, with power accuracy up to 0.5 dB. In addition to the conventional AM/FM/ΦM modulation, the RF signal generator can also provide pulse modulation and pulse train functions to meet the communication and research requirements. DSG800A model also offers a variety of I/Q modulations, supporting internal or external modulation and providing IF signal output.

The convenient operation and abundant functions make DSG series RF signal generators become the ideal instrument for the development and design of wireless communication, Internet of things (IoT) and consumer electronic products. They provide cost-effective test solutions for the production and testing of RF components. The economical DSG800 series sets a new benchmark for RF testing instruments, making it affordable for engineers engaged in college teaching experiments and basic RF development. The DSG3000B series is a high-performance RF signal generator. It is an ideal tool in various fields such as communication, computers, instrumentation, R&D, education, production and maintenance.

Model	Frequency Band							
	1.5	2.1	3	3.6	6.5	12	13.6	20
DSG815	√							
DSG830			√					
DSG821		√						
DSG821A		√						
DSG836				√				
DSG836A				√				
DSG3065B					√			
DSG3065B-IQ					√			
DSG3136B							√	
DSG3136B-IQ							√	
DSG5122/DSG5124/DSG5126/DSG5128						√		
DSG5202/DSG5204/DSG5206/DSG5208								√

Model	Amplitude Range	Amplitude Accuracy	Clock Stability	Phase Noise	Std. Modulations	Pulse Train Generator	IQ Mod.
DSG815	-110 dBm to +13 dBm	≤0.5 dB (typ.)	<2 ppm <5 ppb (opt.)	-112 dBc/Hz@1 GHz, 20 kHz offset (typ.)	AM/FM/ØM	DSG800-PUM DSG800-PUG (including DSG800-PUM)	-
DSG830							-
DSG821							-
DSG821A							Std.
DSG836							-
DSG836A							Std.
DSG3065B	-110 dBm to +27 dBm	≤0.5 dB (typ.)	<1 ppm <5 ppb (opt.)	-116 dBc/Hz@1 GHz, 20 kHz offset (typ.)	AM/FM/ØM	DSG3000B-PUG	-
DSG3065B-IQ							Std.
DSG3136B							-
DSG3136B-IQ							Std.
DSG5122/DSG5124/ DSG5126/DSG5128	-30 dBm to +25 dBm	<0.7 dB (typ.)	<0.5 ppm <5 ppb (opt.)	-133 dBc/Hz@1 GHz, 10 kHz offset (typ.)	AM/FM/ØM/ Pulse	DSG5000-PUG	-
DSG5202/DSG5204/ DSG5206/DSG5208							-

DSG5000 Series Microwave Signal Generator



DSG5000 series microwave signal generator is a multi-channel phase-coded microwave signal generator with the frequency up to 20 GHz, the output level range from -30 dBm to +25 dBm. The DSG5000 series includes models with 2, 4, 6, or 8 channels. With its high channel-to-channel phase stability, it can meet customers' demand for the application of the multi-channel coherent signals. The DSG5000 series has low phase noise and excellent spurious specifications. Besides the high stability clock (OCXO) option, it is equipped with AM, FM, PM, and Pulse modulation functions, which can be widely used in R&D, production, maintenance, education and training scenarios.

The DSG5000 series is equipped with the Android-based system. There are no physical keys except the power key button. The instrument can be controlled by the touch screen, the externally connected mouse, Web Control, and SCPI commands. The user-friendly operation mode has greatly improved the user experience. Besides the touch screen, the DSG5000 series also allows you to connect an external display via the HDMI interface.

- Frequency range: 9 kHz to 20 GHz
- Frequency resolution: 0.01 Hz
- Output level setting range: -30 dBm to +25 dBm
- Amplitude resolution: 0.01 dB
- Phase noise: -133 dBc/Hz@10 kHz, carrier waveform 1 GHz (typ.)
- Full-scale accuracy: <0.7 dB (typ.)
- Switchover time < 3 ms (typ.)
- Channel-to-channel phase stability: <1°@10 GHz
- Channel-to-channel isolation: > 80 dB (typ.)
- Harmonics spurious: <-50 dBc@10 GHz
- Modulation type: AM, FM, PM, and Pulse
- Communication interface: USB and LAN
- Number of channels: 2, 4, 6, and 8
- Structure dimensions: 2U height, full-rack width

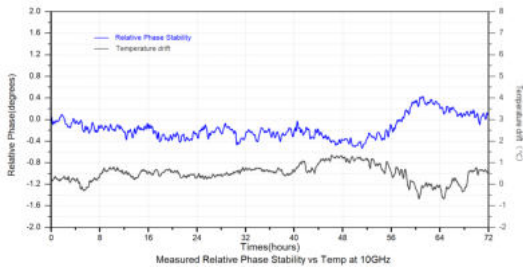

Superb long-term phase stability

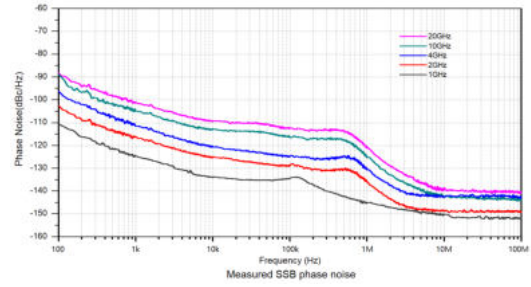

Low phase noise

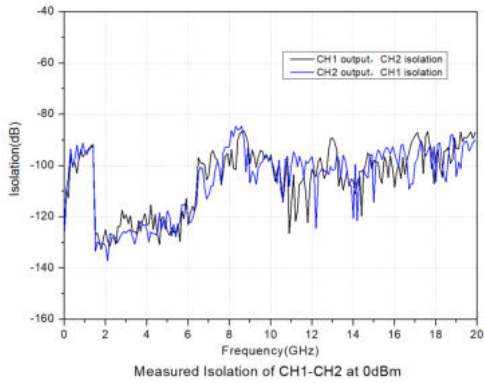

Channel-to-channel isolation

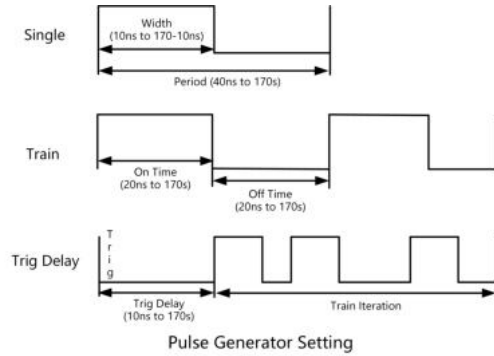

Pulse modulation; on/off ratio up to 80 dB

Multiple modulations

Simultaneous Modulation				
	Amplitude Modulation	Frequency Modulation	Phase Modulation	Pulse Modulation
Amplitude Modulation	-	○	○	△
Frequency Modulation	○	-	×	○
Phase Modulation	○	×	-	○
Pulse Modulation	△	○	○	-

NOTE:

○: compatible; ×: incompatible; △: compatible, but the AM performance will be undermined when pulse modulation is enabled.

Models and Specifications

Model	DSG5122/DSG5124/DSG5126/DSG5128	DSG5202/DSG5204/DSG5206/DSG5208
Frequency Range	9 kHz to 12 GHz	9 kHz to 20 GHz
Amplitude Setting Range	-30 dBm to +25 dBm	

Model		DSG5122/DSG5124/DSG5126/DSG5128	DSG5202/DSG5204/DSG5206/DSG5208
Amplitude Resolution		0.01 dB	
Clock Reference Stability		<0.5 ppm <5 ppb(With option OCXO-D08)	
Spectral Purity	SSB Phase Noise	CW mode, level > -10 dBm, carrier offset = 10 kHz, 1 Hz measurement bandwidth f = 1 GHz: <-130 dBc/Hz, <-133 dBc/Hz (typ.) f = 2 GHz: <-120 dBc/Hz, <-123 dBc/Hz (typ.) f = 4 GHz: <-114 dBc/Hz, <-117 dBc/Hz (typ.) f = 10 GHz: <-108 dBc/Hz, <-111 dBc/Hz (typ.) f = 20 GHz: <-102 dBc/Hz, <-105 dBc/Hz (typ.)	
	Harmonic Distortion	CW mode <-30 dBc (10 MHz < f ≤ 4 GHz, level ≤ +10 dBm) <-50 dBc (4 GHz < f ≤ 10 GHz, level ≤ +10 dBm) <-30 dBc (10 GHz < f ≤ 20 GHz, level ≤ +7 dBm)	
	Non-harmonic Distortion	CW mode, level > -10 dBm, carrier offset > 10 kHz 1 MHz ≤ f ≤ 1.5 GHz: <-60 dBc, <-70 dBc (typ.) 1.5 GHz ≤ f ≤ 2.825 GHz: <-70 dBc, <-75 dBc (typ.) 2.825 GHz ≤ f ≤ 5.65 GHz: <-64 dBc, <-69 dBc (typ.) 5.65 GHz < f ≤ 11.3 GHz: <-58 dBc, <-63 dBc (typ.) 11.3 GHz < f ≤ 20 GHz: <-52 dBc, <-57 dBc (typ.)	
Sweep	Sweep Mode	Step/List sweep; Single/Continuous sweep	
	Sweep Points	2 to 1,001	
Modulation Type		AM, FM, PM, and pulse modulation	
AM	Modulation Depth	0% to 100%	
	Setting Uncertainty	<4% of setting + 1%	
	Modulation Frequency Response	<3 dB (m < 80%, DC/10 Hz to 100 kHz)	
FM	Max. Deviation	N ^[1] x 2 MHz	
	Setting Uncertainty	< 2% of setting + +20 Hz	
	Modulation Frequency Response	<3 dB (10 Hz to 100 kHz)	
PM	Max. Deviation	N ^[1] x 5 rad	
	Setting Uncertainty	<1% of setting + 0.1 rad	
	Modulation Frequency Response	<3 dB (DC/10 Hz to 100 kHz)	

Model		DSG5122/DSG5124/DSG5126/DSG5128	DSG5202/DSG5204/DSG5206/DSG5208
Pulse Modulation	On/Off Ratio	>80 dB (typ.) ($f \leq 6$ GHz)	
		>70 dB (typ.) $6 \text{ GHz} < f \leq 11 \text{ GHz}$	
		>60 dB (typ.) ($f > 11$ GHz)	
	Rise/Fall Time	<50 ns, 20 ns (typ.)	
	Operating Mode	Single pulse, pulse train (option DSG5000-PUG)	
General Specifications	I/O	Standard: USB, LAN, and HDMI	
		Front panel: RF output, external trigger input [TRIGGER], signal valid output [VALID], pulse input/output [PULSE], and sweep output [SWEEP]	
		Rear panel: external modulation input [EXT MOD IN], external reference clock [10MHz IN/OUT], Sync reference clock output [4.8GHz OUT/IN]	

NOTE:

[1]: $9 \text{ kHz} \leq f \leq 1.5 \text{ GHz}$, $N = 1$; $1.5 \text{ GHz} \leq f < 2.825 \text{ GHz}$, $N = 0.25$; $2.825 \text{ GHz} < f \leq 5.65 \text{ GHz}$, $N = 0.5$; $5.65 \text{ GHz} \leq f < 11.3 \text{ GHz}$, $N = 1$; $11.3 \text{ GHz} < f \leq 20 \text{ GHz}$, $N=2$.

Order Information

	Description	Order No.
Model	DSG5122 (2CH Microwave Signal Generator, 9 kHz to 12 GHz)	DSG5122
	DSG5124 (4CH Microwave Signal Generator, 9 kHz to 12 GHz)	DSG5124
	DSG5126 (6CH Microwave Signal Generator, 9 kHz to 12 GHz)	DSG5126
	DSG5128 (8CH Microwave Signal Generator, 9 kHz to 12 GHz)	DSG5128
	DSG5202 (2CH Microwave Signal Generator, 9 kHz to 20 GHz)	DSG5202
	DSG5204 (4CH Microwave Signal Generator, 9 kHz to 20 GHz)	DSG5204
	DSG5206 (6CH Microwave Signal Generator, 9 kHz to 20 GHz)	DSG5206
	DSG5208 (8CH Microwave Signal Generator, 9 kHz to 20 GHz)	DSG5208
Standard Accessories	Power Cord Conforming to the Standard of the Destination Country	-
Options	Pulse Modulation	DSG5000-PUL
	Pulse Train Generator	DSG5000-PUG
	Analog Modulation	DSG5000-AMD
	High Stability Clock (OCXO)	OCXO-D08
	Rack Mount Kit	RM2031



NOTE:

For all the mainframes, accessories, and options, please contact the local office of RIGOL.

DSG3000B Series RF Signal Generator



DSG3000B series is a high-performance RF signal generator. It provides comprehensive modulation solutions: AM/FM/ΦM analog modulation; pulse modulation with customized pulse train and I/Q modulation. All modulations support internal and external modulation sources. In addition, to meet the demands of production environments, the DSG3000B series has undergone a strict verification through the experiments in its design and production stages to ensure its high stability and reliability. The DSG3000B series also features a clear user interface, compact size and light weight. It is easy to operate and can output stable, precise and pure signals. It is an ideal tool in various fields such as communication, computers, instrumentation, R&D, education, production and maintenance.

- Frequency up to 6.5 GHz/13.6 GHz
- Amplitude accuracy <0.5 dB
- Output level setting range: -130 dBm to +27 dBm
- High signal purity, with the phase noise <-116 dBc/Hz@20 kHz
- Standard 1 ppm internal clock; optional 5 ppb high stable clock
- Standard AM/FM/ΦM analog modulation
- Pulse modulation; on/off ratio up to 70 dB
- User-defined pulse train
- I/Q modulation and I/Q baseband output
- All modulations support internal and external modulation sources
- Standard 2U height design to save rack space; rack mount kit available
- USB/LAN/GPIB remote control interfaces for connectivity; SCPI command set for remote control
- Wear-free electronic attenuator design

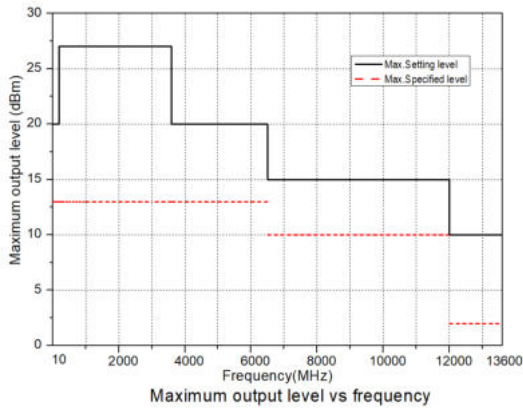

Maximum output level vs frequency

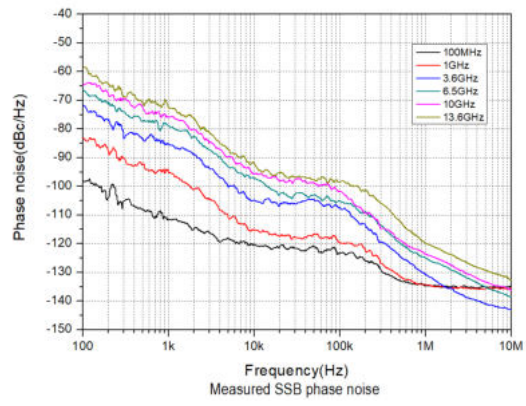

Excellent phase noise

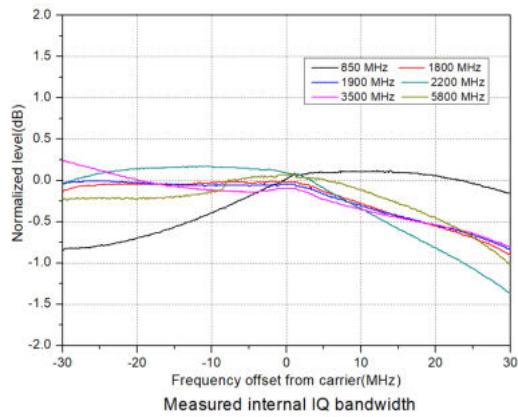

Support internal and external IQ modulation

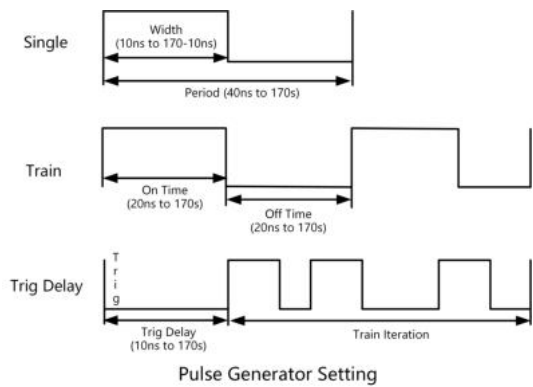

Pulse modulation; on/off ratio up to 70 dB

Multiple modulation methods

Simultaneous Modulation					
	Amplitude Modulation	Frequency Modulation	Phase Modulation	Pulse Modulation (Opt.)	I/Q Modulation (Opt.)
AM	-	○	○	△	×
FM	○	-	×	○	○
ΦM	○	×	-	○	○
Pulse Modulation (Opt.)	△	○	○	-	○
I/Q Modulation (Opt.)	×	○	○	○	-

NOTE:

○: compatible; ×: incompatible; △: compatible, but the AM performance will be undermined when pulse modulation is enabled.

Models and Specifications

Model		DSG3065B	DSG3065B-IQ	DSG3136B	DSG3136B-IQ
Frequency Range		9 kHz to 6.5 GHz	9 kHz to 6.5 GHz (IQ: 50 MHz to 6.5 GHz)	9 kHz to 13.6 GHz	9 kHz to 13.6 GHz (IQ: 50 MHz to 6.5 GHz)
Amplitude Range		-110 dBm to +13 dBm			
Amplitude Setting Range		-130 dBm to +27 dBm			
Amplitude Accuracy		<0.9 dB (<0.5 dB, typ.)			
Clock Reference Stability		<1 ppm <5 ppb(With option OCXO-B08)			
Spectral Purity	SSB Phase Noise	CW mode, carrier offset = 20 kHz, 1 Hz measurement bandwidth f = 1 GHz: <-110 dBc/Hz, <-116 dBc/Hz (typ.) f = 6.5 GHz: <-98 dBc/Hz, <-102 dBc/Hz (typ.) f = 13.6 GHz: <-92 dBc/Hz, <-96 dBc/Hz (typ.)			
	Harmonic Distortion	CW mode <-30 dBc (2 MHz < f ≤ 6.5GHz, level ≤ +13 dBm) <-30 dBc (6.5 GHz < f ≤ 12 GHz, level ≤ +10 dBm) <-30 dBc (12 GHz < f ≤ 13.6 GHz, level ≤ 2 dBm)			
	Non-harmonic Distortion	CW mode, level > -10 dBm, carrier offset > 10 kHz 100 kHz ≤ f ≤ 1.5 GHz: <-60 dBc, <-70 dBc (typ.) 1.5 GHz ≤ f ≤ 3.6 GHz: <-54 dBc, <-64 dBc (typ.) 3.6 GHz ≤ f ≤ 6.5 GHz: <-48 dBc, <-58 dBc (typ.) 6.5 GHz < f ≤ 13.6 GHz: <-42 dBc, <-52 dBc (typ.)			
Sweep	Sweep Mode	Step/List sweep; Single/Continuous sweep			
	Sweep Points	2 to 65,535 (Step sweep); 1 to 6,001 (List sweep)			
Modulation Type		AM, FM, PM, pulse modulation, and I/Q modulation (frequency range of AM, PM, PM, and pulse modulation ≤3.6 GHz)			
AM	Modulation Depth	0% to 100%			
	Setting Uncertainty	<4% of setting + 1%			
	Modulation Frequency Response	<3 dB (m < 80%, DC/10 Hz to 100 kHz)			
FM	Max. Deviation	N ^[1] x 1 MHz			
	Setting Uncertainty	< 2% of setting + 20 Hz			
	Modulation Frequency Response	<3 dB (10 Hz to 100 kHz)			

Model		DSG3065B	DSG3065B-IQ	DSG3136B	DSG3136B-IQ
PM	Max. Deviation	N ^[1] x 5 rad			
	Setting Uncertainty	<1% of setting + 0.1 rad			
	Modulation Frequency Response	<3 dB (DC/10 Hz to 100 kHz)			
Pulse Modulation	On/Off Ratio	>70 dB(100 kHz ≤ f <3.6 GHz)			
	Rise/Fall Time	<50 ns (typ.)			
	Pulse Mode	Single pulse, pulse train (option DSG3000B-PUG)			
I/Q Modulation (Only Available for DSG3065B-IQ and DSG3136B-IQ)	Bandwidth	External modulation: baseband (I or Q): up to 60 MHz; RF(I+Q): up to 120 MHz Internal modulation: baseband (I or Q): up to 30 MHz; RF (I+Q): up to 60 MHz			
	EVM	≤ 2%rms (typ.)			
General Specifications	I/O	Standard: USB and LAN			
		Front Panel: RF output, internal modulation generator (LF) output, and external modulation input (EXT MOD)			
		Rear panel: external trigger input (Trigger In), signal valid output (Signal Valid Out), pulse input/output (Pulse In/Out), and reference clock (10 MHz In/Out)			

NOTE:

[1]: f < 227.5 MHz, N = 0.25; 227.5 MHz ≤ f < 455 MHz, N = 0.125; 455 MHz ≤ f < 910 MHz, N = 0.25; 910 MHz ≤ f < 1820 MHz, N=0.5; 1820 MHz ≤ f ≤ 3600 MHz, N=1; 3600 MHz < f ≤ 6500 MHz, N=2; 6500 MHz < f ≤ 13600 MHz, N=4.

Order Information

	Description	Order No.
Model	DSG3065B (RF Signal Generator, 9 kHz to 6.5 GHz)	DSG3065B
	DSG3065B-IQ (RF Signal Generator, 9 kHz to 6.5 GHz, IQ Modulation (Std.))	DSG3065B-IQ
	DSG3136B (RF Signal Generator, 9 kHz to 13.6 GHz)	DSG3136B
	DSG3136B-IQ (RF Signal Generator, 9 kHz to 13.6 GHz, IQ Modulation (Std.))	DSG3136B-IQ
Standard Accessories	Power Cord Conforming to the Standard of the Destination Country	-

	Description	Order No.
Optional Accessories	Pulse Modulation, Pulse Generator, and Pulse Train Generator	DSG3000B-PUG
	Highly Stable Clock Reference (Required to be installed and calibrated before leaving factory)	OEXO-B08
	Rack Mount Kit	RM-DSG3000
	Include: N(F)-N(F) adaptor (1pcs), N(M)-N(M) adaptor (1pcs), N(M)-SMA(F) adaptor (2pcs), N(M)-BNC(F) adaptor (2pcs), SMA(F)-SMA(F) adaptor (1pcs), SMA(M)-SMA(M) adaptor (1pcs), BNC T type adaptor (1pcs), 50 Ω SMA load (1pcs), 50 Ω BNC impedance adaptor (1pcs)	RF Adaptor Kit
	Include: 50 Ω to 75 Ω adaptor (2pcs)	RF CATV Kit
	Include: 6 dB attenuator (1pcs), 10 dB attenuator (2pcs)	RF Attenuator Kit
	N(M)-N(M) RF Cable	CB-NM-NM-75-L-12G
	N(M)-SMA(M) RF Cable	CB-NM-SMAM-75-L-12G
	USB-GPIB Adaptor	USB-GPIB

DSG800/A Series RF Signal Generator



The DSG800 series delivers outstanding performance in the same class of economical RF signal generators to address the demands of RF components manufacturing, IoT, wireless communication, education and training, as well as RF operation and maintenance. With full frequency and power scanning capabilities, as well as AM/FM/ØM analog modulation, powerful pulse modulation and newly added IQ modulation, compared with similar products, the DSG800 has the smallest footprint, light weight and superior portability, making it an excellent choice for educational laboratories, industrial production lines, development and research applications. It breaks through the cost bottle neck of the RF signal, making it become an affordable instrument for every engineer with high quality pure RF signals at an unprecedented price point.

The DSG800 series has 6 models: DSG815/DSG830/DSG821/DSG836/DSG821A/DSG836A, with the frequencies ranging from 9 kHz, 1.5 GHz, 2.1 GHz, 3 GHz, and 3.6 GHz. The typical phase noise can reach up to -112 dBc/Hz, amplitude accuracy up to 0.5 dB. It has a standard configuration of AM, FM, ØM modulation types. Pulse modulation and pulse train generator are also supported as options. Compact size and portable design suitable for on-site application

- High signal purity, with the typical phase noise up to -112 dBc/Hz
- Max. output power 20 dBm
- Digital ALC circuit ensures stability and accuracy, with amplitude accuracy up to 0.5 dB
- Flexible frequency and amplitude sweep functions
- Complete AM/FM/ØM analog modulation functions
- Open vector modulation function (for A model)
- Powerful pulse modulation and pulse train generator function
- Light weight and compact size, easy to carry and operate

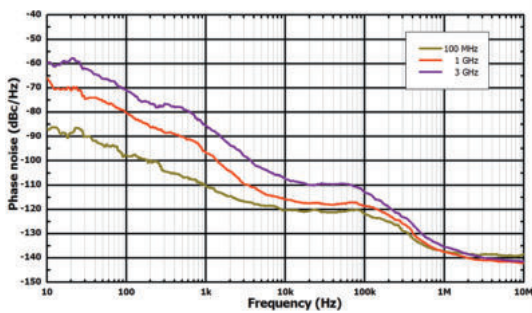

Excellent phase noise

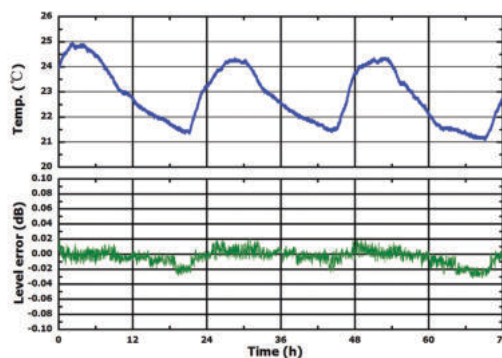

Superb output stability

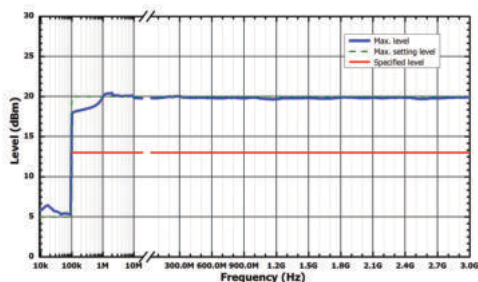

Max. output power 20 dBm

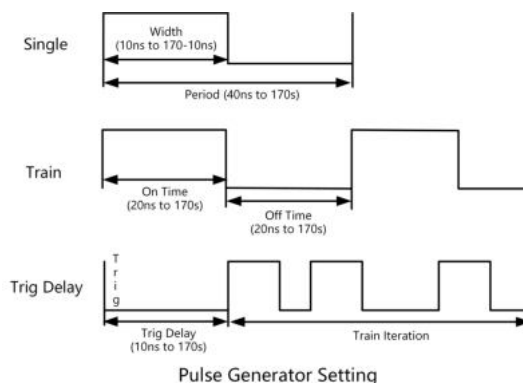

Pulse Generator Setting

Powerful pulse modulation and pulse train generator function

Multiple modulation methods

Simultaneous Modulation					
	Amplitude Modulation	Frequency Modulation	Phase Modulation	Pulse Modulation (Opt.)	I/Q Modulation (Opt.)
Amplitude Modulation	-	○	○	△	×
Frequency Modulation	○	-	×	○	○
Phase Modulation	○	×	-	○	○
Pulse Modulation (Opt.)	△	○	○	-	○
I/Q Modulation (Opt.)	×	○	○	○	-

NOTE:

○:compatible; ×: incompatible; △: compatible, but the AM performance will be undermined when pulse modulation is enabled.

Models and Specifications

Model		DSG815	DSG830	DSG821	DSG821A	DSG836	DSG836A
Frequency Range		9 kHz to 1.5 GHz	9 kHz to 3 GHz	9 kHz to 2.1 GHz	9 kHz to 2.1 GHz	9 kHz to 3.6 GHz	9 kHz to 3.6 GHz
Amplitude Range		-110 dBm to +13 dBm					
Amplitude Setting Range		-110 dBm to +20 dBm					
Amplitude Accuracy		<0.9 dB (<0.5 dB, typ.)					
Clock Reference Stability		<2 ppm <5 ppb(With option OCXO-B08)					
Spectral Purity	SSB Phase Noise	100 kHz \leq f \leq 1.5 GHz, <-105 dBc/Hz (-112dBc/Hz, typ.) 1.5 GHz < f \leq 3.6 GHz, <-99 dBc/Hz (<-106 dBc/Hz, typ.), CW mode, carrier offset = 20 kHz					
	Harmonic Distortion	<-30 dBc, CW mode, 1 MHz \leq f \leq 3 GHz, output level \leq +13 dBm					
	Non-harmonic Distortion	100 kHz \leq f \leq 1.5 GHz, <-60dBc (<-70dBc, typ.) 1.5 GHz \leq f \leq 3 GHz, <-54 dBc/Hz (<-64 dBc/Hz, typ.)					
Sweep	Sweep Mode	Linear sweep, Step/List sweep, Single/Continuous sweep					
	Sweep Points	2 to 65,535 (Step sweep); 1 to 6,001 (List sweep)					
Modulation Type		AM, FM, PM, and pulse modulation					
AM	Modulation Depth	0% to 100%					
	Setting Uncertainty	<4% of setting + 1%					
	Modulation Frequency Response	<3 dB (10 Hz to 100 kHz, m < 80%)					
FM	Max. Deviation	N ^[1] x 1 MHz					
	Setting Uncertainty	<2% of setting + 20 Hz					
	Modulation Frequency Response	<3 dB (10 Hz to 100 kHz)					
PM	Max. Deviation	N ^[1] x 5 rad					
	Setting Uncertainty	<1% of setting + 0.1 rad					
	Modulation Frequency Response	10 Hz to 100 kHz (<3 dB)					
Pulse Modulation	On/Off Ratio	>70 dB(100 kHz \leq f <3 GHz)					
	Rise/Fall Time	<50 ns, 10 ns (typ.)					
	Pulse Mode	Single pulse, pulse train (option DSG800-PUG)					

Model		DSG815	DSG830	DSG821	DSG821A	DSG836	DSG836A
I/Q Modulation (Only Available for A Model)	Bandwidth	External modulation: baseband (I or Q): up to 60 MHz; RF(I+Q): up to 120 MHz Internal modulation: baseband (I or Q): up to 30 MHz; RF (I+Q): up to 60 MHz					
	EVM	≤ 2%rms (typ.)					
General Specifications	I/O	Standard: USB and LAN					
		Front panel: RF output, internal modulation generator (LF) output					
		Rear panel: external trigger input [Trigger In], signal valid output [Signal Valid], Pulse input/output [Pulse In/Out]					
		External modulating signal input [Ext Mod], reference clock [10MHz Ref In/Out]					

NOTE:

[1]: $f < 227.5$ MHz, $N = 0.25$; 227.5 MHz $\leq f < 455$ MHz, $N = 0.125$; 455 MHz $\leq f < 910$ MHz, $N = 0.25$; 910 MHz $\leq f < 1820$ MHz, $N=0.5$; 1820 MHz $\leq f \leq 3600$ MHz, $N=1$.

Order Information

	Description	Order No.
Model	DSG830 (RF Signal Generator, 9 kHz to 3 GHz)	DSG830
	DGS815 (RF Signal Generator, 9 kHz to 1.5 GHz)	DSG815
	DGS821 (RF Signal Generator, 9 kHz to 2.1 GHz)	DSG821
	DGS821A (RF Signal Generator, 9 kHz to 2.1 GHz, with the IQ Modulation)	DSG821A
	DGS836 (RF Signal Generator, 9 kHz to 3.6 GHz)	DSG836
	DGS836A (RF Signal Generator, 9 kHz to 3.6 GHz, with the IQ Modulation)	DSG836A
Standard Accessories	Power Cord Conforming to the Standard of the Destination Country	-
Options	Pulse Modulation, Pulse Train Generator	DSG800-PUM
	Pulse Train Generator (include DSG800-PUM)	DSG800-PUG
	Highly Stable Clock Reference (Required to be installed and calibrated before leaving factory)	OCXO-B08
	Rack Mount Kit (for a single instrument)	RM-1-DG1000Z
	Rack Mount Kit (for two instruments)	RM-2-DG1000Z

Digital Multimeters

DM3000 Series Digital Multimeters

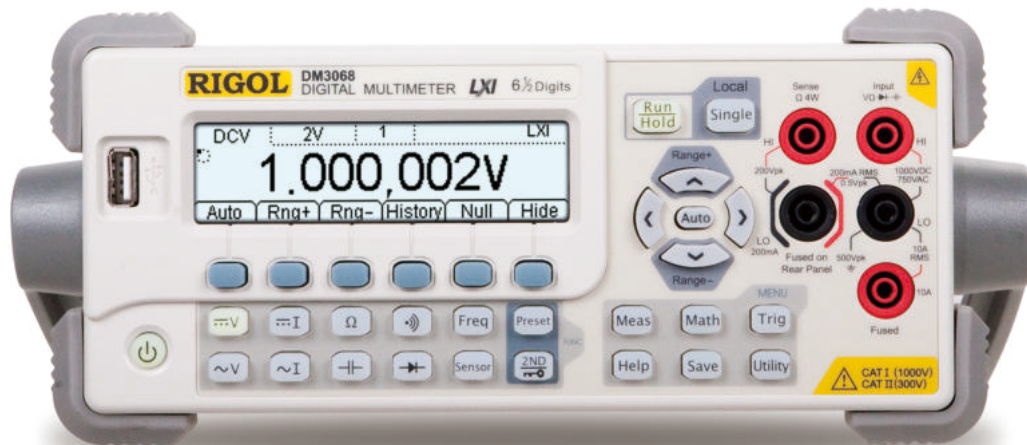

DM3000 series digital multimeters (DM3068, DM3058, DM3058E) are the products designed with multi-functions, high-precision, high performance and automation test. While providing stable and accurate measurements, the DM3000 series is equipped with high-speed data acquisition, automation tests, and any sensor test functions. A variety of interfaces such as GPIB, USB, LAN (LXI-C), and RS232 are available for connectivity. USB storage is supported. To cater to the automation test requirements, the DM3000 series, featuring its fast measurement speed and anti-interference capability, can be used for the production line automation test with the PASS/FAIL control, unified power management, pre-programmed configurations, and configuration setup cloning functions to improve the productivity. DM3000 series digital multimeters are widely used in the fields such as production line tests, scientific research, education, quality assurance, inspection and maintenance.

- $6\frac{1}{2}$ (DM3068) or $5\frac{1}{2}$ digits (DM3058/E) readings resolution
- Max. 10A current range
- Dual display of measurement, capable of displaying parameters of two types of signals
- Support temperature sensors (TC, RTD, and THERM) and user-defined sensor
- Statistical analysis, real-time trend and histogram display (DM3068)
- A variety of interfaces for connectivity, compatible with commands of main stream DMMs

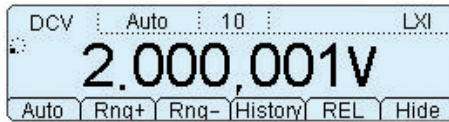

Real 6½ digits readings resolution (DM3068)

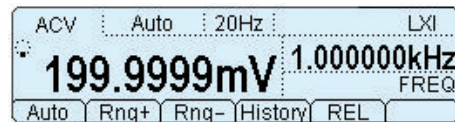

Easy to measure AC signal with dual display

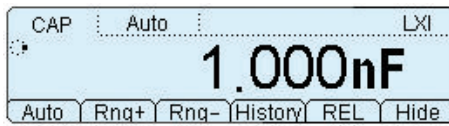

Capacitor measurement function

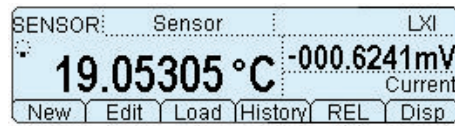

"Any sensor" measurement

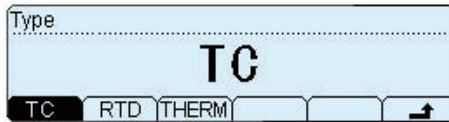

Support multiple temperature sensors (TC, RTD, and THERM)

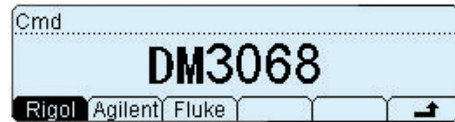

Support multiple commands



Histogram display

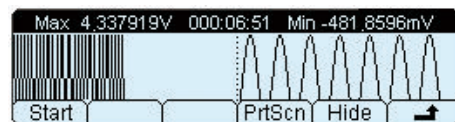

Trend display

Models and Specifications

Function	Range	Optimal Annual Accuracy Specifications ±(readout%+range%)(Tca123°C±5°C)	
		DM3068	DM3058/E
DC Voltage	200.000 mV to 1000.00 V	0.0035 + 0.0006	0.015 + 0.003
DC Current	200.000 µA to 10.0000 A	0.030 + 0.003	0.055 + 0.005
AC Voltage (RMS)	200.000 mV to 750.000 V	0.06 + 0.04	0.2 + 0.05
AC Current (RMS)	200.000 µA to 10.00000 A ^[1]	0.10 + 0.04	0.30 + 0.10
Resistance	200.000 Ω to 100.000 MΩ	0.010 + 0.001	0.020 + 0.003
Diode Test	2.000 V/1 mA	0.010 + 0.020	0.05 + 0.01
Connectivity Test	2000.0 Ω/1 mA	0.010 + 0.020	0.05 + 0.01
Period/Frequency	3 Hz to 1 MHz (200 mV to 750 V)	0.007	0.01 + 0.003
Capacitance	2.000 nF to 100.0 mF ^[2]	1 + 0.3	1 + 0.5
Max. Reading Speed	-	10000 rdgs/s	123 rdgs/s
Volatile Memory	-	512 k readings of history records	2000 readings of history records
Remote Command	-	RIGOL, Agilent, and FLUKE	

NOTE:

[1]: DM3058/E ACI range: 20 mA to 10 A

[2]: DM3058/E Cap range: 2 nF to 10 μ F

Order Information

	Description	Order No.
Model	DM3068 (6½ digits; dual display bench DMM; standard GPIB, LAN, USB, and RS232 interfaces for connectivity)	DM3068
	DM3058 (5½ digits; dual display bench DMM; standard GPIB, LAN, USB, and RS232 interfaces for connectivity)	DM3058
	DM3058E (5½ digits; dual display bench DMM; standard USB and RS232 interfaces for connectivity)	DM3058E
Standard Accessories	Test Lead x2 (black and red)	LD-DM
	Alligator Clip x2 (black and red)	ALLIGATORCLIP-DMM
	USB Cable x1	CB-USBA-USBB-FF-150
	Spare Fuses (4 for DM3068; 2 for DM3058/E)	-
	Power Cord Conforming to the Standard of the Destination Country	-
Optional Accessories	Kelvin Test Clip	KELVINTESTCLIP-DMM
	RS232 Cable	CB-DB9-DB9-F-F-150
	Rack Mount Kit	RM-DM3000

Data Acquisition/Switch System

M300 Series Data Acquisition/Switch System



The M300 series data acquisition/switch system with modular structure combines precision measurement capability with flexible signal connections, which can provide various solutions for the applications with multiple test points or signals to be tested in product performance test during R&D phase as well as automation test during production process.

- 6½ digit DMM offers high accuracy, supporting multiple measurement functions, including DCV,DCI, ACV, ACI, 2WR, 4WR, PERIOD, FREQ, TEMP (thermocouple, thermister, and RTD) and any sensor
- 4.3" TFT LCD, easy for operation
- Up to 320 switch channels for a single instrument
- 8 modules supported
- Standard configuration of a variety of communication interfaces: USB Device, USB Host, GPIB, LAN(LXI-C), and RS232
- Powerful PC control and analysis software



Measurement Configuration

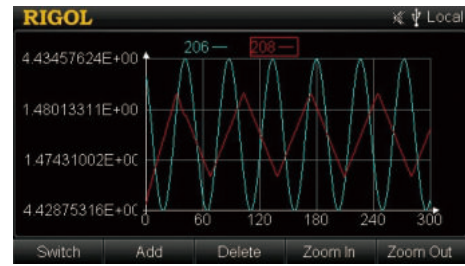

Draw Real-Time Scan Data Curves

Models and Specifications

Module	Description
MC3065	DMM module, 6½ digits, support functions: DCV, ACV, DCI, ACI, 2WR, 4WR, FREQ, PERIOD, TEMP and any sensor
MC3120	20-channel HI/LO (differential) input; 4-wire measurement
MC3132	32-channel HI/LO (differential) input; 4-wire measurement
MC3164	64-channel (single-ended), switch HI input only
MC3324	Mixed multiplexer with 20 voltage channels and 4 current channels
MC3416	16-channel actuator that can connect signal to the device under test or enable the external device
MC3534	Multifunction module. <ul style="list-style-type: none"> • DIO: four 8-bit digital input/output ports • TOT: four totalizer input terminals • DAC: four analog output terminals
MC3648	4x8 two-wire matrix switch

Module	Terminal Block	No. of Test Channels			
		20	24	32	64
MC3065	-	-	-	-	-
MC3120	TB20	•	-	-	-
MC3132	TB32	-	-	•	-
MC3164	TB64	-	-	-	•
MC3324	TB24	-	•	-	-
MC3416	TB16	-	-	-	-
MC3534	TB34	-	-	-	-
MC3648	TB48	-	-	-	-

Order Information

	Description	Order No.
Model	M300 Data Acquisition/Switch System	M300
	M301 Data Acquisition/Switch System + DMM Module	M301
	M302 Data Acquisition/Switch System + DMM Module + MC3120 20-channel Multiplexer	M302

	Description	Order No.
Module	DMM Module (6 ^{1/2} digits)	MC3065
	20-channel Multiplexer	MC3120 (Required to work with M3TB20)
	32-channel Multiplexer	MC3132 (Required to work with M3TB32)
	64-channel Single-ended Multiplexer	MC3164 (Required to work with M3TB64)
	20-voltage-channel + 4-current-channel Mixed Multiplexer	MC3324 (Required to work with M3TB24)
	16-channel Actuator	MC3416 (Required to work with M3TB16)
	Multifunction Module	MC3534 (Required to work with M3TB34)
	4x8 Matrix Switch	MC3648 (Required to work with M3TB48)
Terminal Block	MC3120	M3TB20
	MC3324	M3TB24
	MC3648	M3TB48
	MC3534	M3TB34
	MC3416	M3TB16
	MC3132	M3TB32
	MC3164	M3TB64
Standard Accessories	USB Cable x1	CB-USBA-USBB-FF-150
	Mixed-interface Separator Line	MIX-SEPARATOR
	Power Cord	--
	Spare Fuses	--
Optional Accessories	RS232 Cable	CB-DB9-DB9-FF-150
	GPIB Reverse Entry Extender	M3GPIB
	External Bus Interface	M3A2B
	Rack Mount Kit (for a single instrument)	RM-1-M300
	Rack Mount Kit (for two instruments)	RM-2-M300
	PC Control and Advanced Data Analysis Software for M300 Series	UltraAquirePro

Programmable Linear DC Power Supplies



DP2000, DP900, DP800, and DP700 series are programmable linear DC power supplies with high performance. They feature powerful timing outputs, extremely low ripple and noise, comprehensive overvoltage, over current, over-temperature protection, fast transient response, large and clear user interface, excellent specifications, multiple interfaces for connectivity, capable of meeting both benchtop and integrated testing requirements.

Models and Specifications

Model	No. of Channels	Max. Range for Each Channel	Maximum Power	Ripple and Noise	Voltage Programming Resolution (Std.)
DP711	1	30 V/5 A	150 W	<500 μ Vrms	10 mV
DP712	1	50 V/3 A	150 W	<500 μ Vrms	10 mV
DP811	1	20 V/10 A or 40 V/5 A	200 W	<350 μ Vrms	10 mV
DP821	2	8 V/10 A, 60 V/1 A	140 W	<350 μ Vrms	10 mV/10 mV
DP832	3	30 V/3 A, 30 V/3 A, 5 V/3 A	195 W	<350 μ Vrms	10 mV/10 mV/10 mV
DP831	3	8 V/5 A, 30 V/2 A, -30 V/2 A	160 W	<350 μ Vrms	1 mV/10 mV/10 mV
DP811A	1	20 V/10 A or 40 V/5 A	200 W	<350 μ Vrms	1 mV
DP821A	2	8 V/10 A, 60 V/1 A	140 W	<350 μ Vrms	1 mV/1 mV
DP832A	3	30 V/3 A, 30 V/3 A, 5 V/3 A	195 W	<350 μ Vrms	1 mV/1 mV/1 mV
DP831A	3	8 V/5 A, 30 V/2 A, -30 V/2 A	160 W	<350 μ Vrms	1 mV/1 mV/1 mV
DP932E	3	30 V/3 A, 30 V/3 A, 6 V/3 A	198 W	\leq 350 μ Vrms	10 mV/10 mA, 1 mV/1 mA
DP932U	3	32 V/3 A, 32 V/3 A, 6 V/3 A	210 W	\leq 350 μ Vrms	10 mV/1 mA, 1 mV/1 mA
DP932A	3	32 V/3 A, 32 V/3 A, 6 V/3 A	210 W	\leq 350 μ Vrms	1 mV/1 mA
DP2031	3	32 V/3 A, 32 V/3 A, 6 V/5 A	222 W	<350 μ Vrms	1 mV/0.1 mA, 1 mV/1 mA

	DP711	DP712	DP811	DP821	DP832	DP831	DP811A	DP821A	DP832A	DP831A	DP932E	DP932U	DP932A	DP2031
High Resolution	○	○	○	○	○	○	●	●	●	●	○	○	●	●
Monitor	-	-	○	○	○	○	●	●	●	●	-	-	-	-
Analyzer	-	-	○	○	○	○	●	●	●	●	●	●	●	●
Timer	○	○	●	●	●	●	●	●	●	●	-	-	-	-
Digital I/O	-	-	○	○	○	○	●	●	●	●	-	○	●	●
Multi-Device Synchronization	○	○	-	-	-	-	-	-	-	-	-	-	-	-

DP2031	●
DP932A	-
DP932U	-
DP932E	-
DP831A	●
DP832A	●
DP821A	●
DP811A	●
DP831	○
DP832	○
DP821	○
DP811	○
DP712	-
DP711	-

Note:

- Standard ○ Option

DP2000 Series Programmable Linear DC Power Supply



- 3 independent channels: 32 V/3 A || 32 V/3 A || 6 V/5 A(10 A)
- 4.3" LCD color touch screen
- High resolution for measurement of 1 μ A low current
- Dynamic current waveform measurement and display
- Front-panel and rear-panel output terminals
- Output ripple and noise below 350 μ V_{rms}/2 mV_{pp}
- Command processing time < 10 ms
- Multiple interfaces for connectivity: USB, LAN, Digital IO, and RS232
- OVP/OCP/OTP protection
- PC software control
- Standard 3U height, half rack width
- Support 1 ms pulse current waveform measurement



Low-power IoT device testing

No.	Volt(V)	Curr(A)	Time(s)	Single
1	0.500	1.0000	0.001	Delete
2	0.600	1.0000	0.001	Clear
3	0.600	1.0000	0.001	Templet
4	0.700	1.0000	0.001	Back

CH1 Prev 1 / 13 Next Back

0.000V	0.00V	0.000V	0.00V	0.000V	0.00V
0.000A	0.10A	0.000A	0.10A	0.000A	0.10A
OVP	OCF	OVP	OCF	OVP	OCF

Min. dwell time: 1 ms



4.3" touch screen



ATE testing

Models and Specifications

Model			DP2031
Number of Channels			3
DC Output	Voltage/ Current	Range1	CH1: 0 to 32 V/0 to 3 A CH2: 0 to 32 V/0 to 3 A CH3: 0 to 6 V/0 to 5 A
		Range2	CH1: 0 to 32 V/0 to 2 A CH2: 0 to 32 V/0 to 2 A CH3: 0 to 6 V/0 to 10 A
	OVP/OCF	Range1	CH1: 1 mV to 35.2 V/1 mA to 3.3 A CH2: 1 mV to 35.2 V/1 mA to 3.3 A CH3: 1 mV to 6.6 V/1 mA to 5.5 A
		Range2	CH1: 1 mV to 35.2 V/1 mA to 2.2 A CH2: 1 mV to 35.2 V/1 mA to 2.2 A CH3: 1 mV to 6.6 V/1 mA to 11 A
Load Regulation	Voltage	<0.01% + 2 mV	
	Current	<0.01% + 250 μA	

Model		DP2031
Line Regulation	Voltage	<0.01% + 2 mV
	Current	<0.01% + 250 μ A
Ripple Noise (20 Hz to 20 MHz)	Normal Mode Voltage	<350 μ V _{rms} /2 mV _{pp}
	Normal Mode Current	<2 mA _{rms}
Internal Series/Parallel Mode Output	Serial Mode Voltage	64 V
	Parallel Mode Current	6 A
Transient Response Time		Less than 50 μ s for output voltage to recover to within 15 mV following a change in output current from full load to half load or vice versa
Command Processing Time ^[1]		<10 ms
OVP Accuracy, \pm (% of Output + Offset)		0.2% + 20 mV
OCP Accuracy, \pm (% of Output + Offset)		0.5% + 20 mA
I/O		USB DEVICE x1, USB HOST x2 (1 on the front panel and 1 on the rear panel), LAN x1, RS232 x1, Digital IO x1, and rear-panel output connector x3
Dimensions		239 mm (W) x 157 mm (H) x 419 mm (D)
Weight		9.95 kg

NOTE:

[1]: The time required for the output to change accordingly after receiving the APPLy and SOURce commands.

Order Information

Order Information	Order No.
Model	
DP2031 (3CH High-Accuracy Programmable Linear DC Power Supply)	DP2031
Standard Accessories	
USB Cable	CB-USBA-USBB-FF-150
Fuse x1	-
Power Cord Conforming to the Standard of the Destination Country	-
10 A Test Output Lead x3	10A-Testing-Cable
Optional Accessories	
CH3 10 A High Current Range	DP2000-10A
7.5 kSa/s High-Speed Current Sampling	DP2000-HADC
DP2000 Rack Mount Kit (For a Single Instrument)	RM-1-DP800
DP2000 Rack Mount Kit (For Two Instruments)	RM-2-DP800

NOTE:

For all the mainframes, accessories, and options, please contact the local office of RIGOL.

DP900 Series Programmable Linear DC Power Supply



- 4.3" LCD color touch screen
- Internal series/parallel connections for CH1 and CH2
- Galvanic isolation among 3 channels, independent output, max. output power of 210 W
- Fast transient response time: <math>< 50 \mu\text{s}</math>
- Output ripple and noise below $350 \mu\text{V}_{\text{rms}}/2 \text{ mV}_{\text{pp}}$
- Command processing time <math>< 10 \text{ ms}</math>
- A maximum of 512 arbitrary points with dwell time down to 100 ms; various built-in basic waveforms
- OVP/OCP/OTP protection
- Multiple interfaces for connectivity: USB, LAN, and Digital IO



4.3" touch screen

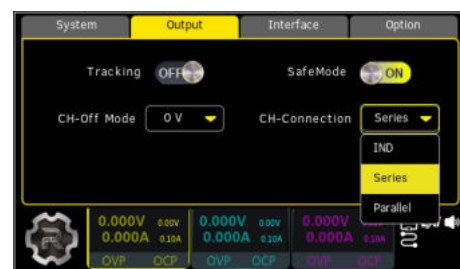

Auto Series & Parallel operation



Min. dwell time: 100 ms



Safety terminal

Models and Specifications

Model	DP932A	DP932U	DP932E
Number of Channels	3		
DC Output	Voltage/Current	CH1: 0 to 32 V/0 to 3 A CH2: 0 to 32 V/0 to 3 A CH3: 0 to 6 V/0 to 3 A	CH1: 0 to 30 V/0 to 3 A CH2: 0 to 32 V/0 to 3 A CH3: 0 to 6 V/0 to 3 A
	OVP/OCP	CH1: 1 mV to 35.2 V/1 mA to 3.3 A CH2: 1 mV to 35.2 V/1 mA to 3.3 A CH3: 1 mV to 6.6 V/1 mA to 3.3 A	CH1: 1 mV to 33 V/1 mA to 3.3 A CH2: 1 mV to 33 V/1 mA to 3.3 A CH3: 1 mV to 6.6 V/1 mA to 3.3 A
Load Regulation	Voltage ^[1]	<0.01% + 2 mV	
	Current	<0.01% + 250 μA	
Line Regulation	Voltage	<0.01% + 2 mV	
	Current	<0.01% + 250 μA	
Ripple Noise (20 Hz to 20 MHz)	Normal Mode Voltage	<350 μV _{rms} /2 mV _{pp}	
	Normal Mode Current	<2 mA _{rms}	
Internal Series/Parallel Mode Output	Serial Mode Voltage	64V	
	Parallel Mode Current	6A	
Transient Response Time	Less than 50 μs for output voltage to recover to within ±15 mV following a change in output current from full load to half load or from half load to full load		
Command Processing Time ^[2]	<10 ms		
OVP Accuracy, ±(% of Output + Offset)	0.2% + 20 mV		
OCP Accuracy, ±(% of Output + Offset)	0.5% + 20 mA		
I/O	USB DEVICE x1, USB HOST x2 (1 on the front panel and 1 on the rear panel), LAN x1, Digital IO x1 (option for DP932U, unavailable for DP932E)		

Model	DP932A	DP932U	DP932E
Dimensions	239 mm (W) x 157 mm (H) x 419 mm (D)		
Weight	9.15kg		

NOTE:

[1]: Due to the structure design of the terminal of DP932U, the voltage load regulation cannot be guaranteed.

[2]: The time required for the output to change accordingly after receiving the APPLy and SOURce commands.

Order Information

Order Information	Order No.
Model	
DP932A (3CH High-Resolution Programmable Linear DC Power Supply)	DP932A
DP932U (3CH Programmable Linear DC Power Supply, with Safety Terminal, Dedicated for University Education and Teaching)	DP932U
DP932E (3CH Programmable Linear DC Power Supply, Dedicated for E-commerce Sale)	DP932E
Standard Accessories	
USB Cable	CB-USBA-USBB-FF-150
Fuse x1	-
Power Cord Conforming to the Standard of the Destination Country	-
10 A Test Output Lead x3	10A-Testing-Cable
Optional Accessories	
1 mA & 1 mV High Resolution	DP900-HIRES
Min. Arb Dwell Time 100 ms (Only Available for DP932U)	DP900-ARB
4 Trigger Input/Output Channels (Only Available for DP932U)	DP900-DIGITALIO
DP900 Rack Mount Kit (For a Single Instrument)	RM-1-DP800
DP900 Rack Mount Kit (For Two Instruments)	RM-2-DP800

NOTE:

For all the mainframes, accessories, and options, please contact the local office of RIGOL.

DP800 Series Programmable Linear DC Power Supply



DP800 series power supply is a type of programmable linear DC power supply with high performance. It has powerful timing outputs, extremely low ripple and noise, comprehensive overvoltage, over current, over-temperature protection, fast transient response, large and clear user interface, excellent specifications, multiple interfaces for connectivity, capable of meeting both workbench testing and integrated testing requirements. DP800A models provide standard high resolution mode (1 mV/1 mA), with multiple interfaces available.

- 1, 2, or 3 outputs, with the max. power up to 200 W
- Low ripple and noise: $<350 \mu\text{Vrms}/2 \text{ mVpp}$
- Quick transient response time: $<50 \mu\text{s}$
- 0.01% line regulation and load regulation
- Standard timing output, built-in V/A/W measurements and waveform display
- 3.5" TFT display, easy for operation

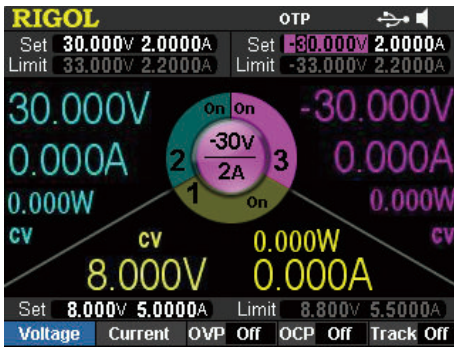

Intuitive and clear display

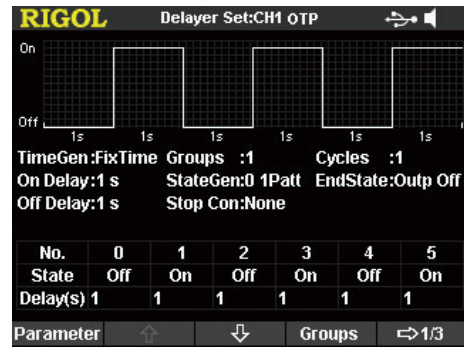

Output On/Off delay

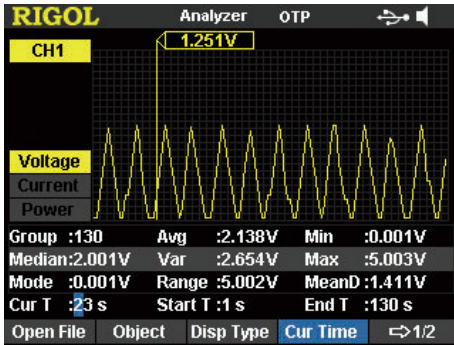

Output Analysis

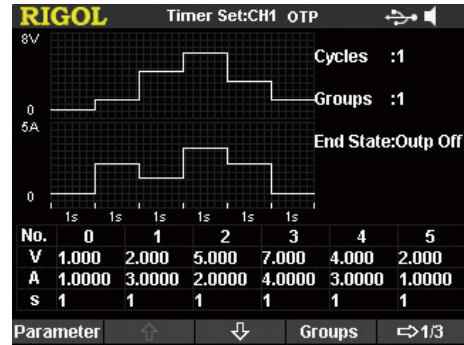

Standard timing output



V/W/A waveform display

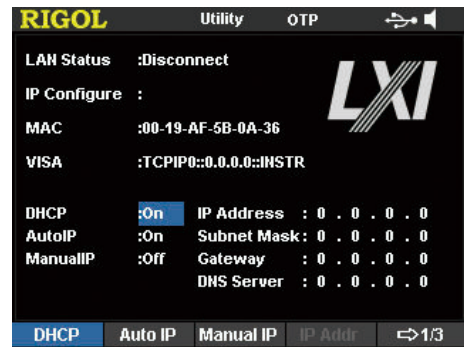

LAN setting

Models and Specifications

Model	DP832/A	DP831/A	DP822/A	DP821/A	DP813/A	DP811/A
No. of Channels	3		2		1	
DC Output	30 V/3 A, 30 V/3 A, 5 V/3 A	8 V/5 A, 30 V/2 A, -30 V/2 A	20 V/5 A, 5 V/16 A	8 V/10 A, 60 V/1 A	8 V/20 A (low range) or 20 V/10 A (high range)	20 V/10 A (low range) or 40 V/5 A (high range)
Load Regulation	Voltage: <0.01% + 2 mV; current: <0.01% + 250 μA					
Line Regulation	Voltage: <0.01% + 2 mV; current: <0.01% + 250 μA					

Model		DP832/A	DP831/A	DP822/A	DP821/A	DP813/A	DP811/A	
Ripple Noise (20 Hz to 20 MHz)	Normal Mode Voltage	<350 μV_{rms} /2 mV _{pp}				<350 μV_{rms} /3 mV _{pp}		
	Normal Mode Current	<2 mA _{rms}						
Annual Programming Accuracy	Voltage	CH1	0.05% + 20 mV	0.1% + 5 mV	0.1% + 25 mV	0.1% + 25 mV	0.05% + 10 mV	0.05% + 10 mV
		CH2	0.05% + 20 mV	0.05% + 20 mV	0.05% + 10 mV	0.05% + 10 mV	-	-
		CH3	0.1% + 5 mV	0.05% + 20 mV	-	-	-	-
	Current	CH1	0.2% + 5 mA	0.2% + 10 mA	0.2% + 10 mA	0.2% + 10 mA	0.1% + 10 mA	0.1% + 10 mA
		CH2	0.2% + 5 mA	0.2% + 5 mA	0.2% + 10 mA	0.2% + 10 mA	-	-
		CH3	0.2% + 5 mA	0.2% + 5 mA	-	-	-	-
Annual Readback Accuracy	Voltage	CH1	0.05% + 20 mV	0.1% + 5 mV	0.1% + 25 mV	0.1% + 25 mV	0.05% + 10 mV	0.05% + 10 mV
		CH2	0.05% + 20 mV	0.05% + 20 mV	0.05% + 5 mV	0.05% + 10 mV	-	-
		CH3	0.1% + 5 mV	0.05% + 20 mV	-	-	-	-
	Current	CH1	0.15% + 5 mA	0.2% + 10 mA	0.15% + 10 mA	0.15% + 10 mA	0.1% + 10 mA	0.1% + 10 mA
		CH2	0.15% + 5 mA	0.1% + 5 mA	0.15% + 10 mA	0.15% + 10 mA	-	-
		CH3	0.15% + 5 mA	0.1% + 5 mA	-	-	-	-

Model	Programming Resolution		Readback Resolution		Display Resolution	
	Voltage	Current	Voltage	Current	Voltage	Current

3CH Model

DP832A	1 mV/1 mV/1 mV	1 mA/1 mA/1 mA	0.1 mV/0.1 mV/0.1 mV	0.1 mA/0.1 mA/0.1 mA	1 mV/1 mV/1 mV	1 mA/1 mA/1 mA
DP832	10 mV/10 mV/10 mV	1 mA/1 mA/1 mA	10 mV/10 mV/10 mV	1 mA/1 mA/1 mA	10 mV/10 mV/10 mV	10 mA/10 mA/10 mA
DP831A	1 mV/1 mV/1 mV	0.3 mA/0.1 mA/0.1 mA	0.1 mV/0.1 mV/0.1 mV	0.1 mA/0.1 mA/0.1 mA	1 mV/1 mV/1 mV	1 mA/1 mA/1 mA
DP831	1 mV/10 mV/10 mV	1 mA/1 mA/1 mA	1 mV/1 mV/1 mV	1 mA/1 mA/1 mA	10 mV/10 mV/10 mV	10 mA/10 mA/10 mA

2CH Model

DP822A	1 mV/1 mV	1 mA/1 mA	1 mV/1 mV	0.1 mA/1 mA	1 mV/1 mV	0.1 mA/1 mA
DP822	10 mV/10 mV	10 mA/10 mA	10 mV/10 mV	1 mA/10 mA	10 mV/10 mV	10 mA/10 mA
DP821A	1 mV/1 mV	0.1 mA/1 mA	1 mV/1 mV	0.1 mA/1 mA	1 mV/1 mV	0.1 mA/1 mA
DP821	10 mV/10 mV	1 mA/10 mA	10 mV/10 mV	1 mA/10 mA	10 mV/10 mV	1 mA/10 mA

Single-channel Model

Model	Programming Resolution		Readback Resolution		Display Resolution	
	Voltage	Current	Voltage	Current	Voltage	Current
DP813A	1 mV	1 mA	1 mV	1 mA	1 mV	1 mA
DP813	10 mV	10 mA	10 mV	10 mA	10 mV	10 mA
DP811A	1 mV	0.5 mA	0.1 mV	0.1 mA	1 mV	1 mA
DP811	10 mV	10 mA	1 mV	1 mA	10 mV	10 mA

I/O

Model	DP832A	DP832	DP831A	DP831	DP822A	DP822	DP821A	DP821	DP813A	DP813	DP811A	DP811
USB Device	•	•	•	•	•	•	•	•	•	•	•	•
USB Host	•	•	•	•	•	•	•	•	•	•	•	•
LAN	•	○	•	○	•	○	•	○	•	○	•	○
RS232	•	○	•	○	•	○	•	○	•	○	•	○
Digital IO	•	○	•	○	•	○	•	○	•	○	•	○

Order Information

	Description	Order No.
Model	DP832A (3CH High-Resolution Programmable Linear DC Power Supply)	DP832A
	DP832 (3CH Programmable Linear DC Power Supply)	DP832
	DP831A (3CH Dual-Polarity Output High-Resolution Programmable Linear DC Power Supply)	DP831A
	DP831 (3CH Dual-Polarity Output Programmable Linear DC Power Supply)	DP831
	DP822A (2CH High-Resolution Programmable Linear DC Power Supply)	DP822A
	DP822 (2CH Programmable Linear DC Power Supply)	DP822
	DP821A (2CH High-Resolution Programmable Linear DC Power Supply)	DP821A
	DP821 (2CH Programmable Linear DC Power Supply)	DP821
	DP813A (Single-channel Programmable Linear DC Power Supply)	DP813A
	DP813 (Single-channel Programmable Linear DC Power Supply)	DP813
	DP811A (Single-channel Dual-range High Resolution Programmable Linear DC Power Supply)	DP811A
	DP811 (Single-channel Dual-range Programmable Linear DC Power Supply)	DP811

	Description	Order No.
Standard Accessories	USB Cable x1	CB-USBA-USBB-FF-150
	Fuse 50T-032H 250V 3.15A (DP832A/DP832/DP822A/DP822/DP813A/DP813/DP811A/DP811)	-
	Fuse 50T-025H 250V 2.5A (DP831A/DP831/DP821A/DP821)	-
	Short-circuit Equipment (DP822A/DP822/DP821A/DP821/DP813A/DP813/DP811A/DP811)	-
	Power Cord Conforming to the Standard of the Destination Country	-
Optional Accessories	High Resolution (Option for DP832/DP831/DP822/DP821/DP813/DP811; Standard for Other Models)	HIRES-DP800
	4 Trigger Input/Output Channels (Option for DP832/DP831/DP822/DP821/DP813/DP811; Standard for Other Models)	DIGITALIO-DP800
	Online Monitoring and Analysis (Option for DP832/DP831/DP822/DP821/DP813/DP811; Standard for Other Models)	AFK-DP800
	RS232 and LAN (Option for DP832/DP831/DP822/DP821/DP813/DP811; Standard for Other Models)	INTERFACE-DP800
	DP800 Series Green Safety Plug	SPG-DP800
	DP800 Rack Mount Kit (For a Single Instrument)	RM-1-DP800
	DP800 Rack Mount Kit (For Two Instruments)	RM-2-DP800

DP700 Series Programmable Linear DC Power Supply



DP700 series power supply is a type of affordable programmable linear DC power supply with high performance. With superb performance specifications, pure and reliable output, and clear user interface, the DP700 series supports timing output and trigger function, enabling you to meet your diversified test requirements.

- Two models, single output, total power up to 150 W
- Low ripple and noise: <math>< 500 \mu\text{Vrms}</math>/3 mVpp or 4 mVpp
- 0.01% line regulation and load regulation
- 1 mV/1 mA resolution (opt.)
- Sound overvoltage/overcurrent/overtemperature protection, with the response time for the overvoltage protection less than 10 ms
- External trigger function supported, enabling synchronous output for multiple devices
- Timing output supported for up to 2,048 groups
- 3.5-inch TFT-LCD; compact and elegant; easy to use

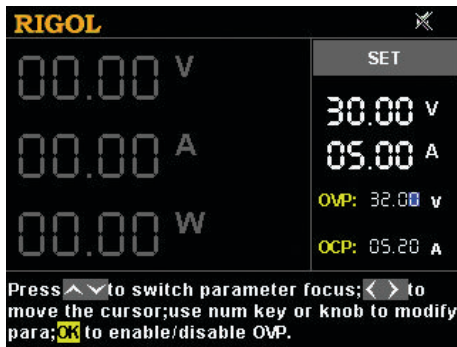

Sound overvoltage/overcurrent protection (OVP/OCP)

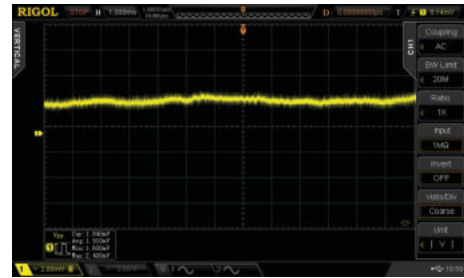

Low ripple and noise

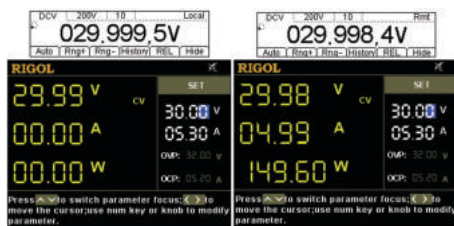

0.01% line regulation and load regulation

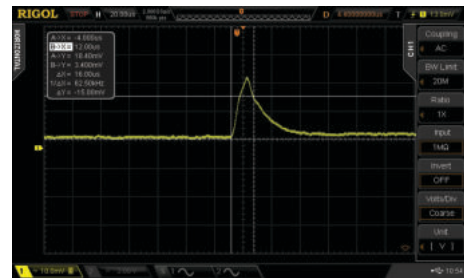

Fast transient response time

Models and Specifications

Model	Rated Voltage/Current	OVP/OCP
DP711	0 V to 30 V/0 A to 5 A	0.01 V to 33 V/0.01 A to 5.5 A
DP712	0 V to 50 V/0 A to 3 A	0.01 V to 55 V/0.01 A to 3.3 A
Load Regulation, ±(% of Output + Offset)		
Voltage	<0.01% + 2 mV	
Current	<0.01% + 2 mA	
Line Regulation, ±(% of Output + Offset)		
Voltage	<0.01% + 2 mV	
Current	<0.01% + 2 mA	
Ripple and Noise (20 Hz to 20 MHz)		
Model	Normal Mode Voltage	Normal Mode Current
DP711	<500 μVrms/3 mVpp	<2 mArms
DP712	<500 μVrms/4 mVpp	
Annual Accuracy (25°C ± 5°C), ±(% of Output + Offset)		
Programming	Voltage	0.05% + 20 mV
	Current	0.2% + 10 mA
Readback	Voltage	0.05% + 20 mV
	Current	0.2% + 20 mA

Model	Rated Voltage/Current		OVP/OCP
Resolution			
Programming	Voltage	10 mV (std.)	1 mV (with high resolution option installed)
	Current	10 mV (std.)	1 mV (with high resolution option installed)
Readback	Voltage	Standard: 10 mV	High resolution option installed: 1 mV
	Current	10 mV (std.)	1 mV (with high resolution option installed)
Display	Voltage	Standard: 10 mV	High resolution option installed: 1 mV
	Current	10 mV (std.)	1 mV (with high resolution option installed)
Transient Response Time			
Less than 50 μ s for output voltage to recover to within 15 mV following a change in output current from full load to half load or from half load to full load.			
Mechanical			
Size	140 mm (W) x 202 mm (H) x 332 mm (D)		
Weight	Net weight: 6.9 kg		
I/O			
RS232	1		

Order Information

	Description	Order No.
Model	DP711 (Programmable Linear DC Power Supply, 1CH, 30 V/5A)	DP711
	DP712 (Programmable Linear DC Power Supply, 1CH, 50 V/3A)	DP712
Standard Accessories	Power Cord Conforming to the Destination Country	-
	Either one of the following fuses: <ul style="list-style-type: none"> Fuse 50T-050H250V 5A (voltage selector: 100 Vac/120 Vac) Fuse 50T-025H250V 2.5A (voltage selector: 220 Vac/240 Vac) 	-
Optional Accessories	High Resolution	HIRES-DP700
	Trigger (external synchronous trigger input and output)	TRIGGER-DP700
	Timer	TIMER-DP700
	9-Pin RS232 Cable (female-to-female, straight)	CB-DB9-DB9-F-F-150
	DP700 Series Rack Mount Kit (for a single instrument)	RM-1-DP700
	DP700 Series Rack Mount Kit (for two instruments)	RM-2-DP700
	DP700 Series Rack Mount Kit (for three instruments)	RM-3-DP700

Programmable DC Electronic Load

DL3000 Series Programmable DC Electronic Load



DL3000 is a cost-effective programmable DC electronic load with high performance. With a user-friendly interface and superb performance specifications, DL3000 provides various interfaces for remote communication to meet your diversified test requirements.

- 150 V/40 A, 200W; 150 V/60 A, 350 W
- Dynamic mode: up to 30 kHz
- Adjustable current slew rate: 0.001 A/ μ s to 5 A/ μ s
- Min. readback resolution: 0.1 mV, 0.1 mA
- RS232, USB, and LAN interface

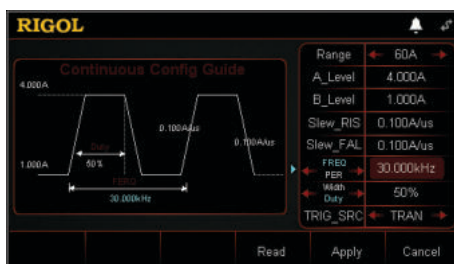

30 kHz dynamic mode

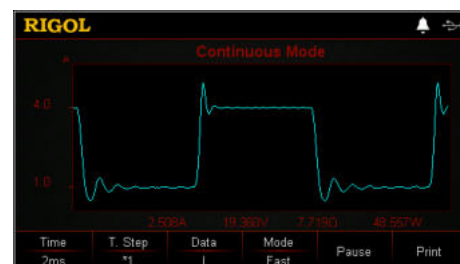

Powerful waveform display function

Models and Specifications

Model	DL3021		DL3021A		DL3031		DL3031A	
	Low Range	High Range	Low Range	High Range	Low Range	High Range	Low Range	High Range
Power	200 W				350 W			
Voltage	0 V to 150 V							
Current	0 A to 40 A				0 A to 60 A			
Minimum Operating Voltage (DC)	40 A@1 V				60 A@1.3 V			
CC Mode								
Range	0 A to 4 A	0 A to 40 A	0 A to 4 A	0 A to 40 A	0 A to 6 A	0 A to 60 A	0 A to 6 A	0 A to 60 A
Programming Resolution	1mA							
Programming Accuracy	±(0.05% + 0.05%FS)							
Programming Temperature Coefficient	100 ppm/°C							
CV Mode								
Range	0 V to 15 V	0 V to 150 V	0 V to 15 V	0 V to 150 V	0 V to 15 V	0 V to 150 V	0 V to 15 V	0 V to 150 V
Programming Resolution	1mV	5mV	1mV	5mV	1mV	5mV	1mV	5mV
Programming Accuracy	±(0.05% + 0.02%FS)	±(0.05% + 0.025%FS)	±(0.05% + 0.02%FS)	±(0.05% + 0.025%FS)	±(0.05% + 0.02%FS)	±(0.05% + 0.025%FS)	±(0.05% + 0.02%FS)	±(0.05% + 0.025%FS)
Programming Temperature Coefficient	50 ppm/°C							
CR Mode								
Range	0.08 Ω to 15 Ω	2 Ω to 15 kΩ	0.08 Ω to 15 Ω	2 Ω to 15 kΩ	0.08 Ω to 15 Ω	2 Ω to 15 kΩ	0.08 Ω to 15 Ω	2 Ω to 15 kΩ
Programming Resolution	2 mA/Vsense							
Programming Accuracy	Vin/Rset*(0.2%) + 0.2% IFS							
CP Mode								
Range	0 ~ 200 W				0 ~ 350 W			
Resolution	100 mW							
Continuous Mode (CC)								
Frequency Range	0.001 Hz to 15 kHz		0.001 Hz to 30 kHz		0.001 Hz to 15 kHz		0.001 Hz to 30 kHz	
Frequency Resolution	0.8%							
Frequency Accuracy	±0.5%							
Duty Cycle Range	5% to 95%, 1%							
Current Slew Rate								
Range	0.001 A/μs to 0.25 A/μs	0.001 A/μs to 2.5 A/μs (>5 V)	0.001 A/μs to 0.3 A/μs	0.001 A/μs to 3 A/μs (>5 V)	0.001 A/μs to 0.25 A/μs	0.001 A/μs to 2.5 A/μs (>5 V)	0.001 A/μs to 0.5 A/μs	0.001 A/μs to 5 A/μs (>5 V)

Model	DL3021	DL3021A	DL3031	DL3031A
Resolution	0.001 A/ μ s			
Accuracy	5%+10 μ s			
Current Readback				
Range	0 A to 40 A		0 A to 60 A	
Resolution	1mA	0.1mA	1mA	0.1mA
Accuracy	$\pm(0.05\% + 0.05\%FS)$			
Temperature Coefficient	50 ppm/ $^{\circ}C$			
Voltage Readback				
Range	0 V to 150 V			
Resolution	0.1mV			
Accuracy	$\pm(0.05\% + 0.02\%FS)$			
Temperature Coefficient	20 ppm/ $^{\circ}C$			
Protection Function	Overcurrent protection (OCP), overvoltage protection (OVP), overpower protection (OPP), overtemperature protection (OTP), and local/remote reverse voltage (LRV/RRV) protection			
Current	$\pm(0.01\% \pm 10 \text{ mA})$			
Voltage	$\pm(0.01\% \pm 10 \text{ mV})$			
Input Impedance	350 k Ω			
I/O				
USB DEVICE	•	•	•	•
USB HOST	•	•	•	•
RS232	•	•	•	•
LAN	○	•	○	•
Digital I/O	○	•	○	•
GPIB	○	○	○	○

Note: • Standard ○ Option

Order Information

	Description	Order No.
Model	DL3021 (Single-channel, DC150 V/40 A, 200 W, 15 kHz, 2.5 A/ μ s)	DL3021
	DL3021A (Single-channel, DC150 V/40 A, 200 W, 30 kHz, 3.0 A/ μ s)	DL3021A
	DL3031 (Single-channel, DC150 V/60 A, 350 W, 15 kHz, 2.5 A/ μ s)	DL3031
	DL3021A (Single-channel, DC150 V/60 A, 350 W, 30 kHz, 5.0 A/ μ s)	DL3031A

	Description	Order No.
Optional Accessories	LAN Interface	LAN-DL3
	Digital I/O Option	DIGITALIO-DL3
	Readback Resolution	HIRES-DL3
	High Frequency Option	FREQ-DL3
	High Slew Rate Option	SLEWRATE-DL3
	Terminal Shield	DL-02
	9-Pin RS232 Cable (female-to-female, cross-over)	CB-RS232-A
	USB-GPIB Adaptor	USB-GPIB
	Sense Cable	CB-SENSE
	20 A Red and Black Test Leads	CB-20A-780MM
	40 A Red and Black Test Leads	CB-40A-780MM
	60 A Red and Black Test Leads	CB-60A-780MM
	DL3000 Series Rack Mount Kit (for a single instrument)	RM-1-DP800
	DL3000 Series Rack Mount Kit (for two instruments)	RM-2-DP800

HEADQUARTER

RIGOL TECHNOLOGIES CO., LTD.
No.8 Keling Road, New District, Suzhou,
JiangSu, P.R.China
Tel: +86-400620002
Email: info@rigol.com

EUROPE

RIGOL TECHNOLOGIES EU GmbH
Carl-Benz-Str.11
82205 Gilching
Germany
Tel: +49(0)8105-27292-0
Email: info-europe@rigol.com

NORTH AMERICA

RIGOL TECHNOLOGIES, USA INC.
10220 SW Nimbus Ave.
Suite K-7
Portland, OR 97223
Tel: +1-877-4-**RIGOL**-1
Fax: +1-877-4-**RIGOL**-1
Email: info@rigol.com

JAPAN

RIGOL JAPAN CO., LTD.
5F,3-45-6,Minamiotsuka,
Toshima-Ku,
Tokyo,170-0005,Japan
Tel: +81-3-6262-8932
Fax: +81-3-6262-8933
Email: info-japan@rigol.com

RIGOL® is the trademark of **RIGOL TECHNOLOGIES CO., LTD.** Product information in this document is subject to update without notice. For the latest information about **RIGOL**'s products, applications and services, please contact local **RIGOL** channel partners or access **RIGOL** official website: www.rigol.com