

# **RIGOL**

## **Programming Guide**

### **M300 Series**

### **Data Acquisition/Switch System**

**Oct. 2021**  
**RIGOL TECHNOLOGIES CO., LTD.**



---

# Guaranty and Declaration

## Copyright

© 2021 **RIGOL** TECHNOLOGIES CO., LTD. All Rights Reserved.

## Trademark Information

**RIGOL**® is the trademark of **RIGOL** TECHNOLOGIES CO., LTD.

## Publication Number

PGC07107-1110

## Software Version

00.02.00.07.02

Software upgrade might change or add product features. Please acquire the latest version of the manual from **RIGOL** website or contact **RIGOL** to upgrade the software.

## Notices

- **RIGOL** products are covered by P.R.C. and foreign patents, issued and pending.
- **RIGOL** reserves the right to modify or change parts of or all the specifications and pricing policies at the company's sole decision.
- Information in this publication replaces all previously released materials.
- Information in this publication is subject to change without notice.
- **RIGOL** shall not be liable for either incidental or consequential losses in connection with the furnishing, use, or performance of this manual, as well as any information contained.
- Any part of this document is forbidden to be copied, photocopied, or rearranged without prior written approval of **RIGOL**.

## Product Certification

**RIGOL** guarantees that this product conforms to the national and industrial standards in China as well as the ISO9001:2015 standard and the ISO14001:2015 standard. Other international standard conformance certifications are in progress.

## Contact Us

If you have any problem or requirement when using our products or this manual, please contact **RIGOL**.

E-mail: [service@rigol.com](mailto:service@rigol.com)

Website: [www.rigol.com](http://www.rigol.com)

# Document Overview

## Main Contents in this Manual:

### Chapter 1 Programming Overview

This chapter introduces how to build the remote communication between the instrument and PC. Besides, it also provides an overview of the syntax, symbol, parameter type and abbreviation rules of the SCPI commands as well as the SCPI status system.

### Chapter 2 Command System

This chapter introduces the syntax, function, parameter and using instruction of each M300 command in A-Z order.

### Chapter 3 Application Examples

This chapter provides the application examples of the main functions of M300 Data Acquisition/Switch system. In the application examples, a series of commands are combined to realize the basic functions of the Data Acquisition/Switch system.

### Chapter 4 Programming Demos

This chapter introduces how to program and control M300 using various development tools, such as Visual Studio and LabVIEW.

### Chapter 5 Appendix

This chapter provides various information, such as the command list and factory setting list.

## User Documents of the Product:

The main user documents of the product include quick guide, user's guide, programming guide and data sheet. For the newest versions of these manuals, please download them from [www.rigol.com](http://www.rigol.com).

## Format Conventions in this Manual:

### 1 Key

The function key at the front panel is denoted by the format of "Key Name (Bold) + Text Box" in the manual. For example, **Utility** denotes the Utility key.

### 2 Menu

The menu item is denoted by the format of "Menu Word (Bold) + Character Shading" in the manual. For example, **System** denotes the System menu under **Utility**.

### 3 Operation Step

The next step of the operation is denoted by an arrow "→" in the manual. For example, **Utility** → **System** denotes pressing **Utility** at the front panel and then pressing **System**.

### 4 Slot

The 5 slots are denoted by Slot1, Slot2, Slot3, Slot4 and Slot5 in the manual, wherein 1 to 5 denote the slot numbers.

### 5 Channel

The channel is denoted by SCC in the manual, wherein S (ranges from 1 to 5) denotes the slot number of the module and CC (ranges from 01 to 64) denotes the channel number.

## 6 Module

The definitions of the modules and their numbers are as shown in the table below. Unless otherwise noted, "Multiplexer channels" refers to the MC3120, MC3120A, MC3132, MC3164 and MC3324 channels.

Model	Name	Explanation
MC3065	DMM Module	Measure signals under test and perform statistical calculations on the measurement results.
MC3120	20-Channel Multiplexer	Support DCV, ACV, TEMP, FREQ, PERIOD and SENSOR measurement functions; support scaling and alarm functions.
MC3132	32-Channel Multiplexer	Support DCV, ACV, TEMP, FREQ, PERIOD and SENSOR measurement functions; support scaling and alarm functions.
MC3164	64-Single-Ended Multiplexer	Support DCV, ACV, TEMP, FREQ, PERIOD and SENSOR measurement functions; support scaling and alarm functions.
MC3324	24-Channel Multiplexer	Support DCV, ACV, DCI, ACI, TEMP, FREQ, PERIOD and SENSOR measurement functions; support scaling and alarm functions.
MC3416	16-Channel Actuator	Switch signal to the device under test or actuate external devices.
MC3534	Multifunction Module	Channel 1 to Channel 4 are the DIO (Digital Input/Output) channels; Channel 5 to Channel 8 are the TOT (Totalizer) channels; Channel 9 to Channel 12 are the DAC (Digital-to-Analog Converter) channels.
MC3648	4×8 Matrix Switch	Connect multiple devices to multiple channels on the device under test.

# Contents

<b>Guaranty and Declaration</b> .....	<b>I</b>
<b>Document Overview</b> .....	<b>II</b>
<b>Chapter 1 Programming Overview</b> .....	<b>1-1</b>
To Build Remote Communication .....	1-2
Remote Control Methods .....	1-4
SCPI Command Overview .....	1-5
Syntax .....	1-5
Symbol Description .....	1-5
Parameter Type .....	1-6
Command Abbreviation .....	1-7
SCPI Status System .....	1-8
<b>Chapter 2 Command System</b> .....	<b>2-1</b>
ABORT .....	2-2
CALCulate Command Subsystem .....	2-3
CALCulate:AVERage:AVERage? .....	2-4
CALCulate:AVERage:MAXimum? .....	2-4
CALCulate:AVERage:MINimum? .....	2-4
CALCulate:AVERage:PTPeak? .....	2-4
CALCulate:AVERage:SDEV? .....	2-4
CALCulate:AVERage:CLEar .....	2-5
CALCulate:AVERage:COUNt? .....	2-6
CALCulate:AVERage:MAXimum:TIME? .....	2-7
CALCulate:AVERage:MINimum:TIME? .....	2-7
CALCulate:COMPare:DATA .....	2-8
CALCulate:COMPare:MASK .....	2-9
CALCulate:COMPare:STATE .....	2-10
CALCulate:COMPare:TYPE .....	2-11
CALCulate:LIMit:LOWer .....	2-12
CALCulate:LIMit:UPPer .....	2-12
CALCulate:LIMit:LOWer:STATE .....	2-13
CALCulate:LIMit:UPPer:STATE .....	2-13
CALCulate:SCALE:SQUare .....	2-14
CALCulate:SCALE:GAIN .....	2-14
CALCulate:SCALE:OFFSet .....	2-14
CALCulate:SCALE:CONStant .....	2-14
CALCulate:SCALE:OFFSet:NULL .....	2-15
CALCulate:SCALE:STATE .....	2-16
CALCulate:SCALE:UNIT .....	2-17
CONFigure Command Subsystem .....	2-19
CONFigure? .....	2-20
CONFigure:ANYSensor .....	2-21
CONFigure:COPY:CH:CH .....	2-22
CONFigure:COPY:CH:SLOT .....	2-23
CONFigure:COPY:SLOT:SLOT .....	2-24
CONFigure:CURRent:AC .....	2-24
CONFigure:CURRent[:DC] .....	2-26
CONFigure:DIGital:BYTE .....	2-28
CONFigure:DIGital:DWORd .....	2-28
CONFigure:DIGital:WORd .....	2-28
CONFigure:FREQuency .....	2-29
CONFigure:PERiod .....	2-29
CONFigure:FRESistance .....	2-30
CONFigure:RESistance .....	2-30

CONFigure:TEMPerature .....	2-32
CONFigure:TOTalize .....	2-33
CONFigure:VOLTage:AC .....	2-34
CONFigure:VOLTage[:DC] .....	2-35
DATA Command Subsystem.....	2-38
DATA:LAST?.....	2-38
DATA:POINts? .....	2-39
DATA:POINts:EVENT:THReshold .....	2-39
DATA:REMOve? .....	2-40
DIAGnostic Command Subsystem .....	2-41
DIAGnostic:DMM:CYCLes? .....	2-41
DIAGnostic:DMM:CYCLes:CLEar .....	2-41
DIAGnostic:PEEK:SLOT:DATA? .....	2-42
DIAGnostic:POKE:SLOT:DATA.....	2-42
DIAGnostic:RELAy:CYCLes?.....	2-42
DIAGnostic:RELAy:CYCLes:CLEar .....	2-43
DISPlay Command Subsystem .....	2-44
DISPlay .....	2-44
DISPlay:TEXT .....	2-45
DISPlay:TEXT:CLEar .....	2-45
FETCh? .....	2-46
FORMat Command Subsystem.....	2-47
FORMat:READing:ALARm.....	2-48
FORMat:READing:CHANnel .....	2-48
FORMat:READing:TIME .....	2-49
FORMat:READing:TIME:TYPE.....	2-49
FORMat:READing:UNIT .....	2-50
IEEE-488.2 Common Commands .....	2-51
*CLS .....	2-51
*ESE .....	2-52
*ESR? .....	2-53
*IDN? .....	2-53
*OPC.....	2-54
*PSC .....	2-54
*RST .....	2-54
*SAV .....	2-55
*RCL .....	2-55
*SRE .....	2-56
*STB? .....	2-57
*TRG.....	2-57
*WAI.....	2-58
INITiate .....	2-59
INPut:IMPedance:AUTO .....	2-60
INSTrument Command Subsystem.....	2-61
INSTrument:DMM .....	2-61
INSTrument:DMM:INSTalled? .....	2-61
LXI Command Subsystem.....	2-62
LXI:IDENtify[:STATE] .....	2-62
LXI:RESet.....	2-62
LXI:REStart .....	2-62
MEASure Command Subsystem .....	2-63
MEASure:ANYSensor?.....	2-63
MEASure:CURR:AC? .....	2-64
MEASure:CURR[:DC]? .....	2-65
MEASure:DIGital:BYTE?.....	2-66
MEASure:DIGital:DWORD?.....	2-66
MEASure:DIGital:WORD?.....	2-66
MEASure:FREQUency? .....	2-67

MEASure:PERiod?	2-67
MEASure:TEMPerature?	2-68
MEASure:TOTalize?	2-69
MEASure:VOLTage:AC?	2-69
MEASure:VOLTage[:DC]?	2-70
MEMory Command Subsystem	2-72
MEMory:NStates?	2-72
MEMory:SAVE:SYSTem	2-73
MEMory:NAME:SYSTem?	2-73
MEMory:RECall:SYSTem	2-73
MEMory:SAVE:CONFig	2-74
MEMory:NAME:CONFig?	2-74
MEMory:RECall:CONFig	2-74
MEMory:SAVE:MIRRor	2-75
MEMory:NAME:MIRRor?	2-75
MEMory:RECall:MIRRor	2-75
MEMory:SAVE:DATA	2-76
MEMory:NAME:DATA?	2-76
MEMory:RECall:DATA	2-76
MEMory:STATe:DELeTe	2-77
MEMory:STATe:NAME	2-77
MEMory:STATe:RECall	2-78
MEMory:STATe:VALid?	2-79
MMEMory Command Subsystem	2-80
MMEMory:EXPort?	2-80
MMEMory:FORMat:READing:CSEParator	2-81
MMEMory:FORMat:READing:RLIMit	2-81
MMEMory:IMPort:CATalog?	2-82
MMEMory:IMPort:CONFig?	2-82
MMEMory:LOG[:ENABLE]	2-83
OUTPut Command Subsystem	2-84
OUTPut:ALARm<n>:CLEar	2-84
OUTPut:ALARm:CLEar:ALL	2-84
OUTPut:ALARm<n>:ENABLE?	2-84
OUTPut:ALARm[<n>]:MODE	2-85
OUTPut:ALARm[<n>]:SLOPe	2-86
OUTPut:ALARm<n>:SOURce	2-87
R?	2-88
READ?	2-89
ROUTe Command Subsystem	2-90
ROUTe:CHANnel:ADVance:SOURce	2-90
ROUTe:CHANnel:ADVance:EDGE	2-91
ROUTe:CHANnel:DELay	2-92
ROUTe:CHANnel:DELay:AUTO	2-93
ROUTe:CHANnel:FWIRe	2-94
ROUTe:CLOSe	2-95
ROUTe:CLOSe:EXCLusive	2-96
ROUTe:DONE?	2-96
ROUTe:MONitor[:CHAN]	2-97
ROUTe:MONitor:DATA?	2-98
ROUTe:MONitor:DATA:FULL?	2-98
ROUTe:MONitor:STATe	2-99
ROUTe:OPEN	2-100
ROUTe:SCAN	2-101
ROUTe:SCAN:SIZE?	2-102
SENSe Command Subsystem	2-103
[SENSe:]ANYSensor:FREQUency:RANGe:LOWer	2-104
[SENSe:]ANYSensor:VOLTage:APERture	2-105



[SENSe:]ANYSensor:VOLTage:NPLC .....	2-106
[SENSe:]ANYSensor:CURRent:APERTure .....	2-107
[SENSe:]ANYSensor:CURRent:NPLC .....	2-108
[SENSe:]ANYSensor:SEGMENT .....	2-109
[SENSe:]ANYSensor:SEGMENT:CLEar .....	2-110
[SENSe:]ANYSensor:TYPE .....	2-111
[SENSe:]CURRent:AC:BANDwidth .....	2-112
[SENSe:]CURRent:AC:RANGe .....	2-113
[SENSe:]CURRent[:DC]:RANGe .....	2-113
[SENSe:]CURRent:AC:RANGe:AUTO .....	2-114
[SENSe:]CURRent[:DC]:RANGe:AUTO .....	2-114
[SENSe:]CURRent:AC:RESolution .....	2-115
[SENSe:]CURRent[:DC]:APERTure .....	2-116
[SENSe:]CURRent[:DC]:NPLC .....	2-117
[SENSe:]CURRent[:DC]:RESolution .....	2-118
[SENSe:]DIGital:DATA[:BYTE]? .....	2-119
[SENSe:]DIGital:DATA:WORD? .....	2-119
[SENSe:]DIGital:DATA:DWORD? .....	2-119
[SENSe:]DIGital:TYPE .....	2-120
[SENSe:]DIGital:LEVel .....	2-121
[SENSe:]DIGital:THReshold .....	2-122
[SENSe:]FREQuency:APERTure .....	2-123
[SENSe:]PERiod:APERTure .....	2-123
[SENSe:]FREQuency:RANGe:LOWer .....	2-124
[SENSe:]PERiod:RANGe:LOWer .....	2-124
[SENSe:]FREQuency:VOLTage:RANGe .....	2-125
[SENSe:]PERiod:VOLTage:RANGe .....	2-125
[SENSe:]FREQuency:VOLTage:RANGe:AUTO .....	2-126
[SENSe:]PERiod:VOLTage:RANGe:AUTO .....	2-126
[SENSe:]FUNction .....	2-127
[SENSe:]TEMPerature:APERTure .....	2-128
[SENSe:]TEMPerature:NPLC .....	2-129
[SENSe:]TEMPerature:RJUNction? .....	2-130
[SENSe:]TEMP:TRANSDucer:FRTD:OCOMPensated .....	2-130
[SENSe:]TEMP:TRANSDucer:RTD:OCOMPensated .....	2-130
[SENSe:]TEMPerature:TRANSDucer:FRTD:RESistance[:REFerence] .....	2-131
[SENSe:]TEMPerature:TRANSDucer:RTD:RESistance[:REFerence] .....	2-131
[SENSe:]TEMPerature:TRANSDucer:FRTD:TYPE .....	2-133
[SENSe:]TEMPerature:TRANSDucer:RTD:TYPE .....	2-133
[SENSe:]TEMPerature:TRANSDucer:TCouple:CHECK .....	2-134
[SENSe:]TEMPerature:TRANSDucer:TCouple:RJUNction:TYPE .....	2-134
[SENSe:]TEMPerature:TRANSDucer:TCouple:RJUNction .....	2-136
[SENSe:]TEMPerature:TRANSDucer:TCouple:TYPE .....	2-136
[SENSe:]TEMPerature:TRANSDucer:THERmistor:TYPE .....	2-137
[SENSe:]TEMPerature:TRANSDucer:TYPE .....	2-138
[SENSe:]TOTAlize:CLEar:IMMEDIATE .....	2-139
[SENSe:]TOTAlize:DATA? .....	2-139
[SENSe:]TOTAlize:SLOPe .....	2-140
[SENSe:]TOTAlize:START[:IMMEDIATE] .....	2-141
[SENSe:]TOTAlize:START:DEFault .....	2-141
[SENSe:]TOTAlize:STOP[:IMMEDIATE] .....	2-142
[SENSe:]TOTAlize:STOP:DEFault .....	2-142
[SENSe:]TOTAlize:TYPE .....	2-143
[SENSe:]TOTAlize:THReshold .....	2-144
[SENSe:]VOLTage:AC:RANGe .....	2-145
[SENSe:]VOLTage[:DC]:RANGe .....	2-145
[SENSe:]VOLTage:AC:RANGe:AUTO .....	2-146
[SENSe:]VOLTage[:DC]:RANGe:AUTO .....	2-146

[SENSe:]VOLTagE:AC:BANDwidth .....	2-147
[SENSe:]VOLTagE:AC:RESolution .....	2-148
[SENSe:]VOLTagE[:DC]:APERture .....	2-149
[SENSe:]VOLTagE[:DC]:NPLC .....	2-150
[SENSe:]VOLTagE[:DC]:RESolution .....	2-151
[SENSe:]ZERO:AUTO .....	2-152
SOURce Command Subsystem .....	2-153
SOURce:DIGital:DATA[:BYTE] .....	2-153
SOURce:DIGital:DATA:DWORd .....	2-153
SOURce:DIGital:DATA:WORd .....	2-153
SOURce:DIGital:STATe? .....	2-154
SOURce:VOLTagE .....	2-155
STATus Command Subsystem .....	2-156
STATus:ALARm:CONDition? .....	2-156
STATus:ALARm:ENABle .....	2-157
STATus:ALARm[:EVENT]? .....	2-158
STATus:OPERation:CONDition? .....	2-158
STATus:OPERation:ENABle .....	2-159
STATus:OPERation[:EVENT]? .....	2-160
STATus:PRESet .....	2-161
STATus:QUESTionable:CONDition? .....	2-161
STATus:QUESTionable:ENABle .....	2-162
STATus:QUESTionable[:EVENT]? .....	2-163
SYSTem Command Subsystem .....	2-164
SYSTem:ALARm? .....	2-165
SYSTem:ANALog:OUTPut:SWITCh .....	2-166
SYSTem:COMMunicate:GPIB:ADDRes .....	2-166
SYSTem:COMMunicate:LAN:AUTOip .....	2-167
SYSTem:COMMunicate:LAN:CONTRol? .....	2-167
SYSTem:COMMunicate:LAN:DHCP .....	2-168
SYSTem:COMMunicate:LAN:DNS .....	2-168
SYSTem:COMMunicate:LAN:GATEway .....	2-169
SYSTem:COMMunicate:LAN:IPADdress .....	2-170
SYSTem:COMMunicate:LAN:MAC? .....	2-170
SYSTem:COMMunicate:LAN:MANUip .....	2-171
SYSTem:COMMunicate:LAN:TELNet:PRoMpt .....	2-171
SYSTem:COMMunicate:LAN:TELNet:WMESsage .....	2-171
SYSTem:COMMunicate:LAN:SMASk .....	2-172
SYSTem:COMMunicate:LAN:UPDate .....	2-173
SYSTem:COMMunicate:RS232:BAUD .....	2-173
SYSTem:COMMunicate:RS232:FLOWcontrol .....	2-174
SYSTem:COMMunicate:RS232:PARItY .....	2-175
SYSTem:COMMunicate:RS232:PRINt:STATe .....	2-175
SYSTem:CPON .....	2-176
SYSTem:CTYPE:DEFine .....	2-176
SYSTem:CTYPE:DEFault .....	2-177
SYSTem:CTYPE? .....	2-178
SYSTem:DATE .....	2-179
SYSTem:EDITION? .....	2-179
SYSTem:ERRor? .....	2-179
SYSTem:IDN:USER:DEFine .....	2-180
SYSTem:IDN:DEFault .....	2-180
SYSTem:LFRequency? .....	2-181
SYSTem:LOCAl .....	2-181
SYSTem:OPENTimes? .....	2-181
SYSTem:PRESet .....	2-182
SYSTem:REMOte .....	2-182
SYSTem:RWLock .....	2-182

SYSTem:SECurity[:IMMediate] .....	2-182
SYSTem:SERIal?.....	2-183
SYSTem:TIME .....	2-183
SYSTem:TIME:SCAN? .....	2-184
SYSTem:TYPE?.....	2-184
SYSTem:UTIlity:BEEPer:STATe .....	2-184
SYSTem:UTIlity:CARDoPeration.....	2-185
SYSTem:UTIlity:CONFIgure:POWEron .....	2-185
SYSTem:UTIlity:DISPly:BRIGht.....	2-186
SYSTem:UTIlity:FORMat:DECImal .....	2-186
SYSTem:UTIlity:FORMat:SEPARate.....	2-187
SYSTem:UTIlity:LANGUage.....	2-187
SYSTem:UTIlity:POWEr:SWITCh:STATe .....	2-187
SYSTem:UTIlity:SAVEr:STATe .....	2-188
SYSTem:UTIlity:SAVEr:TIME .....	2-188
SYSTem:VERSion?.....	2-189
TRIGger Command Subsystem .....	2-190
TRIGger:ABSolute .....	2-190
TRIGger:COUNT .....	2-191
TRIGger:EDGE .....	2-192
TRIGger:SOURce .....	2-193
TRIGger:TIMer .....	2-194
UNIT Command Subsystem.....	2-195
UNIT:ANYSensor .....	2-195
UNIT:TEMPerature .....	2-196
<b>Chapter 3 Application Examples .....</b>	<b>3-1</b>
Scan List Configuration.....	3-2
To Configure the Channels.....	3-2
To Configure the Scan List .....	3-9
Monitor .....	3-9
Store and Recall .....	3-11
Store and Recall in Internal Memory.....	3-11
To Store System Configuration and Scan Data in the USB Storage Device .....	3-11
To Import the .blcfg File from the USB Storage Device .....	3-12
Copy .....	3-13
Channel Copy .....	3-13
Extended Copy.....	3-13
Module Copy.....	3-14
To Output Digital Signal .....	3-15
To Output Analog Voltage.....	3-15
<b>Chapter 4 Programming Demos.....</b>	<b>4-1</b>
Programming Preparations .....	4-2
LabVIEW Programming Demo.....	4-3
C++ Programming Demo .....	4-14
C# Programming Demo.....	4-24
<b>Chapter 5 Appendix.....</b>	<b>5-1</b>
Appendix A: Factory Settings .....	5-1
Appendix B: Instrument Preset State .....	5-3
Appendix C: Non-volatile Memory .....	5-5
Appendix D: Volatile Memory .....	5-5
Appendix E: Module Schematic Diagram.....	5-6
Appendix F: Command List.....	5-10
Appendix G: Warranty.....	5-18



# Chapter 1 Programming Overview

This chapter introduces how to build the remote communication between the PC and instrument and provides an overview of the syntax, symbol, parameter type and abbreviation rules of the SCPI commands as well as the SCPI status system.

## Main topics of this chapter:

- [To Build Remote Communication](#)
- [Remote Control Methods](#)
- [SCPI Command Overview](#)
- [SCPI Status System](#)

## To Build Remote Communication

You can build the remote communication between M300 and PC over USB, LAN, RS232 or GPIB (IEEE-488) interface.

### Operation Steps:

#### 1 Install the Ultra Sigma common PC software

Download the Ultra Sigma common PC software from [www.rigol.com](http://www.rigol.com) and install it according to the instructions.

#### 2 Connect the instrument and PC and configure the interface parameters of the instrument

M300 supports USB, LAN, RS232 and GPIB (IEEE-488) communication interfaces, as shown in the figure below.

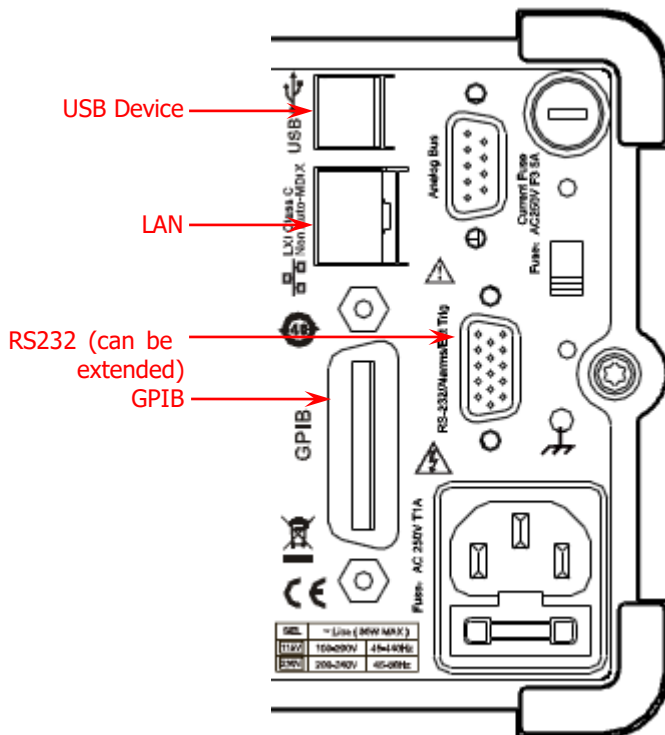

Figure 1-1 M300 Communication Interfaces

- (1) Use the USB interface:
  - Connect the USB Device interface at the rear panel of M300 and the USB Host interface of the PC using a USB cable.
- (2) Use the LAN interface:
  - Connect the instrument to your PC or the network of your PC using a network cable.
  - Check whether your network supports the DHCP or auto IP mode. If not, you need to enable the manual IP mode, disable the DHCP mode and auto IP mode and acquire the network interface parameters available (include the IP address, subnet mask, gateway and DNS) from your network administrator.
  - Manually configure the IP address, subnet mask, default gateway, and DNS of the instrument.
- (3) Use the RS232 interface:
  - Use the mixed interface convert cable to convert the **[RS232/Alarms/Ext Trig]** interface at the rear panel into two 9-pin interfaces, wherein one is a 9-pin male connector used as a standard RS232 interface, the other is a 9-pin female connector for alarm output and external trigger signal input, etc.
  - Connect the RS232 interface with the PC or data terminal equipment (DTE) using a RS232

- cable. Press **Utility** → **I/O** → **RS232**, select **Print** and then select "No" to deisable the measurement data print function of the RS232 interface.
- Set interface parameters (baud rate, flow control and etc) which match the PC or terminal equipment.

(4) Use the GPIB interface:

- Connect the instrument with your PC (GPIB card is installed) using a GPIB cable.
- Press **Utility** → **I/O** → **GPIB** to set the GPIB address of the instrument.

### 3 Check whether the connection is successful

Run the Ultra Sigma, search for resource, right-click the resource name and select "SCPI Panel Control" in the pop-up menu. Enter the correct command in the pop-up SCPI control panel and click **Send Command**, **Read Response** or **Send&Read** to check whether the connection is successful, as shown in the figure below (take the USB interface as an example).

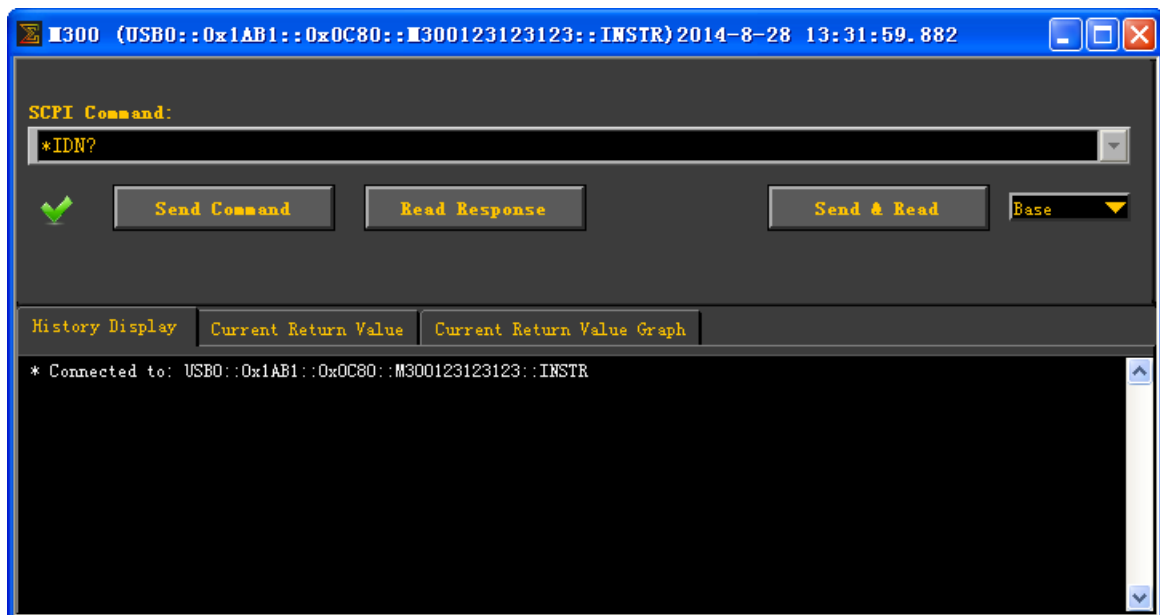

## Remote Control Methods

### 1. Send SCPI Commands via the PC Software

You are recommended to control M300 Data Acquisition/Switch System remotely by sending SCPI commands via the PC software (Ultra Sigma) provided by **RIGOL**.

### 2. User-defined Programming

You can program and control the instrument using the SCPI (Standard Commands for Programmable Instruments) commands listed in chapter 2 [Command System](#) in various development environments (such as Visual Studio and LabVIEW). For details, refer to the introductions in chapter 4 [Programming Demos](#).



## SCPI Command Overview

SCPI (Standard Commands for Programmable Instruments) is a standardized instrument programming language that is built upon the standard IEEE488.1 and IEEE 488.2 and conforms to various standards (such as the floating point operation rule in IEEE754 standard, ISO646 7-bit coded character for information interchange (equivalent to ASCII programming)). This section introduces the syntax, symbols, parameters and abbreviation rules of the SCPI commands.

### Syntax

SCPI commands present a hierarchical tree structure and contain multiple sub-systems, each of the commands consists of a root keyword and one or more sub-keywords. The keywords are separated by ":" and are followed by the parameter settings available; "?" is added at the end of the command string to indicate query; the command and parameter are separated by space.

For example,

[CALCulate:LIMit:LOWer:STATe <mode>,@<ch list>](#)

[CALCulate:LIMit:LOWer:STATe? \(@<ch list>\)](#)

CALCulate is the root keyword of the command. LIMit, LOWer and STATe are the second-level, third-level and fourth level keywords respectively. The multiple-level keywords were separated by ":". <mode> represents the parameter available for setting. "?" represents query. The command CALCulate:LIMit:LOWer:STATe and parameter <mode> are separated by space. The parameters <mode> and (@<ch list>) are separated by comma. The command CALCulate:LIMit:LOWer:STATe? and the parameter (@<ch list>) are separated by space. "," is generally used for separating multiple parameters contained in the same command, for example, [SYSTem:DATE <yyyy>,<mm>,<dd>](#).

### Symbol Description

The following four symbols are not the content of SCPI commands and will not be sent with the commands. They are usually used to describe the parameters in the commands.

#### 1. Braces { }

The contents enclosed in the braces are always parameters to be selected and one of the parameters must be selected when sending the command. For example, the [CONFigure:CURRent:AC \[ <range>|AUTO|MIN|MAX|DEF \], { <resolution>|MIN|MAX|DEF }, \(@<scan list>\)](#) command.

#### 2. Vertical Bar |

The vertical bar is used to separate multiple parameters and one of the parameters must be selected when sending the command. For example, in the [DISPlay OFF|0|ON|1](#) command, "OFF", "ON", "0" and "1" are the optional parameters and one of them must be selected.

#### 3. Square Brackets [ ]

The content (command keyword) enclosed in the square brackets can be omitted. When the parameter is omitted, the instrument will set the parameter to its default. For example, for the [\[SENSe:\]CURRent\[:DC\]:APERTure { <time>|MIN|MAX }, \(@<ch list>\)](#) command, sending any of the four commands below can achieve the same effect.

```
[SENSe:]CURRent[:DC]:APERTure {<time>|MIN|MAX},{(@<ch_list>)}
[SENSe:]CURRent:APERTure {<time>|MIN|MAX},{(@<ch_list>)}
CURRent[:DC]:APERTure {<time>|MIN|MAX},{(@<ch_list>)}
CURRent:APERTure {<time>|MIN|MAX},{(@<ch_list>)}
```

#### 4. Triangle Brackets < >

The parameter enclosed in the triangle brackets must be replaced by an effective value. For example, send the [SYSTem:UTIlity:DISPlay:BRIGht <value>](#) command in SYSTem:UTIlity:DISPlay:BRIGht 5 form.

## Parameter Type

The parameters of the commands introduced in this manual contains 7 types: Scan list/Channel list/Channel, bool, integer, discrete, numeric, ASCII character string and filename.

### 1. Scan list/Channel list/Channel

The scan list parameter can be one or more channels. For example, in the [CONFigure:CURRent:AC{<range>|AUTO|MIN|MAX|DEF}{,<resolution>|MIN|MAX|DEF},\[@<scan\\_list>\]](#) command, the parameter (@<scan\_list>) can be (@301:302,215) (representing channel 01 through 02 on the module in Slot3 and channel 15 on the module in Slot2), (@201) (representing channel 01 on the module in Slot2) or (@101:112) (representing channel 01 through 12 on the module in Slot1). This parameter will reset the current scan list.

The channel list parameter can be one or more channels. For example, in the [\[SENSe:\]VOLTage\[:DC\]:NPLC {<PLCs>|MIN|MAX}{,\(@<ch\\_list>\)}](#) command, the parameter (@<ch\_list>) can be (@301:302,215) (representing channel 01 through 02 on the module in Slot3 and channel 15 on the module in Slot2), (@201) (representing channel 01 on the module in Slot2) or (@101:112) (representing channel 01 through 12 on the module in Slot1). The current scan list will not be affected by this parameter.

The channel parameter can only be a single channel. For example, in the [CONFigure:COpy:CH:SLOT \(@<channel>\),<slot>](#) command, the parameter <channel> can be (@213) (representing channel 13 on the module in Slot2). The current scan list will not be affected by this parameter.

### 2. Bool

The parameter can be OFF, ON, 0 or 1. For example, [DISPlay OFF|0|ON|1](#).

### 3. Integer

Unless otherwise noted, the parameter can be any integer within the effective value range. Note that do not set the parameter to a decimal; otherwise, errors will occur. For example, in the [SYSTem:UTIlity:DISPlay:BRIGht <value>](#) command, <value> can be any integer from 0 to 15.

### 4. Discrete

The parameter can only be one of the specified values or characters. For example, in the [OUTPut:ALARm\[<n>\]:MODE {LATCh|TRACk}](#) command, the parameter can be LATCh or TRACk.

### 5. Numeric

Unless otherwise noted, the parameter can be any real number within the effective value range. For example, the range of <time> in the [\[SENSe:\]CURRent\[:DC\]:APERture{<time>|MIN|MAX}{,\(@<ch\\_list>\)}](#) command is from 33 μs to 4s.

### 6. ASCII Character String

The parameter should be the combinations of ASCII characters. For example, in the [CALCulate:SCALE:UNIT <quoted\\_string>\[,\(@<ch\\_list>\)\]](#) command, <quoted\_string> is the unit of the scaling parameter and can include English characters and numbers.

### 7. Filename

The parameter represents the file name. The range of the parameter differs for the file with different extension. The parameter can include English letters, Chinese characters, underline and numbers. For details, please refer to the parameter description of the specific command.

## Command Abbreviation

All the commands are case-insensitive and you can use any of them. If abbreviation is used, all the capital letters in the command must be written completely. For example, the [CALCulate:AVERage:SDEV? \(@201\)](#) command can be abbreviated to [CALC:AVER:SDEV? \(@201\)](#).

## SCPI Status System

This chapter introduces the SCPI status system of M300.

M300 status system is shown in Figure 1-2. The five register groups are used to record a variety of conditions and status of the instrument. Each register group contains multiple underlying registers (condition register, event register and enable register).

- **Condition register**

The condition register monitors the instrument status continuously and the status of each bit is updated in real time. The condition register is read-only and the bits will not be cleared when you read the register. It returns a decimal value corresponding to the sum of the binary weights of all the bits in the register when you query the condition register.

- **Event register**

The event register latches the various events from the condition register. If the bit corresponding to an event is set to 1, the subsequent events will be ignored. The event register is read-only. Once a bit is set to 1, it remains set until cleared by a query command (such as [\\*ESR?](#)) or the [\\*CLS](#) command. It returns a decimal value corresponding to the sum of the binary weights of all the bits in the register when you query the event register.

- **Enable register**

The enable register defines whether to report the event in the event register to the status byte register group or not. The enable register could be read and written. You can use the [STATus:PRESet](#) command to clear all the bits in the enable register and use the [\\*PSC 1](#) command to configure the instrument to clear all the bits in the enable register at power-on. To enable the bits in the enable register, write a decimal value corresponding to the sum of the binary weights of all the bits in the enable register.

- **The Status Byte Register**

The status byte register group reports the events from other register groups. For example, the system error is reported to bit2 (Error generate). Clearing the event register of the relative register group will clear the corresponding bits in the condition register of the status byte register group. For example, clearing the error queue will clear bit2 (Error generate) in the condition register of the status byte register group. The bit definitions of the status byte register are as follows.

Bit	Weight	Name	Explanation
7	128	Operation Status Summary	One or more bits are set in the operation status register (the bits must be enabled, refer to the <a href="#">STATus:OPERation:ENABLE</a> command).
6	64	Master Summary	One or more bits are set in the status byte register.
5	32	Standard Event Status Summary	One or more bits are set in the standard event status register (the bits must be enabled, refer to the <a href="#">*ESE</a> command).
4	16	Message Available	Data is available in the output buffer.
3	8	Questionable Status Summary	One or more bits are set in the questionable status register (the bits must be enabled, refer to the <a href="#">STATus:QUESTionable:ENABLE</a> command).
2	4	Error Queue	One or more errors have been stored in the Error Queue.
1	2	Alarm Summary	One or more bits are enabled in the alarm register (the bits must be enabled, refer to the <a href="#">STATus:ALARm:ENABLE</a> command).
0	Not Used	Not Used	Always be 0.

The status byte condition register is cleared when:

- ✧ Send the [\\*CLS](#) command.
- ✧ Read the event register from the relative register group (only the corresponding bits in the event register of the relative register group are cleared).

The status byte enable register is cleared when:

- ✧ Send the [\\*SRE 0](#) command.
- ✧ The status byte enable register will be cleared when restarting the instrument after sending the [\\*PSC 1](#) command to set the instrument to clear all the bits in the enable register at power-on. On the contrary, the status byte enable register will not be cleared when restarting the instrument after sending the [\\*PSC 0](#) command to set the instrument to not clear all the bits in the enable register at power-on.

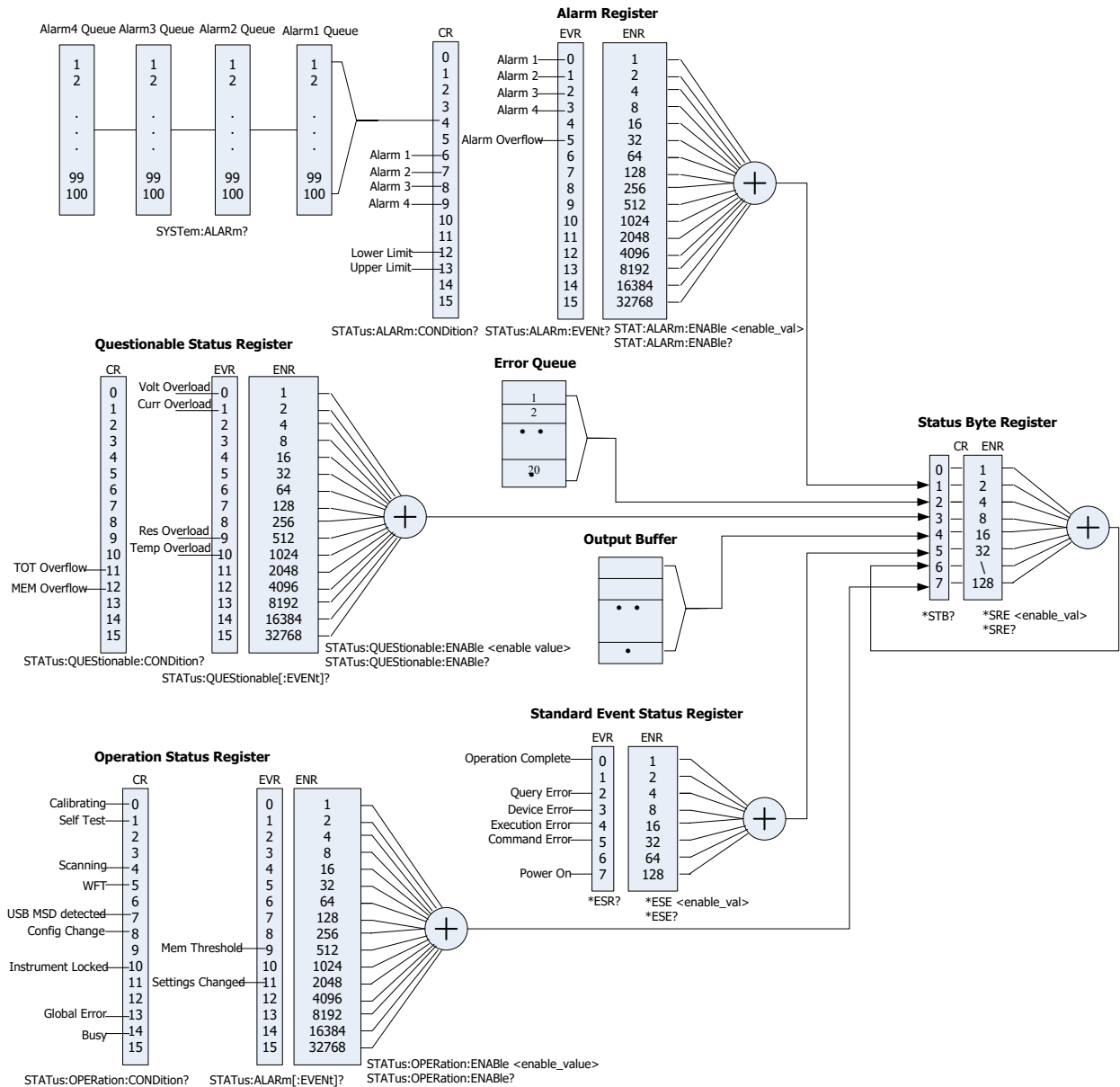

Figure 1-2 M300 Status System Structure Diagram



## Chapter 2 Command System

This chapter introduces the syntax, function, parameter and using instruction of each M300 command in A-Z order.

### Main topics of this chapter:

- [ABORT](#)
- [CALCulate Command Subsystem](#)
- [CONFigure Command Subsystem](#)
- [DATA Command Subsystem](#)
- [DIAGnostic Command Subsystem](#)
- [DISPlay Command Subsystem](#)
- [FETCh?](#)
- [FORMat Command Subsystem](#)
- [IEEE-488.2 Common Commands](#)
- [INITiate](#)
- [INPut:IMPedance:AUTO](#)
- [INSTrument Command Subsystem](#)
- [LXI Command Subsystem](#)
- [MEASure Command Subsystem](#)
- [MEMory Command Subsystem](#)
- [MMEMory Command Subsystem](#)
- [OUTPut Command Subsystem](#)
- [R?](#)
- [READ?](#)
- [ROUTE Command Subsystem](#)
- [SENSe Command Subsystem](#)
- [SOURce Command Subsystem](#)
- [STATus Command Subsystem](#)
- [SYSTem Command Subsystem](#)
- [TRIGger Command Subsystem](#)
- [UNIT Command Subsystem](#)

### Note:

M300 provides a set of standard values for setting some parameters, such as the range, resolution and integration time. When the parameter value sent is not one of the standard values, M300 will set the parameter according to the "Using the greater value principle" or "Using the smaller value principle" (no error will be generated).

- **Using the greater value principle:** if the specified value is different from the standard value of this parameter, the first standard value of this parameter that is greater than the specified value will be selected for this parameter.
- **Using the smaller value principle:** if the specified value is different from the standard value of this parameter, the first standard value of this parameter that is smaller than the specified value will be selected for this parameter.

## ABORT

**Syntax** ABORT

**Description** Abort the current measurement and stop the scan.

- Explanation**
- The instrument stops the current scan when receiving this command and the scan cannot be resumed. All the previous readings will be cleared when you initiate a new scan.
  - The [\\*RST](#) command will abort the current measurement, clear the scan list, and set all the measurement parameters to their factory settings.
  - The [SYSTem:PRESet](#) command can also abort the current measurement but it will not clear the scan list.

**Example** ABOR



## CALCulate Command Subsystem

M300 supports the scaling function and alarm function. You can configure the scaling parameters and alarm parameters for the channels in scan list. The DMM module stores the measurement readings and performs statistical calculations during the scan process. You can query the statistical calculation results at any time (even during a scan). The CALCulate commands are mainly used to set the alarm parameters and scaling parameters as well as query the statistical calculation results.

- [CALCulate:AVERage:AVERage?](#)
- [CALCulate:AVERage:MAXimum?](#)
- [CALCulate:AVERage:MINimum?](#)
- [CALCulate:AVERage:PTPeak?](#)
- [CALCulate:AVERage:SDEV?](#)
- [CALCulate:AVERage:CLear](#)
- [CALCulate:AVERage:COUNT?](#)
- [CALCulate:AVERage:MAXimum:TIME?](#)
- [CALCulate:AVERage:MINimum:TIME?](#)
- [CALCulate:COMPare:DATA](#)
- [CALCulate:COMPare:MASK](#)
- [CALCulate:COMPare:STATe](#)
- [CALCulate:COMPare:TYPE](#)
- [CALCulate:LIMit:LOWer](#)
- [CALCulate:LIMit:UPPer](#)
- [CALCulate:LIMit:LOWer:STATe](#)
- [CALCulate:LIMit:UPPer:STATe](#)
- [CALCulate:SCALe:SQUare](#)
- [CALCulate:SCALe:GAIN](#)
- [CALCulate:SCALe:OFFSet](#)
- [CALCulate:SCALe:CONStant](#)
- [CALCulate:SCALe:OFFSet:NULL](#)
- [CALCulate:SCALe:STATe](#)
- [CALCulate:SCALe:UNIT](#)

**CALCulate:AVERage:AVERage?**  
**CALCulate:AVERage:MAXimum?**  
**CALCulate:AVERage:MINimum?**  
**CALCulate:AVERage:PTPeak?**  
**CALCulate:AVERage:SDEV?**

**Syntax** CALCulate:AVERage:AVERage? [(@<ch\_list>)]  
 CALCulate:AVERage:MAXimum? [(@<ch\_list>)]  
 CALCulate:AVERage:MINimum? [(@<ch\_list>)]  
 CALCulate:AVERage:PTPeak? [(@<ch\_list>)]  
 CALCulate:AVERage:SDEV? [(@<ch\_list>)]

**Description** Query the statistical calculation results (average, maximum, minimum, peak to peak and standard deviation) of the readings of the specified channel.

Parameters	Name	Type	Range	Default
	<ch_list>	Channel List	One or more channels (the multiplexer channels, DIO channels or TOT channels), the rules are as follows: (@101): channel 01 on the module in Slot1; (@101:103): channel 01 through 03 on the module in Slot1; (@101:103,301,406:408): channel 01 through 03 on the module in Slot1, channel 01 on the module in Slot3 and channel 06 through 08 on the module in Slot4.	If the parameter is omitted, this command will be applied to the whole scan list.

- Explanation**
- <ch\_list> should be the multiplexer, digital or totalizer channels in the scan list. If the specified channel is not in the scan list, the query returns +0.000000000E+00 (but no error will be generated).
  - You can send command to read the statistical calculation results at any time, even during a scan.
  - An error will be generated if the DMM module is disabled (refer to the [INSTRument:DMM](#) command) or not installed.
  - The instrument clears the stored statistical data on all the channels under the following conditions:
    - when a new scan is started;
    - when the [CALCulate:AVERage:CLear](#) command is executed;
    - after a Factory Reset (send the [\\*RST](#) command);
    - after an Instrument Preset (send the [SYSTem:PRESet](#) command);

**Return Format** The query returns the specified numbers in scientific notation. Multiple return values are separated by commas. If no data is available for the specified channels, it returns +0.000000000E+00.

**Example** CALC:AVER:MAX? (@101,102)  
 The query returns +3.853443855E-03,+4.074533140E-03  
 You can replace MAX with AVER, MIN, PTP or SDEV to query the average, minimum, peak to peak or standard deviation value.

**Related commands** [CALCulate:AVERage:COUNt?](#)  
[CALCulate:AVERage:MAXimum:TIME?](#)  
[CALCulate:AVERage:MINimum:TIME?](#)

## CALCulate:AVERage:CLEar

**Syntax** CALCulate:AVERage:CLEar [(@<ch\_list>)]

**Description** Clear all the statistical data (average, maximum, minimum, peak to peak, standard deviation and count values) of the specified channels.

Parameters	Name	Type	Range	Default
	<ch_list>	Channel List	One or more channels (the multiplexer channels, DIO channels or TOT channels), the rules are as follows: (@101): channel 01 on the module in Slot1; (@101:103): channel 01 through 03 on the module in Slot1; (@101:103,301): channel 01 through 03 on the module in Slot1 and channel 01 on the module in Slot3.	If the parameter is omitted, this command will be applied to the whole scan list.

- Explanation**
- The channels specified in <ch\_list> should be the multiplexer, DIO or TOT channels in the scan list. If the specified channel is not in the scan list, this command is invalid (no error will be generated).
  - This command only clears the statistical data of the specified channels and no readings are cleared from the corresponding memory.
  - An error will be generated if the DMM module is disabled (refer to the [INSTrument:DMM](#) command) or not installed.
  - The instrument clears the stored statistical data on all the channels under the following conditions:
    - when a new scan is started;
    - when the [CALCulate:AVERage:CLEar](#) command is executed;
    - after a Factory Reset (send the [\\*RST](#) command);
    - after an Instrument Preset (send the [SYSTem:PRESet](#) command);

**Example** CALC:AVER:CLE (@101,102)

**Related commands**

- [CALCulate:AVERage:AVERage?](#)
- [CALCulate:AVERage:MAXimum?](#)
- [CALCulate:AVERage:MINimum?](#)
- [CALCulate:AVERage:SDEV?](#)
- [CALCulate:AVERage:COUNT?](#)
- [CALCulate:AVERage:PTPeak?](#)

## CALCulate:AVERage:COUNT?

**Syntax** CALCulate:AVERage:COUNT? [(@<ch\_list>)]

**Description** Query the number of readings taken on each of the specified channels.

**Parameters**

Name	Type	Range	Default
<ch_list>	Channel List	One or more channels (the multiplexer channels, DIO channels or TOT channels), the rules are as follows: (@101): channel 01 on the module in Slot1; (@101:103): channel 01 through 03 on the module in Slot1; (@101:103,301): channel 01 through 03 on the module in Slot1 and channel 01 on the module in Slot3.	If the parameter is omitted, this command will be applied to the whole scan list.

- Explanation**
- You can send command to read the statistical calculation results at any time, even during a scan.
  - An error will be generated if the DMM module is disabled (refer to the [INSTrument:DMM](#) command) or not installed.
  - The instrument clears the stored statistical data on all channels under the following conditions:
    - when a new scan is started;
    - when the [CALCulate:AVERage:CLear](#) command is executed;
    - after a Factory Reset (send the [\\*RST](#) command);
    - after an Instrument Preset (send the [SYSTem:PRESet](#) command);

**Return Format** The query returns the numbers of readings in scientific notation. Multiple return values are separated by commas. If no data is available for the specified channels, it returns +0.00000000E+00.

**Example** CALC:AVER:COUN? (@101,102)

The query returns +3.000000000E+01,+3.000000000E+01

**Related commands**

- [CALCulate:AVERage:AVERage?](#)
- [CALCulate:AVERage:MAXimum?](#)
- [CALCulate:AVERage:MINimum?](#)
- [CALCulate:AVERage:PTPeak?](#)
- [CALCulate:AVERage:SDEV?](#)

## CALCulate:AVERage:MAXimum:TIME?

## CALCulate:AVERage:MINimum:TIME?

**Syntax** CALCulate:AVERage:MAXimum:TIME? [(@<ch\_list>)]

CALCulate:AVERage:MINimum:TIME? [(@<ch\_list>)]

**Description** Query the time that the maximum or minimum reading was taken on the specified channels during the scan.

**Parameters**

Name	Type	Range	Default
<ch_list>	Channel List	One or more channels (the multiplexer channels, DIO channels or TOT channels), the rules are as follows: (@101): channel 01 on the module in Slot1; (@101:103): channel 01 through 03 on the module in Slot1; (@101:103,301): channel 01 through 03 on the module in Slot1 and channel 01 on the module in Slot3.	If the parameter is omitted, this command will be applied to the whole scan list.

- Explanation**
- You can send command to query the generation time of the maximum or minimum value at any time, even during a scan.
  - An error will be generated if the DMM module is disabled (refer to the [INSTrument:DMM](#) command) or not installed.
  - The instrument clears the stored statistical data on all channels under the following conditions:  
when a new scan is started,  
when the [CALCulate:AVERage:CLear](#) command is executed;  
after a Factory Reset (send the [\\*RST](#) command);  
after an Instrument Preset (send the [SYSTem:PRESet](#) command);
  - This command always returns the complete time and date. It will not be affected by the [FORMat:READing:TIME:TYPE](#) command.

**Return Format** The query returns the time in "yyyy,mm,dd,hh,mm,ss.sss" form. Multiple return values are separated by commas.

**Example** CALC:AVER:MAX:TIME? (@101,102)

The query returns 2012,01,07,17,29,32.703,2012,01,07,17,29,32.662

You can replace MAX with MIN to query the time that the minimum reading was taken on the specified channels during the scan.

**Related commands** [CALCulate:AVERage:MAXimum?](#)  
[CALCulate:AVERage:MINimum?](#)

## CALCulate:COMPare:DATA

**Syntax** CALCulate:COMPare:DATA <data>[,(@<ch\_list>)]

CALCulate:COMPare:DATA? [(@<ch\_list>)]

**Description** Set the alarm value of the input signal of the specified DIO channel.

### Parameters

Name	Type	Range	Default
<data>	Integer	8 bit: 0 to 255 16 bit: 0 to 65535 32 bit: 0 to 4294967295	None
<ch_list>	Channel List	One or more channels (the DIO channels), the rules are as follows: (@101): channel 01 on the module in Slot1; (@101:103): channel 01 through 03 on the module in Slot1; (@101:103,301): channel 01 through 03 on the module in Slot1 and channel 01 on the module in Slot3.	If the parameter is omitted, this command will be applied to the whole scan list.

- Explanation**
- This command is only valid for the DIO channels on the multifunction module. The specified DIO channels do not have to be part of the scan list.
  - The range of <data> depends on the bit setting of the channel. When the setting value of <data> exceeds the range, the instrument will convert the setting value to a binary number automatically, intercept the low bits of the binary number and ignore the high bits of the binary number. The number of bits intercepted equals the number of bits of the current channel. For example, when the number of bits of the channel is set to 8 bit, the range of <data> is from 0 to 255. If <data> is set to 256 (the binary number is 1 0000 0000), the actual setting value is 0 (intercept the 8 low bits; namely 0000 0000).
  - After setting the alarm value using this command, you can send the [CALCulate:COMPare:STATE](#) command enable the pattern comparison function of the DIO channel.
  - A Factory Reset (the [\\*RST](#) command) clears the alarm value and turns off the pattern comparison mode. An Instrument Preset (the [SYSTem:PRESet](#) command) and Card Reset (the [SYSTem:CPON](#) command) do not clear the data and does not turn off the pattern comparison mode.

**Return Format** The query returns a decimal integer. Multiple return values are separated by commas.

**Example** CALC:COMP:DATA 129,(@301)  
CALC:COMP:DATA? (@301)

The query returns +129.

**Related commands** [CALCulate:COMPare:MASK](#)  
[CALCulate:COMPare:TYPE](#)

## CALCulate:COMPare:MASK

**Syntax** CALCulate:COMPare:MASK <mask>[,(@<ch\_list>)]

CALCulate:COMPare:MASK? [(@<ch\_list>)]

**Description** Pattern comparisons can compare just the specified bits and ignore the other bits. This command sets the pattern of the active bits and the bits to be ignored (named the mask value) for the pattern comparison on the specified DIO channel.

Parameters	Name	Type	Range	Default
	<mask>	Integer	8 bit: 0 to 255 (0000 0000 to 1111 1111) 16 bit: 0 to 65535 (0000 0000 0000 0000 to 1111 1111 1111 1111) 32 bit: 0 to 4294967295 (0000 0000 0000 0000 0000 0000 0000 0000 to 1111 1111 1111 1111 1111 1111 1111 1111) Set the active bits to 1 and the bits to be ignored to 0.	None
	<ch_list>	Channel List	One or more channels (only the DIO channels), the rules are as follows: (@101): channel 01 on the module in Slot1; (@101:103): channel 01 through 03 on the module in Slot1; (@101:103,301): channel 01 through 03 on the module in Slot1 and channel 01 on the module in Slot3;	If the parameter is omitted, this command will be applied to the whole scan list.

- Explanation**
- This command is only valid for the DIO channels on the multifunction module. The specified DIO channels do not have to be part of the scan list.
  - The range of <mask> depends on the bit setting of the channel. When the setting value of <mask> exceeds the range, the instrument will convert the setting value to a binary number automatically, then intercept the low bits of the binary number and ignore the high bits of the binary number. The number of bits intercepted equals the number of bits of the current channel. For example, when the number of bits of the channel is set to 8 bit, the range of <mask> is from 0 to 255. If <mask> is set to 256 (the binary number is 1 0000 0000), the actual setting value is 0 (intercept the 8 low bits; namely 0000 0000).
  - This command is used in conjunction with the [CALCulate:COMPare:DATA](#) command to set the alarm value (refer to the "Example" in this section).
  - A Factory Reset (the [\\*RST](#) command) clears the mask and turns off the pattern comparison mode. An Instrument Preset (the [SYSTem:PRESet](#) command) and Card Reset (the [SYSTem:CPON](#) command) does not clear the mask and does not turn off the pattern comparison mode.

The query returns a decimal value. Multiple return values are separated by commas.

**Return Format**

**Example**

CALC:COMP:MASK 129,(@301) /\*Set the mask value to 1000 0001. The active bits are bit7 and bit0\*/

CALC:COMP:DATA 154,(@301) /\*Set the alarm value to 1001 1010\*/

CALC:COMP:TYPE EQU,(@301) /\*The instrument generates an alarm when the input pattern matches the alarm value\*/

CALC:COMP:STAT ON,(@301) /\*Enable the pattern comparison mode. The instrument generates an alarm when the bit7 and bit0 of the input pattern of the channel are 1 and 0 respectively\*/

**Related commands** [CALCulate:COMPare:STATE](#)  
[CALCulate:COMPare:TYPE](#)

## CALCulate:COMPare:STATe

**Syntax** CALCulate:COMPare:STATe <state>[,(@ch\_list)]

CALCulate:COMPare:STATe? [(@<ch\_list>)]

**Description** This command disables or enables the pattern comparison mode on the specified digital input channels. Once the pattern comparison mode was enabled, the instrument monitors the digital input value of the channel, compares the digital input value with the alarm value and generates an alarm when the digital input value is the same as or different from the pattern defined.

Parameters	Name	Type	Range	Default
	<state>	Bool	{OFF 0 ON 1}	None
	<ch_list>	Channel List	One or more channels (only for the DIO channels), the rules are as follows: (@101): channel 01 on the module in Slot1; (@101:103): channel 01 through 03 on the module in Slot1; (@101:103,301): channel 01 through 03 on the module in Slot1 and channel 01 on the module in Slot3.	If the parameter is omitted, this command will be applied to the whole scan list.

- Explanation**
- This command is only valid for the DIO channels of the multifunction module. The specified DIO channels do not have to be part of the scan list.
  - In pattern comparison, the bits of which the mask values (set by the [CALCulate:COMPare:MASK](#) command) are 0 will be ignored; only bits of which the mask values are 1 will be compared.
  - A Factory Reset (the [\\*RST](#) command) turns off the pattern comparison mode. An Instrument Preset (the [SYSTEM:PRESet](#) command) or Card Reset (the [SYSTEM:CPON](#) command) does not turn off the pattern comparison mode.

**Return Format** The query returns 0 or 1. Multiple return values are separated by commas.

**Example** CALC:COMP:STAT 1,(@301)  
CALC:COMP:STAT? (@301)

The query returns 1.

**Related commands** [CALCulate:COMPare:DATA](#)  
[CALCulate:COMPare:MASK](#)  
[CALCulate:COMPare:TYPE](#)



## CALCulate:COMPare:TYPE

**Syntax** CALCulate:COMPare:TYPE <mode>[,(@<ch\_list>)]

CALCulate:COMPare:TYPE? [(@<ch\_list>)]

**Description** This command sets the pattern comparison mode for the specified digital input channels. The instrument will generate an alarm when the digital input value is the same as or different from the pattern defined.

**Parameters**

Name	Type	Range	Default
<mode>	Discrete	{EQUAL NEQUAL}	None
<ch_list>	Channel List	One or more channels (only for the DIO channels), the rules are as follows: (@101): channel 01 on the module in Slot1; (@101:103): channel 01 through 03 on the module in Slot1; (@101:103,301): channel 01 through 03 on the module in Slot1 and channel 01 on the module in Slot3.	If the parameter is omitted, this command will be applied to the whole scan list.

- Explanation**
- This command is only valid for the DIO channels of MC3534 (multifunction module). The specified DIO channels do not have to be part of the scan list.
  - In pattern comparison, the bits of which the mask value (set using the [CALCulate:COMPare:MASK](#) command) are 0 will be ignored and only the bits of which the mask value is 1 will be compared. When EQUAL is selected, the instrument generates an alarm when the input pattern monitored is the same with the alarm value (set using the [CALCulate:COMPare:DATA](#) command). When NEQUAL is selected, the instrument generates an alarm when the input pattern monitored is different from the alarm value.
  - A Factory Reset (the [\\*RST](#) command) clears the pattern compare setting and turns off the pattern comparison mode. An Instrument Preset (the [SYSTEM:PRESet](#) command) or Card Reset (the [SYSTEM:CPON](#) command) does not clear the pattern compare setting and does not turn off the pattern comparison mode.

**Return Format** The query returns EQU or NEQ. Multiple return values are separated by commas.

**Example** CALC:COMP:TYPE EQU,(@301:304)  
 CALC:COMP:TYPE? (@301:304)

The query returns EQU,EQU,EQU,EQU.

**Related command** [CALCulate:COMPare:STATE](#)

## CALCulate:LIMit:LOWer

## CALCulate:LIMit:UPPer

**Syntax** CALCulate:LIMit:LOWer {<lo\_limit>|MAX|MIN}[,(@<ch\_list>)]  
 CALCulate:LIMit:LOWer? [(@<ch\_list>)]  
 CALCulate:LIMit:UPPer {<hi\_limit>|MAX|MIN}[,(@<ch\_list>)]  
 CALCulate:LIMit:UPPer? [(@<ch\_list>)]

**Description** Set the alarm lower and upper limits of the specified channels.

### Parameters

Name	Type	Range	Default
<lo_limit>	Numeric	<b>Multiplexer channel:</b> any numeric value between MIN and MAX MIN=-1.000000000E+15 MAX=+1.000000000E+15 <b>TOT Channel:</b> none	0
<hi_limit>	Numeric	<b>Multiplexer channel:</b> any numeric value between MIN and MAX MIN=-1.000000000E+15 MAX=+1.000000000E+15 <b>TOT Channel:</b> any integer between 0 and 4294967295 ( $2^{32}-1$ )	0 for the multiplexer channel and 1 for the TOT channel
<ch_list>	Channel List	One or more channels (only for the multiplexer channels and TOT channels), the rules are as follows: (@101): channel 01 on the module in Slot1; (@101:103): channel 01 through 03 on the module in Slot1; (@101:103,301): channel 01 through 03 on the module in Slot1 and channel 01 on the module in Slot3.	If the parameter is omitted, this command will be applied to the whole scan list.

- Explanation**
- For the multiplexer channels, an error is generated if the DMM module is not installed or is disabled. You can set a lower limit, an upper limit or both for the specified channel. The lower limit must always be lower than or equal to the upper limit.
  - For the TOT channels, the channels do not have to be part of the scan list and the DMM module is not required. You can only set the upper limit of the TOT channels.
  - Once you have defined the upper and lower limits using these commands, sending the [CALCulate:LIMit:LOWer:STATe](#) and [CALCulate:LIMit:UPPer:STATe](#) command can enable the corresponding alarm modes.
  - Changing the channel function and scaling parameters will turn off the alarm function and clear the alarm limits.
  - When a channel is removed from the scan list, its alarm limits will not be cleared. When it is re-added into the scan list (the channel function and scaling parameters are not changed), the alarm setting of this channel remains unchanged.
  - The query returns the alarm lower or upper limits of the specified channels. If <ch\_list> is omitted, the query returns the alarm lower or upper limits of all the multiplexer channels and TOT channels in the scan list. At this point, if the scan list is empty, an error will occur.
  - A Factory Reset (the [\\*RST](#) command) clears the alarm limits and turns off the alarm function. An Instrument Preset (the [SYSTem:PRESet](#) command) or Card Reset (the

[SYSTem:CPON](#) command) does not clear the alarm limits and does not turn off the alarm function.

**Return Format** The query returns the alarm limits in scientific notation. Multiple return values are separated by commas.

**Example** CALC:LIM:LOW 4.5,(@101)  
CALC:LIM:LOW? (@101)

The query returns +4.500000000E+00.

You can replace LOW with UPP to set and query the upper limits of the specified channels.

## CALCulate:LIMit:LOWer:STATe CALCulate:LIMit:UPPer:STATe

**Syntax** CALCulate:LIMit:LOWer:STATe <mode>,(@<ch\_list>)  
CALCulate:LIMit:LOWer:STATe? (@<ch\_list>)  
CALCulate:LIMit:UPPer:STATe <mode>,(@<ch\_list>)  
CALCulate:LIMit:UPPer:STATe? (@<ch\_list>)

**Description** Disable or enable the lower and upper alarm limits of the specified channels to set the alarm modes of the specified channels. The combinations of the upper limit and lower limit states correspond to the four alarm modes (NONE, LO, HI, HI + LO).

### Parameters

Name	Type	Range	Default
<mode>	Bool	{OFF 0 ON 1}	OFF
<ch_list>	Channel List	One or more channels (only for the multiplexer channels and TOT channels), the rules are as follows:  (@101): channel 01 on the module in Slot1; (@101:103): channel 01 through 03 on the module in Slot1; (@101:103,301): channel 01 through 03 on the module in Slot1 and channel 01 on the module in Slot3.	If the parameter is omitted, this command will be applied to the whole scan list.

**Explanation**

- For the multiplexer channels, an error is generated if the DMM module is not installed or is disabled. You can enable the alarm lower limit, alarm upper limit or both for the specified channel.
- For the TOT channels, the channels do not have to be part of the scan list and the DMM module is not required. You can only set the upper limit of the TOT channels.
- A Factory Reset (the [\\*RST](#) command) clears the alarm limits and turns off the alarm function. An Instrument Preset (the [SYSTem:PRESet](#) command) or Card Reset (the [SYSTem:CPON](#) command) does not clear the alarm limits and does not turn off the alarm function.

**Return Format** The query returns 0 or 1. Multiple return values are separated by commas.

**Example** CALC:LIM:LOW:STAT ON,(@101)  
CALC:LIM:LOW:STAT? (@101)

The query returns 1.

You can replace LOW with UPP to set or query the upper limits status.

**Related commands** [CALCulate:LIMit:LOWer](#)  
[CALCulate:LIMit:UPPer](#)

## CALCulate:SCALE:SQUare

## CALCulate:SCALE:GAIN

## CALCulate:SCALE:OFFSet

## CALCulate:SCALE:CONStant

**Syntax** CALCulate:SCALE:SQUare {<square>|MAX|MIN}[,(@<ch\_list>)]  
 CALCulate:SCALE:SQUare? [(@<ch\_list>)]  
 CALCulate:SCALE:GAIN {<gain>|MAX|MIN}[,(@<ch\_list>)]  
 CALCulate:SCALE:GAIN? [(@<ch\_list>)]  
 CALCulate:SCALE:OFFSet {<offset>|MAX|MIN}[,(@<ch\_list>)]  
 CALCulate:SCALE:OFFSet? [(@<ch\_list>)]  
 CALCulate:SCALE:CONStant {<constant>|MAX|MIN}[,(@<ch\_list>)]  
 CALCulate:SCALE:CONStant? [(@<ch\_list>)]

**Description** Set the scaling coefficients (**SQUare** (A), **GAIN** (B), **OFFSet** (x1) and **CONStant** (C)) of the specified channels.

### Parameters

Name	Type	Range of Values	Default Value
<square>	Numeric	Any numeric value between MIN and MAX MIN=-1.000000000E+15 MAX=+1.000000000E+15	0
<gain>			1
<offset>			0
<constant>			0
<ch_list>	Channel List	One or more channels (only for the multiplexer channels), the rules are as follows:  (@101): channel 01 on the module in Slot1; (@101:103): channel 01 through 03 on the module in Slot1; (@101:103,301): channel 01 through 03 on the module in Slot1 and channel 01 on the module in Slot3.	If the parameter is omitted, this command will be applied to the whole scan list.

- Explanation**
- The formula of the scaling function is:  

$$\text{Scaled Reading} = \text{SQUare} \times (\text{Reading} - \text{OFFSet})^2 + \text{GAIN} \times (\text{Reading} - \text{OFFSet}) + \text{CONStant}$$
  - An error is generated if the DMM module is not installed or is disabled (refer to the [INSTrument:DMM command](#)).
  - When the channel measurement function or the remperature sensor type is changed, the scaling function will be turned off and the scaling coefficients will be reset (A=0, B=1, C=0, x1=0).
  - Configuring the scaling coefficients will turn off the alarm function and clear the alarm parameters. Please configure the scaling parameters before configuring the alarm parameters.
  - A Factory Reset (the [\\*RST](#) command) turns off the scaling function and clears the scaling coefficients (A=0, B=1, C=0, x1=0). An Instrument Preset (the [SYSTem:PRESet](#) command) or Card Reset (the [SYSTem:CPON](#) command) does not turn off the scaling function and does not clear the scaling coefficients.

**Return Format** The query returns the coefficients in scientific notation. Multiple return values are separated by commas.

**Example** CALC:SCAL:SQU 10,(@101)  
 CALC:SCAL:SQU? (@101)  
 CALC:SCAL:GAIN 25,(@101)  
 CALC:SCAL:GAIN? (@101)  
 CALC:SCAL:OFFS 15,(@101)  
 CALC:SCAL:OFFS? (@101)  
 CALC:SCAL:CONS 5,(@101)  
 CALC:SCAL:CONS? (@101)

The query returns  
 +1.000000000E+01  
 +2.500000000E+01  
 +1.500000000E+01  
 +5.000000000E+00

**Related commands** [CALCulate:SCALE:OFFSet:NULL](#)  
[CALCulate:SCALE:STATe](#)  
[CALCulate:SCALE:UNIT](#)

## CALCulate:SCALE:OFFSet:NULL

**Syntax** CALCulate:SCALE:OFFSet:NULL [(@<ch\_list>)]

**Description** Set **OFFSet** (x1) to the measurement value.

Parameters	Name	Type	Range	Default
	<ch_list>	Channel List	One or more channels (only for the multiplexer channels), the rules are as follows: (@101): channel 01 on the module in Slot1; (@101:103): channel 01 through 03 on the module in Slot1; (@101:103,301): channel 01 through 03 on the module in Slot1 and channel 01 on the module in Slot3.	If the parameter is omitted, this command will be applied to the whole scan list.

**Example** CALC:SCAL:OFFS 2.5,(@101)  
 CALC:SCAL:OFFS? (@101)  
 CALC:SCAL:OFFS:NULL (@101)  
 CALC:SCAL:OFFS? (@101)

The query returns  
 +2.500000000E+00  
 -1.626940834E-03

**Related commands** [CALCulate:SCALE:SQUare](#)  
[CALCulate:SCALE:GAIN](#)  
[CALCulate:SCALE:OFFSet](#)  
[CALCulate:SCALE:CONStant](#)  
[CALCulate:SCALE:STATe](#)  
[CALCulate:SCALE:UNIT](#)

## CALCulate:SCALE:STATe

**Syntax** CALCulate:SCALE:STATe <state>[,(@<ch\_list>)]

CALCulate:SCALE:STATe? [(@<ch\_list>)]

**Description** Disable or enable the scaling function of the specified channels.

### Parameters

Name	Type	Range	Default
<state>	Bool	{OFF 0 ON 1}	OFF
<ch_list>	Channel List	One or more channels (only for the multiplexer channels), the rules are as follows: (@101): channel 01 on the module in Slot1; (@101:103): channel 01 through 03 on the module in Slot1; (@101:103,301): channel 01 through 03 on the module in Slot1 and channel 01 on the module in Slot3.	If the parameter is omitted, this command will be applied to the whole scan list.

### Explanation

- The formula of the scaling function is:  

$$\text{Scaled Reading} = \text{SQUare} \times (\text{Reading} - \text{OFFSet})^2 + \text{GAIN} \times (\text{Reading} - \text{OFFSet}) + \text{CONStant}$$
- The scaling function is only applicable to the multiplexer channels. To use this function, the DMM module must be installed and enabled.
- When the channel measurement function or measurement parameters is changed, the scaling function will be turned off and the scaling coefficients will be reset (A=0, B=1, C=0, x1=0).
- Configuring the scaling coefficients will turn off the alarm function and clear the alarm parameters. Please configure the scaling parameters before configuring the alarm parameters.
- A Factory Reset (the [\\*RST](#) command) turns off the scaling function and clears the scaling coefficients. An Instrument Preset (the [SYSTEM:PRESet](#) command) or Card Reset (the [SYSTEM:CPON](#) command) does not turn off the scaling function and does not clear the scaling coefficients.

### Return Format

The query returns 0 or 1. Multiple return values are separated by commas.

### Example

CALC:SCAL:STAT ON,(@101,102)

CALC:SCAL:STAT? (@101,102)

The query returns 1,1.

### Related commands

[CALCulate:SCALE:SQUare](#)

[CALCulate:SCALE:GAIN](#)

[CALCulate:SCALE:OFFSet](#)

[CALCulate:SCALE:CONStant](#)

[CALCulate:SCALE:OFFSet:NULL](#)

[CALCulate:SCALE:UNIT](#)

## CALCulate:SCALE:UNIT

**Syntax** CALCulate:SCALE:UNIT <quoted\_string>[,(@<ch\_list>)]

CALCulate:SCALE:UNIT? [(@<ch\_list>)]

**Description** Specify the unit of the scaled readings of the specified channels. It will affect the unit of the readings when storing the measurement data.

### Parameters

Name	Type	Range	Default
<quoted_string>	Discrete	{K #C #F ASCII String} Wherein, "#" represents the degree symbol (°); the ASCII string is enclosed in double quotation marks and cannot exceed three characters (it can contain English uppercase/lowercase letters (A-Z, a-z), numbers (0-9) or #. The first character cannot be a number).	The default unit of the current function <sup>[1]</sup> .
<ch_list>	Channel List	One or more channels (only for the multiplexer channels), the rules are as follows: (@101): channel 01 on the module in Slot1; (@101:103): channel 01 through 03 on the module in Slot1; (@101:103,301): channel 01 through 03 on the module in Slot1 and channel 01 on the module in Slot3.	If the parameter is omitted, this command will be applied to the whole scan list.

**Note**<sup>[1]</sup>: For the voltage measurement, the default unit is "V". For the current measurement, the default unit is "A". For the resistance measurement, the default unit is "Ω". For the frequency measurement, the default unit is "Hz". For the period measurement, the default unit is "s". For the temperature measurement, the default unit is "°C".

- Explanation**
- If you set the unit of the scaled readings to °C, °F, or K using this command, the unit of the temperature measurement will not be affected (refer to the [UNIT Command Subsystem](#)).
  - If the measurement function of the specified channel is Anysensor, the unit of the scaling is not allowed to set and an error will be generated when sending this command.
  - The commands in the [CONFigure Command Subsystem](#) and [MEASure Command Subsystem](#) will automatically revert the unit to the default units for the function.
  - The scaling unit is used when displaying and storing of the scaling readings and has no effect on the measurement units.
  - A Factory Reset (the [\\*RST](#) command) turns off the scaling function and clears the units of the scaling readings (the units are restored to the default units for the function). An Instrument Preset (the [SYSTem:PRESet](#) command) or Card Reset (the [SYSTem:CPON](#) command) does not turn off the scaling function and does not clear the units of the scaling readings.

**Return Format** The query returns "K", "#C", "#F" or ASCII strings enclosed in double quotation marks for the specified channels. Multiple return values are separated by commas.

**Example** CALC:SCAL:UNIT "PSI",(@101,102)  
CALC:SCAL:UNIT? (@101,102)

The query returns "PSI","PSI".

**Related commands**

- [CALCulate:SCALE:SQUare](#)
- [CALCulate:SCALE:GAIN](#)
- [CALCulate:SCALE:OFFSet](#)
- [CALCulate:SCALE:CONStant](#)
- [CALCulate:SCALE:OFFSet:NULL](#)
- [CALCulate:SCALE:STATe](#)



## CONFigure Command Subsystem

The CONFigure commands are used to configure the measurement function of the specified channel with the specified parameters, but do not start the scan. After finishing the configuration using the CONFigure commands, you can send the [INITiate](#) command to start the scan and then send the [READ?](#) command to read the measurement value.

- [CONFigure?](#)
- [CONFigure:ANYSensor](#)
- [CONFigure:COPY:CH:CH](#)
- [CONFigure:COPY:CH:SLOT](#)
- [CONFigure:COPY:SLOT:SLOT](#)
- [CONFigure:CURRent:AC](#)
- [CONFigure:CURRent\[:DC\]](#)
- [CONFigure:DIGital:BYTE](#)
- [CONFigure:DIGital:DWORd](#)
- [CONFigure:DIGital:WORD](#)
- [CONFigure:FREQuency](#)
- [CONFigure:PERiod](#)
- [CONFigure:FRESistance](#)
- [CONFigure:RESistance](#)
- [CONFigure:TEMPerature](#)
- [CONFigure:TOTalize](#)
- [CONFigure:VOLTage:AC](#)
- [CONFigure:VOLTage\[:DC\]](#)

## CONFigure?

**Syntax** CONFigure? [(@<ch\_list>)]

**Description** Query the current configuration of the specified channels.

**Parameters**

Name	Type	Range	Default
<ch_list>	Channel List	One or more channels (for the multiplexer channels, DIO channels or TOT channel), the rules are as follows: (@101): channel 01 on the module in Slot1; (@101:103): channel 01 through 03 on the module in Slot1; (@101:103,301): channel 01 through 03 on the module in Slot1 and channel 01 on the module in Slot3.	If the parameter is omitted, this command will be applied to the whole scan list.

**Explanation**

- The specified channels can only be multiplexer channels, DIO channels and TOT channels.
- If the current scan list is empty, the instrument will generate an error when you send the CONF? command.
- If the DMM module is not installed or is disabled, then no DMM-related configurations are allowed on the multiplexer channels. However, scan is allowed on the digital input and totalizer channels even when the DMM module is not installed or enabled.
- The CONFigure command does not place the instrument into the "wait-for-trigger" state. You can send the [INITiate](#) or [READ?](#) command with the CONFigure command to place the instrument into the "wait-for-trigger" state.
- The [\\*RST](#) command will clear the scan list and set all the measurement parameters to their factory settings (refer to [Appendix A: Factory](#)). The Instrument Preset (the [SYSTem:PRESet](#) command) will not clear the scan list but will clear the reading memory.

**Return Format**

The query returns the configurations (for the details, refer to the table below) of the specified channels in string enclosed in double quotation marks. Multiple return values are separated by commas.

<b>multiplexer channels</b>	<b>Function:</b> CURR CURR:AC VOLT VOLT:AC RES FRES FREQ PER TEMP <Temperature sensor type>,<Temperature Sensor Model> SENSOR <Anysensor type>	<b>Range</b> Return the specified value in scientific notation	<b>Resolution</b> Return the specified value in scientific notation
<b>DIO channels</b>	<b>Function:</b> DIG	<b>Status:</b> INP OUTP	<b>Width:</b> BYTE WORD DWORD
<b>TOT channels</b>	<b>Function:</b> TOT	<b>Mode:</b> READ RRES	--

**Example** CONF:VOLT:DC 20,DEF,(@101)

CONF:DIG:BYTE (@201)

**CONF? (@101,201)**

The query returns

"VOLT +2.000000E+01,+6.000000E-06","DIG INP BYTE".

**Related command** [CONFigure Command Subsystem](#)

## CONFigure:ANYSensor

**Syntax** CONFigure:ANYSensor [{<type>|DEF},](@<scan\_list>)

**Description** Configure the specified channel as the specified anysensor measurement function, but do not start the scan.

Parameters	Name	Type	Range	Default
	<type>	Discrete	{VOLT CURR FREQ}	VOLT or CURR <sup>[1]</sup>
	<scan_list>	Scan List	One or more channels (only for the multiplexer channels), the rules are as follows: (@101): channel 01 on the module in Slot1; (@101:103): channel 01 through 03 on the module in Slot1; (@101:103,301): channel 01 to channel 03 on the module in Slot1 and channel 01 on the module in Slot3.	None

**Note**<sup>[1]</sup>: When <type> is set to DEF or is omitted, for channels 21 to 24 of MC3324, the anysensor type is set to DCI; for other multiplexer channels, the anysensor type is set to DCV.

- Explanation**
- The values of <type> correspond to the following measurement functions respectively.  
VOLT: DCV; CURR: DCI; FREQ: FREQ.
  - <scan\_list> can only be the multiplexer channels.  
For channels 21 to 24 of MC3324, <type> can only be CURR;  
For all the channels of MC3164, <type> can not be CURR;  
For other multiplexer channels, <type> can not be CURR.
  - <scan\_list> overwrites the current scan list.

### Example 1

Configure channel 101 to the any sensor measurement function (the sensor type is 2WR). The READ? command makes the instrument enter the "Wait-for-trigger" state and execute a scan. During the scan, the instrument sends the readings to the reading memory and the output buffer of the instrument.

**CONF:ANYS RES,(@101)**

ROUT:SCAN (@101)

READ?

The query returns +8.329777419E+06.

### Example 2

Configure channel 104 and channel 106 to the any sensor measurement function (the sensor type is 2WR). The INITiate command makes the instrument enter the "Wait-for-trigger" state and execute a scan. During the scan, the instrument stores the readings to the reading memory. The FETCh? command sends the readings to the output

buffer of the instrument.

**CONF:ANYS RES,(@104,106)**

ROUT:SCAN (@104,106)

INIT

FETC?

The query returns +7.559019201E+06,+7.637811265E+06.

## CONFigure:COPIY:CH:CH

**Syntax** CONFigure:COPIY:CH:CH (@<channel>),(@<ch\_list>)

**Description** Copy the configuration of the source channel (specified by <channel>) to the destination channels (specified by <ch\_list>), namely channel copy.

Parameters	Name	Type	Range	Default
	<channel>	channel	One channel (for the multiplexer channel, DIO channel or TOT channel), the rules are as follows: (@101):channel 01 on the module in Slot1;	None
	<ch_list>	Channel List	One or more channels (for the multiplexer channels, DIO channels or TOT channel), the rules are as follows: (@101): channel 01 on the module in Slot1; (@101:103): channel 01 through 03 on the module in Slot1; (@101:103,301): channel 01 to channel 03 on the module in Slot1 and channel 01 on the module in Slot3;	None

- Explanation**
- The source channel specified by <channel> should be configured in the scan list. Otherwise, an error will be generated when sending this command.
  - <channel> can only be a single channel (the source channel) and <ch\_list> can be one or more channels (the destination channels). The channels specified by both of the parameters must be of the same type.
  - Channel copy are only allowed among channels of the same type.

Module	Channel Type
MC3120	All the channels are of the same type.
MC3132	All the channels are of the same type.
MC3164	All the channels are of the same type.
MC3324	Type 1: channel 01 to channel 20 Type 2: channel 21 to channel 24
MC3534	Type 1: channel 01 to channel 04 <sup>[1]</sup> Type 2: channel 05 to channel 06 Type 3: channel 07 to channel 08

**Note**<sup>[1]</sup>: The channel copy status of channel 01 to channel 04, is determined by the bits setting of the channels (refer to the [CONFigure:DIGital:BYTE](#), [CONFigure:DIGital:WORD](#) and [CONFigure:DIGital:DWORd commands](#)). When the bits is set to 8-bit, the channel copy can be performed among all the four channels. When the bits is set to 16-bit, the channel copy is only allowed between channel 01 and channel 03. When the bits is set to 32-bit, the channel copy is only allowed between channel 01 from different MC3534 modules.

- In the channel copy, the following settings of the source channel are copied to the destination channels.  
Measurement Configuration: include the measurement function, range, sensor type and etc.;
- Scaling Configuration: include the scaling switch status and scaling coefficients;

Alarm Configuration: include the alarm switch status, alarm channel number and alarm limits;

Advanced Configuration: include the integration time, AC filter and etc.

**Example** CONF:VOLT:DC (@101)  
CONF:COPY:CH:CH (@101),(@102:120)  
CONF? (@102,110)

The query returns

"VOLT +2.000000E+01,+6.000000E-06","VOLT +2.000000E+01,+6.000000E-06".

**Related command** [CONFigure Command Subsystem](#)

## CONFigure:COPY:CH:SLOT

**Syntax** CONFigure:COPY:CH:SLOT (@<channel>),<slot>

**Description** Copy the configuration of the source channel (specified by <channel>) to all the channels (of which the type is the same with that of the source channel) of the destination module (specified by <slot>), namely extended copy.

Parameters	Name	Type	Range	Default
	<channel>	Channel	One channel (for the multiplexer channel , DIO channel or TOT channel), the rules are as follows: (@101): channel 01 on the module in Slot1;	None
	<slot>	Discrete	100/200/300/400/500: the slot number of the destination module.	None

**Explanation**

- The source channel specified by <channel> should be configured in scan list. Otherwise, an error will be generated when sending this command.
- <channel> can only be a single channel (namely the source channel). <slot> defines the destination module which must be of the same type with the module of the source channel.
- In the extended copy, the following settings of the source channel are automatically copied to the destination module.
  - Measurement Configuration: include the measurement function, range, sensor type and etc.;
  - Scaling Configuration: include the scaling status and scaling coefficients;
  - Alarm Configuration: include the alarm status, alarm channel number and alarm limits;
  - Advanced Configuration: include the integration time, AC filter and etc.

**Example** It is assumed that both Slot1 and Slot2 are inserted with the MC3132 module.

CONF:VOLT:DC (@101)  
CONF:COPY:CH:SLOT (@101),200  
CONF? (@202,210)

The query returns

"VOLT +2.000000E+01,+6.000000E-06","VOLT +2.000000E+01,+6.000000E-06".

**Related command** [CONFigure Command Subsystem](#)

## CONFigure:COPIY:SLOT:SLOT

**Syntax** CONFigure:COPIY:SLOT:SLOT <slot1>,<slot2>

**Description** Copy the configuration of the source module (specified by <slot1>) to the destination module (specified by <slot2>), namely module copy.

Parameters	Name	Type	Range	Default
	<slot1>	Discrete	100/200/300/400/500: the slot number of the source module.	None
	<slot2>	Discrete	100/200/300/400/500: the slot number of the destination module.	None

- Explanation**
- <slot1> defines the source module and <slot2> defines the destination module. The type of the two modules must be the same.
  - In the module copy, the configurations of all the channels of the source module are automatically copied to the channels of the destination module.

**Example** It is assumed that both Slot1 and Slot2 are inserted with the MC3132 module.

```
CONF:VOLT:DC (@101:110)
CONF:COPIY:SLOT:SLOT 100,200
CONF? (@101,201)
```

The query returns  
"VOLT +2.000000E+01,+6.000000E-06","VOLT +2.000000E+01,+6.000000E-06".

**Related command** [CONFigure Command Subsystem](#)

## CONFigure:CURRent:AC

**Syntax** CONFigure:CURRent:AC [{<range>|AUTO|MIN|MAX|DEF}],{<resolution>|MIN|MAX|DEF},(@<scan\_list>)

**Description** Configure the specified channels to the ACI measurement function with the specified range and resolution, but do not initiate the scan.

Parameters	Name	Type	Range	Default
	<range>	Numeric	Any numeric value between 0 and 110*MAX. The final range is decided by the " <b>Principle of setting with greater value</b> " when <range> is between 0 and MAX; the final range is MAX when <range> is greater than MAX. The standard values of the range: {200μA 2mA 20mA 200mA 1A} Wherein, MIN=200μA, MAX=1A, DEF=AUTO.	AUTO
	<resolution>	Numeric	Can receive any numeric value or any of {MIN MAX DEF}, but the resolution is fixed at 6 <sup>1/2</sup> digits.	
	<scan_list>	Scan List	One or more channels (only for channel 21 to channel 24 of MC3324), the rules are as follows: (@121): channel 21 on the module in Slot1; (@121:123): channel 21 through 23 on the module in Slot1; (@121:123,321): channel 21 to 23 on the module in Slot1 and channel 21 on the module in Slot3.	None

- Explanation**
- This command is only applicable to channel 21 to channel 24 of MC3324. When

<scan\_list> is set to other channels, an error will be generated.

- The CONFIGure command does not place the instrument into the "wait-for-trigger" state. You can send the [INITiate](#) or [READ?](#) command with the CONFIGure command to place the instrument into the "wait-for-trigger" state.
- You can select autoranging to allow the instrument to automatically select a proper measurement range or you can select a fixed range to set the range manually.
- Autoranging rule: for signals under test that is between 10%\*Range and 110%\*Range, the instrument automatically selects Range as the current range.
- When <range> is set to DEF or AUTO, an error will be generated if <resolution> is set to a numeric value, because the instrument cannot calculate the integration time accurately (especially when the input signal is continuously changing) when the autoranging is combined with a numeric resolution. If your application requires autoranging, be sure to specify "DEF" for <resolution> or omit the parameter.
- If the input signal is greater than can be measured on the selected range, the instrument gives an overload indication: "OVERLOAD" from the front panel or "±9.9E+37" from the remote interface.
- The [\\*RST](#) command will clear the scan list and set all the measurement parameters to their factory settings. The Instrument Preset (the [SYSTem:PRESet](#) command) will not clear the scan list; however, this command will clear the data in the reading memory.
- <scan\_list> overwrites the current scan list.

### Example **Example 1**

Configure channel 121 to the ACI measurement function (use the default range and resolution). The READ? command makes the instrument enter the "Wait-for-trigger" state and execute a scan. During the scan, the instrument sends the readings to the reading memory and the output buffer of the instrument.

**CONF:CURR:AC DEF,DEF,(@121)**

ROUT:SCAN (@121)

READ?

The query returns +8.329777419E-02.

### Example **Example 2**

Configure channel 122 and channel 123 to the ACI measurement function (use 1A range and the default resolution). The INITiate command makes the instrument enter the "Wait-for-trigger" state and execute a scan. During the scan, the instrument stores the readings to the reading memory. The FETCh? command sends the readings to the output buffer of the instrument.

**CONF:CURR:AC 1,(@122,123)**

ROUT:SCAN (@122,123)

INIT

FETCh?

The query returns +4.395248241E-02,+1.419773083E-02.

**Related command** [CONFigure?](#)

## CONFigure:CURRent[:DC]

**Syntax** CONFigure:CURRent[:DC] [{<range>|AUTO|MIN|MAX|DEF}],{<resolution>|MIN|MAX|DEF}],(@<scan\_list>)

**Description** Configure the specified channels to the DCI measurement function with the specified range and resolution, but do not initiate the scan.

Parameters	Name	Type	Range	Default
	<range>	Numeric	Any numeric value between 0 and 110*MAX. The final range is decided by the " <b>Principle of setting with greater value</b> " when <range> is between 0 and MAX; the final range is MAX when <range> is greater than MAX. The standard values of the range: {200μA 2mA 20mA 200mA 1A} Wherein, MIN=200μA, MAX=1A, DEF=AUTO.	AUTO
	<resolution>	Numeric	Can receive any numeric value between 0.03ppm×<range> and 3ppm×<range>. The final resolution is decided by the " <b>Principle of setting with smaller value</b> ". The standard values of the resolution: refer to the " <b>Explanation</b> ".	0.3ppm×<range>
	<scan_list>	Scan List	One or more channels (only for channel 21 to channel 24 of MC3324), the rules are as follows: (@121): channel 21 on the module in Slot1; (@121:123): channel 21 through 23 on the module in Slot1; (@121:123,321): channel 21 through 23 on the module in Slot1 and channel 21 on the module in Slot3.	None

- Explanation**
- This command is only applicable to channel 21 to channel 24 of MC3324. When <scan\_list> is set to other channels, an error will be generated.
  - The CONFigure command does not place the instrument into the "wait-for-trigger" state. You can send the [INITiate](#) or [READ?](#) command with the CONFigure command to place the instrument into the "wait-for-trigger" state.
  - You can select autoranging to allow the instrument to automatically select a proper measurement range or you can select a fixed range to set the range manually.
  - Autoranging rule: for signals under test that is between 10%\*Range and 110%\*Range, the instrument automatically selects Range as the current range.
  - When <range> is set to DEF or AUTO, an error will be generated if <resolution> is set to a numeric value, because the instrument cannot calculate the integration time accurately (especially when the input signal is continuously changing) when the autoranging is combined with a numeric resolution. If your application requires autoranging, be sure to specify "DEF" for <resolution> or omit the parameter.
  - <resolution> is related to the current integration time and range (<range>). The relations are as shown in the table below.



Integration Time	Resolution
0.02PLC	3ppm× <range> (MAX)
0.2PLC	0.7ppm× <range>
1PLC	0.3ppm× <range> (DEF)
2PLC	0.2ppm× <range>
10PLC	0.1ppm× <range>
20PLC	0.06ppm× <range>
100PLC	0.035ppm× <range>
200PLC	0.03ppm× <range> (MIN)
Aperture Time Mode	0.03ppm× <range> (MIN)

- If the input signal is greater than can be measured on the selected range, the instrument gives an overload indication: "OVERLOAD" from the front panel or "±9.9E+37" from the remote interface.
- The [\\*RST](#) command will clear the scan list and set all the measurement parameters to their factory settings. The Instrument Preset (the [SYSTem:PRESet](#) command) will not clear the scan list; however, this command will clear the data in the reading memory.
- <scan\_list> overwrites the current scan list.

### Example Example 1

Configure channel 121 to the DCI measurement function (use the default range and resolution). The READ? command makes the instrument enter the "Wait-for-trigger" state and execute a scan. During the scan, the instrument sends the readings to the reading memory and the output buffer of the instrument.

**CONF:CURR:DC DEF,DEF,(@121)**

ROUT:SCAN (@121)

READ?

The query returns +8.329777419E-02.

### Example 2

Configure channel 122 and channel 123 to the DCI measurement function (use 1A range and the default resolution). The INITiate command makes the instrument enter the "Wait-for-trigger" state and execute a scan. During the scan, the instrument stores the readings to the reading memory. The FETCh? command sends the readings to the output buffer of the instrument.

**CONF:CURR:DC 1,(@122,123)**

ROUT:SCAN (@122,123)

INIT

FETCh?

The query returns +4.395248241E-02,+1.419773083E-02.

**Related command** [CONFigure?](#)

## CONFigure:DIgital:BYTE

## CONFigure:DIgital:DWORd

## CONFigure:DIgital:WORD

**Syntax** CONFigure:DIgital:BYTE (@<scan\_list>)  
 CONFigure:DIgital:DWORd (@<scan\_list>)  
 CONFigure:DIgital:WORD (@<scan\_list>)

**Description** Set the bits of the DIO channels when they are used as the digital input terminals. BYTE represents 8-bit, WORD represents 16-bit and DWORd represents 32-bit. This command does not initiate the scan.

### Parameters

Name	Type	Range	Default
<scan_list>	Scan List	One or more channels (only for channel 01 to channel 04 of MC3534), the rules are as follows: (@101): channel 01 on the module in Slot1; (@101:103): channel 01 through 03 on the module in Slot1; (@101:103,301): channel 01 to channel 03 on the module in Slot1 and channel 01 on the module in Slot3;	None

- Explanation**
- The digital input channels are usually numbered as "S01" to "S04"; wherein, S is the number of the slot of the multifunction module.
  - The CONFigure:DIgital:BYTE (@<scan\_list>) command is applicable to S01 to S04. The CONFigure:DIgital:WORD (@<scan\_list>) command is only applicable to S01 and S03. At this point, S01 (LSB) and S02 (MSB) as well as S03 (LSB) and S04 (MSB) are configured as two 16-bit digital input terminals. The CONFigure:DIgital: DWORd (@<scan\_list>) command is only applicable to S01. At this point, S01 (LSB), S02, S03 and S04 (MSB) are configured as a 32-bit digital input terminal.
  - The [\\*RST](#) command will clear the scan list and set all the measurement parameters to their factory settings. The Instrument Preset (the [SYSTem:PRESet](#) command) will not clear the scan list; however, this command will clear the data in the reading memory.
  - <scan\_list> overwrites the current scan list.

**Example** CONF:DIg:BYTE (@201:204)

## CONFigure:FREQuency

### CONFigure:PERiod

**Syntax** CONFigure:FREQuency  
 [{<range>|AUTO|MIN|MAX|DEF},{<resolution>|MIN|MAX|DEF}],(@<scan\_list>)  
 CONFigure:PERiod  
 [{<range>|AUTO|MIN|MAX|DEF},{<resolution>|MIN|MAX|DEF}],(@<scan\_list>)

**Description** Configure the specified channels to the frequency or period measurement function with the specified gate time, but do not initiate the scan.

#### Parameters

Name	Type	Range	Default
<range>	Numeric	Any numeric value or any of {AUTO MIN MAX DEF}. This parameter is unnecessary for the frequency and period measurements, the instrument only receives the parameter but does not respond to it.	AUTO
<resolution>	Numeric	Any numeric value between MIN and MAX. The final gate time is decided by the " <b>Principle of setting with greater value</b> ". The standard values of the gate time: {1ms 10ms 100ms 1s} Wherein, MIN=1ms, MAX=1s, DEF=100ms.	100ms
<scan_list>	Scan List	One or more channels (only for the multiplexer channels), the rules are as follows: (@101): channel 01 on the module in Slot1; (@101:103): channel 01 to channel 03 on the module in Slot1; (@101:103,301): channel 01 to channel 03 on the module in Slot1 and channel 01 on the module in Slot3;	None

- Explanation**
- If the input signal is greater than can be measured on the selected range, the instrument gives an overload indication: "OVERLOAD" from the front panel or "±9.9E+37" from the remote interface.
  - The **\*RST** command will clear the scan list and set all the measurement parameters to their factory settings. The Instrument Preset (the **SYSTem:PRESet** command) will not clear the scan list; however, this command will clear the data in the reading memory.
  - <scan\_list> overwrites the current scan list.

**Example** The examples of how to use the CONFigure:FREQuency command are provided below. You can replace CONF:FREQ in the examples with CONF:PER.

#### Example 1

Configure channel 101 to the FREQ measurement function (use the default range and resolution). The READ? command makes the instrument enter the "Wait-for-trigger" state and execute a scan. During the scan, the instrument sends the readings to the reading memory and the output buffer of the instrument.

```
CONF:FREQ DEF,DEF,(@101)
ROUT:SCAN (@101)
READ?
```

The query returns +1.329777419E+03.

#### Example 2

Configure channel 105 and channel 401 to the FREQ measurement function (use the default

range and resolution). The INITiate command makes the instrument enter the "Wait-for-trigger" state and execute a scan. During the scan, the instrument stores the readings to the reading memory. The FETCh? command sends the readings to the output buffer of the instrument.

**CONF:VOLT:AC (@105,401)**

ROUT:SCAN (@105,401)

INIT

FETC?

The query returns +1.395248241E+03,+1.019773083E+03.

**CONFigure:FRESistance**

**CONFigure:RESistance**

**Syntax** CONFigure:FRESistance  
 [{<range>|AUTO|MIN|MAX|DEF}[, {<resolution>|MIN|MAX|DEF}],](@<scan\_list>)

CONFigure:RESistance  
 [{<range>|AUTO|MIN|MAX|DEF}[, {<resolution>|MIN|MAX|DEF}],](@<scan\_list>)

**Description** Configure the specified channels to the 2-wire resistance or 4-wire resistance measurement function with the specified range and resolution, but do not initiate the scan.

**Parameters**

Name	Type	Range	Default
<range>	Numeric	Any numeric value between 0 and 110*MAX. The final range is decided by the " <b>Principle of setting with greater value</b> " when <range> is between 0 and MAX; the final range is MAX when <range> is greater than MAX. The standard values of the range: {200Ω 2kΩ 20kΩ 200kΩ 1MΩ 10MΩ 100MΩ} Wherein, MIN=200Ω, MAX=100MΩ, DEF=AUTO.	AUTO
<resolution>	Numeric	Any numeric value between 0.03ppm×<range> and 3ppm×<range>. The final resolution is decided by the " <b>Principle of setting with smaller value</b> ". The standard values of the resolution: refer to the " <b>Explanation</b> ".	0.3ppm×<range>
<scan_list>	Scan List	One or more channels (only for the multiplexer channels), the rules are as follows: (@101) :channel 01 on the module in Slot1; (@101:103): channel 01 through 03 on the module in Slot1; (@101:103,301): channel 01 through 03 on the module in Slot1 and channel 01 on the module in Slot3.	None

- Explanation**
- For MC3164, the 4-wire resistance measurement function is not supported.
  - For the 4-wire resistance measurement function, channel n is paired with channel n+16 (for MC3132, the range of n is from 1 to 16) or n+10 (for MC3324 and MC3120, the range of n is from 1 to 10) automatically. Channel n is used to connect the source terminal of the DMM and channel n+16 or channel n+10 is used to connect the sense terminal of the DMM. The paired channels cannot be configured.

- <range> is used to set the range. You can select autoranging to allow the instrument to automatically select a proper measurement range or you can select a fixed range to set the range manually.
- Autoranging rule: for signals under test that is between 10%\*Range and 110%\*Range, the instrument automatically selects Range as the current range.
- When <range> is set to DEF or AUTO, an error will be generated if <resolution> is set to a numeric value, because the instrument cannot calculate the integration time accurately (especially when the input signal is continuously changing) when the autoranging is combined with a numeric resolution. If your application requires autoranging, be sure to specify "DEF" for <resolution> or omit the parameter.
- <resolution> is related to the current integration time and range (<range>). The relations are as shown in the table below.

Integration Time	Resolution
0.02PLC	3ppm× <range> (MAX)
0.2PLC	0.7ppm× <range>
1PLC	0.3ppm× <range> (DEF)
2PLC	0.2ppm× <range>
10PLC	0.1ppm× <range>
20PLC	0.06ppm× <range>
100PLC	0.035ppm× <range>
200PLC	0.03ppm× <range> (MIN)
Aperture Time Mode	0.03ppm× <range> (MIN)

- If the input signal is greater than can be measured on the selected range, the instrument gives an overload indication: "OVERLOAD" from the front panel or "±9.9E+37" from the remote interface.
- The [\\*RST](#) command will clear the scan list and set all the measurement parameters to their factory settings. The Instrument Preset (the [SYSTem:PRESet](#) command) will not clear the scan list; however, this command will clear the data in the reading memory.
- <scan\_list> overwrites the current scan list.

**Example** The examples of how to use the CONF:RESistance command are provided below. You can replace CONF:RES in the examples with CONF:FRES.

#### Example 1

Configure channel 101 to the 2WR measurement function (use auto range and the default resolution). The READ? command makes the instrument enter the "Wait-for-trigger" state and execute a scan. During the scan, the instrument sends the readings to the reading memory and the output buffer of the instrument.

```
CONF:RES AUTO,DEF,(@101)
ROUT:SCAN (@101)
READ?
```

The query returns +1.335248419E+03.

#### Example 2

Configure channel 105 and channel 401 to the 2WR measurement function (use the default range and resolution). The INITiate command makes the instrument enter the "Wait-for-trigger" state and execute a scan. During the scan, the instrument stores the readings to the reading memory. The FETCh? command sends the readings to the output buffer of the instrument.

```
CONF:RES (@105,401)
ROUT:SCAN (@105,401)
```

INIT  
FETC?

The query returns +1.293248241E+03,+1.419773083E+03.

**Related commands** [CONFigure?](#)  
[INITiate](#)  
[READ?](#)

## CONFigure:TEMPerature

**Syntax** CONFigure:TEMPerature  
{<probe\_type>|DEF},{<type>|DEF}[,1[,{<resolution>|MIN|MAX|DEF}]],{@<scan\_list>}

**Description** Configure the specified channels to the temperature measurement function, but do not initiate the scan.

### Parameters

Name	Type	Range	Default	
<probe_type>	Discrete	{TCouple THERmistor RTD FRTD}	TC	
<type>	Discrete	TCouple	{B E J K N R S T}	J
		THERmistor	{2252 3000 5000 10000 30000}	5000
		RTD	{85 89 91 92}	85
		FRTD	{85 89 91 92}	85
<resolution>	Numeric	Can receive any numeric value. This parameter is unnecessary for the command. The instrument only receives the parameter but does not respond to it.		
<scan_list>	Scan List	One or more channels (only for the multiplexer channels), the rules are as follows: (@101): channel 01 on the module in Slot1; (@101:103): channel 01 through 03 on the module in Slot1; (@101:103,301): channel 01 through 03 on the module in Slot1 and channel 01 on the module in Slot3.	None	

- Explanation**
- For all the channels of MC3164, <probe\_type> can not be set to FRTD (4-wire RTD).
  - If <probe\_type> is specified as FRTD, channel n is paired with channel n+16 (for MC3132, the range of n is from 1 to 16) or n+10 (for MC3324 and MC3120, the range of n is from 1 to 10) automatically. Channel n is used to connect the source terminal of the DMM and channel n+16 or channel n+10 is used to connect the sense terminal of the DMM. The paired channels cannot be configured.
  - For the temperature measurements, the instrument selects the range internally and you do not need to set the range. Make sure that the command contains "1" (before <resolution>; it is used to replace <range>).
  - If the input signal is greater than can be measured on the selected range (manual ranging), the instrument gives an overload indication: "OVERLOAD" from the front panel or "±9.9E+37" from the remote interface.
  - When <probe\_type> is TCouple, if T/C Check is currently enabled and no thermocouple is connected, the measurement result is "OVERLOAD" and "±9.9E+37" will be returned in remote control. Note that at this point, the measurement value is not the value of the temperature under measurement.

- The [\\*RST](#) command will clear the scan list and set all the measurement parameters to their factory settings. The Instrument Preset (the [SYSTem:PRESet](#) command) will not clear the scan list; however, this command will clear the data in the reading memory.
- `<scan_list>` overwrites the current scan list.

**Example Example 1**

Configure channel 101 to the temperature measurement function (use B type thermocouple and the default resolution). The READ? command makes the instrument enter the "Wait-for-trigger" state and execute a scan. During the scan, the instrument sends the readings to the reading memory and the output buffer of the instrument.

**CONF:TEMP TC,B,1,DEF,(@101)**

ROUT:SCAN (@101)

READ?

The query returns +2.63260000E+01.

**Example 2**

Configure channel 105 and channel 401 to the temperature measurement function (use 5kΩ thermistor and the default resolution). The INITiate command makes the instrument enter the "Wait-for-trigger" state and execute a scan. During the scan, the instrument stores the readings to the reading memory. The FETCh? command sends the readings to the output buffer of the instrument.

**CONF:TEMP THER,5000,1,DEF,(@105,401)**

ROUT:SCAN (@105,401)

INIT

FETCh?

The query returns +2.70140000E+01,+2.71130000E+01.

**Related commands**

- [CONFigure?](#)
- [INITiate](#)
- [READ?](#)

**CONFigure:TOTalize**

**Syntax** CONFigure:TOTalize [<mode>],(@<scan\_list>)

**Description** Set the reading mode of the TOT channel of the specified channels. This command does not initiate the scan.

Parameters	Name	Type	Range	Default
	<mode>	Discrete	{READ RRESet}	READ
	<scan_list>	Scan List	One or more channels (only for the TOT channels), the rules are as follows: (@105): channel 05 on the module in Slot1; (@105:108): channel 05 through 08 on the module in Slot1; (@105:108,305): channel 05 through 08 on the module in Slot1 and channel 05 on the module in Slot3.	None

- Explanation**
- The totalizer channels are usually numbered as "S05" to "S08"; wherein, S is the number of the slot.
  - <mode> is used to set the reading mode of the TOT channels. When READ is selected, the instrument only reads the readings but does not reset the count. When

PRESet is selected, the instrument reads the readings and reset the count (namely, Read and Reset).

- The maximum count of each TOT channel is 42,9496,7295 ( $2^{32} - 1$ ). The count rolls over to 0 after reaching the maximum allowed value.
- Selecting the RRESet mode performs a synchronized read and reset operation on the specified totalizer channels. If you were to use discrete commands, such as the [READ?](#) and [\[SENSe:\]TOTAlize:CLEar:IMMediate](#) commands, you would likely lose counts occurring between the two commands.
- The [\\*RST](#) command will clear the scan list and set all the measurement parameters to their factory settings. The Instrument Preset (the [SYSTEM:PRESet](#) command) will not clear the scan list; however, this command will clear the data in the reading memory.
- `<scan_list>` overwrites the current scan list.

**Example** CONF:TOT READ,(@205:208)

**Related commands** [CONFigure?](#)  
[INITiate](#)

## CONFigure:VOLTage:AC

**Syntax** CONFigure:VOLTage:AC  
[<range>|AUTO|MIN|MAX|DEF],[<resolution>|MIN|MAX|DEF],(@<scan\_list>)

**Description** Configure the specified channels to the ACV measurement function with the specified range and resolution. This command does not initiate the scan.

### Parameters

Name	Type	Range	Default
<range>	Numeric	Any numeric value between 0 and 110*MAX. The final range is decided by the " <b>Principle of setting with greater value</b> " when <range> is between 0 and MAX; the final range is MAX when <range> is greater than MAX. The standard values of the range: {200mV 2V 20V 200V 300V}, wherein, MIN=200mV, MAX=300V, DEF=AUTO.	AUTO
<resolution>	Numeric	Can receive any numeric value or any of {MIN MAX DEF}, but the resolution is fixed at $6^{1/2}$ digits.	
<scan_list>	Scan List	One or more channels (only for the multiplexer channels), the rules are as follows: (@101): channel 01 on the module in Slot1; (@101:103): channel 01 through 03 on the module in Slot1; (@101:103,301): channel 01 through 03 on the module in Slot1 and channel 01 on the module in Slot3.	None

- Explanation**
- <range> is used to set the range. You can select autoranging to allow the instrument to automatically select a proper measurement range or you can select a fixed range to set the range manually.
  - Autoranging rule: for signals under test that is between 10%\*Range and 110%\*Range, the instrument automatically selects Range as the current range.
  - When <range> is set to DEF or AUTO, an error will be generated if <resolution> is set



to a numeric value, because the instrument cannot calculate the integration time accurately (especially when the input signal is continuously changing) when the autoranging is combined with a numeric resolution. If your application requires autoranging, be sure to specify "DEF" for <resolution> or omit the parameter.

- If the input signal is greater than can be measured on the selected range (manual ranging), the instrument gives an overload indication: "OVERLOAD" from the front panel or "±9.9E+37" from the remote interface.
- The **\*RST** command will clear the scan list and set all the measurement parameters to their factory settings. The Instrument Preset (the **SYSTem:PRESet** command) will not clear the scan list; however, this command will clear the data in the reading memory.
- The reading resolution of the ACV measurement function is fixed at 6<sup>1</sup>/<sub>2</sub> digits. Setting the resolution will not affect the measurement rate. You can control the measurement rate by modifying the channel delay (the **ROUTe:CHANnel:DELaY** command) or the AC filter type (the **[SENSe:]VOLTage:AC:BANDwidth** command).
- <scan\_list> overwrites the current scan list.

### Example Example 1

Configure channel 101 to the ACV measurement function (use 20V range and the default resolution). The READ? command makes the instrument enter the "Wait-for-trigger" state and execute a scan. During the scan, the instrument sends the readings to the reading memory and the output buffer of the instrument.

```
CONF:VOLT:AC 20,DEF,(@101)
ROUT:SCAN (@101)
READ?
```

The query returns +1.329777419E-01.

### Example 2

Configure channel 105 and channel 401 to the ACV measurement function (use 2V range and the default resolution). The INITiate command makes the instrument enter the "Wait-for-trigger" state and execute a scan. During the scan, the instrument stores the readings to the reading memory. The FETCh? command sends the readings to the output buffer of the instrument.

```
CONF:VOLT:AC 2,(@105,401)
ROUT:SCAN (@105,401)
INIT
FETC?
```

The query returns +1.395248241E-01,+1.019773083E-01.

**Related commands** [CONFigure?](#)  
[INITiate](#)  
[READ?](#)

## CONFigure:VOLTage[:DC]

**Syntax** CONFigure:VOLTage[:DC]  
[<range>|AUTO|MIN|MAX|DEF][,<resolution>|MIN|MAX|DEF][,](@<scan\_list>)

**Description** Configure the specified channels to the DCV measurement function with the specified range and resolution. This command does not initiate the scan.

### Parameters

Name	Type	Range	Default
<range>	Numeric	Any numeric value between 0 and 110*MAX. The final range is decided by the " <b>Principle of setting with greater value</b> " when <range> is between 0	AUTO

		and MAX; the final range is MAX when <range> is greater than MAX. The standard values of the range: {200mV 2V 20V 200V 300V}. Wherein, MIN=200mV, MAX=300V, DEF=AUTO.	
<resolution>	Numeric	Can receive any numeric value between 0.03ppm×<range> and 3ppm×<range>. The final resolution is decided by the " <b>Principle of setting with smaller value</b> ". The standard values of the resolution: refer to the " <b>Explanation</b> ".	0.3ppm×<range>
<scan_list>	Scan List	One or more channels (only for the multiplexer channels), the rules are as follows: (@101): channel 01 on the module in Slot1; (@101:103): channel 01 through 03 on the module in Slot1; (@101:103,301): channel 01 through 03 on the module in Slot1 and channel 01 on the module in Slot3.	None

- Explanation**
- <range> is used to set the range. You can select autoranging to allow the instrument to automatically select a proper measurement range or you can select a fixed range to set the range manually.
  - AAutoranging rule: for signals under test that is between 10%\*Range and 110%\*Range, the instrument automatically selects Range as the current range.
  - When <range> is set to DEF or AUTO, an error will be generated if <resolution> is set to a numeric value, because the instrument cannot calculate the integration time accurately (especially when the input signal is continuously changing) when the autoranging is combined with a numeric resolution. If your application requires autoranging, be sure to specify "DEF" for <resolution> or omit the parameter.
  - <resolution> is related to the current integration time and range (<range>). The relations are as shown in the table below.

Integration Time	Resolution
0.02PLC	3ppm× <range> (MAX)
0.2PLC	0.7ppm× <range>
1PLC	0.3ppm× <range> (DEF)
2PLC	0.2ppm× <range>
10PLC	0.1ppm× <range>
20PLC	0.06ppm× <range>
100PLC	0.035ppm× <range>
200PLC	0.03ppm× <range> (MIN)
Aperture Time Mode	0.03ppm× <range> (MIN)

- The [\\*RST](#) command will clear the scan list and set all the measurement parameters to their factory settings. The Instrument Preset (the [SYSTEM:PRESet](#) command) will not clear the scan list; however, this command will clear the data in the reading memory.
- If the input signal is greater than can be measured on the selected range (manual ranging), the instrument gives an overload indication: "OVERLOAD" from the front panel or "±9.9E+37" from the remote interface.
- <scan\_list> overwrites the current scan list.

**Example Example 1**

Configure channel 101 to the DCV measurement function (use 20V range and the default resolution). The READ? command makes the instrument enter the "Wait-for-trigger" state and execute a scan. During the scan, the instrument sends the readings to the reading memory and the output buffer of the instrument.

**CONF:VOLT:DC 20,DEF,(@101)**

ROUT:SCAN (@101)

READ?

The query returns +1.078752633E-01.

### Example 2

Configure channel 105 and channel 401 to the DCV measurement function (use 2V range and the default resolution). The INITiate command makes the instrument enter the "Wait-for-trigger" state and execute a scan. During the scan, the instrument stores the readings to the reading memory. The FETCh? command sends the readings to the output buffer of the instrument.

**CONF:VOLT:DC 2,(@105,401)**

ROUT:SCAN (@105,401)

INIT

FETC?

The query returns +4.048660076E-02,+2.488644243E-03.

**Related commands** [CONFigure?](#)  
[INITiate](#)  
[READ?](#)

# DATA Command Subsystem

- [DATA:LAST?](#)
- [DATA:POINts?](#)
- [DATA:POINts:EVENT:THReshold](#)
- [DATA:REMOve?](#)

## DATA:LAST?

**Syntax** DATA:LAST? [<num\_rdgs>,@<channel>]

**Description** Query the most recent reading or readings taken on the specified channel during the scan.

**Parameters**

Name	Type	Range	Default
<num_rdgs>	Integer	1 to the number of readings stored in the internal memory for the specified channel.	1 <sup>[1]</sup>
<channel>	Channel	One channel (for the multiplexer channel, DIO channel and TOT channel), the rules are as follows:  (@101): channel 01 on the module in Slot1;	None

**Note**<sup>[1]</sup>: When you omit this parameter, this query returns the most recent reading during the scan.

**Explanation**

- Readings can be acquired during a scan or after scan by using this command. If there were no scan readings in the internal memory, the instrument generates an error after sending this command.
- The query returns the readings in time order, starting with the earliest reading.
- When <num\_rdgs> is greater than the number of readings stored in the internal memory of the specified channel, the instrument generates an error.
- <channel> has to be part of the scan list. Otherwise, an error will be generated.
- The return value may consist of the readings, measurement units, time stamp, channel number and alarm information, depending on the settings of the [FORMat Command Subsystem](#) commands. The time stamp can be either relative time (record time of the reading relative to the beginning of the scan, the unit is s) or absolute time (in YYYY,MM,DD,hh,mm,ss.sss form. It is determined by the current system time set by the [SYSTem:DATE](#) and [SYSTem:TIME](#) commands). You can use the [FORMat:READIng:TIME:TYPE](#) command to set the time type.

**Return Format**

The query returns one or more readings on the specified channel in the following format. Multiple return values are separated by commas.

Format Explanation:

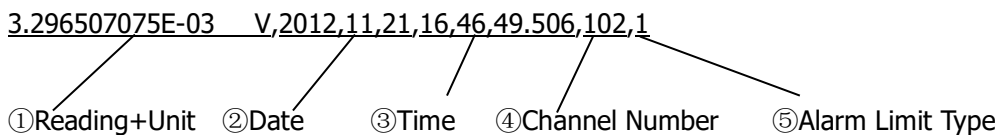

Wherein, the definition of ⑤Alarm Limit Type: 0=None; 1=LO; 2=HI.

**Example**

DATA:LAST? (@101)

The query returns 2.332050726E-03 V,2012,11,21,16,50,03.731,101,1.

**Related command**

[DATA Command Subsystem](#)

## DATA:POINts?

**Syntax** DATA:POINts?

**Description** Query the total number of readings currently stored in the reading memory.

- Explanation**
- You can send this command to query the total number of readings during or after a scan.
  - During the scan, you can store at most 10,000 readings and all the readings are automatically time stamped. If the memory overflows, bit12 in the questionable status register will be set to 1 (refer to the [STATus:QUEStionable:CONDition?](#) command) and the new readings will overwrite the oldest readings stored.
  - Bit12 in the questionable status register will be cleared when the memory is cleared. Note that bit12 in the questionable status register will not be cleared if the memory is emptied with the [DATA:REMove?](#) or [R?](#) command.
  - The reading operation does not clear the readings in the memory. The instrument clears all the readings in the memory when a new scan is initiated, after a Factory Reset (the [\\*RST](#) command) or after an Instrument Preset (the [SYSTem:PRESet](#) command).

**Return Format** The query returns an integer from 0 to 10,000.

**Example** DATA:POIN?  
The query returns +20579.

**Related command** [DATA Command Subsystem](#)

## DATA:POINts:EVENT:THReshold

**Syntax** DATA:POINts:EVENT:THReshold <num\_rdg>  
DATA:POINts:EVENT:THReshold?

**Description** Bit9 in the event register of the standard operation register set is set to 1 when the number of stored readings in the reading memory is greater the specified value (the memory threshold). These commands are used to set and query the memory threshold.

Parameters	Name	Type	Range	Default
	<num_rdg>	Integer	1 to 10,000	None

- Explanation**
- You can use the [STATus:OPERation:ENABLE](#) command to set bit9 in the event register of the standard operation register set to 1.
  - Once bit9 in the event register of the standard operation register set to 1, it will remain set until cleared by the [STATus:OPERation\[:EVENT\]?](#) command or [\\*CLS](#) command.
  - The instrument resets the memory threshold to 1 after a Factory Reset (the [\\*RST](#) command) or when the mainframe power is cycled. The [SYSTem:PRESet](#), [\\*CLS](#), or [STATus:PRESet](#) command does not affect the memory threshold.

**Return Format** The query returns a signed integer.

**Example** DATA:POIN:EVENT:THR 100  
DATA:POIN:EVENT:THR?  
The query returns +100.

**Related command** [DATA Command Subsystem](#)

## DATA:REMove?

**Syntax** DATA:REMove? <num\_rdgs>

**Description** Read and clear the specified number (<num\_rdgs>) of readings (the oldest readings) from the non-volatile memory (refer to [Appendix C: Non-volatile Memory](#)).

**Parameters**

Name	Type	Range	Default
<num_rdgs>	Integer	1 to 10,0000	None

**Explanation**

- If the memory overflows during a scan, the new readings will overwrite the oldest readings stored. You can use this command to read and clear the oldest readings to avoid losing readings.
- You can send this command to read and clear the specified number of readings during or after a scan.
- <num\_rdgs> cannot be greater than the number of readings currently in the memory;; otherwise, an error will be generated. You can send the [DATA:POINTS?](#) command to query the number of readings currently in the memory.
- The return value may consist of the readings, measurement units, time stamp, channel number and alarm information, depending on the settings of the [FORMat Command Subsystem](#) commands. The time stamp can be either relative time (record time of the reading relative to the beginning of the scan, the unit is s) or absolute time (in YYYY,MM,DD,hh,mm,ss.sss form. It is determined by the current system time set by the [SYSTem:DATE](#) and [SYSTem:TIME](#) commands). You can use the [FORMat:READInG:TIME:TYPE](#) command to set the time type.
- The instrument clears all readings from the memory when a new scan is initiated, after a Factory Reset (the [\\*RST](#) command) or after an Instrument Preset (the [SYSTem:PRESet](#) command).

**Return Format** The query returns the specified number of readings (the format is set by the [FORMat Command Subsystem](#) commands). Multiple return values are separated by commas.

**Example** DATA:REM? 2

The query returns +1.27150000E+01,+1.32130000E+01.

## DIAGnostic Command Subsystem

- [DIAGnostic:DMM:CYCLes?](#)
- [DIAGnostic:DMM:CYCLes:CLEar](#)
- [DIAGnostic:PEEK:SLOT:DATA](#)
- [DIAGnostic:POKE:SLOT:DATA](#)
- [DIAGnostic:RELAy:CYCLes?](#)
- [DIAGnostic:RELAy:CYCLes:CLEar](#)

### DIAGnostic:DMM:CYCLes?

**Syntax** DIAGnostic:DMM:CYCLes?

**Description** Query the cycle count of the 6 relays on the DMM module. The query returns six numbers indicating the cycle count on relays 1, 2, 3, 4, 5 and 6 (which correspond to relays K1, K2, K3, K4, K5 and K6 respectively).

**Explanation**

- These relays open or close when the function or range of the DMM module is changed.
- The instrument generates an error if the DMM module is not installed when sending this command.

**Return Format** The query returns 6 numbers, indicating the cycle counts of the 6 relays respectively.

**Example** DIAG:DMM:CYCL?  
The query returns +0,+0,+0,+0,+37,+0.

### DIAGnostic:DMM:CYCLes:CLEar

**Syntax** DIAGnostic:DMM:CYCLes:CLEar {1|2|3|4|5|6}

**Description** Reset the cycle counts of the 6 relays on the DMM module.

Parameters	Name	Type	Range	Default
	{1 2 3 4 5 6}	Discrete	1 2 3 4 5 6	None

**Example** DIAG:DMM:CYCL:CLE 1

**Related command** [DIAGnostic:DMM:CYCLes?](#)

## DIAGnostic:PEEK:SLOT:DATA?

## DIAGnostic:POKE:SLOT:DATA

**Syntax** DIAGnostic:PEEK:SLOT:DATA? {100|200|300|400|500}

DIAGnostic:POKE:SLOT:DATA {100|200|300|400|500},<quoted\_string>

**Description** The POKE command is used to define the labels for the 5 module slots. The PEEK command is used to query the label of the specified slot.

Parameters	Name	Type	Range	Default
	{100 200 300 400 500}	Discrete	100 200 300 400 500	None
	<quoted_string>	ASCII String	ASCII string enclosed in double quotation marks of up to 10 characters.	None

**Description**

- <quoted\_string> cannot exceeds 10 characters. When the string contains more than 10 characters, the additional characters will be ingorned but no error will be generated.
- The label specified by <quoted\_string> is stored in the non-volatile memory (refer to [Appendix C: Non-volatile Memory](#)) and a Factory Reset (the [\\*RST](#) command) will not clear the label.

**Return Format** The query returns the quoted label string. For example, "DMM".

**Example** DIAG:POKE:SLOT:DATA 100,"MUX32-1"  
 DIAG:PEEK:SLOT:DATA? 100  
 The query returns "MUX32-1".

## DIAGnostic:RELAy:CYCLes?

**Syntax** DIAGnostic:RELAy:CYCLes? (@<ch\_list>)

**Description** Query the cycle count of the relays of the specified channels.

Parameters	Name	Type	Range	Default
	<ch_list>	Channel List	One or more channels (for the multiplexer, actuator and matrix switch channels), the rules are as follows: (@101): channel 01 on the module in Slot1; (@101:103): channel 01 through 03 on the module in Slot1; (@101:103,301): channel 01 through 03 on the module in Slot1 and channel 01 on the module in Slot3.	None

**Explanation**

- The command queries the cycle counts of the channel relays and group relays of each module (except the DMM module and Multifunction module). For the location of each module relay, please refer to [Appendix E: Module Schematic Diagram](#).
- To read the cycle count of the relays on the DMM module, use the [DIAGnostic:DMM:CYCLes?](#) command.

**Return Format** The query returns the cycle count (from 0 to 4,294,967,295 (32-bit value)) of the specified relay in integer. Multiple return values are separated by commas.

**Example** DIAG:REL:CYCL? (@101:108)  
 The query returns +642,+632,+531,+30,+132,+33,+30,+8.



**Related command** [DIAGnostic:RElay:CYCLes:CLear](#)

## DIAGnostic:RElay:CYCLes:CLear

**Syntax** DIAGnostic:RElay:CYCLes:CLear (@<ch\_list>)

**Description** Reset the cycle count of the specified channel relays.

Parameters	Name	Type	Range	Default
	<ch_list>	Channel List	One or more channels (for the multiplexer, actuator and matrix switch channels), the rules are as follows:  (@101): channel 01 on the module in Slot1; (@101:103): channel 01 through 03 on the module in Slot1; (@101:103,301): channel 01 through 03 on the module in Slot1 and channel 01 on the module in Slot3.	None

- Explanation**
- The command reset the cycle counts of the channel relays and group relays of each module (except the DMM module and Multifunction module). For the location of each module relay, please refer to [Appendix E: Module Schematic Diagram](#).
  - To reset the cycle count of the relays on the DMM module, use the [DIAGnostic:DMM:CYCLes:CLear](#) command.

**Example** DIAG:REL:CYCL:CLE (@101:108)  
DIAG:REL:CYCL? (@101:108)

The query returns +0,+0,+0,+0,+0,+0,+0,+0.

**Related command** [DIAGnostic:RElay:CYCLes?](#)

## DISPlay Command Subsystem

- [DISPlay](#)
- [DISPlay:TEXT](#)
- [DISPlay:TEXT:CLEAr](#)

### DISPlay

**Syntax** DISPlay <state>



DISPlay?

**Description** Turn on or off the front-panel display.

**Parameters**

Name	Type	Range	Default
<state>	Bool	{OFF 0 ON 1}	ON

**Explanation**

- When turned off, the entire front-panel display goes dark and all the status icons except Error are disabled.
- All the keys at the front panel except  are disabled when the display is off. Press  to switch to the local mode and turn on the display.
- You can only turn off the front-panel display from the remote interface.
- Sending a text message to the display (see [DISPlay:TEXT](#) command) overrides the display state; this means that you can display a message even if the display is turned off.
- The front-panel display is automatically turned on when the power is cycled, after a Factory Reset (the [\\*RST](#) command), after an Instrument Preset (the [SYSTEM:PRESet](#) command) or when  is pressed.

**Return Format** The query returns 0 (OFF) or 1 (ON).

**Example** DISP OFF  
DISP?

The query returns 0.

**Related command** [DISPlay Command Subsystem](#)

## DISPlay:TEXT

**Syntax** DISPlay:TEXT <quoted\_string>

DISPlay:TEXT?

**Description** Send the text message to be displayed and the message will be displayed on the front-panel display.

Parameters	Name	Type	Range	Default
	<quoted_string>	ASCII String	A string of up to 19 characters enclosed in double quotation marks or single quotation mark. It can contain English letters (a-z, A-Z), numbers (0-9) and special characters (such as @, % and *). # is used to display a degree symbol (°).	None

- Explanation**
- <quoted\_string> can contain up to 19 characters. Any additional characters are truncated (no error is generated).
  - Sending a text message to the display overrides the display state, this means that you can display a message even if the display is turned off.
  - The front-panel display is automatically cleared under the following conditions:
    - When power is cycled;
    - After a Factory Reset (the [\\*RST](#) command);
    - After an Instrument Preset (the [SYSTem:PRESet](#) command);
    - Sending the [DISPlay:TEXT:CLEar](#) command;

**Return Format** The query returns an ASCII string enclosed in double quotation marks. If no message is currently displayed, the query returns "".

**Example** DISP:TEXT "Scanning"

DISP:TEXT?

Typical Response: "Scanning"

DISP:TEXT 'Scanning'

DISP:TEXT?

The query returns "Scanning".

**Related command** [DISPlay Command Subsystem](#)

## DISPlay:TEXT:CLEar

**Syntax** DISPlay:TEXT:CLEar

**Description** This command clears the text message displayed on the front-panel display of the instrument.

- Explanation**
- The display status has no effect on this command. No matter whether the display is enabled or not, you can send this command to clear the text message currently displayed. Clearing the text message does not override the display state, if the display was disabled prior to clearing the text message, the display will remain disabled.
  - The front-panel display is automatically cleared when the power is cycled, after a Factory Reset (the [\\*RST](#) command), or after an Instrument Preset (the [SYSTem:PRESet](#) command).

**Example** DISP:TEXT:CLE

**Related command** [DISPlay Command Subsystem](#)

## FETCh?

**Syntax** FETCh?

**Description** Send the readings stored in the non-volatile memory (refer to [Appendix C: Non-volatile Memory](#)) to the output buffer of the instrument without clearing the readings stored in memory.

**Explanation**

- The FETCh? command will wait until the scan is complete to terminate.
- Each time you start a new scan, the instrument clears all the readings (including the alarm data) stored in the reading memory from the previous measurement. Therefore, the readings acquired using the FETCh? command are always from the most recent scan.
- The format of the return value of this command is affected by the settings of the [FORMat Command Subsystem](#) commands. Depending on the different settings, each reading may or may not contain the measurement units, time stamp, channel number and alarm status information.

**Return Format** The query return the readings (the format depends on the settings of the [FORMat Command Subsystem](#) commands) in the memory in scientific notation. Multiple return values are separated by commas.

**Example**

```
CONF:VOLT:DC 20,DEF,(@401:403)
ROUT:SCAN (@401:403)
TRIG:SOUR BUS
INIT
*TRG
FETC?
```

The query returns +3.719443659E-03,+2.886192029E-03,+2.832327041E-03.

**Related commands** [INITiate](#)  
[ROUTe:SCAN](#)

## FORMat Command Subsystem

During a scan, the instrument automatically adds a time stamp to all the readings and stores them in the memory. Each reading is also stored with the corresponding information, including the measurement units, time stamp, channel number and alarm status information. You can set return value format of the scan result query commands (the [R?](#), [READ?](#), [FETCh?](#) commands and etc.) using the [FORMat Command Subsystem](#) commands (enabling or disabling the measurement units, time stamp, channel number, and alarm status information).

- [FORMat:READing:ALARm](#)
- [FORMat:READing:CHANnel](#)
- [FORMat:READing:TIME](#)
- [FORMat:READing:TIME:TYPE](#)
- [FORMat:READing:UNIT](#)

### Explanation:

The return readings only contain the measurement value by default, for example, +3.296507075E-03. If the unit, time stamp, channel number and alarm information are all enabled, the readings are returned in the following two forms based on different time stamp types.

#### 1 RELative

+3.296507075E-03 V,000000007.282,102,1

①Readings+Unit    ②Relative Time    ③Channel Number    ④Alarm Limit Type

#### 2 ABSolute

+3.296507075E-03 V,2012,11,21,16,46,49.506,102,1

①Readings+Unit    ②Absolute Time    ③Channel Number    ④Alarm Limit Type

Wherein, the definition of ④ Alarm Limit Type is: 0=None; 1=LO; 2=HI.

## FORMat:READIng:ALARm

**Syntax** FORMat:READIng:ALARm <state>

FORMat:READIng:ALARm?

**Description** Disable or enable the alarm information in the return readings of the scan result query commands (such as the [READ?](#) command, the [R?](#) command and the [FETCh?](#) command).

Parameters	Name	Type	Range	Default
	<state>	Bool	OFF 0 ON 1	OFF

- Explanation**
- The setting applies to all the readings acquired in the scan. You cannot set the reading format on a per-channel basis.
  - This command operates in conjunction with the other [FORMat Command Subsystem](#) commands (they are not mutually exclusive).
  - This setting is stored in the volatile memory (refer to [Appendix D: Volatile Memory](#)) and will be disabled (OFF) when the power is turned off or after a Factory Reset (the [\\*RST](#) command).

**Return Format** The query returns 0 (OFF) or 1 (ON).

**Example** FORM:READ:ALAR ON  
FORM:READ:ALAR?  
The query returns 1.

**Related commands** [R?](#)  
[READ?](#)  
[FETCh?](#)

## FORMat:READIng:CHANnel

**Syntax** FORMat:READIng:CHANnel <mode>

FORMat:READIng:CHANnel?

**Description** Disable or enable the channel number in the return readings of the scan result query commands (such as the [READ?](#) command, the [R?](#) command and the [FETCh?](#) command).

Parameters	Name	Type	Range	Default
	<mode>	Bool	OFF 0 ON 1	OFF

- Explanation**
- The setting applies to all the readings acquired in the scan. You cannot set the reading format on a per-channel basis.
  - This command operates in conjunction with the other [FORMat Command Subsystem](#) commands (they are not mutually exclusive).
  - This setting is stored in the volatile memory (refer to [Appendix D: Volatile Memory](#)) and will be disabled (OFF) when the power is turned off or after a Factory Reset (the [\\*RST](#) command).

**Return Format** The query returns 0(OFF) or 1(ON).

**Example** FORM:READ:CHAN ON  
FORM:READ:CHAN?  
The query returns 1.

## FORMat:READIng:TIME

**Syntax** FORMat:READIng:TIME <mode>

FORMat:READIng:TIME?

**Description** Disable or enable the time stamp in the return readings of the scan result query commands (such as the [READ?](#) command, the [R?](#) command and the [FETCh?](#) command).

Parameters	Name	Type	Range	Default
	<mode>	Bool	{OFF 0 ON 1}	OFF

- Explanation**
- The setting applies to all the readings acquired in the scan. You cannot set the reading format on a per-channel basis.
  - This command operates in conjunction with the other [FORMat Command Subsystem](#) commands (they are not mutually exclusive).
  - If enabled, the time stamp information is shown either in absolute time (time of day with date) or relative time (time in seconds relative to the start of the scan) as set by the [FORMat:READIng:TIME:TYPE](#) command.
  - This setting is stored in the volatile memory (refer to [Appendix D: Volatile Memory](#)) and will be disabled (OFF) when the power is turned off or after a Factory Reset (the [\\*RST](#) command).

**Return Format** The query returns 0 (OFF) or 1 (ON).

**Example** FORM:READ:TIME ON  
FORM:READ:TIME?  
The query returns 1.

## FORMat:READIng:TIME:TYPE

**Syntax** FORMat:READIng:TIME:TYPE <format>

FORMat:READIng:TIME:TYPE?

**Description** Set the time format for the time stamps returned when [FORMat:READIng:TIME](#) is ON.

Parameters	Name	Type	Range	Default
	<format>	Discrete	{ABSolute RELative}	RELative

- Explanation**
- There are two types of time stamps: ABSolute — absolute time, consists of the date and time; RELative — relative time, the duration since the start of the scan and the unit is s.
  - The setting applies to all the readings acquired in the scan. You cannot set the reading format on a per-channel basis.
  - This command operates in conjunction with the other [FORMat Command Subsystem](#) commands (they are not mutually exclusive).
  - The relative format readings provide a faster reading speed than the absolute format readings.
  - The absolute format time is based on the real-time clock of the instrument set by the [SYSTem:DATE](#) and [SYSTem:TIME](#) commands.
  - This setting is stored in the volatile memory (refer to [Appendix D: Volatile Memory](#)) and the time stamp type will be reset to RELative when the power is turned off or after a Factory Reset (the [\\*RST](#) command).

**Return** The query returns ABS or REL.

**Format**

**Example** FORM:READ:TIME:TYPE ABS  
FORM:READ:TIME:TYPE?

The query returns ABS.

**FORMat:READing:UNIT**

**Syntax** FORMat:READing:UNIT <mode>

FORMat:READing:UNIT?

**Description** Disable or enable the measurement unit in the return readings of the scan result query commands (such as the [READ?](#) command, the [R?](#) command and the [FETCh?](#) command).

**Parameters**

Name	Type	Range	Default
<mode>	Bool	{OFF 0 ON 1}	OFF

**Explanation**

- The setting applies to all the readings acquired in the scan. You cannot set the reading format on a per-channel basis.
- This command operates in conjunction with the other [FORMat Command Subsystem](#) commands (they are not mutually exclusive).
- This setting is stored in the volatile memory (refer to [Appendix D: Volatile Memory](#)) and will be disabled (OFF) when the power is turned off or after a Factory Reset (the [\\*RST](#) command).

**Return** The query returns 0 (OFF) or 1 (ON).

**Format Example**

FORM:READ:UNIT ON  
FORM:READ:UNIT?  
The query returns 1.



## IEEE-488.2 Common Commands

IEEE-488.2 standard defines a set of common commands which are used for the reset, self-test and status operations. These commands usually start with an asterisk (\*) and contain three characters as well as one or more parameters. the command keyword and the first parameter are separated by a space.

- [\\*CLS](#)
- [\\*ESE](#)
- [\\*ESR?](#)
- [\\*IDN?](#)
- [\\*OPC](#)
- [\\*PSC](#)
- [\\*RST](#)
- [\\*SAV](#)
- [\\*RCL](#)
- [\\*SRE](#)
- [\\*STB?](#)
- [\\*TRG](#)
- [\\*WAI](#)

### \*CLS

**Syntax** \*CLS

**Description** Clear the event registers, error queues and alarm queues in all the register sets, but it does not clear the enable registers.

**Related commands** [\\*ESR?](#)  
[STATus:QUEStionable\[:EVENT\]?](#)  
[STATus:OPERation\[:EVENT\]?](#)

**\*ESE**

**Syntax** \*ESE <enable\_val>

\*ESE?

**Description** Set the enable register for the Standard Event Register set.

**Parameters**

Name	Type	Range	Default
<enable_val>	Numeric	0 to 255	0

**Explanation**

- The definition of each bit in the Standard Event Register is as shown in the table below. Wherein, bit1 and bit6 are not used and are always regarded as 0. Therefore, the range of <enable\_val> are the decimal numbers corresponding to the binary numbers ranging from 00000000 (0 in decimal) to 11111111 (255 in decimal) and of which bit1 and bit6 are 0.

Bit	Weight	Name	Explanation
7	128	Power On	Power has been turned off and on since the last time the event register was read or cleared.
6	Not Used	Not Used	Always be 0.
5	32	Command Error	A command error occurred.
4	16	Execution Error	An execution error occurred.
3	8	Device Error	A device-specific error has been generated.
2	4	Query Error	A query error has been generated. In the following situations, query errors will be generated: the instrument tried to read the output buffer but it was empty; a new command line was received before a previous query has been read; both the input and output buffers are full.
1	Not Used	Not Used	Always be 0.
0	1	Operation Complete	All the commands prior to and including the *_OPC command have been executed.

**Return Format** The query returns an integer that corresponds to the binary-weighted sum of all the bits set in the register. For example, if bit 4 (decimal value = 16) and bit 7 (decimal value = 128) are enabled, the query will return 144.

**Example** \*ESE 144  
\*ESE?

The query returns 144.

**Related command** [\\*ESR?](#)

**\*ESR?****Syntax** \*ESR?**Description** Query the event register of the Standard Event Register set.

- Explanation**
- The corresponding bits in the event register must be enabled using the [\\*ESE](#) command. This command queries and clears the event register of the Standard Event Register set.
  - The definition of each bit in the Standard Event Register is as shown in the table below. Wherein, bit1 and bit6 are not used and are always regarded as 0. Therefore, the range of <enable\_val> are the decimal numbers corresponding to the binary numbers ranging from 00000000 (0 in decimal) to 11111111 (255 in decimal) and of which bit1 and bit6 are 0.

Bit	Weight	Name	Explanation
7	128	Power On	Power has been turned off and on since the last time the event register was read or cleared.
6	Not Used	Not Used	Always be 0.
5	32	Command Error	A command error occurred.
4	16	Execution Error	An execution error occurred.
3	8	Device Error	A device-specific error has been generated.
2	4	Query Error	A query error has been generated. In the following situations, query errors will be generated: the instrument tried to read the output buffer but it was empty; a new command line was received before a previous query has been read; both the input and output buffers are full.
1	Not Used	Not Used	Always be 0.
0	1	Operation Complete	All the commands prior to and including the <a href="#">*OPC</a> command have been executed.

**Return Format** The query returns an integer that corresponds to the binary-weighted sum of all bits set in the register. For example, if bit 4 (decimal value = 16) and bit 7 (decimal value = 128) are enabled, the query will return 144.

**Related command** [\\*CLS](#)

**\*IDN?****Syntax** \*IDN?**Description** Query the ID string of the instrument (including the manufacturer name, model and version number).

**Return Format** The query returns the ID string in the form of RIGOL TECHNOLOGIES,M300,<serial number>,XX.XX.XX.XX.XX.XX.XX

Wherein, <serial number> represents the instrument serial number, XX.XX.XX.XX.XX.XX.XX represents the instrument software version number.

**Example** \*IDN?

The query returns RIGOL TECHNOLOGIES,M300,M300123123123,07.08.00.01.00.00.17.

**Related commands** [SYSTem:IDN](#)  
[SYSTem:IDN:DEFault](#)

**\*OPC****Syntax** \*OPC

\*OPC?

**Description** The \*OPC command set bit 0 of the enable register of the Standard Event Register to 1 at the end of the current scan.

The \*OPC? command queries whether the current operation is completed or not. If yes, it returns 1 to the output buffer.

- Explanation**
- This command enables you to synchronize your application with the instrument.
  - Note the difference between the \*OPC command and the \*OPC? command. The \*OPC? command queries whether the current operation is completed or not. If yes, it returns 1 to the output buffer.

**Return Format** The query returns 1 when the current operation was completed; otherwise, returns 0.**\*PSC****Syntax** \*PSC <state>

\*PSC?

**Description** Enable or disable the clearing of the enable register of each register set at power on.**Parameters**

Name	Type	Range	Default
<state>	Bool	{OFF 0 ON 1}	ON

- Explanation**
- OFF|0: the enable registers are not cleared at power on; ON|1: the enable registers are cleared at power on (does not affect the condition register and event register).
  - The following registers are affected:
    - Questionable Status Register set
    - Standard Event Register set
    - Operation Status Register set
    - Alarm Register set
    - Status Byte Register set

**Return Format** The query returns 0 (do not clear at power on) or 1 (clear at power on).**\*RST****Syntax** \*RST**Description** Reset the instrument to the factory settings

- Explanation**
- For the factory settings, refer to [Appendix A: Factory](#).
  - This command does not affect the I/O settings, such as the IP address.

**\*SAV****\*RCL**

**Syntax** \*SAV {0|1|2|3|4|5}

\*RCL {0|1|2|3|4|5}

**Description** The \*SAV command stores the current measurement configuration to the specified location and overwrites any file previously stored in the current storage location (no error is generated). The \*RCL command recalls the measurement file stored in the specified location and overwrites the current measurement configuration.

- Explanation**
- The instrument has six storage locations in the non-volatile memory (refer to [Appendix C: Non-volatile Memory](#)) for the measurement configuration. You can store the current measurement configuration into the measurement configuration file in any of the six storage locations (named location 0, 1, 2, 3, 4, and 5. The default file names corresponding to the locations are 0\_STATE0, 1\_STATE1, 2\_STATE2, 3\_STATE3, 4\_STATE4 and 5\_STATE5).
  - The extension of the measurement configuration file is ".mfg".
  - The measurement configuration stores the scan list settings (include the trigger count, trigger mode, interval for auto trigger mode and trigger edge type for external trigger) and the channel configurations (include the measurement configuration, scalling configuration, alarm configuration and advanced configuration).
  - When shipped from the factory, all the measurement configuration files in the six storage locations are empty.
  - If the measurement configuration file of the specified location dose not exist (Sending the [SYSTEM:SECurity\[:IMMEDIATE\]](#) command will delete all the files of the memory) , you can send the [\\*SAV](#) command to create the measurement configuration file of the specified location.
  - A Factory Reset (the [\\*RST](#) command) does not affect the measurement configuration file stored in the specified location. Sending the [SYSTEM:SECurity\[:IMMEDIATE\]](#) command will delete all the measurement configuration files of the memory.

**Related Commands** [MEMory:STATe:DELeTe](#)  
[MEMory:STATe:NAME](#)  
[MEMory:STATe:VALId?](#)

**\*SRE****Syntax** \*SRE <enable\_val>

\*SRE?

**Description** Set the enable register of the Status Byte Register set.**Parameters**

Name	Type	Range	Default
<enable_val>	Numeric	0 to 255	0

**Explanation**

- The definition of each bit in the Status Byte Register is as shown in the table below. Wherein, bit0 is not used and is always regarded as 0. Therefore, the range of <enable\_val> are the decimal numbers corresponding to the binary numbers ranging from 00000000 (0 in decimal) to 11111111 (255 in decimal) and of which bit0 is 0.

Bit	Weight	Name	Explanation
7	128	Standard Operation Summary	One or more bits are set in the Operation Status Register (bits must be enabled, refer to the <a href="#">STATus:OPERation:ENABLE</a> command).
6	64	Master Summary	One or more bits are set in the Status Byte Register.
5	32	Standard Event Status Summary	One or more bits are set in the Standard Event Status Register (bits must be enabled, refer to the <a href="#">*ESE</a> command).
4	16	Message Available	Data is available in the output buffer of the instrument.
3	8	Questionable Status Summary	One or more bits are set in the Questionable Status Register (bits must be enabled, refer to the <a href="#">STATus:QUESTionable:ENABLE</a> command).
2	4	Error Queue	One or more errors have been stored in the Error Queue.
1	2	Alarm Summary	One or more bits are set in the Alarm Register (the bits must be enabled, refer to the <a href="#">STATus:ALARm:ENABLE</a> command ).
0	Not Used	Not Used	Always be 0.

**Return Format**

The query returns an integer that corresponds to the binary-weighted sum of all the bits set in the register. For example, if bit 4 (decimal value = 16) and bit 7 (decimal value = 128) are enabled, the query will return 144.

**Example**

```
*SRE 144
*SRE?
```

The query returns 144.

**Related command**

[\\*STB?](#)

**\*STB?****Syntax** \*STB?**Description** Query the condition register of the Status Byte Register set.

**Explanation** > This command only reads the register, but does not clear it.

> The definition of each bit in the Status Byte Register is as shown in the table below. Wherein, bit0 is not used and is always regarded as 0. Therefore, the range of <enable\_val> are the decimal numbers corresponding to the binary numbers ranging from 00000000 (0 in decimal) to 11111111 (255 in decimal) and of which bit0 is 0.

Bit	Weight	Name	Explanation
7	128	Standard Operation Summary	One or more bits are set in the Operation Status Register (bits must be enabled, refer to the <a href="#">STATUS:OPERation:ENABLE</a> command).
6	64	Master Summary	One or more bits are set in the Status Byte Register.
5	32	Standard Event Status Summary	One or more bits are set in the Standard Event Status Register (bits must be enabled, refer to the <a href="#">*ESE</a> command).
4	16	Message Available	Data is available in the output buffer of the instrument.
3	8	Questionable Status Summary	One or more bits are set in the Questionable Status Register (bits must be enabled, refer to the <a href="#">STATUS:QUESTIONable:ENABLE</a> command).
2	4	Error Queue	One or more errors have been stored in the Error Queue.
1	2	Alarm Summary	One or more bits are set in the Alarm Register (bits must be enabled, refer to the <a href="#">STATUS:ALARm:ENABLE</a> command ).
0	Not Used	Not Used	Always be 0.

**Return Format** The query returns an integer that corresponds to the binary-weighted sum of all bits set in the register. For example, if bit 4 (decimal value = 16) and bit 7 (decimal value = 128) are enabled, the query will return 144.

**Related command** [\\*SRE](#)

**\*TRG****Syntax** \*TRG

**Description** The instrument generates a trigger (measures all the channels in the scan list and then waits for the next trigger) each time this command is received when the instrument is in manual trigger mode (refer to the [TRIGger:SOURce](#) command) and is waiting for a trigger (send the [INITiate](#) command).

**Explanation** The \*TRG command does not work with the [READ?](#) command.

**Example** TRIG:SOUR BUS  
INIT  
\*TRG  
R?

**\*WAI****Syntax** \*WAI**Description** Control the instrument to execute other commands on the interface after all the pending operations are completed.**Explanation**

- Function and range changes are considered as pending operations. Therefore, the \*WAI command will wait for these changes to complete.
- As this command stops the command parser from operating, it is better to use the [\\*OPC](#) for synchronization purposes.

**Example**

```
INIT
*WAI
ROUT:CLOS (@101)
```



## INITiate

**Syntax** INITiate

**Description** This command changes the state of the triggering system from the "idle" state to the "wait-for-trigger" state. Scan will begin when the specified trigger conditions are satisfied. Readings acquired during the scan are stored in the internal reading memory of the instrument. Note that the INITiate command also clears the previous scan readings from the memory. If the scan list was defined (refer to the [ROUTE:SCAN](#) command ) already, the INITiate command will scan the specified channel in the scan list. If the scan list was not defined, an error will be generated when sending the INITiate command.

- Explanation**
- Storing the readings into the memory using the INITiate command is generally faster than sending the readings to the memory using the [READ?](#) command. The INITiate command is also an "overlapped" command, namely after sending the INITiate command, you can send other commands that do not affect the measurements.
  - When scanning the multiplexer channels, an error is generated if the DMM module is disabled (refer to the [INSTRUMENT:DMM](#) command) or not installed in the mainframe and the advanced source mode is disabled. The DMM module is not required when scanning the multifunction module channels.
  - When the scan is initiated, the instrument will open all the channels of the module of the multiplexer channel in the scan list.
  - The instrument scans the list of channels in ascending order from Slot1 through slot 5. The instrument stores the channel numbers in ascending order even when you have already defined the order of the channels in the scan list. For Example, when the channel numbers in the scan list are defined as (@109:101), the instrument stores the channel numbers in 101, 102, 103... order.
  - Once the trigger status of the instrument changes from "Idle" to "Wait-for -trigger", an error will be generated if you attempt to change any measurement parameters (send the [CONFigure Command Subsystem](#) and [SENSe Command Subsystem](#) commands) or the triggering configuration (send the [TRIGger Command Subsystem](#) commands). To abort a scan in progress, send the [ABORT](#) command.

**Example**

```
CONF:VOLT:DC 20,DEF,(@401:403)
ROUT:SCAN (@401:403)
TRIG:SOUR BUS
INIT
*TRG
FETC?
```

## INPut:IMPedance:AUTO

**Syntax** INPut:IMPedance:AUTO <state>[,(@<ch\_list>)]

INPut:IMPedance:AUTO? [(@<ch\_list>)]

**Description** Enable or disable the impedance automatic input mode for the DCV measurements on the specified channels.

Parameters	Name	Type	Range	Default
	<state>	Bool	{OFF 0 ON 1}	OFF
	<ch_list>	Channel List	One or more channels (only for the multiplexer channels), the rules are as follows: (@101): channel 01 on the module in Slot1; (@101:103): channel 01 through 03 on the module in Slot1; (@101:103,301): channel 01 through 03 on the module in Slot1 and channel 01 on the module in Slot3.	If the parameter is omitted, this command will be applied to the whole scan list.

- Explanation**
- By default, the impedance automatic input is disabled. At this point, the input impedance is fixed at 10 MΩ for all the DCV ranges.
  - When the impedance automatic input is enabled, the input impedance are set to >10 GΩ automatically on the 200 mV, 2 V and 20 V ranges and are set to 10 MΩ automatically on the ranges greater than 20V.
  - The impedance automatic input mode will be disabled (OFF) after a Factory Reset (the [\\*RST](#) command).

**Return Format** The query returns 0 (OFF) or 1 (ON). Multiple return values are separated by commas.

**Example** INP:IMP:AUTO ON,(@101)  
INP:IMP:AUTO? (@101)

The query returns 1.

## INSTRument Command Subsystem

- [INSTRument:DMM](#)
- [INSTRument:DMM:INSTalled?](#)

### INSTRument:DMM

**Syntax** INSTRument:DMM <state>

INSTRument:DMM?

**Description** Enable or disable the DMM module.

**Parameters**

Name	Type	Range	Default
<state>	Bool	{OFF 0 ON 1}	None

- Explanation**
- When you change the state of the DMM module, the instrument will initiate the current scan list.
  - The setting command is valid only when the DMM module is installed (refer to the [INSTRument:DMM:INSTalled?](#) command). If the DMM module is not currently installed, the query returns 0.

**Return Format** The query returns 0 (OFF) or 1 (ON).

**Example** INSTR:DMM ON  
INSTR:DMM?  
The query returns 1.

### INSTRument:DMM:INSTalled?

**Syntax** INSTRument:DMM:INSTalled?

**Description** Query whether the DMM module is installed.

**Return Format** The query returns 0 (not installed) or 1 (installed).

**Example** INSTR:DMM:INST?  
The query returns 1.

**Related command** [INSTRument:DMM](#)

## LXI Command Subsystem

- [LXI:IDENTify\[:STATE\]](#)
- [LXI:RESet](#)
- [LXI:REStart](#)

### LXI:IDENTify[:STATE]

**Syntax** LXI:IDENTify[:STATE] <state>

LXI:IDENTify[:STATE]?

**Description** Turn the LXI identification indicator on the front panel display on or off.

**Parameters**

Name	Type	Range	Default
<state>	Bool	{OFF 0 ON 1}	None

**Explanation**

- This command is valid only when M300 has been connected to the network using a LAN cable.
- You can press  to turn off the LXI identification indicator.
- The instrument turns off the LXI identification indicator after a Factory Reset (send the [\\*RST](#) command).

**Return Format** The query returns 0 (OFF) or 1 (ON).

**Example** LXI:IDEN:STATE 1  
LXI:IDEN:STATE?

The query returns 1.

**Related command** [LXI Command Subsystem](#)

### LXI:RESet

**Syntax** LXI:RESet

- Description**
- Reset the LAN settings to their default values.
  - The default values are as below:  
DHCP: ON  
AutoIP: ON  
ManualIP: OFF

### LXI:REStart

**Syntax** LXI:REStart

**Description** Restart the LAN with the current parameters.

## MEASure Command Subsystem

- [MEASure:ANYSensor?](#)
- [MEASure:CURR:AC?](#)
- [MEASure:CURR\[:DC\]?](#)
- [MEASure:DIgital:BYTE?](#)
- [MEASure:DIgital:DWORD?](#)
- [MEASure:DIgital:WORD?](#)
- [MEASure:FREQuency?](#)
- [MEASure:PERiod?](#)
- [MEASure:TEMPerature?](#)
- [MEASure:TOTalize?](#)
- [MEASure:VOLTag:AC?](#)
- [MEASure:VOLTag\[:DC\]?](#)

### MEASure:ANYSensor?

**Syntax** MEASure:ANYSensor? [{<type>|DEF},,](@<scan\_list>)

**Description** Configure the specified channels to the specified type of anysensor measurement function, start a scan and read the readings.

Parameters	Name	Type	Range	Default
	<type>	Discrete	{VOLT CURR FREQ}	VOLT or CURR <sup>[1]</sup>
	<scan_list>	Scan List	One or more channels (only for the multiplexer channels), the rules are as follows: (@101): channel 01 on the module in Slot1; (@101:103): channel 01 through 03 on the module in Slot1; (@101:103,301): channel 01 through 03 on the module in Slot1 and channel 01 on the module in Slot3.	None

**Note**<sup>[1]</sup>: When the parameter is set to DEF or is omitted, for channel 21 through channel 24 of MC3324, the anysensor type is set to DCI; for other multiplexer channels, the anysensor type is set to DCV.

- Explanation**
- This command is equivalent to the [CONFigure:ANYSensor](#) command followed by the [READ?](#) command.
  - The values of <type> correspond to the following measurement functions respectively.  
VOLT: DCV; CURR: DCI; FREQ: FREQ.
  - <scan\_list> can only be the multiplexer channels.  
For channel 21 to channel 24 of MC3324, <type> can only be CURR;  
For all the channels of MC3164, <type> can not be CURR;  
For other multiplexer channels, <type> can not be CURR.
  - <scan\_list> overwrites the current scan list.

**Return Format** The query returns the readings in scientific notation. Multiple return values are separated by commas.

**Example** MEAS:ANYS? DEF,(@101)

The query returns +2.604997287E-03.

## MEASure:CURR:AC?

**Syntax** MEASure:CURR:AC? [{<range>|AUTO|MIN|MAX|DEF}][,<resolution>|MIN|MAX|DEF}], (@<scan\_list>)

**Description** Configure the specified channels to the ACI measurement function with the specified range and resolution, start a scan and read the readings.

Parameters	Name	Type	Range	Default
	<range>	Numeric	Any numeric value between 0 and 110*MAX. The final range is decided by the " <b>Principle of setting with greater value</b> " when <range> is between 0 and MAX; the final range is MAX when <range> is greater than MAX. The standard values of the range: {200μA 2mA 20mA 200mA 1A} Wherein: MIN=200μA, MAX=1A, DEF=AUTO.	AUTO
	<resolution>	Numeric	Can receive any numeric value or any of {MIN MAX DEF}, but the resolution is fixed at 6 <sup>1/2</sup> digits.	
	<scan_list>	Scan List	One or more channels (only for channel 21 to channel 24) of MC3324, the rules are as follows: (@121): channel 21 on the module in Slot1; (@121:123): channel 21 through 23 on the module in Slot1; (@121:123,321): channel 21 to 23 on the module in Slot1 and channel 21 on the module in Slot3.	None

- Explanation**
- This command is equivalent to the [CONFigure:CURRent:AC](#) command followed by the [READ?](#) command.
  - This command is only applicable to channel 21 to channel 24 of MC3324. When <scan\_list> is set to other channels, an error will be generated.
  - You can select autoranging to allow the instrument to automatically select a proper measurement range or you can select a fixed range to set the range manually.
  - Autoranging rule: for signals under test that is between 10%\*Range and 110%\*Range, the instrument automatically selects Range as the current range.
  - When <range> is set to DEF or AUTO, an error will be generated if <resolution> is set to a numeric value, because the instrument cannot calculate the integration time accurately (especially when the input signal is continuously changing) when the autoranging is combined with a numeric resolution. If your application requires autoranging, be sure to specify "DEF" for <resolution> or omit the parameter.
  - If the input signal is greater than can be measured on the selected range, the instrument gives an overload indication: "OVERLOAD" from the front panel or "±9.9E+37" from the remote interface.
  - <scan\_list> overwrites the current scan list.

**Return Format** The query returns the readings in scientific notation. Multiple return values are separated by commas.

**Example** MEAS:CURR:AC? MAX,DEF,(@221,222)

The query returns +3.373913517E-01,+3.346332554E-01.

## MEASure:CURR[:DC]?

**Syntax** MEASure:CURR[:DC]?  
[<range>|AUTO|MIN|MAX|DEF][, {<resolution>|MIN|MAX|DEF}], (@<scan\_list>)

**Description** Configure the specified channels to the DCI measurement function with the specified range and resolution, start a scan and read the readings.

Parameters	Name	Type	Range	Default
	<range>	Numeric	Any numeric value between 0 and 110*MAX. The final range is decided by the " <b>Principle of setting with greater value</b> " when <range> is between 0 and MAX; the final range is MAX when <range> is greater than MAX. The standard values of the range: {200μA 2mA 20mA 200mA 1A} Wherein: MIN=200μA, MAX=1A, DEF=AUTO.	AUTO
	<resolution>	Numeric	Can receive any numeric value between 0.03ppm×<range> and 3ppm×<range>. The final resolution is decided by the " <b>Principle of setting with smaller value</b> ". The standard values of the resolution: refer to the " <b>Explanation</b> ".	0.3ppm×<range>
	<scan_list>	Scan List	One or more channels (only for channel 21 to channel 24 of MC3324), the rules are as follows: (@121): channel 21 on the module in Slot1; (@121:123): channel 21 through 23 on the module in Slot1; (@121:123,321): channel 21 through 23 on the module in Slot1 and channel 21 on the module in Slot3.	None

- Explanation**
- This command is equivalent to the [CONFigure:CURRent\[:DC\]](#) command followed by the [READ?](#) command.
  - This command is only applicable to channel 21 to channel 24 of MC3324. When <scan\_list> is set to other channels, an error will be generated.
  - You can select autoranging to allow the instrument to automatically select a proper measurement range or you can select a fixed range to set the range manually.
  - Autoranging rule: for signals under test that is between 10%\*Range and 110%\*Range, the instrument automatically selects Range as the current range.
  - When <range> is set to DEF or AUTO, an error will be generated if <resolution> is set to a numeric value, because the instrument cannot calculate the integration time accurately (especially when the input signal is continuously changing) when the autoranging is combined with a numeric resolution. If your application requires autoranging, be sure to specify "DEF" for <resolution> or omit the parameter.
  - <resolution> is related to the current integration time and range (<range>). The relations are as shown in the table below.

Integration time	Resolution (ppm range)
0.02PLC	3ppm× <range> (MAX)
0.2PLC	0.7ppm× <range>

1PLC	0.3ppm× <range> (DEF)
2PLC	0.2ppm× <range>
10PLC	0.1ppm× <range>
20PLC	0.06ppm× <range>
100PLC	0.035ppm× <range>
200PLC	0.03ppm× <range> (MIN)
Aperture Time Mode	0.03ppm× <range> (MIN)

- If the input signal is greater than can be measured on the selected range, the instrument gives an overload indication: "OVERLOAD" from the front panel or "±9.9E+37" from the remote interface.
- <scan\_list> overwrites the current scan list.

**Return Format** The query returns the readings in scientific notation. Multiple return values are separated by commas.

**Example** MEAS:CURR:DC? AUTO,DEF,(@121:122)  
The query returns +3.373913517E-01,+3.346332554E-01.

## MEASure:DIGital:BYTE?

## MEASure:DIGital:DWORD?

## MEASure:DIGital:WORD?

**Syntax** MEASure:DIGital:BYTE? (@<scan\_list>)  
MEASure:DIGital:DWORD? (@<scan\_list>)  
MEASure:DIGital:WORD? (@<scan\_list>)

**Description** Set the bits of the DIO channels when they are used as the digital input terminals (BYTE represents 8-bit, WORD represents 16-bit and DWORD represents 32-bit), start a scan and read the readings.

Parameters	Name	Type	Range	Default
	<scan_list>	Scan List	One or more channels (only for the 01 channel through 04 of MC3534), the rules are as follows: (@101): channel 01 on the module in Slot1; (@101:103): channel 01 through 03 on the module in Slot1; (@101:103,301): channel 01 through 03 on the module in Slot1 and channel 01 on the module in Slot3.	None

**Explanation**

- These commands are equivalent to the [CONFigure:DIGital:BYTE](#), [CONFigure:DIGital:WORD](#) or [CONFigure:DIGital:DWORD](#) command followed by the [READ?](#) command.
- The digital input channels are numbered as "S01" to "S04"; wherein, S is the number of the slot of the multifunction module.
- The MEASure:DIGital:BYTE? (@<scan\_list>) command is applicable to S01 to S04.  
The MEASure:DIGital:WORD? (@<scan\_list>) command is applicable to S01 and S03. At this point, S01 (LSB) and S02 (MSB) as well as S03 (LSB) and S04 (MSB) are configured as two 16-bit digital input terminals.  
The MEASure:DIGital:DWORD? (@<scan\_list>) command is applicable to S01. At this point, S01 (LSB), S02, S03 and S04 (MSB) are configured as a 32-bit digital input



terminal.

If the <scan\_list> parameter configured does not match the above rules, an error will be generated.

- <scan\_list> overwrites the current scan list.

**Return Format** The query returns the readings in scientific notation. Multiple return values are separated by commas.

**Example** MEAS:DIG:WORD? (@401,403)

The query returns +6.553500000E+04,+6.553500000E+04.

## MEASure:FREQuency?

## MEASure:PERiod?

**Syntax** MEASure:FREQuency?  
 [{<range>|AUTO|MIN|MAX|DEF},{<resolution>|MIN|MAX|DEF},] (@<scan\_list>)  
 MEASure:PERiod? [{<range>|AUTO|MIN|MAX|DEF},{<resolution>|MIN|MAX|DEF},]  
 (@<scan\_list>)

**Description** Configure the specified channels to the frequency or period measurement functions with the specified gate time, start a scan and read the readings.

**Parameters**

Name	Type	Range	Default
<range>	Discrete	Can receive any numeric value or any of {AUTO MIN MAX DEF}. This parameter is unnecessary for the frequency and period measurements, the instrument only receives the parameter but does not respond to it.	AUTO
<resolution>	Numeric	This parameter sets the gate time. It can be any numeric value between MIN and MAX. The final gate time is decided by the " <b>Principle of setting with greater value</b> ". The standard values of the gate time: {1ms 10ms 100ms 1s} Wherein: MIN=1ms, MAX=1s, DEF=100ms.	100ms
<scan_list>	Scan List	One or more channels (only for the multiplexer channels), the rules are as follows: (@101): channel 01 on the module in Slot1; (@101:103): channel 01 to channel 03 on the module in Slot1; (@101:103,301): channel 01 to channel 03 on the module in Slot1 and channel 01 on the module in Slot3;	None

**Explanation**

- These commands are equivalent to the [CONFigure:FREQuency](#) or [CONFigure:PERiod](#) command followed by the [READ?](#) command.
- <scan\_list> overwrites the current scan list.

**Return Format** The query returns the readings in scientific notation. Multiple return values are separated by commas.

**Example** MEAS:FREQ? AUTO,DEF,(@101:102)

The query returns +1.014640780E+03,+9.748052293E+02.

## MEASure:TEMPerature?

**Syntax** MEASure:TEMPerature?  
{<probe\_type>|DEF},{<type>|DEF}[,1[,<resolution>|MIN|MAX|DEF]],(@<scan\_list>)

**Description** Configure the specified channels to the temperature measurement function, start a scan and read the readings.

### Parameters

Name	Type	Range	Default
<probe_type>	Discrete	{TCouple THERmistor RTD FRTD}	TC
<type>	Discrete	TCouple	{B E J K N R S T}
		THERmistor	{2252 3000 5000 10000 30000}
		RTD	{85 89 91 92}
		FRTD	{85 89 91 92}
<resolution>	Numeric	Can receive any numeric value. This parameter is unnecessary for the command. The instrument only receives the parameter but does not respond to it.	
<scan_list>	Scan List	One or more channels (only for the multiplexer channels), the rules are as follows: (@101): channel 01 on the module in Slot1; (@101:103): channel 01 through 03 on the module in Slot1; (@101:103,301): channel 01 through 03 on the module in Slot1 and channel 01 on the module in Slot3.	None

- Explanation**
- This command is equivalent to the [CONFigure:TEMPerature](#) command followed by the [READ?](#) command.
  - For all the channels of MC3164, <probe\_type> can not be set to FRTD (4-wire RTD).
  - If <probe\_type> is specified as FRTD, channel n is paired with channel n+16 (for MC3132, the range of n is from 1 to 16) or n+10 (for MC3324, MC3120 and MC3120A, the range of n is from 1 to 10) automatically. Channel n is used to connect the source terminal of the DMM and channel n+16 or channel n+10 is used to connect the sense terminal of the DMM. The paired channels cannot be configured.
  - For the temperature measurements, the instrument will select the range; therefore, you do not need to select the range. Make sure that the command contains "1" (before <resolution>; it is used to replace <range>).
  - If the input signal is greater than can be measured on the selected range, the instrument gives an overload indication: "OVERLOAD" from the front panel or "±9.9E+37" from the remote interface.
  - When <probe\_type> is TCouple, if T/C Check is currently enabled and no thermocouple is connected, the measurement result is "OVERLOAD" and "±9.9E+37" will be returned in remote control. Note that at this point, the measurement value is not the value of the temperature under measurement.
  - <scan\_list> overwrites the current scan list.

**Return Format** The query returns the readings in scientific notation. Multiple return values are separated by commas.

**Example** MEAS:TEMP? DEF,DEF,1,DEF,(@101)

The query returns +2.411291906E+01.

## MEASure:TOTalize?

**Syntax** MEASure:TOTalize? [<mode>],(@<scan\_list>)

**Description** Set the reading mode of the specified TOT channel, start a scan and read the readings.

**Parameters**

Name	Type	Range	Default
<mode>	Discrete	{READ RRESet}	READ
<scan_list>	Scan List	One or more channels (only for the TOT channels), the rules are as follows: (@105): channel 05 on the module in Slot1; (@105:108): channel 05 through 08 on the module in Slot1; (@105:108,305): channel 05 through 08 on the module in Slot1 and channel 05 on the module in Slot3.	None

- Explanation**
- This command is equivalent to the [CONFigure:TOTalize](#) command followed by the [READ?](#) command.
  - The totalizer channels are numbered as "S05" to "S08"; wherein, S is the number of the slot.
  - <mode> is used to set the reading mode of the TOT channel. READ denotes reading the readings without resetting the count value; RRESet denotes reading the readings and resetting the count value (namely Read and Reset).
  - The maximum count of each TOT channel is  $42,9496,7295(2^{32} - 1)$ . The count rolls over to 0 after reaching the maximum allowed value.
  - Selecting the RRESet mode performs a synchronized read and reset operation on the specified totalizer channels. If you were to use discrete commands, such as the [READ?](#) and [\[SENSe:\]TOTalize:CLear:IMMediate](#) command, you would likely lose counts occurring between the two commands.
  - <scan\_list> overwrites the current scan list.

**Return Format** The query returns the readings in scientific notation. Multiple return values are separated by commas.

**Example** MEAS:TOT? READ,(@405)

The query returns +1.200000000E+01.

## MEASure:VOLTage:AC?

**Syntax** MEASure:VOLTage:AC? [{<range>|AUTO|MIN|MAX|DEF}],{<resolution>|MIN|MAX|DEF},] (@<scan\_list>)

**Description** Configure the specified channels to the ACV measurement function with the specified range and resolution, start a scan and read the readings.

**Parameters**

Name	Type	Range	Default
<range>	Numeric	Any numeric value between 0 and 110*MAX. The final range is decided by the " <b>Principle of setting with greater value</b> " when <range> is between 0 and MAX; the final range is MAX when <range> is greater than MAX. The standard values of the range: {200mV 2V 20V 200V 300V}, wherein, MIN=200mV, MAX=300V, DEF=AUTO.	AUTO

<resolution>	Numeric	Can receive any numeric value, but the resolution is fixed at 6 <sup>1</sup> / <sub>2</sub> digits.	
<scan_list>	Scan List	One or more channels (only for the multiplexer channels), the rules are as follows: (@101): channel 01 on the module in Slot1; (@101:103): channel 01 through 03 on the module in Slot1; (@101:103,301): channel 01 through 03 on the module in Slot1 and channel 01 on the module in Slot3.	None

- Explanation**
- This command is equivalent to the [CONFigure:VOLTage:AC](#) command followed by a [READ?](#) command.
  - You can select autoranging to allow the instrument to automatically select a proper measurement range or you can select a fixed range to set the range manually.
  - Autoranging rule: for signals under test that is between 10%\*Range and 110%\*Range, the instrument automatically selects Range as the current range.
  - When <range> is set to DEF or AUTO, an error will be generated if <resolution> is set to a numeric value, because the instrument cannot calculate the integration time accurately (especially when the input signal is continuously changing) when the autoranging is combined with a numeric resolution. If your application requires autoranging, be sure to specify "DEF" for <resolution> or omit the parameter.
  - If the input signal is greater than can be measured on the selected range, the instrument gives an overload indication: "OVERLOAD" from the front panel or "±9.9E+37" from the remote interface.
  - <scan\_list> overwrites the current scan list.

**Return Format** The query returns the readings in scientific notation. Multiple return values are separated by commas.

**Example** MEAS:VOLT:AC? AUTO,DEF,(@101)  
The query returns +9.689453687E-02.

## MEASure:VOLTage[:DC]?

**Syntax** MEASure:VOLTage[:DC]?  
[<range>|AUTO|MIN|MAX|DEF][,]<resolution>|MIN|MAX|DEF][,]<scan\_list>

**Description** Configure the specified channels to the DCV measurement function with the specified range and resolution, start a scan and read the readings.

Parameters	Name	Type	Range	Default
	<range>	Numeric	Any numeric value between 0 and 110*MAX. The final range is decided by the " <b>Principle of setting with greater value</b> " when <range> is between 0 and MAX; the final range is MAX when <range> is greater than MAX. The standard values of the range: {200mV 2V 20V 200V 300V}, wherein, MIN=200mV, MAX=300V, DEF=AUTO.	AUTO
	<resolution>	Numeric	Any numeric value between 0.03ppm×<range> and 3ppm×<range>. The final resolution is decided by the " <b>Principle of setting with smaller value</b> ".	0.3ppm×<range>

		The standard values of the resolution: Shown in the " <b>Explanation</b> " of this section.	
<scan_list>	Scan List	One or more channels (only for the multiplexer channels), the rules are as follows: (@101): channel 01 on the module in Slot1; (@101:103): channel 01 through 03 on the module in Slot1; (@101:103,301): channel 01 through 03 on the module in Slot1 and channel 01 on the module in Slot3.	None

- Explanation**
- This command is equivalent to the [CONFigure:VOLTage\[:DC\]](#) command followed by the [READ?](#) command.
  - You can select autoranging to allow the instrument to automatically select a proper measurement range or you can select a fixed range to set the range manually.
  - Autoranging rule: for signals under test that is between 10%\*Range and 110%\*Range, the instrument automatically selects Range as the current range.
  - When <range> is set to DEF or AUTO, an error will be generated if <resolution> is set to a numeric value, because the instrument cannot calculate the integration time accurately (especially when the input signal is continuously changing) when the autoranging is combined with a numeric resolution. If your application requires autoranging, be sure to specify "DEF" for <resolution> or omit the parameter.
  - <resolution> is related to the current integration time and range (<range>). The relations are as shown in the table below.

Integration time	Resolution (ppm range)
0.02PLC	3ppm× <range> (MAX)
0.2PLC	0.7ppm× <range>
1PLC	0.3ppm× <range> (DEF)
2PLC	0.2ppm× <range>
10PLC	0.1ppm× <range>
20PLC	0.06ppm× <range>
100PLC	0.035ppm× <range>
200PLC	0.03ppm× <range> (MIN)
Aperture Time Mode	0.03ppm× <range> (MIN)

- If the input signal is greater than can be measured on the selected range, the instrument gives an overload indication: "OVERLOAD" from the front panel or "±9.9E+37" from the remote interface.
- <scan\_list> overwrites the current scan list.

**Return Format** The query returns the readings in scientific notation. Multiple return values are separated by commas.

**Example** MEAS:VOLT:DC? AUTO,DEF,(@101)

The query returns +3.145222548E-03.

## MEMory Command Subsystem

- [MEMory:NSTates?](#)
- [MEMory:SAVE:SYSTem](#)
- [MEMory:NAME:SYSTem?](#)
- [MEMory:RECall:SYSTem](#)
- [MEMory:SAVE:CONFig](#)
- [MEMory:NAME:CONFig?](#)
- [MEMory:RECall:CONFig](#)
- [MEMory:SAVE:MIRRor](#)
- [MEMory:NAME:MIRRor?](#)
- [MEMory:RECall:MIRRor](#)
- [MEMory:SAVE:DATA](#)
- [MEMory:NAME:DATA?](#)
- [MEMory:RECall:DATA](#)
- [MEMory:STATE:DELeTe](#)
- [MEMory:STATE:NAME](#)
- [MEMory:STATE:RECall](#)
- [MEMory:STATE:VALid?](#)

### MEMory:NSTates?

**Syntax** MEMory:NSTates?

**Description** Query the total number of memory locations available for measurement configuration file storage.

**Return** The query returns +6.

**Format**

**Example** MEM:NST?

The query returns +6.

**Related** [\\*SAV](#)  
**Commands** [\\*RCL](#)  
[MEMory:STATE:DELeTe](#)  
[MEMory:STATE:NAME](#)  
[MEMory:STATE:RECall](#)  
[MEMory:STATE:VALid?](#)

## MEMory:SAVE:SYSTem

## MEMory:NAME:SYSTem?

## MEMory:RECall:SYSTem

**Syntax** MEMory:SAVE:SYSTem <name>  
 MEMory:NAME:SYSTem?  
 MEMory:RECall:SYSTem <name>

**Description** The SAVE command saves the current system configuration with the specified filename to the non-volatile memory (refer to [Appendix C: Non-volatile Memory](#)). The NAME command queries the filenames of all the system configuration files in the non-volatile memory. The RECall command recalls the specified system configuration file in the non-volatile memory and overwrites the current system configuration.

Parameters	Name	Type	Range	Default
	<name>	Filename	A string enclosed in double quotation marks or single quotation mark. It can contain up to 12 characters including English letters (a-z, A-Z), numbers (0-9) or Chinese characters <sup>[1]</sup> .	None

**Note**<sup>[1]</sup>: A Chinese character occupies two bytes.

- Explanation**
- The extension of the system configuration file is ".sfg".
  - The instrument generates an error if you specify a name with more than 12 characters.
  - Sending the MEMory:RECall:SYSTem <name> command will generate an error if the specified file does not exist.
  - The system configuration file includes the sound, screen saver, decimal point, separator, power key and brightness.
  - A Factory Reset (the [\\*RST](#) command) does not affect the system configuration file. Sending the [SYSTem:SECurity\[:IMMediate\]](#) command will delete all the system configuration files in the non-volatile memory.

**Return Format** The query returns the filename with the ".sfg" extension and enclosed in double quotation marks. Multiple return values are separated by commas.

**Example** MEM:SAVE:SYST "20130708"  
 MEM:NAME:SYST?  
 MEM:REC:SYST "20130708"

The query returns "20130708.sfg".

**Related Command** [MEMory Command Subsystem](#)

## MEMory:SAVE:CONFig

## MEMory:NAME:CONFig?

## MEMory:RECall:CONFig

**Syntax** MEMory:SAVE:CONFig <name>

MEMory:NAME:CONFig?

MEMory:RECall:CONFig <name>

**Description** The SAVE command saves the current measurement configuration with the specified filename to the non-volatile memory (refer to [Appendix C: Non-volatile Memory](#)). The NAME command queries the filenames of all the measurement configuration files in the non-volatile memory. The RECall command recalls the specified measurement configuration file in the non-volatile memory and overwrites the current measurement configuration.

Parameters	Name	Type	Range	Default
	<name>	Filename	A string enclosed in double quotation marks or single quotation mark. It can contain up to 12 characters including English letters (a-z, A-Z), numbers (0-9) or Chinese characters <sup>[1]</sup> .	None

**Note**<sup>[1]</sup>: A Chinese character occupies two bytes.

- Explanation**
- The extension of the measurement configuration file is ".mfg".
  - The instrument generates an error if you specify a name with more than 12 characters.
  - Sending the MEMory:RECall:CONFig <name> command will generate an error if the specified file does not exist.
  - The measurement configuration includes the scan list settings (include the trigger count, trigger mode, interval for auto trigger mode and trigger edge type for external trigger) and the channel configurations (include the measurement configuration, scaling configuration, alarm configuration and advanced configuration).
  - A Factory Reset (the [\\*RST](#) command) does not affect the measurement configuration files. Sending the [SYSTem:SECurity\[:IMMediate\]](#) command will delete all the measurement configuration files in the non-volatile memory.

**Return Format** The query returns the filename with the ".mfg" extension and enclosed in double quotation marks. Multiple return values are separated by commas.

**Example** MEM:SAVE:CONF "20130708"  
MEM:NAME:CONF?  
MEM:REC:CONF "20130708"

The query returns "20130708.mfg".

**Related Command** [MEMory Command Subsystem](#)



## MEMory:SAVE:MIRRor

## MEMory:NAME:MIRRor?

## MEMory:RECall:MIRRor

**Syntax** MEMory:SAVE:MIRRor <name>

MEMory:NAME:MIRRor?

MEMory:RECall:MIRRor <name>

**Description** The SAVE command saves the current mirror configuration with the specified filename to the non-volatile memory (refer to [Appendix C: Non-volatile Memory](#)). The NAME command queries the filenames of all the mirror configuration files in the non-volatile memory. The RECall command recalls the specified mirror configuration file in the non-volatile memory and overwrites the current mirror configuration.

Parameters	Name	Type	Range	Default
	<name>	Filename	A string enclosed in double quotation marks or single quotation mark. It can contain up to 12 characters including English letters (a-z, A-Z), numbers (0-9) or Chinese characters <sup>[1]</sup> .	None

**Note**<sup>[1]</sup>: A Chinese character occupies two bytes.

- Explanation**
- The extension of the mirror configuration file is ".mir".
  - The instrument generates an error if you specify a name with more than 12 characters.
  - Sending the MEMory:RECall:MIRRor <name> command will generate an error if the specified file does not exist.
  - The system configuration and measurement configuration are combined into a single file, namely the mirror configuration file.
  - A Factory Reset (the [\\*RST](#) command) does not affect the mirror configuration files. Sending the [SYSTem:SECurity\[:IMMediate\]](#) command will delete all the mirror configuration files in the non-volatile memory.

**Return Format** The query returns the filename with the ".mir" extension and enclosed in double quotation marks. Multiple return values are separated by commas.

**Example** MEM:SAVE:MIRR "20130708"  
MEM:NAME:MIRR?  
MEM:REC:MIRR "20130708"

The query returns "20130708.mir".

**Related Command** [MEMory Command Subsystem](#)

## MEMory:SAVE:DATA

## MEMory:NAME:DATA?

## MEMory:RECall:DATA

**Syntax** MEMory:SAVE:DATA <name>  
 MEMory:NAME:DATA?  
 MEMory:RECall:DATA <name>

**Description** The SAVE command saves the current measurement data with the specified filename to the non-volatile memory (refer to [Appendix C: Non-volatile Memory](#)). The NAME command queries the filenames of all the measurement data files in the non-volatile memory. The RECall command recalls the specified measurement data file in the non-volatile memory and overwrites the current measurement data.

Parameters	Name	Type	Range	Default
	<name>	Filename	A string enclosed in double quotation marks or single quotation mark. It can contain up to 12 characters including English letters (a-z, A-Z), numbers (0-9) or Chinese characters <sup>[1]</sup> .	None

**Note**<sup>[1]</sup>: A Chinese character occupies two bytes.

- Explanation**
- The extension of the measurement data file is ".dat".
  - If there are no readings in the reading memory, sending the MEMory:SAVE:DATA <name> command will generate an error.
  - The instrument generates an error if you specify a name with more than 12 characters.
  - The system configuration file includes the readings (include the units, time stamp, channel number and alarm information (not affected by the [FORMat Command Subsystem](#) commands), max, min, average, sdev, peak to peak, scan start time and scan count.
  - A Factory Reset (the [\\*RST](#) command) does not affect the measurement data files. Sending the [SYSTem:SECurity\[:IMMediate\]](#) command will delete all the measurement data files in the non-volatile memory.

**Return Format** The query returns the filename with the ".dat" extension and enclosed in double quotation marks. Multiple return values are separated by commas.

**Example** MEM:SAVE:DATA "20130708"  
 MEM:NAME:DATA?  
 MEM:REC:DATA "20130708"  
 The query returns "20130708.dat".

**Related Command** [MEMory Command Subsystem](#)

## MEMory:STATe:DELeTe

**Syntax** MEMory:STATe:DELeTe <location>

**Description** Delete the contents of the measurement configuration file in the specified storage location.

**Parameters**

Name	Type	Range	Default
<location>	Discrete	{0 1 2 3 4 5}	None

- Explanation**
- If you have deleted the contents of the measurement configuration file in the specified storage location and then send the [\\*RCL](#) command to recall the contents of this file to overwrite the current measurement configuration, an error will be generated.
  - This command deletes the contents of the measurement configuration file in the specified storage location, but does not delete the file.
  - This command can only delete the file created by the [\\*SAV](#) command. It can not delete the file created by the [MEMory:SAVE:CONFig](#) command.
  - Sending this command will generate an error if the specified file does not exist (Sending the [SYSTem:SECurity\[:IMMEDIATE\]](#) command will delete all the files in the memory). You can send the [\\*SAV](#) command to create the measurement configuration file in the specified storage location.
  - A Factory Reset (the [\\*RST](#) command) does not affect the measurement configuration files in the specified storage location. Sending the [SYSTem:SECurity\[:IMMEDIATE\]](#) command will delete all the measurement configuration files in the memory.

**Example** MEM:STAT:DEL 0

**Related Commands** [MEMory:STATe:NAME](#)  
[MEMory:STATe:VALid?](#)

## MEMory:STATe:NAME

**Syntax** MEMory:STATe:NAME <location>[,<name>]

MEMory:STATe:NAME? <location>

**Description** Rename the measurement configuration file in the specified storage location.

**Parameters**

Name	Type	Range	Default
<location>	Discrete	{0 1 2 3 4 5}	None
<name>	Filename	A unquoted string of up to 12 characters, including English letters (a-z, A-Z), numbers (0-9) or the underscore ("_").	If omitted, the default filename is used for the file in the specified storage location.

- Explanation**
- The instrument has six storage locations in the non-volatile memory (refer to [Appendix C: Non-volatile Memory](#)) to store the measurement configuration. You can store the measurement configuration in location 0, 1, 2, 3, 4, or 5 (The corresponding default filenames are 0\_STATE0, 1\_STATE1, 2\_STATE2, 3\_STATE3, 4\_STATE4, 5\_STATE5).
  - This command can only rename the file created by the [\\*SAV](#) command. It can not rename the file created by the [MEMory:SAVE:CONFig](#) command.
  - The instrument generates an error if you specify a name with more than 12 characters.
  - Sending this command will generate an error if the specified file does not exist (Sending the [SYSTem:SECurity\[:IMMEDIATE\]](#) command will delete all the files in the

memory). You can send the [\\*SAV](#) command to create the measurement configuration file in the specified storage location.

- A Factory Reset (the [\\*RST](#) command) does not affect the measurement configuration files in the specified storage location. Sending the [SYSTEM:SECurity\[:IMMediate\]](#) command will delete all the measurement configuration files in the memory.

**Return Format** The query returns the unquoted filename (without the extension). The return format is as follows.

location\_filename

① Specified storage location      ② filename

**Example** MEM:STAT:NAME 1,State11  
MEM:STAT:NAME? 1

The query returns 1\_State11.

**Related Commands** [\\*RCL](#)  
[MEMory:STATe:DELeTe](#)  
[MEMory:STATe:RECall](#)  
[MEMory:STATe:VALid?](#)

## MEMory:STATe:RECall

**Syntax** MEMory:STATe:RECall:AUTO <mode>  
MEMory:STATe:RECall:AUTO?

**Description** Enable or disable the automatic recall of the power-down state at power-on.

Parameters	Name	Type	Range	Default
	<mode>	Bool	{OFF 0 ON 1}	OFF

- Explanation**
- When enabled (ON), the instrument uses the system configuration before the last power-off at power-on.
  - When disabled (OFF), the instrument uses the factory settings (refer to [Appendix A: Factory](#).) at power-on, except the following settings which will not be affected by reset and will always use the configurations before the last power-off.
    - [1] Power Switch
    - [2] Language
    - [3] Module Plug
    - [4] I/O Configuration
  - The instrument disables the automatic recall of the power-down state when the power is turned on after a Factory Reset (send the [\\*RST](#) command).

**Return Format** The query returns 0 (OFF) or 1 (ON).

**Example** MEM:STAT:REC:AUTO ON  
MEM:STAT:REC:AUTO?

The query returns 1.

**Related Command** [SYSTEM:UTIlity:CONFigure:POWEron](#)

## MEMory:STATe:VALid?

**Syntax** MEMory:STATe:VALid? <location>

**Description** Query whether the measurement configuration file in the specified storage location is valid.

**Parameters**

Name	Type	Range	Default
<location>	Discrete	{0 1 2 3 4 5}	None

**Explanation** You can first sending this command to query whether the measurement configuration file in the specified storage location is valid. If yes, send the [\\*RCL](#) command to read the measurement configuration file in the specified storage location into the instrument and overwrites the current measurement configuration.

**Return Format** The query returns 0 (the measurement configuration file in the specified storage location is invalid or not exist) or 1 (the measurement configuration file in the specified storage location is valid).

**Example** MEM:STAT:VAL? 1

The query returns 0.

**Related** [\\*SAV](#)

**Commands** [MEMory:STATe:DELeTe](#)

[MEMory:STATe:NAME](#)

# MMEMemory Command Subsystem

- [MMEMemory:EXPort?](#)
- [MMEMemory:FORMat:READing:CSEParator](#)
- [MMEMemory:FORMat:READing:RLIMit](#)
- [MMEMemory:IMPort:CATalog?](#)
- [MMEMemory:IMPort:CONFig?](#)
- [MMEMemory:LOG\[:ENABLE\]](#)

## MMEMemory:EXPort?

**Syntax** MMEMemory:EXPort?

**Description** Export the readings in the reading memory and the current instrument configuration to the default directory in the external USB storage device.

- Explanation**
- The default directory is \M300\data\<SN>\YYYYMMDD\_hhmmss. Wherein, <SN> is the instrument serial number, YYYYMMDD indicates the current date, and hhmmss indicates the current time.
  - Two csv files are generated in the default directory, namely the instrument configuration (config.csv) and readings (dat00001.csv).

The instrument configuration (config.csv) file contains the M300 model, serial number and software version number, module and its version number in each slot; interface settings as well as scan configuration. The reading (dat00001.csv) file contains the number of scans, scan time and measurement readings of each channel.

- Since this command is time-consuming, reading the return value will generate an error when the timeout time is short. Therefore, we recommend that you adjust the timeout time according to the export time or read the return value after the export operation is finished. The export time is related to the number of readings and the following table shows the relationship.

Number of readings	Export Time
1000	6s
8000	39s
10000	43s
20000	90s
50000	209s
100000	416s

- You can set the field separator in the exported files using the [MMEMemory:FORMat:READing:CSEParator](#) command.

**Return Format** The query returns 0 (no error) or 1 (error is generated) when the file export is complete. If the query returns 1, use the [SYSTem:ERRor?](#) command to read the error information.

**Example** MMEM:EXP?

The query returns 0.

**Related command** [MMEMemory:FORMat:READing:RLIMit](#)

## MMEMory:FORMat:READing:CSEParator

**Syntax** MMEMory:FORMat:READing:CSEParator <column\_separator>  
MMEMory:FORMat:READing:CSEParator?

**Description** Set the filed separator in the exported file.

Parameters	Name	Type	Range	Default
	<column_separator>	Discrete	{TAB COMMa SEMicolon}	COMMa

**Return Format** The query returns TAB (tab), COMM (comma) or SEM (semicolon).

**Example** MMEM:FORM:READ:CSEP SEM  
MMEM:FORM:READ:CSEP?

The query returns SEM.

**Related commands** [SYSTem:ERRor?](#)  
[MMEMory:EXPort?](#)

## MMEMory:FORMat:READing:RLIMit

**Syntax** MMEMory:FORMat:READing:RLIMit <row\_limit>  
MMEMory:FORMat:READing:RLIMit?

**Description** Enable or disable the row limit of the exported file.

Parameters	Name	Type	Range	Default
	<row_limit>	Bool	{OFF 0 ON 1}	ON

- Explanation**
- When the row limit is enabled, the exported file can contain up to 64K ( $2^{16}-1=65535$ ) rows of data. For a large number of scan readings, the exported data are stored in files named dat00001.csv, dat00002.csv, dat00003.csv, and so on, with 65,535 rows of data per file.
  - When the row limit is disabled, the scan data is stored in a single file named dat00001.csv. The storage space is limited by both the space available on the USB storage device and the data format.
  - This setting is saved in the non-volatile memory (refer to [Appendix C: Non-volatile Memory](#)) and will not be affected by the [\\*RST](#) or [SYSTem:PRESet](#) command.

**Return Format** The query returns 0 (OFF) or 1 (ON).

**Example** MMEM:FORM:READ:RLIM ON  
MMEM:FORM:READ:RLIM?

The query returns 1.

**Related command** [MMEMory:EXPort?](#)

## MMEmory:IMPort:CATalog?

**Syntax** MMEmory:IMPort:CATalog?

**Description** Query the blcfg file list in the root directory of the external memory.

- Explanation**
- If the external USB storage device is not inserted or the root directory of the external memory contains no blcfg file, the query returns "".
  - This command only queries the .blcfg files in the the root directory of the external memory.
  - The command only queries the latest blcfg files of the first 50 time stamps in the root directory of the external memory.

**Return Format** This query returns the filenames enclosed in double quotation marks. Multiple return values are separated by commas.

**Example** MMEM:IMP:CAT?

The query returns "MyConfigure1.blcfg","MyConfigure2.blcfg".

**Related command** [MMEmory Command Subsystem](#)

## MMEmory:IMPort:CONFig?

**Syntax** MMEmory:IMPort:CONFig? "<configuration\_file>"

**Description** Import a .blcfg file and configure the instrument according to the contents of the .blcfg file. The query returns 0 when the file is successfully imported and returns 1 when error occurs.

Parameters	Name	Type	Range	Default
	<configuration_file>	Filename	Filename with the .blcfg extension and with up to 40 characters.	None

- Explanation**
- This command can only import the .blcfg file in the the root directory of the external memory.
  - This command only import the latest .blcfg files of the first 50 time stamps in the root directory of the external memory. The filename cannot exceed 40 characters.
  - The import operation requires several seconds during which bit14 in the operation status register is set to 1 until the import operation is finished and the import result is returned. During this process, other I/O commands cannot be sent.

**Return Format** The query returns 0 (the file is successfully imported) or 1 (error occurs).

**Example** MMEM:IMP:CONF? "MyConfigure1.blcfg"

The query returns 0.

**Related commands** [SYSTem:ERRor?](#)  
[MMEmory Command Subsystem](#)



## MMEMory:LOG[:ENABle]

**Syntax** MMEMory:LOG[:ENABle] <state>

MMEMory:LOG[:ENABle]?

**Description** Enable or disable the function to output the scan data to the USB storage device in real-time.

Parameters	Name	Type	Range	Default
	<state>	Bool	{OFF 0 ON 1}	OFF

- Explanation**
- This setting is saved in the non-volatile memory (refer to [Appendix C: Non-volatile Memory](#)) and will not be affected by the [\\*RST](#) or [SYSTem:PRESet](#) command.
  - For the [READ?](#) and [MEASure?](#) command, extra time is required to output the scan data to the USB storage device in real-time.
  - If you remove the USB storage device during logging, logging will stop but the scan will continue. If you re-attach the USB storage device, it will not cause logging to resume unless you follow the procedure shown below.
    - [1] Press the Run/Stop button for several seconds until the scan stops.
    - [2] Once the instrument is idle, insert the USB storage device.
    - [3] Press the Run/Stop button again to restart scanning.

**Return Format** The query returns 0 (OFF) or 1 (ON).

**Example** MMEM:LOG ON  
MMEM:LOG?

The query returns 1.

**Related command** [MMEMory Command Subsystem](#)

## OUTPut Command Subsystem

- [OUTPut:ALARm<n>:CLEAr](#)
- [OUTPut:ALARm:CLEAr:ALL](#)
- [OUTPut:ALARm<n>:ENABle?](#)
- [OUTPut:ALARm\[<n>\]:MODE](#)
- [OUTPut:ALARm\[<n>\]:SLOPe](#)
- [OUTPut:ALARm<n>:SOURce](#)

### OUTPut:ALARm<n>:CLEAr OUTPut:ALARm:CLEAr:ALL

**Syntax** OUTPut:ALARm<n>:CLEAr  
OUTPut:ALARm:CLEAr:ALL

**Description** Clear the alarm output line(s) of the specified channel or all the channels.

Parameters	Name	Type	Range	Default
	<n>	Discrete	1 2 3 4	None

- Explanation**
- You can clear the alarm output lines at any time (even during a scan) and the alarm data in memory will not be cleared. The alarm output lines and alarm data are cleared when you initiate a new scan.
  - A Factory Reset (the [\\*RST](#) command) clears the alarm output lines of all the alarm channels but does not clear the alarm queue.

**Example** OUTP:ALAR1:CLE  
OUTP:ALAR:CLE:ALL

### OUTPut:ALARm<n>:ENABle?

**Syntax** OUTPut:ALARm<n>:ENABle?

**Description** Query the channels that were assigned to alarm channel n and of which the alarm functions are enabled. When channels are assigned to alarm channel n, it should report all the alarms on the channels.

Parameters	Name	Type	Range	Default
	<n>	Discrete	1 2 3 4	None

**Explanation** A Factory Reset (the [\\*RST](#) command) clears the alarm output lines of all the alarm channels but does not clear the alarm queue.

**Return Format** The query returns the channels that were assigned to alarm channel n and of which the alarm functions are enabled. The return format is as follows.

#210(@301,302)

① followed by 2 characters    ② followed by 10 characters    ③ channel numbers

**Example** OUTP:ALAR1:ENAB?  
The query returns #210(@301,302).

**Related command** [OUTPut:ALARm<n>:SOURce](#)

## OUTPut:ALARm[<n>]:MODE

**Syntax** OUTPut:ALARm[<n>]:MODE <mode>

OUTPut:ALARm[<n>]:MODE?

**Description** Set the output mode of the alarm output line of the specified channel.

**Parameters**

Name	Type	Range	Default
<n>	Discrete	1 2 3 4	None <sup>[1]</sup>
<mode>	Discrete	{LATCh TRACk}	LATCh

**Note**<sup>[1]</sup>: When you omit this parameter, this command sets the output mode of all the alarm output lines.

**Explanation** ➤ When an alarm is generated, the corresponding pin of the Alarm/Ext Trig interface (converted from the **[RS-232/Alarms/Ext Trig]** interface) at the rear panel outputs a pulse with the specified edge.

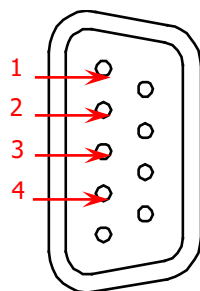

Alarm/Ext Trig Interface

Pin	Definition
1	Alarm 1 Output
2	Alarm 2 Output
3	Alarm 3 Output
4	Alarm 4 Output

- **LATCh:** in this mode, the corresponding pin is latched to the status (high level or low level) specified by the [OUTPut:ALARm\[<n>\]:SLOPe](#) command when the first alarm occurs and remains asserted until you clear it by initiating a new scan or cycling power. You can clear the alarm status of the corresponding pin (send the [OUTPut:ALARm<n>:CLEAr](#) command) at any time (even during a scan) and the alarm data is not cleared (however, the data is cleared when you initiate a new scan).
- **TRACk:** in this mode, the corresponding pin jumps to the status (high level or low level) specified by the [OUTPut:ALARm\[<n>\]:SLOPe](#) command when a reading of the channel crosses a limit and remains outside the limit. When a reading returns to within limits, the alarm status of this pin is automatically cleared. You can clear the alarm status of the pin (send the [OUTPut:ALARm<n>:CLEAr](#) command) at any time (even during a scan) and the alarm data is not cleared. The output pin and alarm data are both cleared when you initiate a new scan.
- A Factory Reset (the [\\*RST](#) command) selects the Latch mode as the output mode of the alarm output line.

**Return Format** The query returns LATC or TRAC.

**Example** OUTP:ALAR2:MODE TRAC  
OUTP:ALAR2:MODE?

The query returns TRAC.

**Related command** [OUTPut:ALARm:CLEAr:ALL](#)

## OUTPut:ALARm[<n>]:SLOPe

**Syntax** OUTPut:ALARm[<n>]:SLOPe <edge>

OUTPut:ALARm[<n>]:SLOPe?

**Description** Set the edge type of the alarm output of the specified alarm channel.

### Parameters

Name	Type	Range	Default
<n>	Discrete	1 2 3 4	None <sup>[1]</sup>
<edge>	Discrete	{NEGative POSitive}	NEGative

**Note<sup>[1]</sup>:** When you omit this parameter, this command sets the edge types of all the alarm output lines.

**Explanation** ➤ When an alarm is generated, the corresponding pin of the Alarm/Ext Trig interface (converted from the **[RS-232/Alarms/Ext Trig]** interface) at the rear panel outputs a pulse with the specified edge.

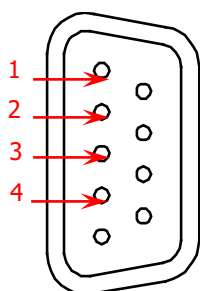

Alarm/Ext Trig Interface

Pin	Definition
1	Alarm 1 Output
2	Alarm 2 Output
3	Alarm 3 Output
4	Alarm 4 Output

- NEGative: the corresponding pin outputs TTL low level (0 V) when an alarm is generated
- POSitive: the corresponding pin outputs TTL high level (+3.3 V) when an alarm is generated
- A Factory Reset (the **\*RST** command) sets the edge type of the alarm output of the alarm channel to low level.

**Return Format** The query returns NEG or POS.

**Example** OUTP:ALAR3:SLOP NEG  
OUTP:ALAR3:SLOP?

The query returns NEG.

**Related commands** [OUTPut:ALARm<n>:CLEAr](#)  
[OUTPut:ALARm:CLEAr:ALL](#)

## OUTPut:ALARm<n>:SOURce

**Syntax** OUTPut:ALARm<n>:SOURce (@<ch\_list>)

OUTPut:ALARm<n>:SOURce?

**Description** Specify the alarm channel used to report the alarm situations on the specified multiplexer, DIO or TOT channels.

Parameters	Name	Type	Range	Default
	<n>	Discrete	1 2 3 4	None
	<ch_list>	Channel List	One or more channels (for the multiplexer, DIO or TOT channels), the rules are as follows: (@101): channel 01 on the module in Slot1; (@101:103): channel 01 through 03 on the module in Slot1; (@101:103,301): channel 01 through 03 on the module in Slot1 and channel 01 on the module in Slot3.	None

- Explanation**
- You can specify any of the four alarm channels as the alarm channel of the multiplexer, DIO and TOT channels. For example, you can specify alarm1 as the alarm channel for 103, 205 and 310 channels; alarm1 will generated an alarm when any reading of these channels meets the specified alarm condition. You cannot specify multiple alarm channels for a channel.
  - A Factory Reset (the [\\*RST](#) command) specifies ALARm1 to report the alarm situations of all the multiplexer, DIO and TOT channels.
  - A Factory Reset (the [\\*RST](#) command) clears all the alarm limits and turns off the alarms. An Instrument Preset (the [SYSTem:PRESet](#) command) or Card Reset (the [SYSTem:CPON](#) command) does not clear the alarm limits and does not turn off the alarms.

**Return Format** The query returns the channels assigned to alarm channel n. The return format is as follows.

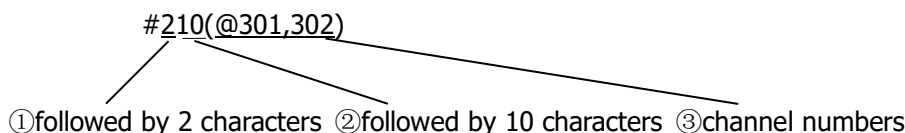

**Example** OUTP:ALAR1:SOUR (@313,316)  
 OUTP:ALAR1:SOUR?

The query returns #210(@313,316).

- Related commands**
- [OUTPut Command Subsystem](#)
  - [CALCulate:LIMit:LOWer](#)
  - [CALCulate:LIMit:UPPer](#)
  - [CALCulate:COMPare:DATA](#)
  - [CALCulate:COMPare:MASK](#)
  - [CALCulate:COMPare:STATE](#)
  - [CALCulate:LIMit:LOWer:STATE](#)
  - [CALCulate:LIMit:UPPer:STATE](#)

## R?

**Syntax** R? [<max\_count>]

**Description** Read and erase the readings in the volatile memory (refer to [Appendix D: Volatile Memory](#)). The instrument starts reading from the oldest reading and up to <max\_count> number of readings can be read and erased. This command can be used to clear the reading memory periodically to avoid data overflow (for example, during a scan with an infinite scan count).

Parameters	Name	Type	Range	Default
	<max_count>	Integer	Maximum number of readings to be read and erased from memory, from 1 to 10,0000.	If you omit <max_count>, this command reads all the readings in the volatile memory.

- Explanation**
- This command is a special version of the [DATA:REMOve?](#) command and provides faster execution speed. You can read the readings in the memory at any time (even during a scan) using this command.
  - For scan measurements using the multiplexer module, an error is generated if the DMM module is disabled (refer to the [INSTrument:DMM](#) command) or not installed in the mainframe. The DMM module is not required for operations on the multifunction module.
  - Each reading returned may or may not contain the measurement units, time stamp, channel number and alarm status information, depending on the settings of the [FORMat Command Subsystem](#) commands.
  - The instrument clears all the readings in the reading memory after a Factory Reset (the [\\*RST](#) command), after an Instrument Preset (the [SYSTem:PRESet](#) command) or when mainframe power is cycled (the power-on value is set to "Default", refer to the [SYSTem:UTILity:CONFigure:POWEron](#) command).

**Return Format** The return value starts with #. For example, #251+3.200441253E-03,+3.259494057E-03,+3.221523656E-03. The number "2" following # denotes that the data length information 51 occupies 2 characters; the number "51" denotes that there are 51-byte readings; "+3.200441253E-03,+3.259494057E-03,+3.221523656E-03" are the 51-byte readings (three readings).

Format explanation:

#251+1.366095803E-01,-4.475357308E-04,-3.702042950E-04

① followed by 2 characters    ② followed by 51 bytes    ③ 3 readings(51 bytes)

**Example** R? 1

The query returns #216+3.200441253E-03.

## READ?

**Syntax** READ?

**Description** Change the trigger status of the instrument from the "idle" state to the "wait-for-trigger" state. The instrument starts scanning when the specified trigger conditions are satisfied. Readings are sent to the reading memory and output buffer during the scan.

This command have to be used with the following modules.

- ✧ MC3120: 20-Channel Multiplexer
- ✧ MC3132: 32-Channel Multiplexer
- ✧ MC3164: 64-Channel Single-Ended Multiplexer
- ✧ MC3324: 20-Voltage Channel+4-Current Channel Multiplexer
- ✧ MC3534: Multifunction Module

- Explanation**
- Sending the READ? command is similar to sending the [INITiate](#) command followed immediately by the [FETCh?](#) command.
  - For scan measurements using the multiplexer modules, an error is generated if the DMM module is disabled (refer to the [INSTrument:DMM](#) command) or not installed in the mainframe. The DMM module is not required for operations on the multifunction module.
  - Each reading returned may or may not contain the measurement units, time stamp, channel number and alarm status information, depending on the settings of the [FORMat Command Subsystem](#) commands.
  - The READ? query is not valid with the [\\*TRG](#) command.
  - The instrument clears all the readings in the reading memory after a Factory Reset (the [\\*RST](#) command), after an Instrument Preset (the [SYSTem:PRESet](#) command), or when mainframe power is cycled (the power-on value is set to "Default", refer to the [SYSTem:UTIlity:CONFigure:POWEron](#) command)).

**Return Format** The query returns the measurement readings (the format is set by the [FORMat Command Subsystem](#) commands) in scientific notation. Multiple return values are separated by commas.

**Example** CONF:VOLT:DC 20,DEF,(@401:403)  
ROUT:SCAN (@401:403)  
TRIG:SOUR IMM  
READ?

The query returns +3.061584378E-03,+3.338635854E-03,+3.335876377E-03.

**Related command** [ROUTe:SCAN](#)

## ROUTE Command Subsystem

- [ROUTE:CHANnel:ADVance:SOURce](#)
- [ROUTE:CHANnel:ADVance:EDGE](#)
- [ROUTE:CHANnel:DELay](#)
- [ROUTE:CHANnel:DELay:AUTO](#)
- [ROUTE:CHANnel:FWIRe](#)
- [ROUTE:CLOSe](#)
- [ROUTE:CLOSe:EXCLusive](#)
- [ROUTE:DONE?](#)
- [ROUTE:MONitor\[:CHAN\]](#)
- [ROUTE:MONitor:DATA?](#)
- [ROUTE:MONitor:DATA:FULL?](#)
- [ROUTE:MONitor:STATe](#)
- [ROUTE:OPEN](#)
- [ROUTE:SCAN](#)
- [ROUTE:SCAN:SIZE?](#)

### ROUTE:CHANnel:ADVance:SOURce

**Syntax** ROUTe:CHANnel:ADVance:SOURce <source>  
 ROUTe:CHANnel:ADVance:SOURce?

**Description** Select the advanced source mode. This setting is only applicable when the external digital multimeter is used. The advanced source provides advanced channel signals. The instrument opens the current channel and close the next channel in the scan list when the advanced channel signal is received.

Parameters	Name	Type	Range	Default
	<source>	Discrete	{EXTernal BUS IMMediate}	EXTernal

**Explanation**

- This command is valid only when the DMM module is disabled (refer to the [INSTrument:DMM](#) command) or is not installed.
- **EXTernal**: receive the external advanced channel signal input from the pin 6 of the Alarms/Ext Trig interface (convert from the **[RS-232/Alarms/Ext Trig]** Interface).  
 As the "EXTernal" advanced source input and the external trigger input use the same pin, the external trigger mode does not support "EXTernal" advanced source.

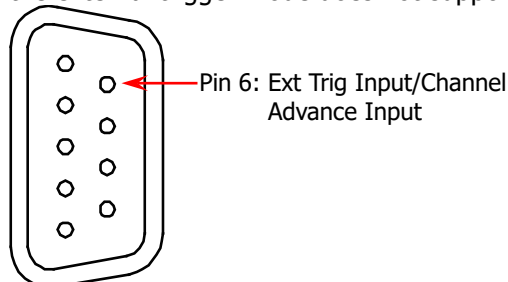

Alarms/Ext Trig Interface

- **BUS** (Single): the instrument switches to the next channel when the [\\*TRG](#) command



is send via the remote interface. The [\\*TRG](#) command is only valid when M300 is in the "wait-for-trigger" state (refer to the [INITiate](#) command).

The BUS trigger mode dose not support "BUS (Single)" advanced source.

- **IMMediate:** the instrument opens the current channel and closes the next channel after finishing measuring the current channel.
- DIO and TOT channels do not support the advanced source setting. Measurements on these channels can be performed by M300 alone and the signal synchronization with the external multimeter is not required.
- The instrument selects external advanced souce after a Factory Reset (the [\\*RST](#) command) or when mainframe power is cycled (on the power-on value is set to "Default", refer to the [SYSTem:UTIlity:CONFigure:POWEron](#) command). The current settings will be not be affected after an Instrument Preset (the [SYSTem:PRESet](#) command).

**Return Format** The query returns the current advanced source mode (EXT, BUS or IMM).

**Example** INST:DMM OFF  
 ROUT:SCAN (@202:220)  
 TRIG:SOUR IMM  
 TRIG:COUN 3  
 ROUT:CHAN:ADV:SOUR EXT  
 ROUT:CHAN:ADV:SOUR?

The query returns EXT.

**Related commands** [ROUTE Command Subsystem](#)  
[INSTrument:DMM](#)  
[TRIGger Command Subsystem](#)

## ROUTE:CHANnel:ADVance:EDGE

**Syntax** ROUTe:CHANnel:ADVance:EDGE {RISing|FALLing}

ROUTe:CHANnel:ADVance:EDGE?

**Description** Set the instrument to open the current channel and close the next channel in the scan list on the rising edge or falling edge of the input signal when the advanced source is set to external (EXTernal). This command is only available when external digital multimeter is used.

Parameters	Name	Type	Range	Default
	{RISing FALLing}	Discrete	RISing FALLing	None

- Explanation**
- This command is valid only when the DMM module is disabled (refer to the [INSTrument:DMM](#) command) or is not installed and it is also used to set the edge type in the external trigger mode.
  - **EXTernal:** receive the external advanced channel signal input from the pin 6 of the Alarms/Ext Trig interface (convert from the **[RS-232/Alarms/Ext Trig]** Interface). The instrument opens the current channel and closes the next channel in the scan list on the specified type od edge of the input signal.

As the "EXTernal" advanced source input and the external trigger input use the same pin, the external trigger mode does not support "EXTernal" advanced source.

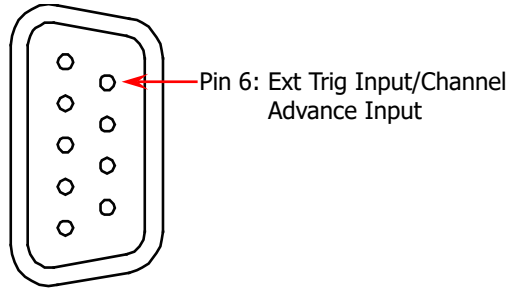

Alarms/Ext Trig Interface

**Return Format** The query returns the edge type currently specified (FALL (falling edge) or RIS (rising edge)).

**Example**

```

INST:DMM OFF
ROUT:SCAN (@202:220)
TRIG:SOUR IMM
TRIG:COUN 3
ROUT:CHAN:ADV:SOUR EXT
ROUT:CHAN:ADV:EDGE FALL
ROUT:CHAN:ADV:EDGE?

```

The query returns FALL.

**Related command** [ROUTe:CHANnel:ADVance:SOURce](#)

### ROUTe:CHANnel:DELay

**Syntax** ROUTe:CHANnel:DELay <seconds>,(@<ch\_list>)  
 ROUTe:CHANnel:DELay? (@<ch\_list>)

**Description** Set the delay between the multiplexer channels in the scan list.

Parameters	Name	Type	Range	Default
	<seconds>	Numeric	A number from 0 to 60, with 1 ms resolution.	None
	<ch_list>	Channel List	One or more channels (only for the multiplexer channels), the rules are as follows: (@101): channel 01 on the module in Slot1; (@101:103): channel 01 through 03 on the module in Slot1; (@101:103,301,406:408): channel 01 through 03 on the module in Slot1, channel 01 on the module in Slot3 and channel 06 through 08 on the module in Slot4.	If the parameter is omitted, this command will be applied to the whole scan list.

**Explanation** ➤ Channel delay is the time interval between two neighboring channels during a scan as shown in the figure below. During the scan, the instrument immediately disconnects the previous channel and closes the current channel after finishing measuring the previous channel; and then, starts measuring the current channel after the specified channel delay.

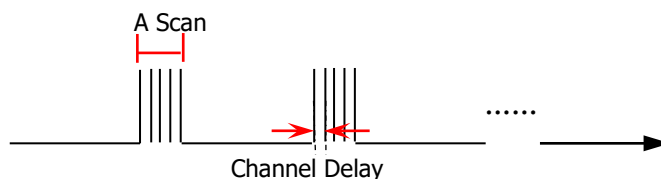

- You can select a unique delay for each channel on the module. The default channel delay is automatic; the instrument determines the delay based on the measurement function, range, integration time and AC filter setting.
- The channel delay is only valid during a scan.
- The [CONFigure Command Subsystem](#) and [MEASure Command Subsystem](#) commands set the channel delay to automatic.
- The instrument sets the channel delay to automatic after a Factory Reset (the [\\*RST](#) command). An Instrument Preset (the [SYSTem:PRESet](#) command) or Card Reset (the [SYSTem:CPON](#) command) does not affect the current channel delay setting.

**Return Format** The query returns the delays of the specified channels in scientific notation. Multiple return values are separated by commas.

**Example** ROUT:CHAN:DEL 5,(@213,215)  
 ROUT:CHAN:DEL? (@213,215)  
 Tquery returns +5.00000000E+00,+5.00000000E+00.

**Related commands** [ROUTE Command Subsystem](#)  
[ROUTE:CHANnel:DELay:AUTO](#)

## ROUTE:CHANnel:DELay:AUTO

**Syntax** ROUTe:CHANnel:DELay:AUTO <state>[,(@<ch\_list>)]  
 ROUTe:CHANnel:DELay:AUTO? [(@<ch\_list>)]

**Description** Enable or disable the automatic delay of the specified multiplexer channels.

**Parameters**

Name	Type	Range	Default
<state>	Bool	{OFF 0 ON 1}	1
<ch_list>	Channel List	One or more channels (only for the multiplexer channels), the rules are as follows: (@101): channel 01 on the module in Slot1; (@101:103): channel 01 through 03 on the module in Slot1; (@101:103,301,406:408): channel 01 through 03 on the module in Slot1, channel 01 on the module in Slot3 and channel 06 through 08 on the module in Slot4.	If the parameter is omitted, this command will be applied to the whole scan list.

- Explanation**
- When automatic delay is enabled, the instrument determines the delay based on the measurement function, range, integration time and AC filter setting.
  - Selecting a specific channel delay using the [ROUTE:CHANnel:DELay](#) command disables the automatic channel delay.
  - The [CONFigure Command Subsystem](#) and [MEASure Command Subsystem](#) commands set the channel delay to automatic.
  - The instrument sets the channel delay to automatic after a Factory Reset (the [\\*RST](#) command). An Instrument Preset (the [SYSTem:PRESet](#) command) or Card Reset (the [SYSTem:CPON](#) command) does not affect the current channel delay setting.

**Return Format** The query returns 0 (OFF) or 1 (ON). Multiple return values are separated by commas.

**Example** ROUT:CHAN:DEL:AUTO ON,(@101:103)

ROUT:CHAN:DEL:AUTO? (@101:103)

The query returns 1,1,1.

**Related command** [ROUTe Command Subsystem](#)

## ROUTe:CHANnel:FWIRe

**Syntax** ROUTe:CHANnel:FWIRe <state>[,(@<ch\_list>)]

ROUTe:CHANnel:FWIRe? [(@<ch\_list>)]

**Description** Enable or disable the 4-wire scan of the specified channels. This setting is only available when the external digital multimeter is used.

### Parameters

Name	Type	Range	Default
<state>	Bool	{OFF 0 ON 1}	None
<ch_list>	Channel List	One or more channels (only for the multiplexer channels), the rules are as follows: (@101): channel 01 on the module in Slot1; (@101:103): channel 01 through 03 on the module in Slot1; (@101:103,301,406:408): channel 01 through 03 on the module in Slot1, channel 01 on the module in Slot3 and channel 06 through 08 on the module in Slot4.	If the parameter is omitted, this command will be applied to the whole scan list.

- Explanation**
- When enabled, channel n is paired with channel n+16 (for MC3132, the range of n is from 1 to 16) or n+10 (for MC3324 and MC3120, the range of n is from 1 to 10) automatically. Channel n is used to connect the source terminal of the DMM module and channel n+16 or channel n+10 is used to connect the sense terminal of the DMM module. Other related configurations are not allowed for the paired channels of the 4-wire mode.
  - The MC3164 modules do not support the 4-wire scan.
  - This command is valid only when the DMM module is disabled (refer to the [INSTrument:DMM](#) command) or is not installed.
  - The [ROUTe:CLOSe](#), [ROUTe:CLOSe:EXCLusive](#), and [ROUTe:OPEN](#) commands ignore the current [ROUTe:CHANnel:FWIRe](#) setting (when no channel is in the scan list).

**Return Format** The query returns 0 (OFF) or 1 (ON). Multiple return values are separated by commas.

**Example**  
 INST:DMM OFF  
 ROUT:CHAN:FWIR ON,(@201:203)  
 ROUT:CHAN:FWIR? (@201:203)

The query returns 1,1,1.

**Related commands** [ROUTe Command Subsystem](#)  
[ROUTe:CHANnel:ADVance:SOURce](#)

## ROUTE:CLOSE

**Syntax** ROUTE:CLOSE (@<ch\_list>)

ROUTE:CLOSE? (@<ch\_list>)

**Description** Close the specified channels on a multiplexer, actuator, matrix switch module or RF multiplexer.

Parameters	Name	Type	Range	Default
	<ch_list>	Channel List	One or more channels on a multiplexer, actuator, matrix switch module or RF multiplexer, the rules are as follows:  (@101): channel 01 on the module in Slot1; (@101:103): channel 01 through 03 on the module in Slot1; (@101:103,301,406:408): channel 01 through 03 on the module in Slot1, channel 01 on the module in Slot3 and channel 06 through 08 on the module in Slot4.	None

- Explanation**
- For the multiplexer modules, if any channel on the module is defined to be part of the scan list, attempting to send this command will result in an error.
  - When the scan is initiated, the instrument will open all the multiplexer channels (some multiplexer channels are added into the scan list).
  - Sending this command will affect the relay cycle count (refer to [DIAGnostic:RELAy:CYCLes?](#) command).
  - For the matrix module, the channel number represents row number and column number. For example, channel 126 represents the second row and six column on the module in Slot1. For more information, refer to the User's Guide.
  - For the RF multiplexer, the channel number can only be from *s11* to *s14* and from *s21* to *s24*. *s* represents the number of the slot. *s11* to *s14* (*s21* to *s24*) represents the four channels of the first (second) bank of RF multiplexer and only one channel can be closed at a time.
  - For the RF multiplexer, the [ROUTE:OPEN](#) command is invalid. To open a channel, you can send this command to close one of the other channels in the same bank.
  - For the actuator module, the specified channels connect to the NO side after sending this command.
  - The instrument opens all the channels of the multiplexer, actuator and matrix switch after a Factory Reset (the [\\*RST](#) command). An Instrument Preset (the [SYSTEM:PRESet](#) command) does not affect the state of the channel relay.

**Return Format** The query returns 0 (open) or 1 (closed). Multiple return values are separated by commas.

**Example** ROUT:CLOS (@201:203)  
ROUTE:CLOS? (@201:203)

The query returns 1,1,1.

**Related commands** [ROUTE Command Subsystem](#)  
[ROUTE:CLOSE:EXCLUSIVE](#)  
[ROUTE:OPEN](#)

## ROUTe:CLOSe:EXCLusive

**Syntax** ROUTe:CLOSe:EXCLusive (@<ch\_list>)

**Description** Close the specified channels after opening all the channels on a multiplexer, actuator, matrix switch or RF multiplexer.

**Parameters**

Name	Type	Range	Default
<ch_list>	Channel List	One or more channels on a multiplexer, actuator, matrix switch or RF multiplexer, the rules are as follows: (@101): channel 01 on the module in Slot1; (@101:103): channel 01 through 03 on the module in Slot1; (@101:103,301,406:408): channel 01 through 03 on the module in Slot1, channel 01 on the module in Slot3 and channel 06 through 08 on the module in Slot4.	None

- Explanation**
- For the multiplexer modules, if any channel on the module is defined to be part of the scan list, attempting to send this command will result in an error.
  - Sending this command will affect the relay cycle count (refer to the [DIAGnostic:RELAy:CYCLes?](#) command).
  - For the matrix module, the channel number represents row number and column number. For example, channel 126 represents the second row and six column on the module in Slot1. For more information, refer to the User's Guide.
  - For the RF multiplexer, the channel number can only be from *s11* to *s14* and from *s21* to *s24*. *s* represents the number of the slot. *s11* to *s14* (*s21* to *s24*) represents the four channels of the first (second) bank of RF multiplexer and only one channel can be closed at a time.
  - This command opens all the channels of the module, and then closes the channels specified in <ch\_list>.
  - The instrument opens all the channels of the multiplexer, actuator and matrix switch after a Factory Reset (the [\\*RST](#) command). An Instrument Preset (the [SYSTEM:PRESet](#) command) does not affect the state of the channel relay.

**Example** ROUT:CLOS:EXCL (@303)

**Related commands** [ROUTe Command Subsystem](#)  
[ROUTe:CLOSe](#)  
[ROUTe:OPEN](#)

## ROUTe:DONE?

**Syntax** ROUTe:DONE?

**Description** Query the operation status of the relay (namely, whether the operation is finished).

- Explanation**
- This command is usually used with the relay control command [ROUTe:CLOSe](#), [ROUTe:CLOSe:EXCLusive](#) or [ROUTe:OPEN](#) to query whether the operation of the relay specified by the relay control command is finished.
  - It returns 1 when all the relay operations specified by the relay operation command before this command are finished; otherwise, it returns 0.
  - This command can be used even during a scan.

**Return Format** The query returns 1 or 0.

**Example** ROUT:CLOS (@201:203)

ROUT:DONE?

The query returns 1.

**Related command** [ROUTe Command Subsystem](#)

## ROUTE:MONitor[:CHAN]

**Syntax** ROUTe:MONitor[:CHAN] (@<ch\_list>)

ROUTe:MONitor[:CHAN]?

**Description** Add the specified channels into the monitor list.

**Parameters**

Name	Type	Range	Default
<ch_list>	Channel List	One or more channels (for the multiplexer, DIO or TOT channels), the rules are as follows: (@101): channel 01 on the module in Slot1; (@101:103): channel 01 through 03 on the module in Slot1; (@101:103,301,406:408): channel 01 through 03 on the module in Slot1, channel 01 on the module in Slot3 and channel 06 through 08 on the module in Slot4;	None

- Explanation**
- In the monitor mode, the instrument performs continuous measurements on the specified channels and displays the measurement values on the front panel display. At most 7 channels can be monitored at the same time and you can change the channels monitored at any time.
  - The channel monitor function can monitor the following channels: the multiplexer channels (configured to the scan list and the DMM module is enabled), DIO and TOT channels of the multifunction module (no matter whether they are configured to the scan list and the DMM module is not required). Sending the command will generate an error when the above conditions are not satisfied.
  - A scan (refer to [ROUTE:SCAN](#)) always has priority over the monitor function.
  - When the alarm function and scaling function are applied to the channel being monitored, all the alarm data is stored in the alarm queue (which will be cleared at power-off).
  - For 4-wire resistance measurements, the instrument automatically pairs channel n with channel n+16 (for MC3132, the range of n is from 1 to 16) or n+10 (for MC3324, MC3120 and MC3120A, the range of n is from 1 to 10). Channel n is used to connect the source terminal of the DMM module and channel n+16 or channel n+10 is used to connected the sense terminal of the DMM module.
  - Readings acquired during a monitor are not stored in the memory but they are displayed on the screen.

**Return Format** The query returns the numbers of the channels in the monitor list. The format is as follows.  
 Format explanation:

#210(@301,302)

① followed by 2 characters    ② followed by 10 characters    ③ channel numbers

**Example** CONF:VOLT:DC (@103:105)  
 ROUT:MON:CHAN (@103:105)  
 ROUT:MON:STAT ON  
 ROUT:MON:CHAN?

The query returns #214(@103,104,105).

**Related commands** [ROUTe Command Subsystem](#)  
[ROUTe:MONitor:STATe](#)

## ROUTe:MONitor:DATA?

**Syntax** ROUTe:MONitor:DATA?

**Description** Query the measurement values of all the monitored channels.

**Explanation**

- It returns the reading only; the units, time stamp, channel number and alarm status information are not returned (not affected by the [FORMat Command Subsystem](#) commands).
- If the monitor mode is disabled, an error indicating that it is unable to perform the requested operation will be generated when sending this command.
- Readings acquired during a monitor are not stored in the memory but they are displayed on the front panel screen; however, all the readings from a scan in progress are stored in the memory.

**Return Format** The query returns the readings of all the monitored channels in scientific notation. Multiple return values are separated by commas.

**Example** ROUT:MON:DATA?  
 The query returns -6.514059579E-04,-1.011260443E-03.

**Related commands** [ROUTe Command Subsystem](#)  
[ROUTe:MONitor\[:CHAN\]](#)  
[ROUTe:MONitor:STATe](#)

## ROUTe:MONitor:DATA:FULL?

**Syntax** ROUTe:MONitor:DATA?

**Description** Query the scan readings of all the monitored channels (the readings are returned in full format).

**Explanation**

- It returns the reading with the units, time stamp, channel number and alarm status information (not affected by the [FORMat Command Subsystem](#) commands).
- If the monitor mode is disabled, an error indicating that it is unable to perform the requested operation will be generated when sending this command.
- Readings acquired during a monitor are not stored in the memory but they are displayed on the front panel screen; however, all the readings from a scan in progress are stored in the memory.

**Return Format** The query returns the readings of all the monitored channels in scientific notation. Multiple return values are separated by commas.



**Example** ROUT:MON:DATA:FULL?

The query returns -1.538041765E-03V,2013,10,31,08,57,32.339,301,0.

**Related commands** [ROUTe Command Subsystem](#)  
[ROUTE:MONitor\[:CHAN\]](#)

[ROUTE:MONitor:STATE](#)

## ROUTE:MONitor:STATE

**Syntax** ROUTe:MONitor:STATE <mode>

ROUTE:MONitor:STATE?

**Description** Enable or disable the monitor function.

**Parameters**

Name	Type	Range	Default
<mode>	Bool	{OFF 0 ON 1}	OFF

**Explanation**

- In the monitor mode, the instrument performs continuous measurements on the specified channels and displays the measurement values on the front panel display. At most 7 channels can be monitored at the same time and you can change the channels monitored at any time.
- If no scan list is currently configured, the first channel of the multifunction module (DIO channel) is monitored.
- The channel monitor function can monitor the following channels: the multiplexer channels (configured to the scan list and the DMM module is enabled), the DIO and TOT channels of the multifunction module (no matter whether they are configured to the scan list and the DMM module is not required). Sending the command will generate an error when the above conditions are not satisfied.
- A scan (refer to the [ROUTE:SCAN](#) command) always has priority over the monitor function.
- When the alarm function and scaling function are applied to the channel being monitored, all the alarm data is stored in the alarm queue (which will be cleared at power-off).
- Readings acquired during a monitor are not stored in the memory but they are displayed on the front panel screen, however, all the readings from a scan in progress are stored in the memory.

**Return Format** The query returns 0 (OFF) or 1 (ON).

**Example** CONF:VOLT:DC (@103:105)  
ROUT:MON:CHAN (@103:105)  
ROUT:MON:STAT ON  
ROUT:MON:STAT?

The query returns 1.

**Related commands** [ROUTe Command Subsystem](#)  
[ROUTE:MONitor\[:CHAN\]](#)

[ROUTE:MONitor:DATA?](#)

## ROUTe:OPEN

**Syntax** ROUTe:OPEN (@<ch\_list>)

ROUTe:OPEN? (@<ch\_list>)

**Description** Open the specified channels on a multiplexer, actuator or matrix switch.

**Parameters**

Name	Type	Range	Default
<ch_list>	Channel List	One or more channels (for the multiplexer, actuator and matrix switch channels), the rules are as follows:  (@101): channel 01 on the module in Slot1; (@101:103): channel 01 through 03 on the module in Slot1; (@101:103,301,406:408): channel 01 through 03 on the module in Slot1, channel 01 on the module in Slot3 and channel 06 through 08 on the module in Slot4;	None

**Explanation**

- For the multiplexer modules, if any channel on the module is defined to be part of the scan list, attempting to send this command will result in an error.
- When the scan is initiated, the instrument will open all the multiplexer channels (some multiplexer channels are added into the scan list).
- Sending this command will affect the relay cycle count (refer to the [DIAGnostic:RELAy:CYCLes?](#) command).
- For the matrix module, the channel number represents row number and column number. For example, channel 126 represents the second row and six column on the module in Slot1. For more information, refer to the User's Guide.
- For the actuator module, the specified channels connect to the NC side after sending this command.
- For the RF multiplexer, this command is invalid. To open a channel, you can send the [ROUTe:CLOSe](#) command to close one of the other channels in the same bank.
- The instrument opens all the channels of the multiplexer, actuator and matrix switch after a Factory Reset (the [\\*RST](#) command). An Instrument Preset (the [SYSTem:PRESet](#) command) does not affect the state of the channel relay.

**Return Format**

The query returns 0 (closed) or 1 (open). Multiple return values are separated by commas.

**Example**

ROUT:OPEN (@201:203)

ROUT:OPEN? (@201:203)

The query returns 1,1,1.

**Related commands**

[ROUTe Command Subsystem](#)

[ROUTe:CLOSe](#)

[ROUTe:CLOSe:EXCLusive](#)

## ROUTE:SCAN

**Syntax** ROUTE:SCAN (@<scan\_list>)

ROUTE:SCAN?

**Description** Add the specified channels into the scan list.

**Parameters**

Name	Type	Range	Default
<scan_list>	Scan List	One or more channels (for the multiplexer, DIO and TOT channels), the rules are as follows: (@101): channel 01 on the module in Slot1; (@101:103): channel 01 through 03 on the module in Slot1; (@101:103,301,406:408): channel 01 through 03 on the module in Slot1, channel 01 on the module in Slot3 and channel 06 through 08 on the module in Slot4;	None

- Explanation**
- The channels specified in <scan\_list> overwrites the current scan list. To start the scan, use the [INITiate](#) or [READ?](#) command.
  - To remove all the channels from the scan list, issue the ROUT:SCAN (@) command.
  - The instrument scans the list of channels in ascending order from Slot1 through slot 5. The instrument stores the channel numbers in ascending order even when you have already defined the order of the channels in the scan list. For Example, when the channel numbers in the scan list are defined as (@211:201), the instrument stores the channel numbers in 201, 202, 203... order.
  - You can use either the DMM module or an external multimeter to make measurements of the specified channels. However, M300 only allows one scan list at a time; you cannot measure some channels using the DMM module and others using an external multimeter. Readings are stored in the memory only when the DMM module is used (except the DIO and TOT channels).
  - You can store at most 10,0000 readings in the memory and all the readings are automatically time stamped. If the memory overflows, the new readings will overwrite the oldest readings stored.
  - Each time you start a new scan, the instrument clears all the readings stored in the reading memory from the previous scan. Therefore, the readings in the memory are always from the most recent scan.
  - If you abort a scan that is running (refer to the [ABORT](#) command), the instrument will terminate the measurement (readings are not cleared from the memory) and you cannot resume the scan from where it left off. Note that if you initiate a new scan, all the previous readings are cleared from the memory.
  - The current scan list is stored in the non-volatile memory (refer to [Appendix C: Non-volatile Memory](#)) and will not be cleared when power is turned off (the power-on value is set to "LAST", refer to the [SYSTEM:UTILITY:CONFIGure:POWERon](#) command).
  - <scan\_list> overwrites the current scan list.

**Return Format**

The query returns the channels in the scan list. The return format is as follows.

Format explanation:

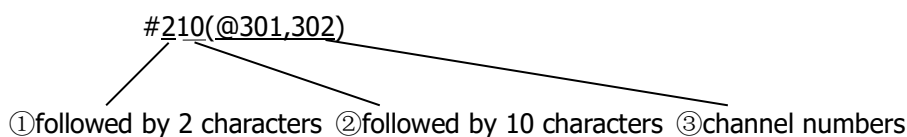

**Example** CONF:VOLT:AC 20,0.001,(@203:205)  
ROUT:SCAN (@203:205)  
READ?

The query returns +1.092823557E-01,+1.092155667E-01,+1.082497025E-01.

ROUT:SCAN?

The query returns #214(@203,204,205).

**Related commands** [ROUTe Command Subsystem](#)  
[ROUTE:SCAN:SIZE?](#)  
[FETCh?](#)

## ROUTE:SCAN:SIZE?

**Syntax** ROUTe:SCAN:SIZE?

**Description** Query the number of channels in the scan list.

**Explanation** The current scan list is stored in the non-volatile memory (refer to [Appendix C: Non-volatile Memory](#)) and will not be cleared when power is turned off (the power-on value is set to "LAST", refer to the [SYSTEM:UTILITY:CONFigure:POWEron](#) command).

**Return Format** The query returns a signed integer.

**Example** ROUT:SCAN (@305:307)  
ROUT:SCAN:SIZE?

The query returns +3.

**Related commands** [ROUTe Command Subsystem](#)  
[ROUTE:SCAN](#)

## SENSe Command Subsystem

- [\[SENSe:\]ANYSensor:FREQuency:RANGe:LOWer](#)
- [\[SENSe:\]ANYSensor:VOLTag:e:APERture](#)
- [\[SENSe:\]ANYSensor:VOLTag:e:NPLC](#)
- [\[SENSe:\]ANYSensor:CURRent:APERture](#)
- [\[SENSe:\]ANYSensor:CURRent:NPLC](#)
- [\[SENSe:\]ANYSensor:SEGMent](#)
- [\[SENSe:\]ANYSensor:SEGMent:CLEar](#)
- [\[SENSe:\]ANYSensor:TYPE](#)
- [\[SENSe:\]CURRent:AC:BANdwidth](#)
- [\[SENSe:\]CURRent:AC:RANGe](#)
- [\[SENSe:\]CURRent\[:DC\]:RANGe](#)
- [\[SENSe:\]CURRent:AC:RANGe:AUTO](#)
- [\[SENSe:\]CURRent\[:DC\]:RANGe:AUTO](#)
- [\[SENSe:\]CURRent:AC:RESolution](#)
- [\[SENSe:\]CURRent\[:DC\]:APERture](#)
- [\[SENSe:\]CURRent\[:DC\]:NPLC](#)
- [\[SENSe:\]CURRent\[:DC\]:RESolution](#)
- [\[SENSe:\]DIGital:DATA\[:BYTE\]?](#)
- [\[SENSe:\]DIGital:DATA:WORD?](#)
- [\[SENSe:\]DIGital:DATA:DWORD?](#)
- [\[SENSe:\]DIGital:TYPE](#)
- [\[SENSe:\]DIGital:LEVel](#)
- [\[SENSe:\]DIGital:THReshold](#)
- [\[SENSe:\]FREQuency:APERture](#)
- [\[SENSe:\]PERiod:APERture](#)
- [\[SENSe:\]FREQuency:RANGe:LOWer](#)
- [\[SENSe:\]PERiod:RANGe:LOWer](#)
- [\[SENSe:\]FREQuency:VOLTag:e:RANGe](#)
- [\[SENSe:\]PERiod:VOLTag:e:RANGe](#)
- [\[SENSe:\]FREQuency:VOLTag:e:RANGe:AUTO](#)
- [\[SENSe:\]PERiod:VOLTag:e:RANGe:AUTO](#)
- [\[SENSe:\]FUNctioN](#)
- [\[SENSe:\]TEMPerature:APERture](#)
- [\[SENSe:\]TEMPerature:NPLC](#)
- [\[SENSe:\]TEMPerature:RJUNctioN?](#)
- [\[SENSe:\]TEMP:TRANsducer:FRTD:OCOMpensated](#)
- [\[SENSe:\]TEMP:TRANsducer:RTD:OCOMpensated](#)

- [\[SENSe:\]TEMPerature:TRANsducer:FRTD:RESistance\[:REFerence\]](#)
- [\[SENSe:\]TEMPerature:TRANsducer:RTD:RESistance\[:REFerence\]](#)
- [\[SENSe:\]TEMPerature:TRANsducer:FRTD:TYPE](#)
- [\[SENSe:\]TEMPerature:TRANsducer:RTD:TYPE](#)
- [\[SENSe:\]TEMPerature:TRANsducer:TCouple:CHECK](#)
- [\[SENSe:\]TEMPerature:TRANsducer:TCouple:RJUNction:TYPE](#)
- [\[SENSe:\]TEMPerature:TRANsducer:TCouple:RJUNction](#)
- [\[SENSe:\]TEMPerature:TRANsducer:TCouple:TYPE](#)
- [\[SENSe:\]TEMPerature:TRANsducer:THERmistor:TYPE](#)
- [\[SENSe:\]TEMPerature:TRANsducer:TYPE](#)
- [\[SENSe:\]TOTAlize:CLEar:IMMediate](#)
- [\[SENSe:\]TOTAlize:DATA?](#)
- [\[SENSe:\]TOTAlize:SLOPe](#)
- [\[SENSe:\]TOTAlize:STARt\[:IMMediate\]](#)
- [\[SENSe:\]TOTAlize:STARt:DEFault](#)
- [\[SENSe:\]TOTAlize:STOP\[:IMMediate\]](#)
- [\[SENSe:\]TOTAlize:STOP:DEFault](#)
- [\[SENSe:\]TOTAlize:TYPE](#)
- [\[SENSe:\]TOTAlize:THReshold](#)
- [\[SENSe:\]VOLTagE:AC:RANGe](#)
- [\[SENSe:\]VOLTagE\[:DC\]:RANGe](#)
- [\[SENSe:\]VOLTagE:AC:RANGe:AUTO](#)
- [\[SENSe:\]VOLTagE\[:DC\]:RANGe:AUTO](#)
- [\[SENSe:\]VOLTagE:AC:BANDwidth](#)
- [\[SENSe:\]VOLTagE:AC:RESolution](#)
- [\[SENSe:\]VOLTagE\[:DC\]:APERture](#)
- [\[SENSe:\]VOLTagE\[:DC\]:NPLC](#)
- [\[SENSe:\]VOLTagE\[:DC\]:RESolution](#)
- [\[SENSe:\]ZERO:AUTO](#)

## [SENSe:]ANYSensor:FREQuency:RANGe:LOWer

**Syntax** [SENSe:]ANYSensor:FREQuency:RANGe:LOWer {<filter>|MIN|MAX}[,(@<ch\_list>)]  
 [SENSe:]ANYSensor:FREQuency:RANGe:LOWer? [{{(@<ch\_list>)|MIN|MAX}]

**Description** Set the AC filter parameter for the frequency measurements (anysensor function) of the specified channels.

Parameters	Name	Type	Range	Default
	<filter>	Numeric	Any integer between MIN and 1000000. The final AC filter parameter is decided by the " <b>Principle of setting with samller value</b> ". The standard values of the range: {3 20 200}	20Hz

		Wherein: MIN=3Hz, MAX=200Hz.	
<ch_list>	Channel List	<p>One or more channels (only for the multiplexer channels), the rules are as follows:</p> <p>(@101): channel 01 on the module in Slot1;  (@101:103): channel 01 through 03 on the module in Slot1;  (@101:103,301): channel 01 through 03 on the module in Slot1 and channel 01 on the module in Slot3.</p>	If the parameter is omitted, this command will be applied to the whole scan list.

- Explanation**
- Before using this command, please configure the specified channels to any sensor measurement function and the type of the sensor is **FREQ**. Otherwise, an error will be generated.
  - If <ch\_list> is omitted, the command will be applied to the whole scan list. At this point, make sure that all the channels in the scan list are configured to any sensor measurement function and the type of the sensor is **FREQ**. Otherwise, an error will be generated.
  - <filter> cannot be a decimal number. Otherwise, an error will be generated.
  - The [CONFigure:ANYSensor](#) or [MEASure:ANYSensor?](#) command automatically select 20 Hz as the AC filter parameter of the frequency measurement (any sensor) channel.
  - During the measurement, the filter type is determined by the frequency of the input signal of the current channel as shown in the table below.

Input Frequency	AC Filter Type
3 Hz to 300 kHz	3 Hz (slow)
20 Hz to 300 kHz	20 Hz (medium)
200 Hz to 300 kHz	200 Hz (fast)

- The instrument selects the 20 Hz filter automatically after a Factory Reset (send the [\\*RST](#) command). An Instrument Preset (send the [SYSTem:PRESet](#) command) or Card Reset (send the [SYSTem:CPON](#) command) does not affect the current AC filter parameter.

**Return Format** The query returns the AC filter parameter in scientific notation. Multiple return values are separated by commas.

**Example** ANYS:FREQ:RANG:LOW 200,(@301)  
ANYS:FREQ:RANG:LOW? (@301)

The query returns 2.000000000E+02.

**Related command** [SENSe Command Subsystem](#)

## [SENSe:]ANYSensor:VOLTage:APERture

**Syntax** [SENSe:]ANYSensor:VOLTage:APERture {<time>|MIN|MAX}[,(@<ch\_list>)]  
[SENSe:]ANYSensor:VOLTage:APERture? [,@<ch\_list>]|MIN|MAX}

**Description** Set the integration time via the aperture time mode for the DCV measurements (the anysensor measurement function) on the specified channels.

**Parameters**

Name	Type	Range of Values	Default Value
<time>	Numeric	Any numeric value between MIN and MAX. MIN=33 μs, MAX=4 s.	None
<ch_list>	Channel	One or more channels (only for the	If the parameter is

List	<p>multiplexer channels), the rules are as follows:</p> <p>(@101): channel 01 on the module in Slot1;</p> <p>(@101:103): channel 01 through 03 on the module in Slot1.</p>	<p>omitted, this command will be applied to the whole scan list.</p>
------	--	--

- Explanation**
- Before using this command, please configure the specified channels to any sensor measurement function and the type of the sensor is DCV. Otherwise, an error will be generated.
  - If <ch\_list> is omitted, the command will be applied to the whole scan list. At this point, make sure that all the channels in the scan list are configured to any sensor measurement function and the type of the sensor is DCV. Otherwise, an error will be generated.
  - The [CONFigure:ANYSensor](#), [MEASure:ANYSensor?](#) or [\[SENSe:\]ANYSensor:VOLTage:NPLC](#) command automatically disables the aperture time mode and enables the power line cycles mode.
  - You can use MIN or MAX to set <time>.
  - In the aperture time mode, the instrument selects the minimum resolution (namely, 0.03ppm× <range>).
  - The aperture time mode is disabled after a Factory Reset (send the [\\*RST](#) command). An Instrument Preset (send the [SYSTem:PRESet](#) command) or Card Reset (send the [SYSTem:CPON](#) command) does not affect the current integration time parameter.

**Return Format** The query returns the integration time in scientific notation for each channel specified. Multiple return values are separated by commas.

**Example** ANYS:VOLT:APER 0.01,(@201:203)  
 ANYS:VOLT:APER? (@201:203)

The query returns +1.00000000E-02,+1.00000000E-02,+1.00000000E-02.

**Related command** [SENSe Command Subsystem](#)

## [SENSe:]ANYSensor:VOLTage:NPLC

**Syntax** [SENSe:]ANYSensor:VOLTage:NPLC {<PLCs>|MIN|MAX}[,(@<ch\_list>)]  
 [SENSe:]ANYSensor:VOLTage:NPLC? [{(@<ch\_list>)|MIN|MAX}]

**Description** Set or query the integration time via the power line cycles mode for the DCV measurements (the anysensor measurement function) on the specified channels.

Parameters	Name	Type	Range	Default
	<PLCs>	Numeric	Any numeric value between MIN and MAX. The final integration time is decided by the " <b>Principle of setting with greater value</b> ". The standard values of the range: {0.02 0.2 1 2 10 20 100 200} Wherein: MIN=0.02PLC, MAX=200PLC.	1PLC
	<ch_list>	Channel List	One or more channels (only for the multiplexer channels), the rules are as follows: (@101): channel 01 on the module in Slot1;	If the parameter is omitted, this command will be applied to the whole scan list.



		(@101:103): channel 01 through 03 on the module in Slot1.	
--	--	---	--

- Explanation**
- Before using this command, please configure the specified channels to any sensor measurement function and the type of the sensor is DCV. Otherwise, an error will be generated.
  - If <ch\_list> is omitted, the command will be applied to the whole scan list. At this point, make sure that all the channels in the scan list are configured to any sensor measurement function and the type of the sensor is DCV. Otherwise, an error will be generated.
  - The longer the integration time is, the slower the measurement speed and the better the measurement resolution will be; the shorter the integration time is, the faster the measurement speed and the lower the measurement resolution will be.
  - You can also set the integration time via the aperture time mode (send the [\[SENSe:\]ANYSensor:VOLTage:APERture](#) command).
  - The instrument sets the integration time to 1 PLC after a Factory Reset (send the [\\*RST](#) command). An Instrument Preset (send the [SYSTem:PRESet](#) command) or Card Reset (send the [SYSTem:CPON](#) command) does not affect the current integration time parameter.

**Return Format** The query returns the integration time in scientific notation for each channel specified. Multiple return values are separated by commas.

**Example** ANYS:VOLT:NPLC 100,(@201:203)  
 ANYS:VOLT:NPLC? (@201:203)  
 The query returns +1.00000000E+02,+1.00000000E+02,+1.00000000E+02.

**Related commands** [SENSe Command Subsystem](#)  
[CONFigure:ANYSensor](#)  
[MEASure:ANYSensor?](#)

## [SENSe:]ANYSensor:CURRent:APERture

**Syntax** [SENSe:]ANYSensor:CURRent:APERture {<time>|MIN|MAX}[,(@<ch\_list>)]  
 [SENSe:]ANYSensor:CURRent:APERture? [{(@<ch\_list>)|MIN|MAX}]

**Description** Set the integration time via the aperture time mode for the DCI measurements (the anysensor measurement function) on the specified channels.

Parameters	Name	Type	Range	Default
	<time>	Numeric	Any numeric value between MIN and MAX. MIN=33 μs, MAX=4 s.	None
	<ch_list>	Channel List	One or more channels (only for channel 21 to channel 24 of MC3324), the rules are as follows: (@121): channel 21 on the module in Slot1; (@121:123): channel 21 through 23 on the module in Slot1; (@121:123,324): channel 21 through 23 on the module in Slot1 and channel 24 on the module in Slot3.	If the parameter is omitted, this command will be applied to the whole scan list.

- Explanation**
- Before using this command, please configure the specified channels to any sensor measurement function and the type of the sensor is DCI. Otherwise, an error will be

generated.

- If <ch\_list> is omitted, the command will be applied to the whole scan list. At this point, make sure that all the channels in the scan list are configured to any sensor measurement function and the type of the sensor is DCI. Otherwise, an error will be generated.
- The [CONFigure:ANYSensor](#), [MEASure:ANYSensor?](#) or [\[SENSe:\]ANYSensor:CURRent:NPLC](#) command automatically disables the aperture time mode and enables the power line cycles mode.
- You can use MIN or MAX to set <time>.
- In the aperture time mode, the instrument selects the minimum resolution (namely, 0.03ppm× <range>).
- The aperture time mode is disabled after a Factory Reset (send the [\\*RST](#) command). An Instrument Preset (send the [SYSTem:PRESet](#) command) or Card Reset (send the [SYSTem:CPON](#) command) does not affect the current integration time parameter.

**Return Format** The query returns the integration time in scientific notation for each channel. Multiple return values are separated by commas.

**Example** CONF:ANYS CURR,(@121:123)  
 ANYS:CURR:APER 1,(@121:123)  
 ANYS:CURR:APER? (@121:123)  
 The query returns +1.00000000E+00,+1.00000000E+00, +1.00000000E+00.

**Related command** [SENSe Command Subsystem](#)

## [SENSe:]ANYSensor:CURRent:NPLC

**Syntax** [SENSe:]ANYSensor:CURRent:NPLC {<PLCs>|MIN|MAX}[,(@<ch\_list>)]  
 [SENSe:]ANYSensor:CURRent:NPLC? [{(@<ch\_list>)|MIN|MAX}]

**Description** Set or query the integration time via the power line cycles mode for the DCI measurements (the anysensor measurement function) on the specified channels.

Parameters	Name	Type	Range of	Default
	<PLCs>	Numeric	Any numeric value between MIN and MAX. The final integration time is decided by the " <b>Principle of setting with greater value</b> ". The standard values of the range: {0.02 0.2 1 2 10 20 100 200} Wherein: MIN=0.02PLC, MAX=200PLC.	1PLC
	<ch_list>	Channel List	One or more channels (only for channel 21 to channel 24 of MC3324), the rules are as follows: (@121) :channel 21 on the module in Slot1; (@121:123): channel 21 through 23 on the module in Slot1; (@121:123,324): channel 21 through 23 on the module in Slot1 and channel 24 on the module in Slot3.	If the parameter is omitted, this command will be applied to the whole scan list.

**Explanation** ➤ Before using this command, please configure the specified channels to any sensor measurement function and the type of the sensor is DCI. Otherwise, an error will be generated.

- If <ch\_list> is omitted, the command will be applied to the whole scan list. At this point, make sure that all the channels in the scan list are configured to any sensor measurement function and the type of the sensor is DCI. Otherwise, an error will be generated.
- The longer the integration time is, the slower the measurement speed and the better the measurement resolution will be; the shorter the integration time is, the faster the measurement speed and the lower the measurement resolution will be.
- You can also set the integration time via the aperture time mode (send the [\[SENSe:\]ANYSensor:CURRent:APERture](#) command).
- The instrument sets the integration time to 1 PLC after a Factory Reset (send the [\\*RST](#) command). An Instrument Preset (send the [SYSTem:PRESet](#) command) or Card Reset (send the [SYSTem:CPON](#) command) does not affect the current integration time parameter.

**Return Format** The query returns the integration time in scientific notation for each channel specified. Multiple return values are separated by commas.

**Example** CONF:ANYS CURR,(@121:123)  
 ANYS:CURR:NPLC 0.2,(@121:123)  
 ANYS:CURR:NPLC? (@121:123)  
 The query returns +2.00000000E-01,+2.00000000E-01,+2.00000000E-01.

**Related commands** [SENSe Command Subsystem](#)  
[CONFigure:ANYSensor](#)  
[MEASure:ANYSensor?](#)

### [SENSe:]ANYSensor:SEGMENT

**Syntax** [SENSe:]ANYSensor:SEGMENT {<startvalue>, paraA, paraB, paraC}[,(@<ch\_list>)]  
 [SENSe:]ANYSensor:SEGMENT? (@<channel>)

**Description** Set or query the scaling parameters (including **SQUare**(A), **GAIN**(B), **CONSTant**(C), **Start**(startvalue)) for the anysensor measurements on the specified channels.

Parameters	Name	Type	Range	Default
	<startvalue>	Numeric	Any numeric value between MIN and MAX. MIN=-1.000000000E+15 MAX=+1.000000000E+15	0
	paraA			0
	paraB			1
	paraC			0
	<ch_list>	Channel List	One or more channels (only for the multiplexer channels), the rules are as follows:  (@101): channel 01 on the module in Slot1; (@101:103): channel 01 through 03 on the module in Slot1; (@101:103,301): channel 01 through 03 on the module in Slot1 and channel 01 on the module in Slot3.	If the parameter is omitted, this command will be applied to the whole scan list.
	<channel>	Channel	A single channel (only for the multiplexer channels), the rule is as follows:	None

		(@101): channel 1 on the module in Slot1.	
--	--	---	--

- Explanation**
- Before using this command, please configure the specified channels to any sensor measurement function. Otherwise, an error will be generated.
  - If <ch\_list> is omitted, the command will be applied to the whole scan list. At this point, make sure that all the channels in the scan list are configured to any sensor measurement function. Otherwise, an error will be generated.
  - The scaling formula for the anysensor is as follows.  

$$\text{Scaled Reading} = \mathbf{SQUare} \times (\text{Measurement} - \mathbf{Start})^2 + \mathbf{GAIN} \times (\text{Measurement} - \mathbf{Start}) + \mathbf{CONStant}$$
  - The scaling function is only applicable to the multiplexer channels. The specified channels must be part of the scan list and the DMM module must be installed and enabled.
  - If you change the measurement function, the scaling function is turned off and the scaling coefficients are reset (A=0, B=1, C=0, startvalue=0).
  - Configuring the scaling coefficients will turn off the alarm function and clear the alarm parameters. Therefore, configure the scaling coefficients before configuring the alarm parameters.
  - If the scaling parameters are the default values, querying these scaling parameters will return "+0".
  - A Factory Reset (send the [\\*RST](#) command) turns off the scaling function and clears the scaling coefficients (reset to the default values). An Instrument Preset (send the [SYSTem:PRESet](#) command) or Card Reset (send the [SYSTem:CPON](#) command) does not turn off the scaling function and does not clear the scaling coefficients.

**Return Format** The query returns a series of numbers, wherein the startvalue, A, B and C are in scientific notation. Multiple return values are separated by commas. The return format is as follows.

Format explanation:

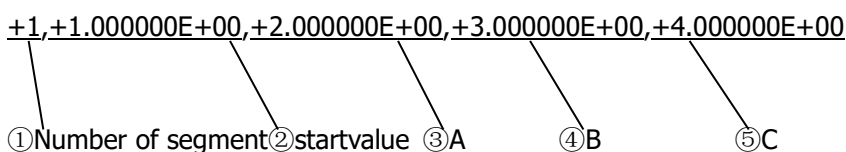

**Example** ANYS:SEGM 1,2,3,4,(@101)  
 ANYS:SEGM? (@101)

The query returns +1,+1.000000E+00,+2.000000E+00,+3.000000E+00,+4.000000E+00.

**Related command** [\[SENSe:\]ANYSensor:SEGMent:CLEar](#)

## [SENSe:]ANYSensor:SEGMent:CLEar

**Syntax** [SENSe:]ANYSensor:SEGMent:CLEar [<startvalue>],[(@<ch\_list>)]

**Description** Clear the scaling parameters of the anysensor measurements on the specified channels (<startvalue> specifies the the segment of the delete operation).

**Parameters**

Name	Type	Range	Default
<startvalue>	Numeric	The start value of the scaling segment	None

<ch_list>	Channel List	One or more channels (only for the multiplexer channels), the rules are as follows: (@101): channel 01 on the module in Slot1; (@101:103): channel 01 through 03 on the module in Slot1; (@101:103,301): channel 01 through 03 on the module in Slot1 and channel 01 on the module in Slot3.	If the parameter is omitted, this command will be applied to the whole scan list.
-----------	--------------	---	---

- Explanation**
- Before using this command, please configure the specified channels to any sensor measurement function. Otherwise, an error will be generated.
  - If <ch\_list> is omitted, the command will be applied to the whole scan list. At this point, make sure that all the channels in the scan list are configured to any sensor measurement function. Otherwise, an error will be generated.
  - When <startvalue> is omitted, the instrument clears the scaling parameters of all the segments of the of the anysensor measurements on the specified channels.
  - When the parameter specified by <startvalue> is not the start value of the scaling segment, an error will be generated when sending this command.
  - If you change the measurement function, the scaling function will be turned off and the scaling parameters will be reset (A=0, B=1, C=0, startvalue=0).
  - A Factory Reset (send the [\\*RST](#) command) turns off the scaling function and clears the scaling coefficients (reset to the default values). An Instrument Preset (send the [SYSTEM:PRESet](#) command) or Card Reset (send the [SYSTEM:CPON](#) command) does not turn off the scaling function and does not clear the scaling coefficients.

**Example**

```

ANYS:SEGM 1,2,3,4,@101
ANYS:SEGM? (@101

The query returns +1,+1.000000E+00,+2.000000E+00,+3.000000E+00,+4.000000E+00.

ANYS:SEGM:CLE (@101
ANYS:SEGM? (@101

The query returns +0.
    
```

**Related command** [\[SENSe:\]ANYSensor:SEGMent](#)

## [SENSe:]ANYSensor:TYPE

**Syntax** [SENSe:]ANYSensor:TYPE <type>[,(@<ch\_list>)]  
 [SENSe:]ANYSensor:TYPE? [(@<ch\_list>)]

**Description** Set or query the measurement type of the anysensor measurement on the specified channel.

**Parameters**

Name	Type	Range	Default
<type>	Discrete	{VOLT CURR FREQ}	VOLT or CURR <sup>[1]</sup>
<ch_list>	Channel List	One or more channels (only for the multiplexer channels), the rules are as follows: (@101): channel 01 on the module in Slot1; (@101:103): channel 01 through 03 on the	If the parameter is omitted, this command will be applied to the whole scan list.

		module in Slot1; (@101:103,301): channel 01 through 03 on the module in Slot1 and channel 01 on the module in Slot3.	
--	--	---	--

**Note**<sup>[1]</sup>: For channel 21 through channel 24 of MC3324, the default type of the anysensor is CURR; for other multiplexer channels, the default type of the anysensor is VOLT.

- Explanation**
- Before using this command, please configure the specified channels to any sensor measurement function. Otherwise, an error will be generated.
  - If <ch\_list> is omitted, the command will be applied to the whole scan list. At this point, make sure that all the channels in the scan list are configured to any sensor measurement function. Otherwise, an error will be generated.
  - <ch\_list> can only be the multiplexer channels.
- For channel 21 to channel 24 of MC3324, <type> can only be CURR;  
For all the channels of MC3164, <type> can not be CURR;  
For channel 1 to channel 20 of MC3324, the MC3120, and the MC3132, <type> can be either VOLT or FREQ.

**Return Format** The query returns VOLT (DCV), CURR (DCI), or FREQ (frequency).

**Example** ANYS:TYPE VOIT,(@101)  
ANYS:TYPE? (@101)  
The query returns VOLT.

**Related commands** [CONFigure:ANYSensor](#)  
[MEASure:ANYSensor?](#)

## [SENSE:]CURRENT:AC:BANDwidth

**Syntax** [SENSE:]CURRENT:AC:BANDwidth {<filter>|MIN|MAX}[,(@<ch\_list>)]  
[SENSE:]CURRENT:AC:BANDwidth? [({@<ch\_list>})|MIN|MAX]

**Description** Set or query the AC filter parameter of the ACI measurements on the specified channels.

Parameters	Name	Type	Range	Default
	<filter>	Numeric	Any integer between MIN and 1000000. The final AC filter parameter is decided by the " <b>Principle of setting with smaller value</b> ". The standard values of the range: {3 20 200} Wherein: MIN=3Hz, MAX=200Hz.	20Hz
	<ch_list>	Channel List	One or more channels (only for channel 21 to channel 24 of MC3324), the rules are as follows: (@121): channel 21 on the module in Slot1; (@121:123): channel 21 through 23 on the module in Slot1; (@121:123,324): channel 21 through 23 on the module in Slot1 and channel 24 on the module in Slot3.	If the parameter is omitted, this command will be applied to the whole scan list.

- Explanation**
- Before using this command, please configure the specified channels to AC current measurement function. Otherwise, an error will be generated.
  - If <ch\_list> is omitted, the command will be applied to the whole scan list. At this

point, make sure that all the channels in the scan list are configured to AC current measurement function. Otherwise, an error will be generated.

- <filter> cannot be a decimal number. Otherwise, an error will be generated.
- The [CONFigure:CURRent:AC](#) and [MEASure:CURR:AC?](#) command automatically select the 20 Hz filter.
- During the measurement, the filter type is determined by the frequency of the input signal of the current channel as shown in the table below.

Input Frequency	AC Filter Type
3 Hz to 300 kHz	3 Hz (slow)
20 Hz to 300 kHz	20 Hz (medium)
200 Hz to 300 kHz	200 Hz (fast)

- The instrument selects the 20 Hz filter automatically after a Factory Reset (send the [\\*RST](#) command). An Instrument Preset (send the [SYSTem:PRESet](#) command) or Card Reset (send the [SYSTem:CPON](#) command) does not affect the current AC filter parameter.

**Return Format** The query returns the AC filter parameter in scientific notation for each channel specified. Multiple return values are separated by commas.

**Example** CURR:AC:BAND 20,(@121)  
 CURR:AC:BAND 3,(@122)  
 CURR:AC:BAND? (@121,122)

The query returns 2.000000000E+01,3.000000000E+00.

## [SENSe:]CURRent:AC:RANGe

## [SENSe:]CURRent[:DC]:RANGe

**Syntax** [SENSe:]CURRent:AC:RANGe {<range>|MIN|MAX}{,(@<ch\_list>)}  
 [SENSe:]CURRent:AC:RANGe? [{(@<ch\_list>)|MIN|MAX}]  
 [SENSe:]CURRent[:DC]:RANGe:AUTO <state>{,(@<ch\_list>)}  
 [SENSe:]CURRent[:DC]:RANGe:AUTO? [{(@<ch\_list>)}]

**Description** Set or query the measurement range of the ACI and DCI measurements on the specified channels.

**Parameters**

Name	Type	Range	Default
<range>	Numeric	Any numeric value between 0 and 110*MAX. The final range is decided by the " <b>Principle of setting with greater value</b> " when <range> is between 0 and MAX; the final range is MAX when <range> is greater than MAX. The standard values of the range: {200μA 2mA 20mA 200mA 1A} Wherein: MIN=200μA, MAX=1A, DEF=AUTO.	AUTO
<ch_list>	Channel List	One or more channels (only for channel 21 to channel 24 of MC3324), the rules are as follows: (@121): channel 21 on the module in Slot1; (@121:123): channel 21 through 23 on the	If the parameter is omitted, this command will be applied to the whole scan list.

		module in Slot1; (@121:123,324): channel 21 through 23 on the module in Slot1 and channel 24 on the module in Slot3.	
--	--	---	--

- Explanation**
- Before using this command, please configure the specified channels to AC current or DC current measurement function. Otherwise, an error will be generated.
  - If <ch\_list> is omitted, the command will be applied to the whole scan list. At this point, make sure that all the channels in the scan list are configured to AC current or DC current measurement function. Otherwise, an error will be generated.
  - Selecting a specific range for the specified channel will disable the autoranging (refer to the [\[SENSe:\]CURRent:AC:RANGe:AUTO](#) and [\[SENSe:\]CURRent\[:DC\]:RANGe:AUTO](#) commands).
  - The [CONFigure:CURRent:AC \(CONFigure:CURRent\[:DC\]\)](#) or [MEASure:CURR:AC? \(MEASure:CURR\[:DC\]?\)](#) command automatically enables the autoranging if the first parameter is AUTO, DEF or omitted.
  - If the input signal is greater than can be measured on the selected range, the instrument gives an overload indication: "OVERLOAD" from the front panel or "±9.9E+37" from the remote interface.
  - The instrument selects autoranging after a Factory Reset (send the [\\*RST](#) command). An Instrument Preset (send the [SYSTem:PRESet](#) command) or Card Reset (send the [SYSTem:CPON](#) command) does not affect the current range setting.

**Return Format** The query returns the range of the specified channel in scientific notation. Multiple return values are separated by commas.

**Example** CURR:AC:RANG 0.2,(@222,223)  
CURR:AC:RANG? (@222,223)

The query returns +2.00000000E-01,+2.00000000E-01.

You can replace AC with DC to select the measurement range of the DCI measurements on the specified channels.

## **[SENSe:]CURRent:AC:RANGe:AUTO** **[SENSe:]CURRent[:DC]:RANGe:AUTO**

**Syntax** [SENSe:]CURRent:AC:RANGe:AUTO <state>[,(@<ch\_list>)]  
[SENSe:]CURRent:AC:RANGe:AUTO? [(@<ch\_list>)]  
[SENSe:]CURRent:DC:RANGe:AUTO <state>[,(@<ch\_list>)]  
[SENSe:]CURRent:DC:RANGe:AUTO? [(@<ch\_list>)]

**Description** Disable or enable the autoranging of the ACI and DCI measurements on the specified channels.

Parameters	Name	Type	Range	Default
	<state>	Bool	{OFF 0 ON 1}	ON
	<ch_list>	Channel List	One or more channels (only for channel 21 to channel 24 of MC3324), the rules are as follows: (@121): channel 21 on the module in Slot1; (@121:123): channel 21 through 23 on the module in Slot1; (@121:123,324): channel 21 through 23 on the module in Slot1 and channel 24 on the	If the parameter is omitted, this command will be applied to the whole scan list.



	module in Slot3.	
--	------------------	--

- Explanation**
- Before using this command, please configure the specified channels to AC current or DC current measurement function. Otherwise, an error will be generated.
  - If <ch\_list> is omitted, the command will be applied to the whole scan list. At this point, make sure that all the channels in the scan list are configured to AC current or DC current measurement function. Otherwise, an error will be generated.
  - Autoranging rule: for signals under test that is between 10%\*Range and 110%\*Range, the instrument automatically selects Range as the current range.
  - Selecting a specific range for the specified channel will disable the autoranging (send the [\[SENSe:\]CURRent:AC:RANGe](#) and [\[SENSe:\]CURRent\[:DC\]:RANGe](#) commands).
  - The [CONFigure:CURRent:AC](#) ([CONFigure:CURRent\[:DC\]](#)) or [MEASure:CURR:AC?](#) ([MEASure:CURR\[:DC\]?](#)) command automatically enables the autoranging if the first parameter is AUTO, DEF or omitted.
  - The instrument selects autoranging after a Factory Reset (send the [\\*RST](#) command). An Instrument Preset (send the [SYSTem:PRESet](#) command) or Card Reset (send the [SYSTem:CPON](#) command) does not affect the current range setting.

**Return Format** The query returns 0 (OFF) or 1 (ON). Multiple return values are separated by commas.

**Example** CURR:AC:RANG:AUTO 1, (@321:322)  
CURR:AC:RANG:AUTO? (@321:322,324)

The query returns 1,1,0.

You can replace AC with DC to disable or enable the autoranging of the DCI measurements on the specified channels.

## [SENSe:]CURRent:AC:RESolution

**Syntax** [SENSe:]CURRent:AC:RESolution {<resolution>|MIN|MAX}{,(@<ch\_list>)}  
[SENSe:]CURRent:AC:RESolution? [{{(@<ch\_list>)}|MIN|MAX}]

**Description** Set or query the resolution of the ACI measurements on the specified channels.

**Parameters**

Name	Type	Range	Default
<resolution>	Numeric	Can receive any numeric value, but the resolution is fixed at 6 <sup>1/2</sup> digits.	
<ch_list>	Channel List	One or more channels (only for channel 21 to channel 24 of MC3324), the rules are as follows: (@121): channel 21 on the module in Slot1; (@121:123): channel 21 through 23 on the module in Slot1; (@121:123,324): channel 21 through 23 on the module in Slot1 and channel 24 on the module in Slot3.	If the parameter is omitted, this command will be applied to the whole scan list.

- Explanation**
- Before using this command, please configure the specified channels to AC current measurement function. Otherwise, an error will be generated.
  - If <ch\_list> is omitted, the command will be applied to the whole scan list. At this point, make sure that all the channels in the scan list are configured to AC current measurement function. Otherwise, an error will be generated.

- When the range is set to autoranging, an error will be generated when <resolution> is set to a numeric value (except MIN and MAX).

**Return Format** The query returns the resolution of the specified channel in scientific notation. Multiple return values are separated by commas.

**Example** CURR:AC:RES MIN,(@121)  
CURR:AC:RES? (@121)

The query returns +1.00000000E-06.

**Related commands** [\[SENSe:\]CURRent:AC:RANGe:AUTO](#)  
[\[SENSe:\]CURRent:AC:RANGe](#)  
[CONFigure:CURRent:AC](#)  
[MEASure:CURR:AC?](#)

## [SENSe:]CURRent[:DC]:APERture

**Syntax** [SENSe:]CURRent[:DC]:APERture {<time>|MIN|MAX}{,(@<ch\_list>)]  
[SENSe:]CURRent[:DC]:APERture? [{(@<ch\_list>)|MIN|MAX}]

**Description** Set the integration time via the aperture time mode for the DCI measurements on the specified channels.

Parameters	Name	Type	Range	Default
	<time>	Numeric	Any numeric value between MIN and MAX. Wherein: MIN=33 $\mu$ s, MAX=4 s.	None
	<ch_list>	Channel List	One or more channels (only for channel 21 to channel 24 of MC3324), the rules are as follows: (@121): channel 21 on the module in Slot1; (@121:123): channel 21 through 23 on the module in Slot1; (@121:123,324): channel 21 through 23 on the module in Slot1 and channel 24 on the module in Slot3.	If the parameter is omitted, this command will be applied to the whole scan list.

- Explanation**
- Before using this command, please configure the specified channels to DC current measurement function. Otherwise, an error will be generated.
  - If <ch\_list> is omitted, the command will be applied to the whole scan list. At this point, make sure that all the channels in the scan list are configured to DC current measurement function. Otherwise, an error will be generated.
  - The [CONFigure:CURRent\[:DC\]](#), [MEASure:CURR\[:DC\]?](#), [\[SENSe:\]CURRent\[:DC\]:NPLC](#) or [\[SENSe:\]CURRent\[:DC\]:RESolution](#) command automatically disables the aperture time mode and enables the power line cycles mode.
  - You can use MIN or MAX to set <time>.
  - In the aperture time mode, the instrument selects the minimum resolution (namely, 0.03ppm× <range>).
  - The aperture time mode is disabled after a Factory Reset (send the [\\*RST](#) command). An Instrument Preset (send the [SYSTem:PRESet](#) command) or Card Reset (send the [SYSTem:CPON](#) command) does not affect the current integration time parameter.

**Return Format** The query returns the integration time in scientific notation for each channel. Multiple return values are separated by commas.

**Example** CONF:CURR:DC (@121:123)  
 CURR:DC:APER 1,(@121:123)  
 CURR:DC:APER? (@121:123)

The query returns +1.00000000E+00,+1.00000000E+00, +1.00000000E+00.

## [SENSe:]CURRent[:DC]:NPLC

**Syntax** [SENSe:]CURRent[:DC]:NPLC {<PLCs>|MIN|MAX}[,(@<ch\_list>)]

[SENSe:]CURRent[:DC]:NPLC? [{(@<ch\_list>)|MIN|MAX}]

**Description** Set or query the integration time via the power line cycles mode for the DCI measurements on the specified channels.

Parameters	Name	Type	Range	Default
	<PLCs>	Numeric	Any numeric value between MIN and MAX. The final integration time is decided by the " <b>Principle of setting with greater value</b> ". The standard values of the range: {0.02 0.2 1 2 10 20 100 200} Wherein: MIN=0.02PLC, MAX=200PLC.	1PLC
	<ch_list>	Channel List	One or more channels (only for channel 21 to channel 24 of MC3324), the rules are as follows: (@121): channel 21 on the module in Slot1; (@121:123): channel 21 through 23 on the module in Slot1; (@121:123,324): channel 21 through 23 on the module in Slot1 and channel 24 on the module in Slot3.	If the parameter is omitted, this command will be applied to the whole scan list.

- Explanation**
- Before using this command, please configure the specified channels to DC current measurement function. Otherwise, an error will be generated.
  - If <ch\_list> is omitted, the command will be applied to the whole scan list. At this point, make sure that all the channels in the scan list are configured to DC current measurement function. Otherwise, an error will be generated.
  - The longer the integration time is, the slower the measurement speed and the better the measurement resolution will be; the shorter the integration time is, the faster the measurement speed and the lower the measurement resolution will be.
  - You can also set the integration time via the aperture time mode (send the [\[SENSe:\]CURRent\[:DC\]:APERture](#) command).
  - The instrument sets the integration time to 1 PLC after a Factory Reset (send the [\\*RST](#) command). An Instrument Preset (send the [SYSTem:PRESet](#) command) or Card Reset (send the [SYSTem:CPON](#) command) does not affect the current integration time parameter.

**Return Format** The query returns the integration time in scientific notation for each channel specified. Multiple return values are separated by commas.

**Example** CONF:CURR:DC (@121:123)  
 CURR:DC:NPLC 0.2,(@121:123)  
 CURR:DC:NPLC? (@121:123)

The query returns +2.00000000E-01,+2.00000000E-01,+2.00000000E-01.

**Related commands** [\[SENSe:\]CURRent\[:DC\]:RESolution](#)

[CONFigure:CURRent\[:DC\]](#)

[MEASure:CURR\[:DC\]?](#)

## [SENSe:]CURRent[:DC]:RESolution

**Syntax** [SENSe:]CURRent[:DC]:RESolution {<resolution>|MIN|MAX}[,@<ch\_list>]

[SENSe:]CURRent[:DC]:RESolution? [{(@<ch\_list>)|MIN|MAX}]

**Description** Set or query the resolution of the DCI measurements on the specified channels.

### Parameters

Name	Type	Range	Default
<resolution>	Numeric	Any numeric value between 0.03ppm×<range> and 3ppm×<range>. The final resolution is decided by the " <b>Principle of setting with smaller value</b> ". The standard values of the resolution: refer to the " <b>Explanation</b> ".	0.3ppm×<range>
<ch_list>	Channel List	One or more channels (only for channel 21 to channel 24 of MC3324), the rules are as follows: (@121): channel 21 on the module in Slot1; (@121:123): channel 21 through 23 on the module in Slot1; (@121:123,324): channel 21 through 23 on the module in Slot1 and channel 24 on the module in Slot3.	If the parameter is omitted, this command will be applied to the whole scan list.

- Explanation**
- Before using this command, please configure the specified channels to DC current measurement function. Otherwise, an error will be generated.
  - If <ch\_list> is omitted, the command will be applied to the whole scan list. At this point, make sure that all the channels in the scan list are configured to DC current measurement function. Otherwise, an error will be generated.
  - You can use MIN or MAX to set <resolution>. Wherein, MIN selects the smallest resolution; MAX selects the largest resolution.
  - <resolution> is related to the current integration time and range (<range>). The relations are as shown in the table below.

Integration time	Resolution (ppm range)
0.02PLC	3ppm× <range> (MAX)
0.2PLC	0.7ppm× <range>
1PLC	0.3ppm× <range> (DEF)
2PLC	0.2ppm× <range>
10PLC	0.1ppm× <range>
20PLC	0.06ppm× <range>
100PLC	0.035ppm× <range>
200PLC	0.03ppm× <range> (MIN)
Aperture Time Mode	0.03ppm× <range> (MIN)

- When the range is set to autoranging, an error will be generated when <resolution> is set to a numeric value (except MIN and MAX).
- The instrument sets the resolution to 0.3ppm× <range> after a Factory Reset (send the [\\*RST](#) command). An Instrument Preset (send the [SYSTem:PRESet](#) command) or

Card Reset (send the [SYSTem:CPON](#) command) does not affect the current resolution.

**Return Format** The query returns the resolution in the form of scientific notation for each channel specified. Multiple responses are separated by commas.

**Example** CURR:DC:RANG 1,(@121,122)  
CURR:DC:RES 0.00001,(@121,122)  
CURR:DC:RES? (@121,122)

The query returns +3.00000000E-06,+3.00000000E-06.

**Related commands** [\[SENSe:\]CURRent\[:DC\]:APERTure](#)  
[\[SENSe:\]CURRent\[:DC\]:NPLC](#)  
[\[SENSe:\]CURRent\[:DC\]:RANGe](#)  
[\[SENSe:\]CURRent\[:DC\]:RANGe:AUTO](#)  
[CONFigure:CURRent\[:DC\]](#)  
[MEASure:CURR\[:DC\]?](#)

## [SENSe:]DIGital:DATA[:BYTE]? [SENSe:]DIGital:DATA:WORD? [SENSe:]DIGital:DATA:DWORd?

**Syntax** [SENSe:]DIGital:DATA[:BYTE]? (@<ch\_list>)  
[SENSe:]DIGital:DATA:WORD? (@<ch\_list>)  
[SENSe:]DIGital:DATA:DWORd? (@<ch\_list>)

**Description** Set the bits of the specified DIO channels when they are used as the digital input terminals and query the digital input values of the specified DIO channels. BYTE represents 8-bit, WORD represents 16-bit and DWORd represents 32-bit.

Parameters	Name	Type	Range	Default
	<ch_list>	Channel List	One or more channels (only for channel 01 through 04 of the multifunction module), the rules are as follows:  (@101): channel 01 on the module in Slot1; (@101:103): channel 01 through 03 on the module in Slot1; (@101:103,301): channel 01 through 03 on the module in Slot1 and channel 01 on the module in Slot3.	None

**Explanation**

- The digital input channels are numbered as "S01" to "S04"; wherein,S is the number of the slot.
- The [SENSe:]DIGital[:BYTE] (@<ch\_list>) command is applicable to S01 to S04. The [SENSe:]DIGital:WORD (@<ch\_list>) command is only applicable to S01 and S03. At this point, S01 (LSB) and S02 (MSB) as well as S03 (LSB) and S04 (MSB) are configured as two 16-bit digital input terminals. The [SENSe:]DIGital:DWORd (@<ch\_list>) command is only applicable to S01. At this point, S01 (LSB), S02, S03 and S04 (MSB) are configured as a 32-bit digital input terminal.
- If (@<ch\_list>) does not match the above conditions, an error will be generated.
- The return format of this command is affected by the settings of the [FORMat Command Subsystem](#) commands. Depending on the settings, each reading may or

may not contain the measurement units, time stamp, channel number and alarm status information.

**Return Format** The query returns the digital input values of the specified channels in scientific notation (the format is set by the command in the [FORMat Command Subsystem](#)). Multiple return values are separated by commas.

**Example** DIG:DATA:BYTE? (@201,202)  
The query returns +2.550000000E+02,+2.550000000E+02.

**Related commands** [CONFigure:DIgital:BYTE](#)  
[CONFigure:DIgital:WORD](#)  
[CONFigure:DIgital:DWORd](#)

## [SENSe:]DIGital:TYPE

**Syntax** [SENSe:]DIGital:TYPE {USER|TTL|CMOS5|CMOS3.3|CMOS2.5},[(@<ch\_list>)]  
[SENSe:]DIGital:TYPE? [(@<ch\_list>)]

**Description** Set the level type of the digital input and output of the specified channels.

### Parameters

Name	Type	Range	Default
TYPE	Discrete	{USER TTL CMOS5 CMOS3.3 CMOS2.5}	TTL
<ch_list>	Channel List	One or more channels (only for the channel 01 through 04 of the multifunction module), the rules are as follows: (@101): channel 01 on the module in Slot1; (@101:103): channel 01 through 03 on the module in Slot1; (@101:103,301): channel 01 through 03 on the module in Slot1 and channel 01 on the module in Slot3.	None

- Explanation**
- The digital channels are numbered "S01" to "S04"; wherein, S is the number of the slot.
  - This command is valid for both the level types of the digital input and output.
  - If the specified channels are configured as 32-bit digital input (send the [CONFigure:DIgital:DWORd](#), [MEASure:DIgital:DWORd?](#) or [\[SENSe:\]DIgital:DATA:DWORd?](#) command) or output (send the [SOURce:DIgital:DATA:DWORd](#) command), <ch\_list> can only be S01, wherein S is the number of the slot of the multifunction module.

If the specified channels are configured as 16-bit digital input (send the [CONFigure:DIgital:WORD](#), [MEASure:DIgital:WORD?](#) or [\[SENSe:\]DIgital:DATA:WORD?](#) command) or output (send the [SOURce:DIgital:DATA:WORD](#) command), <ch\_list> can only be S01 or S03, wherein S is the number of the slot of the multifunction module.

If the specified channels are configured as 8-bit digital input (send the [CONFigure:DIgital:BYTE](#), [MEASure:DIgital:BYTE?](#) or [\[SENSe:\]DIgital:DATA\[:BYTE\]?](#) command) or output (send the [SOURce:DIgital:DATA\[:BYTE\]](#) command), <ch\_list> can be S01, S02, S03 or S04, wherein S is the number of the slot of the multifunction module.

- The instrument sets the level type to TTL after a Factory Reset (send the [\\*RST](#) command). An Instrument Preset (send the [SYSTem:PRESet](#) command) or Card Reset

(send the [SYSTem:CPON](#) command) does not affect the current level type.

**Return Format** The query returns "USER", "TTL", "CMOS5", "CMOS3.3" or "CMOS2.5". Multiple returned values are separated by commas.

**Example** DIG:TYPE TTL,(@201)  
DIG:TYPE? (@201)

The query returns "TTL".

**Related commands** [\[SENSe:\]DIGital:LEVel](#)  
[\[SENSe:\]DIGital:THReshold](#)

## [SENSe:]DIGital:LEVel

**Syntax** [SENSe:]DIGital:LEVel <level>,[(@<ch\_list>)]  
[SENSe:]DIGital:LEVel? [(@<ch\_list>)]

**Description** Set or query the digital output level values of the specified channels (the level type is set to USER).

**Parameters**

Name	Type	Range	Default
<level>	Numeric	Any numeric value between 2V and 5V.	5V
<ch_list>	Channel List	One or more channels (only for the channel 01 through 04 of the multifunction module), the rules are as follows:  (@101): channel 01 on the module in Slot1; (@101:103): channel 01 through 03 on the module in Slot1; (@101:103,301): channel 01 through 03 on the module in Slot1 and channel 01 on the module in Slot3.	None

- Explanation**
- The digital input channels are numbered as "S01" to "S04", wherein, S is the number of the slot.
  - If the specified channels are configured as 32-bit digital input (send the [CONFigure:DIgital:DWORd](#), [MEASure:DIgital:DWORd?](#) or [\[SENSe:\]DIgital:DATA:DWORd?](#) command) or output (send the [SOURce:DIgital:DATA:DWORd](#) command), <ch\_list> can only be S01, wherein S is the number of the slot of the multifunction module.  
  
If the specified channels are configured as 16-bit digital input (send the [CONFigure:DIgital:WORD](#), [MEASure:DIgital:WORD?](#) or [\[SENSe:\]DIgital:DATA:WORD?](#) command) or output (send the [SOURce:DIgital:DATA:WORD](#) command), <ch\_list> can only be S01 or S03, wherein S is the number of the slot of the multifunction module.  
  
If the specified channels are configured as 8-bit digital input (send the [CONFigure:DIgital:BYTE](#), [MEASure:DIgital:BYTE?](#) or [\[SENSe:\]DIgital:DATA:BYTE?](#) command) or output (send the [SOURce:DIgital:DATA:BYTE](#) command), <ch\_list> can be S01, S02, S03 or S04, wherein S is the number of the slot of the multifunction module.
  - The default value of the level threshold is 2.5V. When sending this command to set the output level value of the specified DIO channel, please make sure <level>  $\geq$  the current level threshold +0.5V; otherwise, an error will be generated.
  - The instrument sets the level type to TTL after a Factory Reset (send the [\\*RST](#) command). An Instrument Preset (send the [SYSTem:PRESet](#) command) or Card Reset

(send the [SYSTEM:CPON](#) command) does not affect the current level type.

**Return Format** The query returns the level values of the specified channels in scientific notation. Multiple return values are separated by commas.

**Example** DIG:LEV 3,(@201)  
DIG:LEV? (@201)

The query returns +3.000000000E+00.

**Related commands** [\[SENSe:\]DIGital:THReshold](#)  
[\[SENSe:\]DIGital:TYPE](#)

## [SENSe:]DIGital:THReshold

**Syntax** [SENSe:]DIGital:THReshold <threshold>,[(@<ch\_list>)]  
[SENSe:]DIGital:THReshold? [(@<ch\_list>)]

**Description** Set or query the digital output level threshold values of the specified channels (the level type is set to USER).

Parameters	Name	Type	Range	Default
	<threshold>	Numeric	Any numeric value between 0.5V and 3.5V.	2.5V
	<ch_list>	Channel List	One or more channels (only for the 01 channel through 04 of the multifunction module), the rules are as follows:  (@101): channel 01 on the module in Slot1; (@101:103): channel 01 through 03 on the module in Slot1; (@101:103,301): channel 01 through 03 on the module in Slot1 and channel 01 on the module in Slot3.	None

- Explanation**
- The digital input channels are numbered as "S01" to "S04", wherein, S is the number of the slot.
  - If the specified channels are configured as 32-bit digital input (send the [CONFigure:DIgital:DWORd](#), [MEASure:DIgital:DWORd?](#) or [\[SENSe:\]DIgital:DATA:DWORd?](#) command) or output (send the [SOURce:DIgital:DATA:DWORd](#) command), <ch\_list> can only be S01, wherein S is the number of the slot of the multifunction module.  
  
If the specified channels are configured as 16-bit digital input (send the [CONFigure:DIgital:WORd](#), [MEASure:DIgital:WORd?](#) or [\[SENSe:\]DIgital:DATA:WORd?](#) command) or output (send the [SOURce:DIgital:DATA:WORd](#) command), <ch\_list> can only be S01 or S03, wherein S is the number of the slot of the multifunction module.  
  
If the specified channels are configured as 8-bit digital input (send the [CONFigure:DIgital:BYTE](#), [MEASure:DIgital:BYTE?](#) or [\[SENSe:\]DIgital:DATA\[:BYTE\]?](#) command) or output (send the [SOURce:DIgital:DATA\[:BYTE\]](#) command), <ch\_list> can be S01, S02, S03 or S04, wherein S is the number of the slot of the multifunction module.
  - The default level is 5V. When sending this command to set the input level threshold of the specified DIO channel, please make sure <threshold> is lower than or equal to the level -0.5V; otherwise, an error will be generated.
  - When the input signal < Threshold-0.3 V, it is regarded as logic 0;



When the input signal  $> \text{Threshold} + 0.3 \text{ V}$ , it is regarded as logic 1.

- The instrument sets the level type to TTL after a Factory Reset (send the [\\*RST](#) command). An Instrument Preset (send the [SYSTem:PRESet](#) command) or Card Reset (send the [SYSTem:CPON](#) command) does not affect the current level type.

**Return Format** The query returns the level threshold values of the specified channels in scientific notation. Multiple return values are separated by commas.

**Example** DIG:THR 1.5,(@201)  
DIG:THR? (@201)  
The query returns +1.500000000E+00.

**Related commands** [\[SENSe:\]DIGital:TYPE](#)  
[\[SENSe:\]DIGital:LEVel](#)

## [SENSe:]FREQuency:APERture [SENSe:]PERiod:APERture

**Syntax** [SENSe:]FREQuency:APERture {<seconds>|MIN|MAX}{,(@<ch\_list>)}  
[SENSe:]FREQuency:APERture? [{(@<ch\_list>)|MIN|MAX}]  
[SENSe:]PERiod:APERture {<seconds>|MIN|MAX}{,(@<ch\_list>)}  
[SENSe:]PERiod:APERture? [{(@<ch\_list>)|MIN|MAX}]

**Description** Set or query the gate time (also called aperture time) of the frequency or period measurements on the specified channels.

### Parameters

Name	Type	Range	Default
<seconds>	Numeric	Any numeric value between MIN and MAX. The final gate time is decided by the " <b>Principle of setting with greater value</b> ". The standard values of the gate time: {1ms 10ms 100ms 1s} Wherein: MIN=1ms, MAX=1s.	100ms
<ch_list>	Channel List	One or more channels (only for the multiplexer channels), the rules are as follows: (@101): channel 01 on the module in Slot1; (@101:103): channel 01 through 03 on the module in Slot1; (@101:103,301): channel 01 through 03 on the module in Slot1 and channel 01 on the module in Slot3;	If the parameter is omitted, this command will be applied to the whole scan list.

- Explanation**
- Before using this command, please configure the specified channels to frequency or period measurement function. Otherwise, an error will be generated.
  - If <ch\_list> is omitted, the command will be applied to the whole scan list. At this point, make sure that all the channels in the scan list are configured to frequency or period measurement function. Otherwise, an error will be generated.
  - You can use MIN or MAX to set <seconds>.
  - In the aperture time mode, the instrument selects the minimum resolution (namely,  $0.03\text{ppm} \times \text{<range>}$ ).

- The instrument sets the gate time to 100 ms after a Factory Reset (send the [\\*RST](#) command). An Instrument Preset (send the [SYSTem:PRESet](#) command) or Card Reset (send the [SYSTem:CPON](#) command) does not affect the current gate time.

**Return Format** The query returns the gate time in scientific notation for each channel specified. Multiple return values are separated by commas.

**Example** `FREQ:APER 10E-01,(@203,205)`  
`FREQ:APER? (@203,205)`

The query returns `+1.00000000E+00,+1.00000000E+00`.

You can replace FREQ with PER to set or query the gate time of the period measurements of the specified channels.

**Related commands** [SENSe Command Subsystem](#)  
[CONFigure:FREQuency](#)  
[MEASure:FREQuency?](#)  
[CONFigure:PERiod](#)  
[MEASure:PERiod?](#)  
[\[SENSe:\]FUNctioN](#)

## [SENSe:]FREQuency:RANGe:LOWer [SENSe:]PERiod:RANGe:LOWer

**Syntax** `[SENSe:]FREQuency:RANGe:LOWer {<filter>|MIN|MAX}[,(@<ch_list>)]`  
`[SENSe:]FREQuency:RANGe:LOWer? [,{(@<ch_list>)|MIN|MAX}]`  
`[SENSe:]PERiod:RANGe:LOWer {<filter>|MIN|MAX}[,(@<ch_list>)]`  
`[SENSe:]PERiod:RANGe:LOWer? [,{(@<ch_list>)|MIN|MAX}]`

**Description** Set or query the AC filter parameter of the frequency or period measurements on the specified channels.

Parameters	Name	Type	Range	Default
	<filter>	Numeric	Any integer between MIN and 1000000. The final AC filter is decided by the <b>"Principle of setting with smaller value"</b> . The standard values of the range: {3 20 200} Wherein: MIN=3Hz, MAX=200Hz.	20Hz
	<ch_list>	Channel List	One or more channels (only for the multiplexer channels), the rules are as follows: (@101): channel 01 on the module in Slot1; (@101:103): channel 01 through 03 on the module in Slot1; (@101:103,301): channel 01 through 03 on the module in Slot1 and channel 01 on the module in Slot3.	If the parameter is omitted, this command will be applied to the whole scan list.

**Explanation** ➤ Before using this command, please configure the specified channels to frequency or period measurement function. Otherwise, an error will be generated.

➤ If <ch\_list> is omitted, the command will be applied to the whole scan list. At this

point, make sure that all the channels in the scan list are configured to frequency or period measurement function. Otherwise, an error will be generated.

- <filter> cannot be a decimal number. Otherwise, an error will be generated.
- The [CONFigure:FREQuency \(CONFigure:PERiod\)](#) or [MEASure:FREQuency? \(MEASure:PERiod?\)](#) command automatically selects the 20 Hz AC filter.
- During the measurement, the filter type is determined by the frequency of the input signal of the current channel as shown in the table below.

Input Frequency	AC Filter Type
3 Hz to 300 kHz	3 Hz (slow)
20 Hz to 300 kHz	20 Hz (medium)
200 Hz to 300 kHz	200 Hz (fast)

- The instrument selects the 20 Hz AC filter after a Factory Reset (send the [\\*RST](#) command). An Instrument Preset (send the [SYSTem:PRESet](#) command) or Card Reset (send the [SYSTem:CPON](#) command) does not affect the current AC filter parameter.

**Return Format** The query returns the AC filter parameter in scientific notation for each channel specified. Multiple return values are separated by commas.

**Example** `FREQ:RANG:LOW 200,(@301)`  
`FREQ:RANG:LOW? (@301)`  
 The query returns 2.000000000E+02.  
 You can replace FREQ with PER to set or query the AC filter parameter of the period measurements on the specified channels.

**Related commands** [SENSe Command Subsystem](#)  
[\[SENSe:\]FUNctioN](#)

## [SENSe:]FREQuency:VOLTage:RANGe

## [SENSe:]PERiod:VOLTage:RANGe

**Syntax** `[SENSe:]FREQuency:VOLTage:RANGe {<range>|MIN|MAX}[,(@<ch_list>)]`  
`[SENSe:]FREQuency:VOLTage:RANGe? [{{(@<ch_list>)|MIN|MAX}]`  
`[SENSe:]PERiod:VOLTage:RANGe {<range>|MIN|MAX}[,(@<ch_list>)]`  
`[SENSe:]PERiod:VOLTage:RANGe? [{{(@<ch_list>)|MIN|MAX}]`

**Description** Set or query the voltage ranges of the frequency or period measurements on the specified channels.

Parameters	Name	Type	Range	Default
	<range>	Discrete	Any numeric value between 0 and 110*MAX. The final range is decided by the " <b>Principle of setting with greater value</b> " when <range> is between 0 and MAX; the final range is MAX when <range> is greater than MAX.  The standard values of the range are {200mV 2V 20V 200V 300V MIN MAX}; wherein, MIN=200mV, MAX=300V.	Auto
	<ch_list>	Channel List	One or more channels (only for the multiplexer channels), the rules are as follows: (@101): channel 01 on the module in Slot1; (@101:103): channel 01 through 03 on the	If the parameter is omitted, this command will be applied to the whole scan

	module in Slot1; (@101:103,301): channel 01 through 03 on the module in Slot1 and channel 01 on the module in Slot3.	list.
--	---	-------

- Explanation**
- Before using this command, please configure the specified channels to frequency or period measurement function. Otherwise, an error will be generated.
  - If <ch\_list> is omitted, the command will be applied to the whole scan list. At this point, make sure that all the channels in the scan list are configured to frequency or period measurement function. Otherwise, an error will be generated.
  - Selecting a specific range will disable the autoranging on the specified channels.
  - The [CONFigure:FREQuency \(CONFigure:PERiod\)](#) or [MEASure:FREQuency? \(MEASure:PERiod?\)](#) command automatically enables the autoranging if the first parameter is AUTO, DEF or omitted.
  - The instrument selects autoranging after a Factory Reset (send the [\\*RST](#) command). An Instrument Preset (send the [SYSTem:PRESet](#) command) or Card Reset (send the [SYSTem:CPON](#) command) does not affect the current range setting.

**Return Format** The query returns the voltage range in scientific notation for each channel specified. Multiple return values are separated by commas.

**Example** `FREQ:VOLT:RANG 20,(@301)`  
`FREQ:VOLT:RANG? (@301)`

The query returns +2.00000000E+01.

You can replace FREQ with PER to set or query the voltage ranges of the period measurements on the specified channels.

**Related commands** [SENSe Command Subsystem](#)  
[\[SENSe:\]FREQuency:VOLTage:RANGe:AUTO](#)  
[\[SENSe:\]PERiod:VOLTage:RANGe:AUTO](#)  
[\[SENSe:\]FUNCTion](#)

## **[SENSe:]FREQuency:VOLTage:RANGe:AUTO**

## **[SENSe:]PERiod:VOLTage:RANGe:AUTO**

**Syntax** `[SENSe:]FREQuency:VOLTage:RANGe:AUTO <state>[,(@<ch_list>)]`  
`[SENSe:]FREQuency:VOLTage:RANGe:AUTO? [(@<ch_list>)]`  
`[SENSe:]PERiod:VOLTage:RANGe:AUTO <state>[,(@<ch_list>)]`  
`[SENSe:]PERiod:VOLTage:RANGe:AUTO? [(@<ch_list>)]`

**Description** Disable or enable the autoranging of the frequency or period measurements on the specified channels.

Parameters	Name	Type	Range	Default
	<state>	Bool	{OFF 0 ON 1}	ON
	<ch_list>	Channel List	One or more channels (only for the multiplexer channels), the rules are as follows: (@101): channel 01 on the module in Slot1; (@101:103): channel 01 through 03 on the module in Slot1; (@101:103,301): channel 01 through 03 on	If the parameter is omitted, this command will be applied to the whole scan list.

		the module in Slot1 and channel 01 on the module in Slot3.	
--	--	--	--

- Explanation**
- Before using this command, please configure the specified channels to frequency or period measurement function. Otherwise, an error will be generated.
  - If <ch\_list> is omitted, the command will be applied to the whole scan list. At this point, make sure that all the channels in the scan list are configured to frequency or period measurement function. Otherwise, an error will be generated.
  - Autoranging rule: for signals under test that is between 10%\*Range and 110%\*Range, the instrument automatically selects Range as the current range.
  - Selecting a specific range for the specified channel will disable the autoranging (send the [\[SENSe:\]FREQuency:VOLTage:RANGe](#) or [\[SENSe:\]PERiod:VOLTage:RANGe](#) command).
  - The [CONFigure:FREQuency](#) ([CONFigure:PERiod](#)) or [MEASure:FREQuency?](#) ([MEASure:PERiod?](#)) command automatically enables the autoranging if the first parameter is AUTO, DEF or omitted.
  - The instrument selects autoranging after a Factory Reset (send the [\\*RST](#) command). An Instrument Preset (send the [SYSTem:PRESet](#) command) or Card Reset (send the [SYSTem:CPON](#) command) does not affect the current range setting.

**Return Format** The query returns 0 (OFF) or 1 (ON). Multiple return values are separated by commas.

**Example** `FREQ:VOLT:RANG:AUTO OFF,(@301:302)`  
`FREQ:VOLT:RANG:AUTO? (@301:302)`

The query returns 0,0.  
 You can replace FREQ with PER to enable the autoranging of the period measurements on the specified channels.

**Related commands** [SENSe Command Subsystem](#)  
[\[SENSe:\]FUNctioN](#)

## [SENSe:]FUNctioN

**Syntax** `[SENSe:]FUNctioN "<function>"[(,@<ch_list>)]`  
`[SENSe:]FUNctioN? [(,@<ch_list>)]`

**Description** Set or query the measurement functions of the specified channels.

Parameters	Name	Type	Range	Default
	<function>	Discrete	{TEMPerature VOLTage[:DC] VOLTage:AC CURRent[:DC] CURRent:AC FREQuency PERiod SENSOR}	None
	<ch_list>	Channel List	One or more channels (only for the multiplexer channels) the rules are as follows: (@101): channel 01 on the module in Slot1; (@101:103): channel 01 through 03 on the module in Slot1; (@101:103,301): channel 01 through 03 on the module in Slot1 and channel 01 on the module in Slot3.	If the parameter is omitted, this command will be applied to the whole scan list.

**Explanation** ➤ This command is not available for the multifunction module.

- The query returns the measurement functions of the specified channels. If <ch\_list> is omitted, the query returns the measurement functions of all the multiplexer channels in the scan list. At this point, if the scan list is empty, an error will occur.
- No matter whether the specified channels are added into the scan list or not, sending this command will change the measurement functions of the specified channels.
- When you change the measurement function of a channel, all the measurement parameters are set to their default values.
- You cannot set any function-specific measurement parameters using the SENSE commands unless the channel is already configured for that function. For example, you cannot set the AC filter parameter unless that channel is already configured for the ACV, ACI, frequency or period measurement function.

**Return Format** The query returns the abbreviation of the measurement function (enclosed in double quotation marks) on each channel. Multiple return values are separated by commas.

**Example**

```
FUNC "TEMP",(@301)
FUNC "VOLT:AC",(@102)
FUNC "VOLT",(@103)
FUNC "CURR",(@121)
FUNC? (@121,301,102:104)
```

The query returns "CURR", "TEMP", "VOLT:AC", "VOLT".

**Related command** [SENSe Command Subsystem](#)

## [SENSe:]TEMPerature:APERture

**Syntax** [SENSe:]TEMPerature:APERture {<seconds>|MIN|MAX}[,(@<ch\_list>)]  
 [SENSe:]TEMPerature:APERture? [ {( @<ch\_list> )|MIN|MAX} ]

**Description** Set or query the integration time via the aperture time mode for the temperature measurements on the specified channels.

**Parameters**

Name	Type	Range	Default
<seconds>	Numeric	Any numeric value between MIN and MAX. MIN=33 $\mu$ s, MAX=4 s.	None
<ch_list>	Channel List	One or more channels (only for the multiplexer channels), the rules are as follows:  (@101): channel 01 on the module in Slot1; (@101:103): channel 01 through 03 on the module in Slot1; (@101:103,301): channel 01 through 03 on the module in Slot1 and channel 01 on the module in Slot3.	If the parameter is omitted, this command will be applied to the whole scan list.

- Explanation**
- Before using this command, please configure the specified channels to temperature measurement function. Otherwise, an error will be generated.
  - If <ch\_list> is omitted, the command will be applied to the whole scan list. At this point, make sure that all the channels in the scan list are configured to temperature measurement function. Otherwise, an error will be generated.
  - You can use MIN or MAX to set <time>.
  - In the aperture time mode, the instrument selects the minimum resolution (namely,

0.03ppm× <range>).

- The [CONFigure:TEMPerature](#) , [MEASure:TEMPerature?](#) or [\[SENSe:\]TEMPerature:NPLC](#) command automatically disables the aperture time mode and enables the power line cycles mode.
- The aperture time mode is disabled after a Factory Reset (send the [\\*RST](#) command). An Instrument Preset (send the [SYSTem:PRESet](#) command) or Card Reset (send the [SYSTem:CPON](#) command) does not affect the current integration time parameter.

**Return Format** The query returns the integration time in scientific notation for each channel specified. Multiple return values are separated by commas.

**Example** TEMP:APER 0.02,(@101)  
 TEMP:APER? (@101)  
 The query returns +2.00000000E-02.

**Related command** [SENSe Command Subsystem](#)

## [SENSe:]TEMPerature:NPLC

**Syntax** [SENSe:]TEMPerature:NPLC {<PLCs>|MIN|MAX}[,(@<ch\_list>)]  
 [SENSe:]TEMPerature:NPLC? [ {( @<ch\_list> )|MIN|MAX} ]

**Description** Set or query the integration time via the power line cycles mode for the temperature measurements on the specified channels.

Parameters	Name	Type	Range	Default
	<PLCs>	Numeric	Any numeric value between MIN and MAX. The final integration time is decided by the " <b>Principle of setting with greater value</b> ". The standard values of the range: {0.02 0.2 1 2 10 20 100 200} Wherein: MIN=0.02PLC, MAX=200PLC.	1PLC
	<ch_list>	Channel List	One or more channels (only for the multiplexer channels), the rules are as follows: (@101): channel 01 on the module in Slot1; (@101:103): channel 01 through 03 on the module in Slot1; (@101:103,301): channel 01 through 03 on the module in Slot1 and channel 01 on the module in Slot3.	If the parameter is omitted, this command will be applied to the whole scan list.

- Explanation**
- Before using this command, please configure the specified channels to temperature measurement function. Otherwise, an error will be generated.
  - If <ch\_list> is omitted, the command will be applied to the whole scan list. At this point, make sure that all the channels in the scan list are configured to temperature measurement function. Otherwise, an error will be generated.
  - The longer the integration time is, the slower the measurement speed and the better the measurement resolution will be; the shorter the integration time is, the faster the measurement speed and the lower the measurement resolution will be.
  - You can also set the integration time via the aperture time mode (send the [\[SENSe:\]TEMPerature:APERture](#) command).
  - The instrument sets the integration time to 1 PLC after a Factory Reset (send the [\\*RST](#)

command). An Instrument Preset (send the [SYSTem:PRESet](#) command) or Card Reset (send the [SYSTem:CPON](#) command) does not affect the current integration time parameter.

**Return Format** The query returns the integration time in scientific notation for each channel specified. Multiple return values are separated by commas.

**Example** TEMP:NPLC 10,(@101,102)  
TEMP:NPLC? (@101,102)

The query returns +1.00000000E+01,+1.00000000E+01.

**Related commands** [SENSe Command Subsystem](#)  
[CONFigure:TEMPerature](#)  
[MEASure:TEMPerature?](#)

## [SENSe:]TEMPerature:RJUNction?

**Syntax** [SENSe:]TEMPerature:RJUNction? [(@<ch\_list>)]

**Description** Query the temperatures of the internal reference sources of the specified channels.

**Parameters**

Name	Type	Range	Default
<ch_list>	Channel List	One or more channels (only for the multiplexer channels), the rules are as follows: (@101): channel 01 on the module in Slot1; (@101:103): channel 01 through 03 on the module in Slot1; (@101:103,301): channel 01 through 03 on the module in Slot1 and channel 01 on the module in Slot3.	If the parameter is omitted, this command will be applied to the whole scan list.

**Explanation** This query returns the reference temperature in degrees Celsius, regardless of the temperature unit currently selected using the [UNIT:TEMPerature](#) command.

**Return Format** The query returns the internal reference source temperature in scientific notation for each channel specified. Multiple return values are separated by commas.

**Example** TEMP:RJUN? (@101,102)

The query returns +2.35212231E+01,+2.35212231E+01.

**Related command** [SENSe Command Subsystem](#)

## [SENSe:]TEMP:TRANsducer:FRTD:OCOMpensated [SENSe:]TEMP:TRANsducer:RTD:OCOMpensated

**Syntax** [SENSe:]TEMP:TRANsducer:FRTD:OCOMpensated <mode> [,(@<ch\_list>)]  
[SENSe:]TEMP:TRANsducer:FRTD:OCOMpensated? [(@<ch\_list>)]  
[SENSe:]TEMP:TRANsducer:RTD:OCOMpensated <mode> [,(@<ch\_list>)]  
[SENSe:]TEMP:TRANsducer:RTD:OCOMpensated? [(@<ch\_list>)]

**Description** Enable or disable the offset compensation function for the 2-wire or 4-wire thermal resistance temperature measurements on the specified channels.

**Parameters**

Name	Type	Range	Default
------	------	-------	---------



<mode>	Bool	{OFF 0 ON 1}	OFF
<ch_list>	Channel List	<p>One or more channels (only for the multiplexer channels), the rules are as follows:</p> <p>(@101): channel 01 on the module in Slot1;            (@101:103): channel 01 through 03 on the module in Slot1;            (@101:103,301): channel 01 through 03 on the module in Slot1 and channel 01 on the module in Slot3.</p>	If the parameter is omitted, this command will be applied to the whole scan list.

- Explanation**
- Before using this command, please configure the specified channels to temperature measurement function and the temperature sensor type is RTD 4W or RTD. Otherwise, an error will be generated.
  - If <ch\_list> is omitted, the command will be applied to the whole scan list. At this point, make sure that all the channels in the scan list are configured to temperature measurement function and the temperature sensor type is RTD 4W or RTD. Otherwise, an error will be generated.
  - MC3164 does not support the 4-wire thermal resistance temperature measurement function.
  - The offset compensation removes the effects of any DC offset of the measurement lead on the measurement results.
  - For the 4-wire thermal resistance temperature measurement function, channel n is paired with channel n+16 (for MC3132, the range of n is from 1 to 16) or n+10 (for MC3324, MC3120 and MC3120A, the range of n is from 1 to 10) automatically. Channel n is used to connect the source terminal of the DMM and channel n+16 or channel n+10 is used to connect the sense terminal of the DMM. The paired channels cannot be configured.
  - The [CONFigure:TEMPerature](#) or [MEASure:TEMPerature?](#) command automatically disable the offset compensation.
  - The instrument disables the offset compensation after a Factory Reset (send the [\\*RST](#) command). An Instrument Preset (send the [SYSTem:PRESet](#) command) or Card Reset (send the [SYSTem:CPON](#) command) does not affect the current status of the offset compensation.

**Return Format** The query returns 1(ON) or 0(OFF). Multiple return values are separated by commas.

**Example** TEMP:TRAN:FRTD:OCOM ON,(@201:202)  
 TEMP:TRAN:FRTD:OCOM? (@201:202)

The query returns 1,1.

You can replace FRTD with RTD to enable or disable the offset compensation function for the 2-wire thermal resistance temperature measurements on the specified channels.

**Related command** [SENSe Command Subsystem](#)

**[SENSe:]TEMPerature:TRANsdUcer:FRTD:RESistance[:REFerence]**  
**[SENSe:]TEMPerature:TRANsdUcer:RTD:RESistance[:REFerence]**

**Syntax** [SENSe:]TEMPerature:TRANsdUcer:FRTD:RESistance[:REFerence]  
 <reference>[,(@<ch\_list>)]

```
[SENSe:]TEMPerature:TRANsducer:FRTD:RESistance[:REFerence]? [(@<ch_list>)]
```

```
[SENSe:]TEMPerature:TRANsducer:RTD:RESistance[:REFerence]
<reference>[,(@<ch_list>)]
```

```
[SENSe:]TEMPerature:TRANsducer:RTD:RESistance[:REFerence]? [(@<ch_list>)]
```

**Description** Set or query the rated resistance (R0) of the 2-wire or 4-wire thermal resistance temperature measurements on the specified channels.

**Parameters**

Name	Type	Range	Default
<reference>	Numeric	Any numeric value between 49Ω and 2100Ω	100Ω
<ch_list>	Channel List	One or more channels (only for the multiplexer channels), the rules are as follows: (@101): channel 01 on the module in Slot1; (@101:103): channel 01 through 03 on the module in Slot1; (@101:103,301): channel 01 through 03 on the module in Slot1 and channel 01 on the module in Slot3.	If the parameter is omitted, this command will be applied to the whole scan list.

**Explanation**

- Before using this command, please configure the specified channels to temperature measurement function and the temperature sensor type is RTD 4W or RTD. Otherwise, an error will be generated.
- If <ch\_list> is omitted, the command will be applied to the whole scan list. At this point, make sure that all the channels in the scan list are configured to temperature measurement function and the temperature sensor type is RTD 4W or RTD. Otherwise, an error will be generated.
- MC3164 does not support the 4-wire thermal resistance temperature measurement function.
- For the 4-wire thermal resistance temperature measurement function, channel n is paired with channel n+16 (for MC3132, the range of n is from 1 to 16) or n+10 (for MC3324, MC3120 and MC3120A, the range of n is from 1 to 10) automatically. Channel n is used to connect the source terminal of the DMM and channel n+16 or channel n+10 is used to connect the sense terminal of the DMM. The paired channels cannot be configured.
- The instrument sets the rated resistance to 100Ω after a Factory Reset (send the [\\*RST](#) command). An Instrument Preset (send the [SYSTem:PRESet](#) command) or Card Reset (send the [SYSTem:CPON](#) command) does not affect the current rated resistance.

**Return Format**

The query returns the rated resistance in scientific notation for each channel specified. Multiple return values are separated by commas.

**Example**

```
TEMP:TRAN:RTD:RES:REF 50,(@301,302)
TEMP:TRAN:RTD:RES:REF? (@301,302)
```

The query returns +5.000000E+01,+5.000000E+01.

You can replace FRTD with RTD to set or query the rated resistance (R0) of the 2-wire thermal resistance temperature measurements on the specified channels..

**Related command**

[SENSe Command Subsystem](#)

**[SENSe:]TEMPerature:TRANsducer:FRTD:TYPE****[SENSe:]TEMPerature:TRANsducer:RTD:TYPE**

**Syntax** [SENSe:]TEMPerature:TRANsducer:FRTD:TYPE <type>[,(@<ch\_list>)]  
 [SENSe:]TEMPerature:TRANsducer:FRTD:TYPE? [(@<ch\_list>)]  
 [SENSe:]TEMPerature:TRANsducer:RTD:TYPE <type>[,(@<ch\_list>)]  
 [SENSe:]TEMPerature:TRANsducer:RTD:TYPE? [(@<ch\_list>)]

**Description** Set or query the thermal resistance type of the 2-wire or 4-wire thermal resistance temperature measurements on the specified channels.

**Parameters**

Name	Type	Range	Default
<type>	Discrete	{85 89 91 92}	85
<ch_list>	Channel List	One or more channels (only for the multiplexer channels), the rules are as follows: (@101): channel 01 on the module in Slot1; (@101:103): channel 01 through 03 on the module in Slot1; (@101:103,301): channel 01 through 03 on the module in Slot1 and channel 01 on the module in Slot3.	If the parameter is omitted, this command will be applied to the whole scan list.

- Explanation**
- Before using this command, please configure the specified channels to temperature measurement function and the temperature sensor type is RTD 4W or RTD. Otherwise, an error will be generated.
  - If <ch\_list> is omitted, the command will be applied to the whole scan list. At this point, make sure that all the channels in the scan list are configured to temperature measurement function and the temperature sensor type is RTD 4W or RTD. Otherwise, an error will be generated.
  - MC3164 does not support the 4-wire thermal resistance temperature measurement function.
  - For the 4-wire thermal resistance temperature measurement function, channel n is paired with channel n+16 (for MC3132, the range of n is from 1 to 16) or n+10 (for MC3324 and MC3120, the range of n is from 1 to 10) automatically. Channel n is used to connect the source terminal of the DMM and channel n+16 or channel n+10 is used to connect the sense terminal of the DMM. The paired channels cannot be configured.
  - The instrument sets the rated resistance to 100Ω after a Factory Reset (send the [\\*RST](#) command). An Instrument Preset (send the [SYSTem:PRESet](#) command) or Card Reset (send the [SYSTem:CPON](#) command) does not affect the current rated resistance.

**Return Format** The query returns the thermal resistance type of each channel specified. Multiple return values are separated by commas.

**Example** TEMP:TRAN:RTD:TYPE 92,(@101:103)  
 TEMP:TRAN:RTD:TYPE? (@101:104)

The query returns +92,+92,+92,+85.

You can replace FRTD with RTD to set or query the thermal resistance type of the 2-wire thermal resistance temperature measurements on the specified channels.

**Related command** [SENSe Command Subsystem](#)

## [SENSE:]TEMPerature:TRANsducer:TCouple:CHECK

**Syntax** [SENSE:]TEMPerature:TRANsducer:TCouple:CHECK <state>[,(@<ch\_list>)]

[SENSE:]TEMPerature:TRANsducer:TCouple:CHECK? [(@<ch\_list>)]

**Description** Disable or enable the T/C check function (check whether the thermocouples are properly connected) of the thermocouple measurements on the specified channels.

Parameters	Name	Type	Range	Default
	<state>	Bool	{OFF 0 ON 1}	OFF
	<ch_list>	Channel List	One or more channels (only for the multiplexer channels), the rules are as follows: (@101): channel 01 on the module in Slot1; (@101:103): channel 01 through 03 on the module in Slot1; (@101:103,301): channel 01 through 03 on the module in Slot1 and channel 01 on the module in Slot3.	If the parameter is omitted, this command will be applied to the whole scan list.

- Explanation**
- Before using this command, please configure the specified channels to temperature measurement function and the temperature sensor type is TC. Otherwise, an error will be generated.
  - If <ch\_list> is omitted, the command will be applied to the whole scan list. At this point, make sure that all the channels in the scan list are configured to temperature measurement function and the temperature sensor type is TC. Otherwise, an error will be generated.
  - When the function is enabled, the instrument measures the channel resistance (the range is 20 kΩ) to check whether the thermocouple is correctly connected automatically before each measurement. The instrument prompts and displays "OPEN T/C" if an open connection is detected (the channel resistance measured is greater than 5kΩ).
  - The instrument disables the T/C check function (check whether the thermocouples are properly connected) after a Factory Reset (send the [\\*RST](#) command). An Instrument Preset (send the [SYSTEM:PRESet](#) command) or Card Reset (send the [SYSTEM:CPON](#) command) does not affect the status of the T/C check function.

**Return Format** The query returns 0 (OFF) or 1 (ON). Multiple return values are separated by commas.

**Example** TEMP:TRAN:TC:CHEC ON,(@101:103)  
TEMP:TRAN:TC:CHEC? (@101:103,205)

The query returns 1,1,1,0.

**Related command** [SENSE Command Subsystem](#)

## [SENSE:]TEMPerature:TRANsducer:TCouple:RJUNction:TYPE

**Syntax** [SENSE:]TEMPerature:TRANsducer:TCouple:RJUNction:TYPE <type>[,(@<ch\_list>)]

[SENSE:]TEMPerature:TRANsducer:TCouple:RJUNction:TYPE? [(@<ch\_list>)]

**Description** Set or query the reference source type of the thermocouple temperature measurements on the specified channels.

Parameters	Name	Type	Range	Default
------------	------	------	-------	---------

<type>	Discrete	{INTernal EXTernal FIXed}	INTernal
<ch_list>	Channel List	<p>One or more channels (only for the multiplexer channels), the rules are as follows:</p> <p>(@101):channel 01 on the module in Slot1;            (@101:103):channel 01 through 03 on the module in Slot1;            (@101:103,301):channel 01 through 03 on the module in Slot1 and channel 01 on the module in Slot3.</p>	If the parameter is omitted, this command will be applied to the whole scan list.

- Explanation**
- Before using this command, please configure the specified channels to temperature measurement function and the temperature sensor type is TC. Otherwise, an error will be generated.
  - If <ch\_list> is omitted, the command will be applied to the whole scan list. At this point, make sure that all the channels in the scan list are configured to temperature measurement function and the temperature sensor type is TC. Otherwise, an error will be generated.
  - The thermocouple measurements require a reference junction temperature. For the reference junction temperature, you can select the internal reference source (acquire the temperature of the module wiring terminal), the external reference source (acquire the temperature of the thermistor or thermal resistor) or a known temperature.
  - When the reference source type is set to FIXed, you can specify a value between -20 °C and +80 °C using the [\[SENSe:\]TEMPerature:TRANsducer:TCouple:RJUNction](#) command. You must always specify the temperature in degrees Celsius regardless of the temperature unit currently selected using the [UNIT:TEMPerature](#) command.
  - Before selecting external reference source, please find the first module which supports the temperature measurement function starting from Slot1. Then configure the first channel of this module to a temperature measurement function (THER, RTD or RTD 4W). Otherwise, you can not select external reference for other channels. This channel is then reserved as the reference channel. At this point, you can select external reference sources for other channels. If this channel is deleted or its function is modified, the channels taking this channel as the reference source will revert to the internal reference automatically.
  - When the thermocouple reference source is set to EXTernal and the measurement of this reference source is initialized, the thermocouple measurements use the measurement value of this reference source as the reference source temperature and the reference source temperatures of other thermocouple channels all refer to the measurement value of this reference source.
  - The instrument selects the internal reference source after a Factory Reset (send the [\\*RST](#) command). An Instrument Preset (send the [SYSTem:PRESet](#) command) or Card Reset (send the [SYSTem:CPON](#) command) does not affect the current reference source setting.

**Return Format** The query returns INT (internal), EXT (external) or FIX (fixed) for each channel specified. Multiple return values are separated by commas.

**Example** TEMP:TRAN:TC:RJUN:TYPE FIX,(@101:103)  
 TEMP:TRAN:TC:RJUN:TYPE? (@101:103,205)

The query returns FIX, FIX, FIX, INT.

**Related command** [SENSe Command Subsystem](#)

## [SENSe:]TEMPerature:TRANsducer:TCouple:RJUNction

**Syntax** [SENSe:]TEMPerature:TRANsducer:TCouple:RJUNction  
{<temperature>|MIN|MAX}{,(@<ch\_list>)}

[SENSe:]TEMPerature:TRANsducer:TCouple:RJUNction? [MIN|MAX]{,(@<ch\_list>)}

**Description** Set or query the reference junction temperature of the thermocouple temperature measurements (fixed reference source) on the specified channels.

Parameters	Name	Type	Range	Default
	<temperature>	Numeric	Any numeric number between -20°C to +80°C	0°C
	<ch_list>	Channel List	One or more channels (only for the multiplexer channels), the rules are as follows: (@101): channel 01 on the module in Slot1; (@101:103): channel 01 through 03 on the module in Slot1; (@101:103,301): channel 01 through 03 on the module in Slot1 and channel 01 on the module in Slot3.	If the parameter is omitted, this command will be applied to the whole scan list.

- Explanation**
- Before using this command, please configure the specified channels to temperature measurement function and the temperature sensor type is TC. Otherwise, an error will be generated.
  - If <ch\_list> is omitted, the command will be applied to the whole scan list. At this point, make sure that all the channels in the scan list are configured to temperature measurement function and the temperature sensor type is TC. Otherwise, an error will be generated.
  - For this command, you must always specify the temperature in degrees Celsius regardless of the temperature unit currently selected using the [UNIT:TEMPerature](#) command.
  - The instrument sets the reference junction temperature of the fixed reference source to 0 °C after a Factory Reset (send the [\\*RST](#) command). An Instrument Preset (send the [SYSTEM:PRESet](#) command) or Card Reset (send the [SYSTEM:CPON](#) command) does not affect the current reference junction temperature setting.

**Return Format** The query returns the reference junction temperature of the fixed reference source in scientific notation for each channel specified in degrees Celsius. Multiple return values are separated by commas.

**Example** TEMP:TRAN:TC:RJUN 25.2,(@301:303)  
TEMP:TRAN:TC:RJUN? (@301:303)

The query returns 2.520000000E+01,2.520000000E+01,2.520000000E+01.

**Related commands** [SENSe Command Subsystem](#)

[\[SENSe:\]TEMPerature:TRANsducer:TCouple:RJUNction:TYPE](#)

## [SENSe:]TEMPerature:TRANsducer:TCouple:TYPE

**Syntax** [SENSe:]TEMPerature:TRANsducer:TCouple:TYPE <type>{,(@<ch\_list>)}

[SENSe:]TEMPerature:TRANsducer:TCouple:TYPE? [{,(@<ch\_list>)}]

**Description** Set or query the thermocouple type of the thermocouple temperature measurements on

the specified channels.

Parameters	Name	Type	Range	Default
	<type>	Discrete	{B E J K N R S T}	J
	<ch_list>	Channel List	One or more channels (only for the multiplexer channels), the rules are as follows: (@101): channel 01 on the module in Slot1; (@101:103): channel 01 through 03 on the module in Slot1; (@101:103,301): channel 01 through 03 on the module in Slot1 and channel 01 on the module in Slot3.	If the parameter is omitted, this command will be applied to the whole scan list.

- Explanation**
- Before using this command, please configure the specified channels to temperature measurement function and the temperature sensor type is TC. Otherwise, an error will be generated.
  - If <ch\_list> is omitted, the command will be applied to the whole scan list. At this point, make sure that all the channels in the scan list are configured to temperature measurement function and the temperature sensor type is TC. Otherwise, an error will be generated.
  - The instrument sets the thermocouple type to "J" after a Factory Reset (send the [\\*RST](#) command). An Instrument Preset (send the [SYSTem:PRESet](#) command) or Card Reset (send the [SYSTem:CPON](#) command) does not affect the current thermocouple type.

**Return Format** The query returns the thermocouple type for each channel specified. Multiple return values are separated by commas.

**Example** TEMP:TRAN:TC:TYPE K,(@101:103)  
TEMP:TRAN:TC:TYPE? (@101:103,205)

The query returns K,K,K,J.

**Related command** [SENSe Command Subsystem](#)

## [SENSe:]TEMPerature:TRANsdruer:THERmistor:TYPE

**Syntax** [SENSe:]TEMPerature:TRANsdruer:THERmistor:TYPE <type>[,(@<ch\_list>)]

[SENSe:]TEMPerature:TRANsdruer:THERmistor:TYPE? [(@<ch\_list>)]

**Description** Set or query the thermistor type of the thermistor temperature measurements on the specified channels.

Parameters	Name	Type	Range	Default
	<type>	Discrete	{2252 3000 5000 10000 30000}	5000
	<ch_list>	Channel List	One or more channels (only for the multiplexer channels), the rules are as follows: (@101): channel 01 on the module in Slot1; (@101:103): channel 01 through 03 on the module in Slot1; (@101:103,301): channel 01 through 03 on the module in Slot1 and channel 01 on the module in Slot3.	If the parameter is omitted, this command will be applied to the whole scan list.

- Explanation**
- Before using this command, please configure the specified channels to temperature measurement function and the temperature sensor type is THER. Otherwise, an error will be generated.
  - If <ch\_list> is omitted, the command will be applied to the whole scan list. At this point, make sure that all the channels in the scan list are configured to temperature measurement function and the temperature sensor type is THER. Otherwise, an error will be generated.
  - The instrument sets the thermistor type to "5000" after a Factory Reset (send the [\\*RST](#) command). An Instrument Preset (send the [SYSTem:PRESet](#) command) or Card Reset (send the [SYSTem:CPON](#) command) does not affect the current thermistor type.

**Return Format** The query returns the thermistor type for each channel specified. Multiple return values are separated by commas.

**Example** TEMP:TRAN:THER:TYPE 2252,(@101:103)  
TEMP:TRAN:THER:TYPE? (@101:103,205)

The query returns +2252,+2252,+2252,+5000.

**Related command** [SENSe Command Subsystem](#)

## [SENSe:]TEMPerature:TRANsducer:TYPE

**Syntax** [SENSe:]TEMPerature:TRANsducer:TYPE  
{TCouple|RTD|FRTD|THERmistor|DEF}[,(@<ch\_list>)]  
[SENSe:]TEMPerature:TRANsducer:TYPE? [(@<ch\_list>)]

**Description** Set or query the sensor type of the temperature measurements on the specified channels.

**Parameters**

Name	Type	Range	Default
TYPE	Discrete	{TCouple FRTD THERmistor DEF} DEF=TCouple	TCouple
<ch_list>	Channel List	One or more channels (only for the multiplexer channels), the rules are as follows: (@101): channel 01 on the module in Slot1; (@101:103): channel 01 through 03 on the module in Slot1; (@101:103,301): channel 01 through 03 on the module in Slot1 and channel 01 on the module in Slot3.	If the parameter is omitted, this command will be applied to the whole scan list.

- Explanation**
- Before using this command, please configure the specified channels to temperature measurement function. Otherwise, an error will be generated.
  - If <ch\_list> is omitted, the command will be applied to the whole scan list. At this point, make sure that all the channels in the scan list are configured to temperature measurement function. Otherwise, an error will be generated.
  - MC3164 does not support the 4-wire thermal resistance temperature measurement function.
  - For the 4-wire thermal resistance temperature measurement function, channel n is paired with channel n+16 (for MC3132, the range of n is from 1 to 16) or n+10 (for MC3324 and MC3120, the range of n is from 1 to 10) automatically. Channel n is used to connect the source terminal of the DMM and channel n+16 or channel n+10 is used



to connect the sense terminal of the DMM. The paired channels cannot be configured.

- The instrument selects TCouple as the sensor type after a Factory Reset (send the [\\*RST](#) command). An Instrument Preset (send the [SYSTem:PRESet](#) command) or Card Reset (send the [SYSTem:CPON](#) command) does not affect the current sensor type.

**Return Format** The query returns TC, RTD, or THER for each channel specified. Multiple return values are separated by commas.

**Example** TEMP:TRAN:TYPE FRTD,(@101:103)  
TEMP:TRAN:TYPE? (@101:103,205)

The query returns FRTD,FRTD,FRTD,TC.

**Related command** [SENSe Command Subsystem](#)

## [SENSe:]TOTAlize:CLEAr:IMMediate

**Syntax** [SENSe:]TOTAlize:CLEAr:IMMediate [(@<ch\_list>)]

**Description** Clear the counts of the specified totalizer channels immediately.

**Parameters**

Name	Type	Range	Default
<ch_list>	Channel List	One or more channels (only for the TOT channels), the rules are as follows: (@105): channel 05 on the module in Slot1; (@105:108): channel 05 through 08 on the module in Slot1; (@105:108,305): channel 05 through 08 on the module in Slot1 and channel 05 on the module in Slot3.	If the parameter is omitted, this command will be applied to the whole scan list.

- Explanation**
- The totalizer channels are numbered as "S05" to "S08"; wherein, S is the number of the slot.
  - The [\\*RST](#) command will clear the count on the totalizer channels. An Instrument Preset (send the [SYSTem:PRESet](#) command) or Card Reset (send the [SYSTem:CPON](#) command) does not affect the current count of the TOT channel.

**Example** TOT:CLE:IMM (@105)  
TOT:DATA? (@105)

The query returns +0.00000000E+00.

**Related command** [\[SENSe:\]TOTAlize:DATA?](#)

## [SENSe:]TOTAlize:DATA?

**Syntax** [SENSe:]TOTAlize:DATA? [(@<ch\_list>)]

**Description** Read the counts of the specified totalizer channels.

**Parameters**

Name	Type	Range	Default
<ch_list>	Channel List	One or more channels (only for the TOT channels), the rules are as follows: (@105): channel 05 on the module in Slot1; (@105:108): channel 05 through 08 on the module in Slot1; (@105:108,305): channel 05 through 08 on	If the parameter is omitted, this command will be applied to the whole scan list.

		the module in Slot1 and channel 05 on the module in Slot3.	
--	--	--	--

- Explanation**
- The totalizer channels are numbered as "S05" to "S08"; wherein, S is the number of the slot.
  - If the specified TOT channel is set to the PRESet mode (using the [CONFigure:TOTalize](#) and [\[SENSe:\]TOTalize:TYPE](#) commands), this command will read the count and clear it no matter whether the specified channel is in the scan list or whether a scan is in progress.
  - The maximum count of each TOT channel is 42,9496,7295( $2^{32} - 1$ ). The count rolls over to 0 after reaching the maximum allowed value.
  - The return value from of this command is affected by the settings of the [FORMat Command Subsystem](#) commands. Depending on the settings, each reading may or may not contain the measurement units, time stamp, channel number and alarm status information.

**Return Format** The query returns the count in scientific notation for each totalizer channel specified. Multiple return values are separated by commas.

**Example** TOT:DATA? (@305)  
The query returns +1.32000000E+03.

**Related command** [\[SENSe:\]TOTalize:CLEar:IMMediate](#)

## [SENSe:]TOTalize:SLOPe

**Syntax** [SENSe:]TOTalize:SLOPe <edge>[,(@<ch\_list>)]  
[SENSe:]TOTalize:SLOPe? [(@<ch\_list>)]

**Description** Set the specified totalizer channels to count when the rising edge or falling edge of the input signal passes through the threshold.

**Parameters**

Name	Type	Range	Default
<edge>	Discrete	{NEGative POSitive}	POS
<ch_list>	Channel List	One or more channels (only for the TOT channels), the rules are as follows: (@105): channel 05 on the module in Slot1; (@105:108): channel 05 through 08 on the module in Slot1; (@105:108,305): channel 05 through 08 on the module in Slot1 and channel 05 on the module in Slot3.	If the parameter is omitted, this command will be applied to the whole scan list.

- Explanation**
- The totalizer channels are numbered as "S05" to "S08"; wherein, S is the number of the slot.
  - The [CONFigure:TOTalize](#) or [MEASure:TOTalize?](#) command automatically set the specified totalizer channels to count when the rising edge of the input signal passes through the threshold.
  - The instrument automatically sets the specified totalizer channels to count when the rising edge of the input signal passes through the threshold after a Factory Reset (send the [\\*RST](#) command). An Instrument Preset (send the [SYSTem:PRESet](#) command) or Card Reset (send the [SYSTem:CPON](#) command) does not affect the current setting.

**Return** The query returns NEG (falling edge) or POS (rising edge) for each specified channel.

**Format** Multiple return values are separated by commas.

**Example** TOT:SLOP NEG,(@105)  
TOT:SLOP? (@105,106)

The query returns NEG,POS.

## [SENSe:]TOTAlize:START[:IMMediate]

**Syntax** [SENSe:]TOTAlize:START[:IMMediate] [(@<ch\_list>)]

**Description** Enable the specified totalizer channels to start counting immediately.

Parameters	Name	Type	Range	Default
	<ch_list>	Channel List	One or more channels (only for the TOT channels), the rules are as follows: (@105): channel 05 on the module in Slot1; (@105:108): channel 05 through 08 on the module in Slot1; (@105:108,305): channel 05 through 08 on the module in Slot1 and channel 05 on the module in Slot3.	If the parameter is omitted, this command will be applied to the whole scan list.

**Explanation** ➤ The totalizer channels are numbered as "S05" to "S08"; wherein, S is the number of the slot.

**Example** TOT:START:IMM (@105)

**Related commands** [SENSe Command Subsystem](#)  
[\[SENSe:\]TOTAlize:STOP\[:IMMediate\]](#)  
[\[SENSe:\]TOTAlize:DATA?](#)

## [SENSe:]TOTAlize:START:DEFault

**Syntax** [SENSe:]TOTAlize:START:DEFault [(@<ch\_list>)]

[SENSe:]TOTAlize:START:DEFault? [(@<ch\_list>)]

**Description** Enable the specified totalizer channels to start counting at power-on.

Parameters	Name	Type	Range	Default
	<ch_list>	Channel List	One or more channels (only for the TOT channels), the rules are as follows: (@105): channel 05 on the module in Slot1; (@105:108): channel 05 through 08 on the module in Slot1; (@105:108,305): channel 05 through 08 on the module in Slot1 and channel 05 on the module in Slot3;	If the parameter is omitted, this command will be applied to the whole scan list.

**Explanation** ➤ The totalizer channels are numbered as "S05" to "S08"; wherein, S is the number of the slot.  
➤ You can send the [\[SENSe:\]TOTAlize:DATA?](#) command to read the count.

**Return Format** The query returns 1 (enabled) or 0 (disabled) for each specified channel. Multiple return values are separated by commas.

**Example** TOT:START:DEF (@105)  
TOT:START:DEF? (@105)

The query returns 1.

**Related commands** [SENSe Command Subsystem](#)  
[\[SENSe:\]TOTAlize:STOP:DEFault](#)

## [SENSe:]TOTAlize:STOP[:IMMediate]

**Syntax** [SENSe:]TOTAlize:STOP[:IMMediate] [(@<ch\_list>)]

**Description** Enable the specified totalizer channels to stop counting immediately.

Parameters	Name	Type	Range	Default
	<ch_list>	Channel List	One or more channels (only for the TOT channels), the rules are as follows: (@105): channel 05 on the module in Slot1; (@105:108): channel 05 through 08 on the module in Slot1; (@105:108,305): channel 05 through 08 on the module in Slot1 and channel 05 on the module in Slot3.	If the parameter is omitted, this command will be applied to the whole scan list.

**Explanation** ➤ The totalizer channels are numbered as "S05" to "S08"; wherein, S is the number of the slot.

**Example** TOT:STOP:IMM (@105)

**Related commands** [SENSe Command Subsystem](#)  
[\[SENSe:\]TOTAlize:STArT\[:IMMediate\]](#)  
[\[SENSe:\]TOTAlize:DATA?](#)

## [SENSe:]TOTAlize:STOP:DEFault

**Syntax** [SENSe:]TOTAlize:STOP:DEFault [(@<ch\_list>)]

**Description** Enable the specified totalizer channels to stop counting at power-on when the specified totalizer channels are already enabled to start counting at power-on by sending the [\[SENSe:\]TOTAlize:STArT:DEFault](#) command.

Parameters	Name	Type	Range	Default
	<ch_list>	Channel List	One or more channels (only for the TOT channels), the rules are as follows: (@105): channel 05 on the module in Slot1; (@105:108): channel 05 through 08 on the module in Slot1; (@105:108,305): channel 05 through 08 on the module in Slot1 and channel 05 on the module in Slot3.	If the parameter is omitted, this command will be applied to the whole scan list.

**Explanation** ➤ The totalizer channels are numbered as "S05" to "S08"; wherein, S is the number of the slot.

**Example** TOT:STOP:IMM (@105)

**Related commands** [SENSe Command Subsystem](#)  
[\[SENSe:\]TOTAlize:DATA?](#)

**[SENSe:]TOTalize:TYPE**

**Syntax** [SENSe:]TOTalize:TYPE <mode>[,(@<ch\_list>)]

[SENSe:]TOTalize:TYPE? [(@<ch\_list>)]

**Description** Set the reading mode for the specified totalizer channels.

**Parameters**

Name	Type	Range	Default
<mode>	Discrete	{READ RRESet}	READ
<ch_list>	Channel List	One or more channels (only for the TOT channels), the rules are as follows: (@105): channel 05 on the module in Slot1; (@105:108): channel 05 through 08 on the module in Slot1; (@105:108,305): channel 05 through 08 on the module in Slot1 and channel 05 on the module in Slot3.	If the parameter is omitted, this command will be applied to the whole scan list.

- Explanation**
- The totalizer channels are numbered as "S05" to "S08"; wherein, S is the number of the slot.
  - RRESet (read&reset): read the count and reset the totalizer.  
READ: only read the count.
  - The [CONFigure:TOTalize](#) or [MEASure:TOTalize?](#) command automatically configure the specified totalizer channels to the READ mode (only read the count but do not clear the count) when the first parameter is omitted.
  - The instrument configures the specified totalizer channels to the READ mode (only read the count but do not clear the count) after a Factory Reset (send the [\\*RST](#) command). An Instrument Preset (send the [SYSTem:PRESet](#) command) or Card Reset (send the [SYSTem:CPON](#) command) does not affect the current setting.

**Return Format** The query returns RRES (read&reset) or READ (read) for each specified channel. Multiple return values are separated by commas.

**Example** TOT:TYPE RRES,(@205)

TOT:TYPE? (@205,206)

The query returns RRES,READ.

**Related commands** [SENSe Command Subsystem](#)  
[\[SENSe:\]TOTalize:DATA?](#)

## [SENSe:]TOTAlize:THReshold

**Syntax** [SENSe:]TOTAlize:THReshold <value>[,(@<ch\_list>)]

[SENSe:]TOTAlize:THReshold? [(@<ch\_list>)]

**Description** Set or query the threshold values for the specified TOT channels.

Parameters	Name	Type	Range	Default
	<value>	Numeric	Any numeric value between -12V and +12V, the resolution is 0.001 V	2.5V
	<ch_list>	Channel List	One or more channels (only for the TOT channels), the rules are as follows: (@107): channel 07 on the module in Slot1; (@107:108): channel 07 through 08 on the module in Slot1; (@107:108,307): channel 07 through 08 on the module in Slot1 and channel 07 on the module in Slot3.	If the parameter is omitted, this command will be applied to the whole scan list.

- Explanation**
- The totalizer channels are numbered "S05" to "S08"; wherein, S is the number of the slot. This function is only applicable to "S07" and "S08" TOT channels. For TOT channels "S05" and "S06", the threshold is fixed at CMOS 3.3 V.
  - The instrument starts counting when the rising edge or falling edge of the input signal passes through the specified threshold.
  - The instrument configures the threshold to 2.5V automatically after a Factory Reset (send the [\\*RST](#) command). An Instrument Preset (send the [SYSTem:PRESet](#) command) or Card Reset (send the [SYSTem:CPON](#) command) does not affect the current setting.

**Return Format** The query returns the threshold in scientific notation for each totalizer channel specified. Multiple return values are separated by commas.

**Example** TOT:THR 5,(@207)  
TOT:THR? (@207)

The query returns +5.000000000E+00.

**Related commands** [SENSe Command Subsystem](#)  
[\[SENSe:\]TOTAlize:DATA?](#)  
[\[SENSe:\]TOTAlize:SLOPe](#)

## [SENSe:]VOLTage:AC:RANGe

### [SENSe:]VOLTage[:DC]:RANGe

**Syntax** [SENSe:]VOLTage:AC:RANGe {<range>|MIN|MAX}{,(@<ch\_list>)}  
 [SENSe:]VOLTage:AC:RANGe? [{(@<ch\_list>)|MIN|MAX}]  
 [SENSe:]VOLTage[:DC]:RANGe {<range>|MIN|MAX}{,(@<ch\_list>)}  
 [SENSe:]VOLTage[:DC]:RANGe? [{(@<ch\_list>)|MIN|MAX}]

**Description** Set or query the measurement range of the ACV or DCV measurements on the specified channels.

Parameters	Name	Type	Range	Default
	<range>	Numeric	Any numeric value between 0 and 110*MAX. The final range is decided by the " <b>Principle of setting with greater value</b> " when <range> is between 0 and MAX; the final range is MAX when <range> is greater than MAX. The standard values of the range: {200mV 2V 20V 200V 300V}, wherein, MIN=200mV, MAX=300V, DEF=AUTO.	AUTO
	<ch_list>	Channel List	One or more channels (only for the multiplexer channels), the rules are as follows: (@101): channel 01 on the module in Slot1; (@101:103): channel 01 through 03 on the module in Slot1; (@101:103,301): channel 01 through 03 on the module in Slot1 and channel 01 on the module in Slot3.	If the parameter is omitted, this command will be applied to the whole scan list.

- Explanation**
- Before using this command, please configure the specified channels to AC voltage or DC voltage measurement function. Otherwise, an error will be generated.
  - If <ch\_list> is omitted, the command will be applied to the whole scan list. At this point, make sure that all the channels in the scan list are configured to AC voltage or DC voltage measurement function. Otherwise, an error will be generated.
  - Selecting a specific range for the specified channel will disable the autoranging (send the [\[SENSe:\]VOLTage:AC:RANGe:AUTO](#) or [\[SENSe:\]VOLTage\[:DC\]:RANGe:AUTO](#) command).
  - The [CONFigure:VOLTage:AC \(CONFigure:VOLTage\[:DC\]\)](#) and [MEASure:VOLTage:AC? \(MEASure:VOLTage\[:DC\]?\)](#) command automatically enables the autoranging if the first parameter is AUTO, DEF or omitted.
  - If the input signal is greater than can be measured on the selected range, the instrument gives an overload indication: "OVERLOAD" from the front panel or "±9.9E+37" from the remote interface.
  - The instrument enables autoranging after a Factory Reset (send the [\\*RST](#) command). An Instrument Preset (send the [SYSTem:PRESet](#) command) or Card Reset (send the [SYSTem:CPON](#) command) does not affect the current range setting.

**Return Format** The query returns the range in scientific notation for each channel specified. Multiple return values are separated by commas.

**Example** VOLT:DC:RANG 2,(@201:203)  
 VOLT:DC:RANG? (@201:203)

The query returns +2.00000000E+00,+2.00000000E+00, +2.00000000E+00.

You can replace DC with AC to set or query the range of the ACV measurements on the specified channels.

**Related command** [SENSe Command Subsystem](#)

## [SENSe:]VOLTage:AC:RANGe:AUTO [SENSe:]VOLTage[:DC]:RANGe:AUTO

**Syntax** [SENSe:]VOLTage:AC:RANGe:AUTO <state>[,(@<ch\_list>)]  
[SENSe:]VOLTage:AC:RANGe:AUTO? [(@<ch\_list>)]  
[SENSe:]VOLTage[:DC]:RANGe:AUTO <state>[,(@<ch\_list>)]  
[SENSe:]VOLTage[:DC]:RANGe:AUTO? [(@<ch\_list>)]

**Description** Enable or disable the autoranging of the ACV or DCV measurements on the specified channels.

Parameters	Name	Type	Range	Default
	<state>	Bool	{OFF 0 ON 1}	ON
	<ch_list>	Channel List	One or more channels (only for the multiplexer channels), the rules are as follows: (@101): channel 01 on the module in Slot1; (@101:103): channel 01 through 03 on the module in Slot1; (@101:103,301): channel 01 through 03 on the module in Slot1 and channel 01 on the module in Slot3.	If the parameter is omitted, this command will be applied to the whole scan list.

- Explanation**
- Before using this command, please configure the specified channels to AC voltage or DC voltage measurement function. Otherwise, an error will be generated.
  - If <ch\_list> is omitted, the command will be applied to the whole scan list. At this point, make sure that all the channels in the scan list are configured to AC voltage or DC voltage measurement function. Otherwise, an error will be generated.
  - Autoranging rule: for signals under test that is between 10%\*Range and 110%\*Range, the instrument automatically selects Range as the current range.
  - Selecting a specific range for the specified channel will disable the autoranging (send the [\[SENSe:\]VOLTage:AC:RANGe](#) or [\[SENSe:\]VOLTage\[:DC\]:RANGe](#) command).
  - The [CONFigure:VOLTage:AC](#) ([CONFigure:VOLTage\[:DC\]](#)) or [MEASure:VOLTage:AC?](#) ([MEASure:VOLTage\[:DC\]?](#)) command automatically enables the autoranging if the first parameter is AUTO, DEF or omitted.
  - The instrument selects autoranging after a Factory Reset (send the [\\*RST](#) command). An Instrument Preset (send the [SYSTem:PRESet](#) command) or Card Reset (send the [SYSTem:CPON](#) command) does not affect the current range setting.

**Return Format** The query returns 0 (OFF) or 1 (ON). Multiple return values are separated by commas.

**Example** VOLT:AC:RANG:AUTO OFF,(@201:203)  
VOLT:AC:RANG:AUTO? (@201:203)

The query returns 0,0,0.



You can replace AC with DC to enable or disable the autoranging of the DCV measurements on the specified channels.

**Related command** [SENSe Command Subsystem](#)

## [SENSe:]VOLTage:AC:BANDwidth

**Syntax** [SENSe:]VOLTage:AC:BANDwidth {<filter>|MIN|MAX}[,(@<ch\_list>)]

[SENSe:]VOLTage:AC:BANDwidth? [{{(@<ch\_list>)|MIN|MAX}]

**Description** Set or query the AC filter parameter of the ACV measurements on the specified channels.

### Parameters

Name	Type	Range	Default
<filter>	Numeric	Any integer between MIN and 1000000. The final AC filter is decided by the " <b>Principle of setting with smaller value</b> ". The standard values of the range: {3 20 200} Wherein: MIN=3Hz, MAX=200Hz.	20Hz
<ch_list>	Channel List	One or more channels (only for the multiplexer channels), the rules are as follows: (@101): channel 01 on the module in Slot1; (@101:103): channel 01 through 03 on the module in Slot; (@101:103,301): channel 01 through 03 on the module in Slot1 and channel 01 on the module in Slot3.	If the parameter is omitted, this command will be applied to the whole scan list.

- Explanation**
- Before using this command, please configure the specified channels to AC voltage measurement function. Otherwise, an error will be generated.
  - If <ch\_list> is omitted, the command will be applied to the whole scan list. At this point, make sure that all the channels in the scan list are configured to AC voltage measurement function. Otherwise, an error will be generated.
  - <filter> cannot be a decimal number. Otherwise, an error will be generated.
  - During the measurement, the filter type is determined by the frequency of the input signal of the current channel as shown in the table below.
- | Input Frequency   | AC Filter Type |
|-------------------|----------------|
| 3 Hz to 300 kHz   | 3 Hz (slow)    |
| 20 Hz to 300 kHz  | 20 Hz (medium) |
| 200 Hz to 300 kHz | 200 Hz (fast)  |
- The [CONFigure:VOLTage:AC](#) and [MEASure:VOLTage:AC?](#) commands automatically select the 20 Hz filter.
  - The instrument selects the 20 Hz filter automatically after a Factory Reset (send the [\\*RST](#) command). An Instrument Preset (send the [SYSTem:PRESet](#) command) or Card Reset (send the [SYSTem:CPON](#) command) does not affect the current AC filter parameter.

**Return Format** The query returns the AC filter parameter in scientific notation for each channel specified. Multiple return values are separated by commas.

**Example** VOLT:AC:BAND 200,(@201,203)  
VOLT:AC:BAND? (@201,203)

The query returns +2.000000000E+02, +2.000000000E+02.

**Related command** [SENSe Command Subsystem](#)

## [SENSe:]VOLTage:AC:RESolution

**Syntax** [SENSe:]VOLTage:AC:RESolution {<resolution>|MIN|MAX}{[,(@<ch\_list>)]  
[SENSe:]VOLTage:AC:RESolution? [{(@<ch\_list>)|MIN|MAX}]

**Description** Set or query the resolution of the ACV measurements on the specified channels.

Parameters	Name	Type	Range	Default
	<resolution>	Numeric	Can receive any numeric value, but the resolution is fixed at $6^{1/2}$ digits.	
	<ch_list>	Channel List	One or more channels (only for the multiplexer channels), the rules are as follows: (@101): channel 01 on the module in Slot1; (@101:103): channel 01 through 03 on the module in Slot1; (@101:103,301): channel 01 through 03 on the module in Slot1 and channel 01 on the module in Slot3.	If the parameter is omitted, this command will be applied to the whole scan list.

- Explanation**
- Before using this command, please configure the specified channels to AC voltage measurement function. Otherwise, an error will be generated.
  - If <ch\_list> is omitted, the command will be applied to the whole scan list. At this point, make sure that all the channels in the scan list are configured to AC voltage measurement function. Otherwise, an error will be generated.
  - When the range is set to autoranging, an error will be generated when <resolution> is set to a numeric value (except MIN and MAX).

**Return Format** The query returns the resolution in the form of scientific notation for each channel specified. Multiple responses are separated by commas.

**Example** VOLT:AC:RES MIN,(@101)  
VOLT:AC:RES? (@101)

The query returns +2.000000000E-05.

**Related commands** [\[SENSe:\]VOLTage:AC:RANGe](#)  
[\[SENSe:\]VOLTage:AC:RANGe:AUTO](#)  
[CONFigure:VOLTage:AC](#)  
[MEASure:VOLTage:AC?](#)

**[SENSe:]VOLTage[:DC]:APERture**

**Syntax** [SENSe:]VOLTage[:DC]:APERture {<time>|MIN|MAX}[,(@<ch\_list>)]

[SENSe:]VOLTage[:DC]:APERture? [,{(@<ch\_list>)|MIN|MAX}]

**Description** Set or query the integration time via the aperture time mode for the DCV measurements on the specified channels.

**Parameters**

Name	Type	Range	Default
<time>	Numeric	Any numeric value between MIN and MAX. MIN=33 $\mu$ s, MAX=4 s.	None
<ch_list>	Channel List	One or more channels (only for the multiplexer channels), the rules are as follows: (@101): channel 01 on the module in Slot1; (@101:103): channel 01 through 03 on the module in Slot1; (@101:103,301): channel 01 through 03 on the module in Slot1 and channel 01 on the module in Slot3.	If the parameter is omitted, this command will be applied to the whole scan list.

- Explanation**
- Before using this command, please configure the specified channels to DC voltage measurement function. Otherwise, an error will be generated.
  - If <ch\_list> is omitted, the command will be applied to the whole scan list. At this point, make sure that all the channels in the scan list are configured to DC voltage measurement function. Otherwise, an error will be generated.
  - The [CONFigure:VOLTage\[:DC\]](#), [MEASure:VOLTage\[:DC\]?](#), [\[SENSe:\]VOLTage\[:DC\]:NPLC](#) or [\[SENSe:\]VOLTage\[:DC\]:RESolution](#) command automatically disables the aperture time mode and enables the power line cycles mode.
  - You can use MIN or MAX to set <time>.
  - In the aperture time mode, the instrument selects the minimum resolution (namely, 0.03ppm× <range>).
  - The aperture time mode is disabled after a Factory Reset (send the [\\*RST](#) command). An Instrument Preset (send the [SYSTem:PRESet](#) command) or Card Reset (send the [SYSTem:CPON](#) command) does not affect the current integration time parameter.

**Return** The query returns the integration time in scientific notation for each channel specified.

**Format** Multiple return values are separated by commas.

**Example** VOLT:DC:APER 0.01,(@201:203)  
VOLT:DC:APER? (@201:203)

The query returns +1.00000000E-02,+1.00000000E-02,+1.00000000E-02.

**Related command** [SENSe Command Subsystem](#)

## [SENSe:]VOLTage[:DC]:NPLC

**Syntax** [SENSe:]VOLTage[:DC]:NPLC {<PLCs>|MIN|MAX}[,(@<ch\_list>)]

[SENSe:]VOLTage[:DC]:NPLC? [{{(@<ch\_list>)|MIN|MAX}]

**Description** Set or query the integration time via the power line cycles mode for the DCV measurements on the specified channels.

Parameters	Name	Type	Range	Default
	<PLCs>	Numeric	Any numeric value between MIN and MAX. The final integration time is decided by the " <b>Principle of setting with greater value</b> ". The standard values of the range: {0.02 0.2 1 2 10 20 100 200} Wherein: MIN=0.02PLC, MAX=200PLC.	1PLC
	<ch_list>	Channel List	One or more channels (only for the multiplexer channels), the rules are as follows: (@101): channel 01 on the module in Slot1; (@101:103): channel 01 through 03 on the module in Slot1; (@101:103,301): channel 01 through 03 on the module in Slot1 and channel 01 on the module in Slot3.	If the parameter is omitted, this command will be applied to the whole scan list.

- Explanation**
- Before using this command, please configure the specified channels to DC voltage measurement function. Otherwise, an error will be generated.
  - If <ch\_list> is omitted, the command will be applied to the whole scan list. At this point, make sure that all the channels in the scan list are configured to DC voltage measurement function. Otherwise, an error will be generated.
  - The longer the integration time is, the slower the measurement speed and the better the measurement resolution will be; the shorter the integration time is, the faster the measurement speed and the lower the measurement resolution will be.
  - You can also set the integration time via the aperture time mode (send the [\[SENSe:\]VOLTage\[:DC\]:APERture](#) command).
  - The instrument sets the integration time to 1 PLC after a Factory Reset (send the [\\*RST](#) command). An Instrument Preset (send the [SYSTem:PRESet](#) command) or Card Reset (send the [SYSTem:CPON](#) command) does not affect the current integration time parameter.

**Return** The query returns the integration time in scientific notation for each channel specified.

**Format** Multiple return values are separated by commas.

**Example** VOLT:DC:NPLC 100,(@201:203)  
VOLT:DC:NPLC? (@201:203)

The query returns +1.00000000E+02,+1.00000000E+02,+1.00000000E+02.

**Related commands** [SENSe Command Subsystem](#)  
[\[SENSe:\]VOLTage\[:DC\]:RESolution](#)  
[CONFigure:VOLTage\[:DC\]](#)  
[MEASure:VOLTage\[:DC\]?](#)

## [SENSe:]VOLTage[:DC]:RESolution

**Syntax** [SENSe:]VOLTage[:DC]:RESolution {<resolution>|MIN|MAX}[,(@<ch\_list>)]

[SENSe:]VOLTage[:DC]:RESolution? [,{(@<ch\_list>)|MIN|MAX}]

**Description** Set or query the resolution of the DCV measurements on the specified channels.

**Parameters**

Name	Type	Range	Default
<resolution>	Numeric	Any numeric value between $0.03\text{ppm} \times \langle \text{range} \rangle$ and $3\text{ppm} \times \langle \text{range} \rangle$ . The final resolution is decided by the " <b>Principle of setting with smaller value</b> ". The standard values of the resolution: refer to the " <b>Explanation</b> ".	$0.3\text{ppm} \times \langle \text{range} \rangle$
<ch_list>	Channel List	One or more channels (only for the multiplexer channels), the rules are as follows: (@101): channel 01 on the module in Slot1; (@101:103): channel 01 through 03 on the module in Slot1; (@101:103,301): channel 01 through 03 on the module in Slot1 and channel 01 on the module in Slot3.	If the parameter is omitted, this command will be applied to the whole scan list.

- Explanation**
- Before using this command, please configure the specified channels to DC voltage measurement function. Otherwise, an error will be generated.
  - If <ch\_list> is omitted, the command will be applied to the whole scan list. At this point, make sure that all the channels in the scan list are configured to DC voltage measurement function. Otherwise, an error will be generated.
  - You can use MIN or MAX to set <resolution>. Wherein, MIN selects the smallest resolution; MAX selects the largest resolution.
  - <resolution> is related to the current integration time and range (<range>). The relations are as shown in the table below.

Integration time	Resolution (ppm range)
0.02PLC	$3\text{ppm} \times \langle \text{range} \rangle$ (MAX)
0.2PLC	$0.7\text{ppm} \times \langle \text{range} \rangle$
1PLC	$0.3\text{ppm} \times \langle \text{range} \rangle$ (DEF)
2PLC	$0.2\text{ppm} \times \langle \text{range} \rangle$
10PLC	$0.1\text{ppm} \times \langle \text{range} \rangle$
20PLC	$0.06\text{ppm} \times \langle \text{range} \rangle$
100PLC	$0.035\text{ppm} \times \langle \text{range} \rangle$
200PLC	$0.03\text{ppm} \times \langle \text{range} \rangle$ (MIN)
Aperture Time Mode	$0.03\text{ppm} \times \langle \text{range} \rangle$ (MIN)

- When the range is set to autoranging, an error will be generated when <resolution> is set to a numeric value (except MIN and MAX).
- The instrument sets the resolution to  $0.3\text{ppm} \times \langle \text{range} \rangle$  after a Factory Reset (send the **\*RST** command). An Instrument Preset (send the **SYSTem:PRESet** command) or Card Reset (send the **SYSTem:CPON** command) does not affect the current resolution.

**Return Format** The query returns the resolution in scientific notation for each channel specified. Multiple return values are separated by commas.

**Example** VOLT:DC:RANG 300,(@201:203)

```
VOLT:DC:RES 0.006,(@201:203)
VOLT:DC:RES? (@201:203)
```

The query returns +9.00000000E-04,+9.00000000E-04,+9.00000000E-04.

### Related commands

[SENSe Command Subsystem](#)

[\[SENSe:\]VOLTage\[:DC\]:RANGE](#)

[\[SENSe:\]VOLTage\[:DC\]:APERTure](#)

[\[SENSe:\]VOLTage\[:DC\]:NPLC](#)

[CONFigure:VOLTage\[:DC\]](#)

[MEASure:VOLTage\[:DC\]?](#)

## [SENSe:]ZERO:AUTO

**Syntax** [SENSe:]ZERO:AUTO <mode>[,(@<ch\_list>)]

[SENSe:]ZERO:AUTO? [(@<ch\_list>)]

### Description

Enable or disable the autozero function of the specified channels.

### Parameters

Name	Type	Range	Default
<mode>	Discrete	{OFF ON}	ON
<ch_list>	Channel List	One or more channels (only for the multiplexer channels), the rules are as follows: (@101): channel 01 on the module in Slot1; (@101:103): channel 01 through 03 on the module in Slot1; (@101:103,301): channel 01 through 03 on the module in Slot1 and channel 01 on the module in Slot3.	If the parameter is omitted, this command will be applied to the whole scan list.

### Explanation

- Before using this command, please configure the specified channels to DCV, DCI, temperature or any sensor (except the FREQ sensor) measurement function. Otherwise, an error will be generated.
- If <ch\_list> is omitted, the command will be applied to the whole scan list. At this point, make sure that all the channels in the scan list are configured to DCV, DCI, temperature or any sensor (except the FREQ sensor) measurement function. Otherwise, an error will be generated.
- The [CONFigure Command Subsystem](#) or [MEASure Command Subsystem](#) commands automatically enable the autozero function.
- Auto zero and offset compensation are mutually exclusive. After enabling the autozero function, the offset compensation will be disabled automatically.
- The instrument enables the autozero function after a Factory Reset (send the [\\*RST](#) command). An Instrument Preset (send the [SYSTem:PRESet](#) command) or Card Reset (send the [SYSTem:CPON](#) command) does not affect the current offset compensation status.

### Return Format

The query form returns 0 (OFF) or 1(ON). Multiple return values are separated by commas.

### Example

```
ZERO:AUTO OFF,(@102:104)
ZERO:AUTO? (@102:104)
The query returns 0,0,0.
```

### Related command

[SENSe Command Subsystem](#)

## SOURce Command Subsystem

- [SOURce:DIgital:DATA\[:BYTE\]](#)
- [SOURce:DIgital:DATA:DWORd](#)
- [SOURce:DIgital:DATA:WORd](#)
- [SOURce:DIgital:STATe?](#)
- [SOURce:VOLTage](#)

### SOURce:DIgital:DATA[:BYTE] SOURce:DIgital:DATA:DWORd SOURce:DIgital:DATA:WORd

**Syntax** SOURce:DIgital:DATA[:BYTE] <data>,(@<ch\_list>)  
 SOURce:DIgital:DATA[:BYTE]? (@<ch\_list>)  
 SOURce:DIgital:DATA:DWORd <data>,(@<ch\_list>)  
 SOURce:DIgital:DATA:DWORd? (@<ch\_list>)  
 SOURce:DIgital:DATA:WORd <data>,(@<ch\_list>)  
 SOURce:DIgital:DATA:WORd? (@<ch\_list>)

**Description** Set the specified DIO channels to output the specified values in 8-bit (BYTE), 16-bit (WORD) or 32-bit (DWORD).

#### Parameters

Name	Type	Range	Default
<data>	Integer	8-bit: 0 to 255 16-bit: 0 to 65535 32-bit: 0 to 42,9496,7295	None
<ch_list>	Channel List	One or more channels (only for channel 01 to channel 04 of the multifunction module), the rules are as follows: (@101): channel 01 on the module in Slot1; (@101:103): channel 01 through 03 on the module in Slot1; (@101:103,301): channel 01 through 03 on the module in Slot1 and channel 01 on the module in Slot3.	None

- Explanation**
- Only DIO channels that have not been added into the scan list can be used as the digital output terminal (DOUT).
  - <data> can be a decimal number (216), a binary number (#b11011000) or a hexadecimal number (#hD8).
  - The SOURce:DIgital:DATA[:BYTE] <data>,(@<ch\_list>) command is applicable to S01 to S04.  
 The SOURce:DIgital:DATA:WORd <data>,(@<ch\_list>) command is only applicable to S01 and S03. At this point, S01 (LSB) and S02 (MSB) as well as S03 (LSB) and S04 (MSB) are configured as two 16-bit digital output terminals.  
 The SOURce:DIgital:DATA:DWORd <data>,(@<ch\_list>) command is only applicable to S01. At this point, S01 (LSB), S02, S03 and S04 (MSB) are configured as a 32-bit digital output terminal.  
 If (@<ch\_list>) does not match the above conditions, an error will be generated.

**Return Format** The query returns the signed decimal numbers. Multiple return values are separated by commas.

**Example** SOUR:DIG:DATA:BYTE 219,(@101:104)  
 SOUR:DIG:DATA:WORD #b0101010110101010,(@101,103)  
 SOUR:DIG:DATA:DWORD #h55aa,(@101)  
 SOUR:DIG:DATA:DWORD? (@101)

The query returns +21930.

**Related command** [SOURce Command Subsystem](#)

## SOURce:DIGital:STATe?

**Syntax** SOURce:DIGital:STATe? (@<ch\_list>)

**Description** Query the status (input or output) of the specified DIO channels.

Parameters	Name	Type	Range	Default
	<ch_list>	Channel List	One or more channels (only for DIO channels), the rules are as follows: (@101): channel 01 on the module in Slot1; (@101:103): channel 01 through 03 on the module in Slot1; (@101:103,301): channel 01 through 03 on the module in Slot1 and channel 01 on the module in Slot3.	None

- Explanation**
- The [SOURce:DIGital:DATA\[:BYTE\]?](#), [SOURce:DIGital:DATA:DWORD](#) or [SOURce:DIGital:DATA:WORD](#) command sets the specified DIO channels as the output terminals.
  - The [\[SENSe:\]DIGital:DATA\[:BYTE\]?](#), [\[SENSe:\]DIGital:DATA:WORD?](#) or [\[SENSe:\]DIGital:DATA:DWORD?](#) Command sets the specified DIO channels as the input terminals. Adding the DIO channels into the scan list will also set the DIO terminals as the input terminals.
  - The DIO channels will be configured as 8-bit input terminals after a Factory Reset (send the [\\*RST](#) command) or an Instrument Preset (send the [SYSTem:PRESet](#) command). A Card Reset (send the [SYSTem:CPON](#) command) does not affect the current DIO channel status.

**Return Format** The query returns 0 (digital input) or 1 (digital output). Multiple return values are separated by commas.

**Example** SOUR:DIG:STAT? (@101:104)  
 The query returns 1,1,0,0.



## SOURce:VOLTage

**Syntax** SOURce:VOLTage <voltage>,(@<ch\_list>)

SOURce:VOLTage? (@<ch\_list>)

**Description** Set or query the analog output voltages of the specified DAC channels.

**Parameters**

Name	Type	Range	Default
<voltage>	Numeric	Any numeric value between -12V and +12V.	0 V
<ch_list>	Channel List	One or more channels (only for channel 09 through channel 12 of the multifunction module), the rules are as follows: (@109): channel 09 on the module in Slot1; (@109:112): channel 09 through 12 on the module in Slot1; (@109:112,309,409:410): channel 09 through 12 on the module in Slot1, channel 09 on the module in Slot3 and channel 09 through 10 on the module in Slot4.	None

- Explanation**
- The DAC channels are numbered "S09" to "S12"; wherein, S is the number of the slot.
  - A Factory Reset (send the [\\*RST](#) command), Instrument Preset (send the [SYSTem:PRESet](#) command) or Card Reset (send the [SYSTem:CPON](#) command) does not affect the current setting.

**Return Format** The query returns the analog voltage in scientific notation for each specified channel. Multiple return values are separated by commas.

**Example** SOUR:VOLT 5.0,(@409:412)  
 SOUR:VOLT? (@409:412)

The query returns  
 +5.000000000E+00,+5.000000000E+00,+5.000000000E+00,+5.000000000E+00.

**Related command** [SOURce Command Subsystem](#)

## STATus Command Subsystem

- [STATus:ALARm:CONDition?](#)
- [STATus:ALARm:ENABLE](#)
- [STATus:ALARm\[:EVENT\]?](#)
- [STATus:OPERation:CONDition?](#)
- [STATus:OPERation:ENABLE](#)
- [STATus:OPERation\[:EVENT\]?](#)
- [STATus:PRESet](#)
- [STATus:QUEStionable:CONDition?](#)
- [STATus:QUEStionable:ENABLE](#)
- [STATus:QUEStionable\[:EVENT\]?](#)

**Explanation:** The M300 status system is as shown in Figure 1-2.

### STATus:ALARm:CONDition?

**Syntax** STATus:ALARm:CONDition?

**Description** Read and clear the condition register of the Alarm Register set.

- Explanation**
- The condition register is read-only and will not be cleared when you read the register.
  - Sending the [\\*CLS](#) command will clear the alarm queue and the "Queue Not Empty" bit (bit4) in the condition register.
  - The bit definitions of the alarm condition register are as shown in the table below.

Bit	Bit Name	Weight	Definition
0-3	Not Used	1-8	Always be 0.
4	Queue Not Empty	16	The alarm queue is not empty.
5	Not Used	32	Always be 0.
6	Alarm 1	64	Alarm 1 is triggered.
7	Alarm 2	128	Alarm 2 is triggered.
8	Alarm 3	256	Alarm 3 is triggered.
9	Alarm 4	512	Alarm 4 is triggered.
10-11	Not Used	1024-2048	Always be 0.
12	Lower Limit	4096	A lower limit alarm has occurred.
13	Upper Limit	8192	An upper limit alarm has occurred.
14-15	Not Used	16384-32768	Always be 0.

**Return Format** The query returns an integer which corresponds to the binary-weighted sum of all the bits in the register. For example, if bit 4 (16 in decimal) and bit 12 (4096 in decimal) are enabled, this command will return 4112 (#b1000000010000).

**Example** STAT:ALAR:COND?

The query retruns 4112.

**Related commands**

- [STATus Command Subsystem](#)
- [STATus:ALARm:ENABLE](#)
- [STATus:ALARm\[:EVENT\]?](#)
- [SYSTem:ALARm?](#)

## STATus:ALARm:ENABle

**Syntax** STATus:ALARm:ENABle <enable value>  
STATus:ALARm:ENABle?

**Description** Set or query the enable register for the Alarm Register set.

Parameters	Name	Type	Range	Default
	<enable value>	Integer	0 to 65535	None

- Explanation**
- When the events correspond to the bits that are set to 1 in the register occurs, the bits are then reported to the status byte register.
  - Sending the [STATus:PRESet](#) command will set this register to 0.
  - The bit definitions for the alarm enable register are as shown in the table below.

Bit	Bit Name	Weight	Definition
0-3	Not Used	1-8	Always be 0.
4	Queue Not Empty	16	The alarm queue is not empty.
5	Not Used	32	Always be 0.
6	Alarm 1	64	Alarm 1 is triggered.
7	Alarm 2	128	Alarm 2 is triggered.
8	Alarm 3	256	Alarm 3 is triggered.
9	Alarm 4	512	Alarm 4 is triggered.
10-11	Not Used	1024-2048	Always be 0.
12	Lower Limit	4096	A lower limit alarm has occurred.
13	Upper Limit	8192	An upper limit alarm has occurred.
14-15	Not Used	16384-32768	Always be 0.

**Return Format** The query returns an integer which corresponds to the binary-weighted sum of all the bits in the register. For example, if bit 4 (16 in decimal) and bit 12 (4096 in decimal) are enabled, this command will return 4112 (#b1000000010000).

**Example** STAT:ALAR:ENAB 4112  
STAT:ALAR:ENAB?

The query returns 4112.

**Related commands** [STATus Command Subsystem](#)  
[STATus:ALARm:CONDition?](#)  
[STATus:ALARm\[:EVENT\]?](#)

## STATus:ALARm[:EVENT]?

**Syntax** STATus:ALARm[:EVENT]?

**Description** Query the event register for the Alarm Register set.

- Explanation**
- As the event register is read-only, once a bit is set to 1, it remains set until cleared by the query command (such as the STAT:ALAR:EVENT? command) or the [\\*CLS](#) command.
  - The bit definitions for the alarm event register are as shown in the table below.

Bit	Bit Name	Weight	Definition
0-3	Not Used	1-8	Always be 0.
4	Queue Not Empty	16	The alarm queue is not empty.
5	Not Used	32	Always be 0.
6	Alarm 1	64	Alarm 1 is triggered.
7	Alarm 2	128	Alarm 2 is triggered.
8	Alarm 3	256	Alarm 3 is triggered.
9	Alarm 4	512	Alarm 4 is triggered.
10-11	Not Used	1024-2048	Always be 0.
12	Lower Limit	4096	A lower limit alarm has occurred.
13	Upper Limit	8192	An upper limit alarm has occurred.
14-15	Not Used	16384-32768	Always be 0.

**Return Format** The query returns an integer which corresponds to the binary-weighted sum of all the bits in the register. For example, if bit 4 (16 in decimal) and bit 12 (4096 in decimal) are enabled, this command will return 4112 (#b1000000010000).

**Example** STAT:ALAR:EVENT?

The query returns 4112.

**Related commands** [STATus Command Subsystem](#)  
[STATus:ALARm:CONDition?](#)  
[STATus:ALARm:ENABLE](#)

## STATus:OPERation:CONDition?

**Syntax** STATus:OPERation:CONDition?

**Description** Query the condition register for the Operation Status Register set.

- Explanation**
- This is a read-only register and the bits are not cleared when you read the register.
  - Bit 14 (Busy) will be set to 1 while the instrument is executing a time-consuming command, such as the [MMEMory:IMPort:CONFig?](#) command.
  - A Factory Reset (send the [\\*RST](#) command) will set the "Configuration Changed" bit (bit 8) to 1 in the condition register.
  - The bit definitions for the operation status condition register.

Bit	Bit Name	Weight	Definition
0	Calibrating	1	The instrument is calibrating.
1	Self Test	2	The instrument is performing a self-test.
2	Not Used	4	Always be 0.
3	Not Used	8	Always be 0.
4	Scanning	16	The instrument is scanning.
5	WFT	32	The instrument is waiting for a trigger.
6	Not Used	64	Always be 0.
7	USB MSD	128	A USB storage device (external memory) has

	detected		been detected.
8	Config Changed	256	The scan list configuration has changed.
9	Not Used	512	Always be 0.
10	Instrument Locked	1024	The instrument is locked.
11	Not Used	2048	Always be 0.
12	Not Used	4096	Always be 0.
13	Global Error	8192	An error occurs (the error queue is not empty).
14	Busy	16384	The instrument is busy.
15	Not Used	32768	Always be 0.

**Return Format** The query returns an integer which corresponds to the binary-weighted sum of all the bits in the register. For example, if bit 4 (16 in decimal) and bit 8 (256 in decimal) are enabled, this command will return 272 (#b100010000).

**Example** STAT:OPER:COND?  
The query returns 272.

**Related commands** [STATus:OPERation:ENABLE](#)  
[STATus:OPERation\[:EVENT\]?](#)

## STATus:OPERation:ENABLE

**Syntax** STATus:OPERation:ENABle <enable\_value>  
STATus:OPERation:ENABle?

**Description** inset or query the enable register for the Operation Status Register set.

Parameters	Name	Type	Range	Default
	<enable_value>	Integer	0 to 65535	None

**Explanation**

- When the events correspond to the bits that are set to 1 in the register occurs, the bits are then reported to the status byte register.
- Bit 14 (Busy) will be set to 1 while the instrument is executing a time-consuming command, such as the [MMEMory:IMPorT:CONFig?](#) command.
- Sending the [STATus:PRESet](#) command will set this register to 0.
- The bit definitions for the operation status enable register are as shown in the table below.

Bit	Bit Name	Weight	Definition
0	Calibrating	1	The instrument is calibrating.
1	Self Test	2	The instrument is performing a self-test.
2	Not Used	4	Always be 0.
3	Not Used	8	Always be 0.
4	Scanning	16	The instrument is scanning.
5	WFT	32	The instrument is waiting for a trigger.
6	Not Used	64	Always be 0.
7	USB MSD detected	128	A USB storage device (external memory) has been detected.
8	Config Changed	256	The scan list configuration has changed.
9	Mem Threshold	512	The number of readings in the memory has exceeded the memory threshold setting (refer to the <a href="#">DATA:POINts:EVENT:THReshold</a> comamnd).
10	Instrument Locked	1024	The instrument is locked.

11	Settings Changed	2048	The instrument's settings have changed.
12	Not Used	4096	Always be 0.
13	Global Error	8192	An error occurs (the error queue is not empty).
14	Busy	16384	The instrument is busy.
15	Not Used	32768	Always be 0.

**Return Format** The query returns an integer that corresponds to the binary-weighted sum of all the bits in the register. For example, if bit 1 (2 in decimal) and bit 4 (16 in decimal) are enabled, the query will return 18 (#b100010010).

**Example** STAT:OPER:ENAB 18  
STAT:OPER:ENAB?

The query returns 18.

**Related commands** [STATus:OPERation:CONDition?](#)  
[STATus:OPERation\[:EVENT\]?](#)

## STATus:OPERation[:EVENT]?

**Syntax** STATus:OPERation[:EVENT]?

**Description** Read and clear the condition register for the Operation Status Register set.

**Explanation**

- As the event register is read-only, once a bit is set to 1, it remains set until cleared by the query command (such as the STAT:ALAR:EVENT? command) or the [\\*CLS](#) command.
- The bit definitions for the operation status event register are as shown in the table below.

Bit	Bit Name	Weight	Definition
0	Calibrating	1	The instrument is calibrating.
1	Self Test	2	The instrument is performing a self-test.
2	Not Used	4	Always be 0.
3	Not Used	8	Always be 0.
4	Scanning	16	The instrument is scanning.
5	WFT	32	The instrument is waiting for a trigger.
6	Not Used	64	Always be 0.
7	USB MSD detected	128	A USB storage device (external memory) has been detected.
8	Config Changed	256	The scan list configuration has changed.
9	Mem Threshold	512	The number of readings in the memory has exceeded the memory threshold setting (refer to the <a href="#">DATA:POINts:EVENT:THReshold</a> command).
10	Instrument Locked	1024	The instrument is locked.
11	Settings Changed	2048	The instrument's settings have changed.
12	Not Used	4096	Always be 0.
13	Global Error	8192	An error occurs (the error queue is not empty).
14	Busy	16384	The instrument is busy.
15	Not Used	32768	Always be 0.

**Return Format** The query returns an integer which corresponds to the binary-weighted sum of all the bits in the register. For example, if bit 4 (2 in decimal), bit 7 (16 in decimal) and bit 8 (16 in decimal) are set, this command will return 784 (#b1100010000).

**Example** STAT:OPER?

The query returns 784.

**Related commands** [STATus:OPERation:CONDition?](#)  
[STATus:OPERation:ENABLE](#)

## STATus:PRESet

**Syntax** STATus:PRESet

**Description** Clear the alarm enable register, the operation status enable register and the questionable status enable register.

**Example** STAT:PRES  
 STAT:ALAR:ENAB?

The query returns 0.

**Related commands** [STATus:ALARm:ENABLE](#)  
[STATus:OPERation:ENABLE](#)  
[STATus:QUESTionable:ENABLE](#)

## STATus:QUESTionable:CONDition?

**Syntax** STATus:QUESTionable:CONDition?

**Description** Query the condition register for the Questionable Status Register set.

**Explanation**

- This is a read-only register and the bits are not cleared when you read the register.
- A Factory Reset (send the [\\*RST](#) command) clears all the bits in the condition register for the Questionable Status Register set.
- The bit definitions for the questionable status condition register are as shown in the table below.

Bit	Bit Name	Weight	Definition
0-10	Not Used	1-1024	Always be 0.
11	Totalizer Overflow	2048	A totalizer has counted past its limit (42,9496,7295 ( $2^{32} - 1$ )).
12	Memory Overflow	4096	The reading memory has overflowed (10,0000).
13-15	Not Used	8192-32768	Always be 0.

**Return Format** The query returns an integer which corresponds to the binary-weighted sum of all the bits in the register. For example, if bit 12 (4096 in decimal) is set, this command will return 4096 (#b1000000000000).

**Example** STAT:QUES:COND?  
 The query returns 4096.

**Related commands** [STATus:QUESTionable:ENABLE](#)  
[STATus:QUESTionable\[:EVENT\]?](#)

## STATus:QUEStionable:ENABLE

**Syntax** STATus:QUEStionable:ENABle <enable value>  
STATus:QUEStionable:ENABle?

**Description** Set or query the enable register for the Questionable Status Register set.

Parameters	Name	Type	Range	Default
	<enable_value>	Integer	0 to 65535	None

**Explanation**

- When the events correspond to the bits that are set to 1 in the register occurs, the bits are then reported to the status byte register.
- Sending the [STATus:PRESet](#) command will set this register to 0.
- The bit definitions for the questionable status enable register are as shown in the table below.

Bit	Bit Name	Weight	Definition
0	Voltage Overload	1	The instrument has experienced a voltage overload.
1	Current Overload	2	The instrument has experienced a current overload.
2-8	Not Used	4-256	Always be 0.
9	Res Overload	512	The instrument has experienced a resistance overload.
10	Temperature Overload	1024	The instrument has experienced a temperature overload.
11	Totalizer Overflow	2048	A totalizer has counted past its limit (42,9496,7295 ( $2^{32} - 1$ )).
12	Memory Overflow	4096	The reading memory has overflowed (10,0000).
13-15	Not Used	8192-32768	Always be 0.

**Return Format** The query returns an integer that corresponds to the binary-weighted sum of all the bits in the register. For example, if bit 10 (1024 in decimal) and bit 9 (512 in decimal) are enabled, the query will return 1536 (#b1100000000).

**Example** STAT:QUES:ENAB 1536  
STAT:QUES:ENAB?

The query retruns 1536.

**Related commands** [STATus:QUEStionable:CONDition?](#)  
[STATus:QUEStionable\[:EVENT\]?](#)



## STATus:QUESTionable[:EVENT]?

**Syntax** STATus:QUESTionable[:EVENT]?

**Description** Read and clear the condition register for the Questionable Status Register set.

- Explanation**
- As the event register is read-only, once a bit is set to 1, it remains set until cleared by the query command (such as the STAT:ALAR:EVENT? command) or the [\\*CLS](#) command.
  - The bit definitions for the questionable status event register are as shown in the table below.

Bit	Bit Name	Weight	Definition
0	Voltage Overload	1	The instrument has experienced a voltage overload.
1	Current Overload	2	The instrument has experienced a current overload.
2-8	Not Used	4-256	Always be 0.
9	Res Overload	512	The instrument has experienced a resistance overload.
10	Temperature Overload	1024	The instrument has experienced a temperature overload.
11	Totalizer Overflow	2048	A totalizer has counted past its limit (42,9496,7295 ( $2^{32} - 1$ )).
12	Memory Overflow	4096	The reading memory has overflowed (10,0000).
13-15	Not Used	8192-32768	Always be 0.

**Return Format** The query returns an integer which corresponds to the binary-weighted sum of all the bits in the register. For example, if bit 0 (1 in decimal) and bit 12 (4096 in decimal) are enabled, this command will return 4097 (#b1000000000001).

**Example** STAT:QUES?

The query returns 4097.

**Related commands** [STATus:QUESTionable:CONDition?](#)  
[STATus:QUESTionable:ENABLE](#)

## SYSTem Command Subsystem

- [SYSTem:ALARm?](#)
- [SYSTem:ANALog:OUTPut:SWITCh](#)
- [SYSTem:COMMunicate:GPIB:ADDRess](#)
- [SYSTem:COMMunicate:LAN:AUTOip](#)
- [SYSTem:COMMunicate:LAN:CONTRol?](#)
- [SYSTem:COMMunicate:LAN:DHCP](#)
- [SYSTem:COMMunicate:LAN:DNS](#)
- [SYSTem:COMMunicate:LAN:GATEway](#)
- [SYSTem:COMMunicate:LAN:IPADdress](#)
- [SYSTem:COMMunicate:LAN:MAC?](#)
- [SYSTem:COMMunicate:LAN:MANUip](#)
- [SYSTem:COMMunicate:LAN:TELNet:PRoMpt](#)
- [SYSTem:COMMunicate:LAN:TELNet:WMESsage](#)
- [SYSTem:COMMunicate:LAN:SMASk](#)
- [SYSTem:COMMunicate:LAN:UPDate](#)
- [SYSTem:COMMunicate:RS232:BAUD](#)
- [SYSTem:COMMunicate:RS232:FLOWcontrol](#)
- [SYSTem:COMMunicate:RS232:PARItY](#)
- [SYSTem:COMMunicate:RS232:PRINt:STATe](#)
- [SYSTem:CPON](#)
- [SYSTem:CTYPe:DEFine](#)
- [SYSTem:CTYPe:DEFault](#)
- [SYSTem:CTYPe?](#)
- [SYSTem:DATE](#)
- [SYSTem:EDITion?](#)
- [SYSTem:ERRor?](#)
- [SYSTem:IDN:USER:DEFine](#)
- [SYSTem:IDN:DEFault](#)
- [SYSTem:LFRequency?](#)
- [SYSTem:LOCal](#)
- [SYSTem:OPENTimes?](#)
- [SYSTem:PRESet](#)
- [SYSTem:REMote](#)
- [SYSTem:RWLock](#)
- [SYSTem:SECurity\[:IMMediate\]](#)
- [SYSTem:SERIal?](#)
- [SYSTem:TIME](#)

- [SYSTem:TIME:SCAN?](#)
- [SYSTem:TYPE?](#)
- [SYSTem:UTIlity:BEEPer:STATe](#)
- [SYSTem:UTIlity:CARDooperation](#)
- [SYSTem:UTIlity:CONFigure:POWEron](#)
- [SYSTem:UTIlity:DISPlay:BRIGht](#)
- [SYSTem:UTIlity:FORMat:DECImal](#)
- [SYSTem:UTIlity:FORMat:SEPArate](#)
- [SYSTem:UTIlity:LANGuage](#)
- [SYSTem:UTIlity:POWEr:SWITCh:STATe](#)
- [SYSTem:UTIlity:SAVEr:STATe](#)
- [SYSTem:UTIlity:SAVEr:TIME](#)
- [SYSTem:VERSion?](#)

## SYSTem:ALARm?

**Syntax** SYSTem:ALARm?

**Description** Query the alarm data from the alarm queue.

- Explanation**
- An earliest alarm data is read and deleted from the alarm queue each time this command is sent.
  - Up to 100 alarms that occurred first for each alarm channel can be logged in the alarm queue.
  - When no alarm is generated, the return data is as follows.  
0+0.000000000E+00 ,0000,00,00,00,00,00.000,000,0,0
  - The alarm queue is cleared when the [\\*CLS](#) command is sent or the power is cycled. A Factory Reset (send the [\\*RST](#) command) or Instrument Preset (send the [SYSTem:PRESet](#) command) does not affect the alarm queue.

**Return Format** The query returns a series of numbers in the following format.

Format explanation:

-4.322675895E-04 V,2013,07,07,01,40,13.351,101,1,1

① Readings+unit    ② Date    ③ Time    ④ channel    ⑤ Alarm limit type + Alarm channel

Wherein, the definitions of the alarm limit types in ⑤ are: 0=None; 1=LO; 2=HI.

**Example** SYST:ALAR?

The query returns -6.077891259E-06 V,2012,01,18,00,47,39.615,501,1,1.

**Related command** [CALCulate Command Subsystem](#)

## SYSTem:ANALog:OUTPut:SWITCh

**Syntax** SYSTem:ANALog:OUTPut:SWITCh <bool>

SYSTem:ANALog:OUTPut:SWITCh?

**Description** Open or close the analog switch on the back board inside the M300 main frame.

Parameters	Name	Type	Range	Default
	<bool>	Bool	{ON OFF 0 1}	None

**Explanation** The analog switch on the back board inside the M300 main frame is used to control the connection between the multiplexer module and DMM module. When it is opened (OFF|0), the multiplexer module and DMM module are not connected; at this point, M300 cannot measure the signals input from the multiplexer channels correctly. To acquire correct measurements, the switch should be closed (ON|1).

**Return Format** The query returns 0 (OFF) or 1 (ON).

**Example** SYST:ANAL:OUTP:SWIT ON

SYST:ANAL:OUTP:SWIT?

The query returns 1.

## SYSTem:COMMunicate:GPIB:ADDRess

**Syntax** SYSTem:COMMunicate:GPIB:ADDRess <0-30>

SYSTem:COMMunicate:GPIB:ADDRess?

**Description** Set or query the GPIB address.

Parameters	Name	Type	Range	Default
	<0-30>	Integer	0 to 30.	None

**Explanation**

- Before using the GPIB interface, connect the instrument and PC using a GPIB cable and set the GPIB address.
- The GPIB address is stored in the non-volatile memory (refer to [Appendix C: Non-volatile Memory](#)) and does not change when the power has been off, after a Factory Reset (send the [\\*RST](#) command) or after an Instrument Preset (send the [SYSTem:PRESet](#) command).

**Return Format** The query returns an integer, for example, 7.

**Example** SYST:COMM:GPIB:ADDR 9

SYST:COMM:GPIB:ADDR?

Typical Response: 9

**Related command** [SYSTem Command Subsystem](#)

## SYSTem:COMMunicate:LAN:AUTOip

**Syntax** SYSTem:COMMunicate:LAN:AUTOip <mode>

SYSTem:COMMunicate:LAN:AUTOip?

**Description** Enable or disable the auto IP configuration mode.

**Parameters**

Name	Type	Range	Default
<mode>	Bool	{ON OFF 0 1}	None

- Explanation**
- In auto IP configuration mode, the instrument acquires the IP address from 169.254.0.1 to 169.254.255.254 and subnet mask 255.255.0.0 according to the current network configuration automatically.
  - When all the three configuration modes are set to "On", the priority order of parameter configuration is "DHCP", "AutoIP" and "ManualIP".
  - The three IP configuration modes cannot all be set to "Off" at the same time.
  - When the DHCP and auto IP modes are enabled at the same time, if you want to use the auto IP mode to obtain an IP address, the DHCP mode should be disabled; otherwise, the instrument automatically uses the DHCP mode.
  - This setting takes effect after the [SYSTem:COMMunicate:LAN:UPDate](#) command (update the setting) is sent.
  - The auto IP setting is stored in the non-volatile memory (refer to [Appendix C: Non-volatile Memory](#)) and does not change when the power has been off, after a Factory Reset (send the [\\*RST](#) command) or after an Instrument Preset (send the [SYSTem:PRESet](#) command).

**Return Format** The query returns 1 (ON) or 0 (OFF).

**Example** SYST:COMM:LAN:AUTO ON  
SYST:COMM:LAN:AUTO?

The query returns 1.

**Related commands** [SYSTem:COMMunicate:LAN:DHCP](#)  
[SYSTem:COMMunicate:LAN:MANUip](#)

## SYSTem:COMMunicate:LAN:CONTRol?

**Syntax** SYSTem:COMMunicate:LAN:CONTRol?

**Description** Query the control connection port number of the Socket communication.

- Explanation**
- This command is only valid when the socket mode is used for communication.
  - This query always returns +0 if the socket mode is not used for communication.

**Return Format** The query returns the control connection port number of the Socket communication. If +0 is returned, the socket mode is not used for communication.

**Example** SYST:COMM:LAN:CONT?

The query returns 5555.

**Related command** [SYSTem Command Subsystem](#)

## SYSTem:COMMunicate:LAN:DHCP

**Syntax** SYSTem:COMMunicate:LAN:DHCP <mode>  
SYSTem:COMMunicate:LAN:DHCP?

**Description** Disable or enable the DHCP configuration mode.

Parameters	Name	Type	Range	Default
	<mode>	Bool	{ON OFF 1 0}	None

- Explanation**
- In DHCP mode, the DHCP server in the current network assigns network parameters (such as the IP address) for the instrument.
  - When all the three configuration modes are set to "On", the priority order of parameter configuration is "DHCP", "AutoIP" and "ManualIP".
  - The three IP configuration modes cannot all be set to "Off" at the same time.
  - This setting takes effect after the [SYSTem:COMMunicate:LAN:UPDate](#) command (update the setting) is sent.
  - The DHCP setting is stored in the non-volatile memory (refer to [Appendix C: Non-volatile Memory](#)) and does not change when the power has been off, after a Factory Reset (send the [\\*RST](#) command) or after an Instrument Preset (send the [SYSTem:PRESet](#) command).

**Return Format** The query returns 1 (ON) or 0 (OFF).

**Example** SYST:COMM:LAN:DHCP ON  
SYST:COMM:LAN:DHCP?

The query returns 1.

**Related commands** [SYSTem:COMMunicate:LAN:AUTOip](#)  
[SYSTem:COMMunicate:LAN:MANUip](#)

## SYSTem:COMMunicate:LAN:DNS

**Syntax** SYSTem:COMMunicate:LAN:DNS "<address>"  
SYSTem:COMMunicate:LAN:DNS? [{CURRent|STATic}]

**Description** Set or query the DNS (Domain Name Service).

Parameters	Name	Type	Range	Default
	<address>	ASCII string	The format is nnn.nnn.nnn.nnn; the first nnn ranges from 1 to 223 (except 127), the other three range from 0 to 255.	None

- Explanation**
- This command is only available when the Auto IP configuration mode or manual IP configuration mode is enabled.
  - You are recommended to ask your network administrator for an address available.
  - The command has two optional parameters. Use "CURRent" to query the DNS address currently set (the [SYSTem:COMMunicate:LAN:UPDate](#) command is not executed). Use "STATic" to query the DNS address currently stored in the non-volatile memory (refer to [Appendix C: Non-volatile Memory](#)). When the parameter is omitted, the system queries the DNS address currently set.
  - The DNS address is stored in the non-volatile memory (refer to [Appendix C: Non-volatile Memory](#)) and does not change when the power has been off, after a Factory Reset (send the [\\*RST](#) command) or after an Instrument Preset (send the

[SYSTem:PRESet](#) command).

**Return Format** The query returns the current DNS address, for example, "172.16.3.2".

**Example** SYST:COMM:LAN:DNS "172.16.3.2"  
SYST:COMM:LAN:DNS? CURR

The query returns "172.16.3.2".

**Related commands** [SYSTem:COMMunicate:LAN:MANUip](#)  
[SYSTem:COMMunicate:LAN:GATEway](#)  
[SYSTem:COMMunicate:LAN:IPADdress](#)  
[SYSTem:COMMunicate:LAN:SMASK](#)

## SYSTem:COMMunicate:LAN:GATEway

**Syntax** SYSTem:COMMunicate:LAN:GATEway "<address>"  
SYSTem:COMMunicate:LAN:GATEway? [{CURRent|STATic}]

**Description** Set or query the default gateway.

**Parameters**

Name	Type	Range	Default
<address>	ASCII string	The format is nnn.nnn.nnn.nnn; the first nnn ranges from 1 to 223 (except 127), the other three range from 0 to 255.	None

**Explanation**

- This command is only available when the Auto IP configuration mode or manual IP configuration mode is enabled.
- You are recommended to ask your network administrator for a gateway address available.
- The command has two optional parameters. Use "CURRent" to query the gateway address currently set (the [SYSTem:COMMunicate:LAN:UPDate](#) command is not executed). Use "STATic" to query the gateway address currently stored in the non-volatile memory (refer to [Appendix C: Non-volatile Memory](#)). When the parameter is omitted, the system queries the gateway address currently set.
- The default gateway is stored in the non-volatile memory (refer to [Appendix C: Non-volatile Memory](#)) and does not change when the power has been off, after a Factory Reset (send the [\\*RST](#) command) or after an Instrument Preset (send the [SYSTem:PRESet](#) command).

**Return Format** The query returns the current gateway address, for example, "172.16.3.4".

**Example** SYST:COMM:LAN:GATE "172.16.3.4"  
SYST:COMM:LAN:UPD  
SYST:COMM:LAN:GATE? STAT

The query returns "172.16.3.4".

**Related commands** [SYSTem:COMMunicate:LAN:MANUip](#)  
[SYSTem:COMMunicate:LAN:DNS](#)  
[SYSTem:COMMunicate:LAN:IPADdress](#)  
[SYSTem:COMMunicate:LAN:SMASK](#)

## SYSTem:COMMunicate:LAN:IPADdress

**Syntax** SYSTem:COMMunicate:LAN:IPADdress "<address>"  
 SYSTem:COMMunicate:LAN:IPADdress? [{CURRent|STATic}]

**Description** Set or query the IP address.

### Parameters

Name	Type	Range	Default
<address>	ASCII string	The format is nnn.nnn.nnn.nnn; the first nnn ranges from 1 to 223 (except 127), the other three range from 0 to 255.	None

- Explanation**
- This command is only available when the manual IP configuration mode is enabled.
  - You are recommended to ask your network administrator for an address available.
  - The command has two optional parameters. Use "CURRent" to query the IP address currently set (the [SYSTem:COMMunicate:LAN:UPDate](#) command is not executed). Use "STATic" to query the IP address currently stored in the non-volatile memory (refer to [Appendix C: Non-volatile Memory](#)). When the parameter is omitted, the system queries the IP address currently set.
  - The IP address is stored in the non-volatile memory (refer to [Appendix C: Non-volatile Memory](#)) and does not change when the power has been off, after a Factory Reset (send the [\\*RST](#) command) or after an Instrument Preset (send the [SYSTem:PRESet](#) command).

**Return Format** The query returns the current IP address, for example, "172.16.3.128".

**Example** SYST:COMM:LAN:IPAD "172.16.3.128"  
 SYST:COMM:LAN:IPAD? CURR  
 The query returns "172.16.3.128".

**Related commands** [SYSTem:COMMunicate:LAN:MANUip](#)  
[SYSTem:COMMunicate:LAN:DNS](#)  
[SYSTem:COMMunicate:LAN:GATEway](#)  
[SYSTem:COMMunicate:LAN:SMASK](#)

## SYSTem:COMMunicate:LAN:MAC?

**Syntax** SYSTem:COMMunicate:LAN:MAC?

**Description** Query the MAC address.

**Explanation** The MAC (Media Access Control) address is also called hardware address and is used to define the location of the network device. For a power supply, the MAC address is unique and is usually used to recognize the instrument when assigning IP address for the instrument. The MAC address (48 bits, namely 6 bytes) is usually expressed in hexadecimal form, for example, 00-EF-EE-17-03-30.

**Return Format** The query returns the MAC address, for example, 00-EF-EE-17-03-30.

**Example** SYST:COMM:LAN:MAC?  
 The query returns 00-EF-EE-17-03-30.

**Related command** [SYSTem Command Subsystem](#)



## SYSTem:COMMunicate:LAN:MANUip

**Syntax** SYSTem:COMMunicate:LAN:MANUip <mode>

SYSTem:COMMunicate:LAN:MANUip?

**Description** Enable or disable the manual IP configuration mode.

Parameters	Name	Type	Range	Default
	<mode>	Bool	ON OFF 0 1	ON

**Explanation**

- In manual IP configuration mode, users define the network parameters (such as the IP address).
- When all the three configuration modes are set to "On", the priority order of parameter configuration is "DHCP", "AutoIP" and "ManualIP".
- This setting takes effect after the [SYSTem:COMMunicate:LAN:UPDate](#) command (update the setting) is sent.
- The three IP configuration modes cannot all be set to "Off" at the same time.
- The manual IP configuration mode is stored in the non-volatile memory (refer to [Appendix C: Non-volatile Memory](#)) and does not change when the power has been off, after a Factory Reset (send the [\\*RST](#) command) or after an Instrument Preset (send the [SYSTem:PRESet](#) command).

**Return Format** The query returns 1 (ON) or 0 (OFF).

**Example** SYST:COMM:LAN:MANU ON  
SYST:COMM:LAN:MANU?

The query returns 1.

**Related commands**

- [SYSTem:COMMunicate:LAN:DHCP](#)
- [SYSTem:COMMunicate:LAN:AUTOip](#)
- [SYSTem:COMMunicate:LAN:DNS](#)
- [SYSTem:COMMunicate:LAN:GATEway](#)
- [SYSTem:COMMunicate:LAN:IPADdress](#)
- [SYSTem:COMMunicate:LAN:SMASK](#)

## SYSTem:COMMunicate:LAN:TELNet:PROMpt SYSTem:COMMunicate:LAN:TELNet:WMESsage

**Syntax** SYSTem:COMMunicate:LAN:TELNet:PROMpt "<string>"

SYSTem:COMMunicate:LAN:TELNet:PROMpt?

SYSTem:COMMunicate:LAN:TELNet:WMESsage "<string>"

SYSTem:COMMunicate:LAN:TELNet:WMESsage?

**Description** Set the command prompt and welcome message when a Telnet session is used to communicate with the instrument.

Parameters	Name	Type	Range	Default
	<string>	ASCII string	Up to 15 characters (prompt); Up to 63 characters (welcome message).	None

**Explanation** ➤ By now, the function of using Telnet session to communicate with the instrument is not

supported by M300, but you can still use these commands.

- The command prompt and welcome message are stored in the non-volatile memory (refer to [Appendix C: Non-volatile Memory](#)) and they do not change when the power has been off, after a Factory Reset (send the [\\*RST](#) command) or after an Instrument Preset (send the [SYSTem:PRESet](#) command).

**Return Format** The queries return strings enclosed in double quotation marks.

**Example** SYST:COMM:LAN:TELN:WMES "Welcome to Rigol Technologies' M300 Switch/Measure Unit"

SYST:COMM:LAN:TELN:WMES?

Typical Response: "Welcome to Rigol Technologies' M300 Switch/Measure Unit"

SYST:COMM:LAN:TELN:PROM "Command"

SYST:COMM:LAN:TELN:PROM?

The query returns "Command".

**Related command** [SYSTem Command Subsystem](#)

## SYSTem:COMMunicate:LAN:SMASK

**Syntax** SYSTem:COMMunicate:LAN:SMASK "<mask>"

SYSTem:COMMunicate:LAN:SMASK? [{CURRent|STATic}]

**Description** Set or query the subnet mask.

**Parameters**

Name	Type	Range	Default
<mask>	ASCII string	The format is nnn.nnn.nnn.nnn; wherein, the range of nnn is from 0 to 255.	None

- Explanation**
- This command is only available when the manual IP configuration mode is enabled.
  - You are recommended to ask your network administrator for a subnet mask available.
  - The command has two optional parameters. Use "CURRent" to query the subnet mask address currently set (the [SYSTem:COMMunicate:LAN:UPDate](#) command is not executed). Use "STATic" to query the subnet mask address currently stored in the non-volatile memory (refer to [Appendix C: Non-volatile Memory](#)). When the parameter is omitted, the system queries the subnet mask address currently set.
  - The subnet mask is stored in the non-volatile memory (refer to [Appendix C: Non-volatile Memory](#)) and does not change when the power has been off, after a Factory Reset (send the [\\*RST](#) command) or after an Instrument Preset (send the [SYSTem:PRESet](#) command).

**Return Format** The query returns the current subnet mask, for example, "255.255.255.0".

**Example** SYST:COMM:LAN:SMASK "255.255.255.0"  
SYST:COMM:LAN:SMASK? CURR

The query returns "255.255.255.0".

**Related commands** [SYSTem:COMMunicate:LAN:MANUip](#)  
[SYSTem:COMMunicate:LAN:DNS](#)  
[SYSTem:COMMunicate:LAN:GATEway](#)  
[SYSTem:COMMunicate:LAN:IPADdress](#)

## SYSTem:COMMunicate:LAN:UPDate

**Syntax** SYSTem:COMMunicate:LAN:UPDate

**Description** Update the LAN parameters. Disconnect all the LAN and Web connections and restart the LAN interface with the current LAN parameters.

**Explanation** ➤ Executing this command updates the settings of the following commands.

[SYSTem:COMMunicate:LAN:AUTOip](#)

[SYSTem:COMMunicate:LAN:DHCP](#)

[SYSTem:COMMunicate:LAN:MANUip](#)

[SYSTem:COMMunicate:LAN:DNS](#)

[SYSTem:COMMunicate:LAN:GATEway](#)

[SYSTem:COMMunicate:LAN:IPADdress](#)

➤ When the LAN parameters set are invalid, the LAN cannot be connected normally when this command is sent.

## SYSTem:COMMunicate:RS232:BAUD

**Syntax** SYSTem:COMMunicate:RS232:BAUD {4800|9600|19200|38400|57600|115200}

SYSTem:COMMunicate:RS232:BAUD?

**Description** Set or query the baud rate of the RS232 interface and the unit is Baud.

**Parameters**

Name	Type	Range	Default
{4800 9600 19200 38400 57600 115200}	Discrete	4800 9600 19200 38400 57600 115200	None

**Explanation** The baud rate of the RS232 interface is stored in the non-volatile memory (refer to [Appendix C: Non-volatile Memory](#)) and does not change when the power has been off, after a Factory Reset (send the [\\*RST](#) command) or after an Instrument Preset (send the [SYSTem:PRESet](#) command).

**Return Format** The query returns the current baud rate, for example, 19200.

**Example** SYST:COMM:RS232:BAUD 19200  
SYST:COMM:RS232:BAUD?

The query returns 19200.

**Related commands** [SYSTem:COMMunicate:RS232:FLOWcontrol](#)  
[SYSTem:COMMunicate:RS232:PARItY](#)  
[SYSTem:COMMunicate:RS232:PRINt:STATe](#)

## SYSTem:COMMunicate:RS232:FLOWcontrol

**Syntax** SYSTem:COMMunicate:RS232:FLOWcontrol  
{NONE|XON/XOFF|DTR/DSR|RTS/CTS|MODEm}

SYSTem:COMMunicate:RS232:FLOWcontrol?

**Description** Set or query the flow control mode of the RS232 interface.

**Parameters**

Name	Type	Range	Default
{NONE XON/XOFF DTR/DSR RTS/CTS MODEm}	Bool	NONE XON/XOFF DTR/DSR RTS/CTS MODEm	None

**Explanation** ➤ Please select the flow control mode that matches the computer or DTE.

### NONE

In this mode, the data is sent and received over the RS232 interface without any flow control used. When this mode is selected, please select relatively slower baud rate (lower than 9600 Baud) and please do not send data that is too long (longer than 128 characters) and does not contain end bit.

### XON/XOFF

This mode is software flow control mode. This mode uses special characters embedded in the data stream to control the flow. If the instrument is addressed to send data, it continues sending data until the "XOFF" (13H) string is received. When the "XON" (11H) string is received, the instrument resumes sending data.

### DTR/DSR

This mode is hardware flow control mode. The instrument monitors the state of the DSR pin. When the state goes "True", the instrument sends data over the interface. When the state goes "False", the instrument stops sending data. The instrument sets the DTR pin to "False" when the input buffer is almost full (approximately 100 characters) and sets the pin to "True" when space is available again.

### RTS/CTS

This mode is hardware flow control mode and it operates in the same way as the DTR/DSR mode. The instrument monitors the state of the CTS pin. When the state goes "True", the instrument sends data over the interface. When the state goes "False", the instrument stops sending data. The instrument sets the RTS pin to "False" when the input buffer is almost full (approximately 100 characters) and sets the pin to "True" when space is available again.

- The flow control mode of the RS232 interface is stored in the non-volatile memory (refer to [Appendix C: Non-volatile Memory](#)) and does not change when the power has been off, after a Factory Reset (send the [\\*RST](#) command) or after an Instrument Preset (send the [SYSTem:PRESet](#) command).

**Return Format** The query returns NONE,XON/XOFF,DTR/DSR,RTS/CTS or MODEM.

**Example** SYST:COMM:RS232:FLOW XON/XOFF  
SYST:COMM:RS232:FLOW?

The query returns XON/XOFF.

**Related commands**

[SYSTem:COMMunicate:RS232:BAUD](#)

[SYSTem:COMMunicate:RS232:PARItY](#)

[SYSTem:COMMunicate:RS232:PRINT:STATe](#)

## SYSTem:COMMunicate:RS232:PARItY

**Syntax** SYSTem:COMMunicate:RS232:PARItY {NONE|ODD|EVEN}

SYSTem:COMMunicate:RS232:PARItY?

**Description** Set the parity mode to "None", "Odd" or "Even".

Parameters	Name	Type	Range	Default
	{NONE ODD EVEN}	Discrete	NONE ODD EVEN	NONE

**Explanation** The parity mode of the RS232 interface is stored in the non-volatile memory (refer to [Appendix C: Non-volatile Memory](#)) and does not change when the power has been off, after a Factory Reset (send the [\\*RST](#) command) or after an Instrument Preset (send the [SYSTem:PRESet](#) command).

**Return Format** The query returns NONE, ODD or EVEN.

**Example** SYST:COMM:RS232:PARI ODD  
SYST:COMM:RS232:PARI?

The query returns ODD.

**Related commands** [SYSTem:COMMunicate:RS232:BAUD](#)  
[SYSTem:COMMunicate:RS232:FLOWcontrol](#)  
[SYSTem:COMMunicate:RS232:PRINt:STATe](#)

## SYSTem:COMMunicate:RS232:PRINt:STATe

**Syntax** SYSTem:COMMunicate:RS232:PRINt:STATe {ON|OFF|1|0}

SYSTem:COMMunicate:RS232:PRINt:STATe?

**Description** Enable or disable the function of outputting measurement data automatically via the RS232 interface.

Parameters	Name	Type	Range	Default
	{ON OFF 1 0}	Bool	ON OFF 1 0	None

**Explanation**

- After connecting the instrument and PC via the RS232 interface and enabling the print function, the instrument will output the measurement readings automatically through the RS232 interface when M300 is measuring. At this point, you can capture the readings using serial port data acquisition tool from the PC.
- The state of the function is stored in the non-volatile memory (refer to [Appendix C: Non-volatile Memory](#)) and does not change when the power has been off, after a Factory Reset (send the [\\*RST](#) command) or after an Instrument Preset (send the [SYSTem:PRESet](#) command)

**Return Format** The query returns 1 (ON) or 0 (OFF).

**Example** SYST:COMM:RS232:PRIN:STAT ON  
SYST:COMM:RS232:PRIN:STAT?

The query returns 1.

**Related commands** [SYSTem:COMMunicate:RS232:BAUD](#)  
[SYSTem:COMMunicate:RS232:FLOWcontrol](#)  
[SYSTem:COMMunicate:RS232:PARItY](#)

## SYSTem:CPON

**Syntax** SYSTem:CPON <slot>

**Description** Reset the module in the specified slot.

**Parameters**

Name	Type	Range	Default
<slot>	Discrete	{100 200 300 400 500 ALL}	None

**Explanation** ➤ The effect of this command on different module is follows.

Module	Effect
MC3120 MC3132 MC3164 MC3324	If any channel is configured into the scan list, this command has no effect. If no channel is configured into the scan list, this command opens all the channels.
MC3416	This command opens all the channels.
MC3534	For any channel that is configured into the scan list, this command has no effect. For channels that are not configured into the scan list, sending this command will set the DIO channels as 8-bit digital input port as well as restore the TOT and DAC channels to the factory state.
MC3648	This command opens all the channels.

- This command does not reset the DMM module.
- If the instrument is scanning or any channel of the specified module is added into the scan list, an error will be generated when sending this command.
- To reset the modules in all the five slots, set <slot> to ALL.

**Example** SYST:CPON 200

**Related commands** [\\*RST](#)  
[SYSTem:PRESet](#)

## SYSTem:CTYPe:DEFine

**Syntax** SYSTem:CTYPe:DEFine <Slot>|<Slot\_Type>,<ctype\_string>

SYSTem:CTYPe:DEFine? <Slot>

**Description** Reset the model string of the specified slot or specified type of module using the user-defined string (<ctype\_string>).

Query the user-defined model string of the specified slot.

**Parameters**

Name	Type	Range	Default
<Slot>	Discrete	{100 200 300 400 500}	None
<Slot_Type>	Discrete	{MC3132 MC3164 MC3120 MC3065 MC3416 MC3324 MC3648 MC3534}	None
<ctype_string>	ASCII String	Up to 128 characters (can be any character)	None

- Explanation**
- If <Slot>|<Slot\_Type> is a slot number (100|200|300|400|500), sending the SYSTem:CTYPe:DEFine <Slot>|<Slot\_Type>,<ctype\_string> command will only modify the model string of the specified slot.
  - If <Slot>|<Slot\_Type> is a module model number (MC3132|MC3164|MC3120|MC3065|MC3416|MC3324|MC3648|MC3534), sending the SYSTem:CTYPe:DEFine <Slot>|<Slot\_Type>,<ctype\_string> command will modify the model strings of the slots of all this type of modules in the instrument.
  - After executing the SYSTem:CTYPe:DEFine <Slot>|<Slot\_Type>,<ctype\_string> command, the query returns the user-defined model string of the specified slot when sending the [SYSTem:CTYPe?](#) command to query the model string of the module inserted into the specified slot.
  - If users do not reset the model string of the specified slot using the SYSTem:CTYPe:DEFine <Slot>|<Slot\_Type>,<ctype\_string> command, the return value is empty when using the SYSTem:CTYPe:DEFine? <Slot> command to query the model string of the specified slot; in addition, the query returns the default model string of the module (not affected by the user-defined model string of the slot) when using the [SYSTem:CTYPe?](#) Command to query the model string of the module inserted into the slot.
  - The user-defined model string of the specified slot specified using the SYSTem:CTYPe:DEFine <Slot>|<Slot\_Type>,<ctype\_string> command will overwrite the default model string of the module inserted into the specified slot. The user-defined model string of the slot will not be affected by a Factory Reset (send the [\\*RST](#) command) or an Instrument Preset (send the [SYSTem:PRESet](#) command). You can also send the [SYSTem:CTYPe:DEFault](#) command to set the model string of the module inserted into the specified slot to the default model string.

**Return Format** The query returns the current user-defined model string of the specified slot.

**Example** SYST:CTYP:DEF MC3120,MC3120\_1  
SYST:CTYP:DEF? 200

The query returns MC3120\_1.

## SYSTem:CTYPe:DEFault

**Syntax** SYSTem:CTYPe:DEFault <Slot>

**Description** Set the module model string to be determined by the default model string of the module currently inserted into the slot and be free from being affected by the user-defined model string of the slot.

Parameters	Name	Type	Range	Default
	<Slot>	Discrete	{100 200 300 400 500}	None

- Explanation**
- The format of the default model string of the module is as follows.  
RIGOL TECHNOLOGIES,MCXXXX,<serial number>,XX.XX.XX.XX  
Wherein, MCXXXX is the model number of the module; <serial number> is the serial number of the instrument and XX.XX.XX.XX is the software version number of the instrument.
  - After this command is executed, the module model string will not be affected by the user-defined model string of the its slot; namely, the query will return the default model string of the module when the [SYSTem:CTYPe?](#) command is sent to query the module model.

**Example** SYST:CTYP:DEF MC3132,MC3132\_1

SYST:CTYP:DEF 200

SYST:CTYP? 200

The query returns RIGOL TECHNOLOGIES,MC3132,MM3D000000000,00.01.01.01.

**Related command** [SYSTem:CTYPe:DEFine](#)

## SYSTem:CTYPe?

**Syntax** SYSTem:CTYPe? <slot>

**Description** Query the model string of the module inserted into the specified slot.

Parameters	Name	Type	Range	Default
	<slot>	Discrete	{100 200 300 400 500}	None

- Explanation**
- After the SYSTem:CTYPe:DEFine <Slot>|<Slot\_Type>,<ctype\_string> command is executed, the query will return the user-defined model string of the specified slot when this command is sent to query the model string of the module inserted into the specified slot.
  - If the model string of the specified slot is not reset by the SYSTem:CTYPe:DEFine <Slot>|<Slot\_Type>,<ctype\_string> command, the query will return the default model string of the module (not affected by the user-defined model string of the slot) when this command is sent to query the model string of the module inserted into the specified slot. If none module is inserted into the specified slot, the query returns RIGOL TECHNOLOGIES,0,0,0.

**Return Format** The query returns the user-defined model string of the specified slot or the default model string of the module.

The format of the default model string of the module is as follows.

RIGOL TECHNOLOGIES,MC3132,MM3D000000000,00.01.01.01

① Company Name    ② Module Model Number    ③ Serial Number    ④ Firmware Version

**Example** SYST:CTYP? 300

The query returns RIGOL TECHNOLOGIES,MC3324,MM3K000000000,00.01.01.01.

**Related commands** [SYSTem:CTYPe:DEFine](#)  
[SYSTem:CTYPe:DEFault](#)



## SYSTem:DATE

**Syntax** SYSTem:DATE <yyyy>,<mm>,<dd>

SYSTem:DATE?

**Description** Set or query the instrument date.

**Parameters**

Name	Type	Range	Default
<yyyy>	Integer	2001 to 2099	None
<mm>	Integer	01 to 12	None
<dd>	Integer	01 to 28, 29, 30 or 31 (related to the YYYY and MM currently set)	None

**Explanation**

- If you send a date with incorrect format (2013,13,01 or 2013,6,31 etc),the instrument will generate an error.
- The date setting is stored in the non-volatile memory (refer to [Appendix C: Non-volatile Memory](#)) and does not change when the power has been off, after a Factory Reset (send the **\*RST** command) or after an Instrument Preset (send the **SYSTem:PRESet** command).

**Return Format** The query returns three numbers separated by commas in the form of yyyy,mm,dd.

**Example** SYST:DATE 2013,8,12  
SYST:DATE?

The query returns 2013,8,12.

**Related commands** [SYSTem Command Subsystem](#)  
[SYSTem:TIME](#)

## SYSTem:EDITion?

**Syntax** SYSTem:EDITion?

**Description** Query the version of the M300 mainframe.

**Return Format** The query returns seven numbers separated by commas in the form of "XX.XX.XX.XX.XX.XX.XX".

**Example** SYST:EDIT?

The query returns 07.08.00.01.00.00.20

**Related command** [SYSTem:VERsion?](#)

## SYSTem:ERRor?

**Syntax** SYSTem:ERRor?

**Description** Read and clear an error from the error queue.

**Explanation**

- The instrument generates error message and beeps each time when a command syntax or hardware error is generated. "ERROR" will be displayed on the screen when the error queue is not empty.
- Up to 20 errors can be stored in M300. Errors are retrieved in first-in-first-out (FIFO) order. The error queue is cleared by the **\*CLS** command or when the power is cycled. Sending this command to read an error message will clear this error message.

- When error occurs, the corresponding bit in the status byte register will be set to 1.
- The error queue is not cleared by a Factory Reset (send the [\\*RST](#) command) or an Instrument Preset (send the [SYSTem:PRESet](#) command).

**Return Format** The query retruns the error number and error message enclosed in double quotation marks. The error string may contain up to 160 characters. For example, -224,"Illegal parameter value".

**Example** SYST:ERR?

The query retruns -224,"Illegal parameter value"

**Related command** [SYSTem Command Subsystem](#)

## SYSTem:IDN:USER:DEFine

**Syntax** SYSTem:IDN:USER:DEFine <idn\_string>

SYSTem:IDN:USER:DEFine?

**Description** Use the user-defined string <idn\_string> to reset the ID string of the instrument.

Query the current user-defined ID string of the instrument.

Parameters	Name	Type	Range	Default
	<idn_string>	ASCII string	Up to 128 characters, can be any character	None

- Explanation**
- If users do not use the SYSTem:IDN:USER:DEFine <idn\_string> command to reset the ID string of the instrument, the return value is empty when using the SYSTem:IDN:USER:DEFine? command to query the current user-defined ID string of the instrument.
  - The [\\*IDN?](#) command queries the current ID string of the instrument.
  - Sending the SYSTem:IDN:USER:DEFine <idn\_string> command to modify the ID string of the instrument will overwrite the default ID string of the instrument. A Factory Reset (send the [\\*RST](#) command) or Instrument Preset (send the [SYSTem:PRESet](#) command) does not affect the current ID string of the instrument. You can send the [SYSTem:IDN:DEFault](#) command to set the ID string of the instrument to the default.

**Return Format** The query returns the current user-defined ID string of the instrument.

**Example** SYST:IDN:USER:DEF M300\_1  
SYST:IDN:USER:DEF?

The query returns M300\_1.

## SYSTem:IDN:DEFault

**Syntax** SYSTem:IDN:DEFault

**Description** Set the ID string (include the manufacturer name, model and version number) of the instrument to its default.

- Explanation**
- The default ID string of the instrument is:  
RIGOL TECHNOLOGIES,M300,<serial number>,XX.XX.XX.XX.XX.XX  
Wherein, <serial number> is the serial number of the instrument and  
XX.XX.XX.XX.XX.XX is the software version number of the instrument.
  - The [\\*IDN?](#) command queries the current ID string of the instrument.

**Example** SYST:IDN:USER:DEF M300\_1  
SYST:IDN:DEF  
\*IDN?

The query returns RIGOL  
TECHNOLOGIES,M300,M300123123123,07.08.00.01.00.00.17.

**Related command** [SYSTem:IDN](#)

## SYSTem:LFRrequency?

**Syntax** SYSTem:LFRrequency?

**Description** Query the current power-line frequency of the instrument.

**Explanation** When you apply power to the instrument, the instrument automatically detects the power-line frequency and uses this value to calculate the power line cycles (1PLC=1/current power-line frequency).

**Return Format** The query returns "+50" (for the frequency outside the range of 55Hz to 66Hz) or "+60" (for 55Hz to 66Hz).

**Example** SYST:LFR?

The query returns +50.

**Related command** [SYSTem Command Subsystem](#)

## SYSTem:LOCal

**Syntax** SYSTem:LOCal

**Description** Place the instrument in the local mode.

- Explanation**
- If the instrument is in the remote or locked mode, you can send this command to place the instrument in the local mode.
  - In the local mode, all the keys on the front panel are fully functional.

**Example** SYST:LOC

**Related commands** [SYSTem:REMOte](#)  
[SYSTem:RWLock](#)

## SYSTem:OPENTimes?

**Syntax** SYSTem:OPENTimes?

**Description** Query the boot times of M300.

**Return Format** The query returns a positive integer.

**Example** SYST:OPEN?  
The query returns 41.

**Related command** [SYSTem Command Subsystem](#)

## SYSTem:PRESet

**Syntax** SYSTem:PRESet

**Description** Restore the instrument to the preset state.

**Explanation** Refer to [Appendix B: Instrument Preset State](#) for a complete listing of the preset states of the instrument.



**Example** SYST:PRES

**Related commands** [\\*RST](#)  
[SYSTem:CPON](#)

## SYSTem:REMOte

**Syntax** SYSTem:REMOte

**Description** Place the instrument in the remote mode.

**Explanation** In the remote mode, all the keys (except ,  and ) on the front panel are disabled.



**Example** SYST:REM

**Related commands** [SYSTem:LOCa](#)  
[SYSTem:RWLock](#)

## SYSTem:RWLock

**Syntax** SYSTem:RWLock

**Description** Place the instrument in the remote locked mode.

**Explanation** In the locked mode, all the keys (except ) on the front panel are disabled. You can press and hold  or send the [SYSTem:LOCa](#) command to unlock the instrument.

**Example** SYST:RWL

**Related command** [SYSTem:REMOte](#)

## SYSTem:SECurity[:IMMediate]

**Syntax** SYSTem:SECurity[:IMMediate]

**Description** Clear all the data (except the MAC address, calibration parameters and serial number) in the memory. This command usually restore the instrument to the initial state.

**Explanation**

- This command restore the instrument to the factory settings (refer to the [\\*RST](#) command).
- All the I/O parameters (such as the IP address) are returned to their factory settings.

- This command will not clear an attached USB storage device.
- The command clears and sanitizes all user files on the internal file system.

**Example** SYST:SEC

## SYSTEM:SERIAL?

**Syntax** SYSTEM:SERIAL?

**Description** Query the serial number of M300.

**Return Format** The query returns the serial number in the form of "M300XXXXXXXXX".

**Example** SYSTEM:SERIAL?

The query returns M300123123123.

**Related command** [SYSTEM Command Subsystem](#)

## SYSTEM:TIME

**Syntax** SYSTEM:TIME <hh>,<mm>,<ss.sss>

SYSTEM:TIME?

**Description** Set or query the instrument clock (based on a 24-hour clock).

**Parameters**

Name	Type	Range	Default
<hh>	Integer	Hour, an integer value between 0 and 23.	None
<mm>	Integer	Minute, an integer value between 0 and 59.	None
<ss.sss>	Integer	Second, an integer value between 0 and 60. Millisecond, an integer value between 0 and 999.	None

- Explanation**
- If you send a time with incorrect format (such as 26,30,23.000 or 23,30,64.000), the instrument will generate an error.
  - You can omit the millisecond of <ss.sss>, the instrument treated the millisecond as zero.
  - The time setting is stored in the non-volatile memory (refer to [Appendix C: Non-volatile Memory](#)) and does not change when the power has been off, after a Factory Reset (send the [\\*RST](#) command) or after an Instrument Preset (send the [SYSTEM:PRESet](#) command).

**Return Format** The query returns the time in the form of "hh,mm,ss.sss".

**Example** SYST:TIME 9,31,25.000  
SYST:TIME?

The query returns 09,31,26.000

**Related commands** [SYSTEM Command Subsystem](#)  
[SYSTEM:DATE](#)

## SYSTem:TIME:SCAN?

**Syntax** SYSTem:TIME:SCAN?

**Description** Query the start of the lastest scan.

- Explanation**
- You can query the start of the lastest scan, even during a scan.
  - The return format of this command is not affected by the [FORMat Command Subsystem](#) commands.
  - The instrument clears all the readings from the reading memory after a Factory Reset (send the [\\*RST](#) command), after an Instrument Preset (send the [SYSTem:PRESet](#) command) or when the mainframe power is cycled (the power-on value is set to "Default", refer to the [SYSTem:UTIlity:CONFIgure:POWEron](#) command).

**Return Format** The query returns the start of the lastest scan in the form of "yyyy,mm,dd,hh,mm,ss.sss".

**Example** SYST:TIME:SCAN?  
The query returns 2013,06,30,21,21,56.126.

**Related commands** [SYSTem:DATE](#)  
[SYSTem:TIME](#)

## SYSTem:TYPE?

**Syntax** SYSTem:TYPE?

**Description** Query the instrument model.

**Return Format** The query returns "M300".

**Example** SYST:TYPE?  
The query returns M300.

**Related commands** [SYSTem:EDITion?](#)  
[SYSTem:SERIal?](#)

## SYSTem:UTIlity:BEEPer:STATe

**Syntax** SYSTem:UTIlity:BEEPer:STATe ON|OFF|1|0  
SYSTem:UTIlity:BEEPer:STATe?

**Description** Enable or disable the beeper.

Parameters	Name	Type	Range	Default
	<state>	Bool	ON OFF 1 0	ON

- Explanation**
- When the beeper is enabled, the instrument generates prompt sound during front panel operation.
  - The instrument will enable the beeper after sending the [\\*RST](#) command.

**Return Format** The query returns 0 (OFF) or 1 (ON).

**Example** SYST:UTI:BEEP:STAT OFF  
SYST:UTI:BEEP:STAT?  
The query returns 0.

**Related command** [SYSTem Command Subsystem](#)

## SYSTem:UTIlity:CARDooperation

**Syntax** SYSTem:UTIlity:CARDooperation <REStart|CONFirm|IGNOre>

SYSTem:UTIlity:CARDooperation?

**Description** All the modules of M300 are not hot-swappable. To avoid damage caused by mis-operations (insert or plug the modules when the instrument is running), you can use this command to set the treatment of the mainframe when the modules are inserted or plugged.

Parameters	Name	Type	Range	Default
	<REStart CONFirm IGNOre>	Discrete	REStart CONFirm IGNOre	IGNOre

**Explanation**

- REStart: the instrument restarts automatically. If you insert a module during a scan, the instrument restarts and resumes the scan.
- CONFirm: prompt message is displayed. At this point, users need to confirm the module connection.
- IGNOre: the instrument does not execute any operation and recognize the module inserted automatically.

**Return Format** The query returns RESTART, CONFIRM or IGNORE.

**Example** SYST:UTI:CARD REST  
SYST:UTI:CARD?

The query returns RESTART.

**Related command** [SYSTem Command Subsystem](#)

## SYSTem:UTIlity:CONFigure:POWEron

**Syntax** SYSTem:UTIlity:CONFigure:POWEron LAST|DEF

SYSTem:UTIlity:CONFigure:POWEron?

**Description** Set or query the power-on value of the instrument.

Parameters	Name	Type	Range	Default
	{DEFault LAST}	Discrete	DEFault LAST	DEFault

**Explanation**

- LAST: the instrument uses the system configuration before the last power-off at power-on.
- DEFault: the instrument uses the factory settings (refer to [Appendix A: Factory](#)) at power-on, except those parameters (as shown below) that will not be affected by reset.
  - [1] Power Switch
  - [2] Language
  - [3] Module Plug
  - [4] I/O Configuration
- The power-on value of the instrument is set to "DEFault" after a Factory Reset (send the [\\*RST](#) command).

**Return Format** The query returns DEFAULT or LAST.

**Example** SYST:UTI:CONF:POWE LAST  
SYST:UTI:CONF:POWE?

The query returns LAST.

**Related command** [SYSTem Command Subsystem](#)

## SYSTem:UTIlity:DISPlay:BRIGht

**Syntax** SYSTem:UTIlity:DISPlay:BRIGht <value>

SYSTem:UTIlity:DISPlay:BRIGht?

**Description** Set or query the brightness of the screen.

Parameters	Name	Type	Range	Default
	<value>	Integer	0 to 15	8

**Explanation** The brightness of the screen is set to 8 after a Factory Reset (send the [\\*RST](#) command).

**Return Format** The query returns an integer from 0 to 15, for example, 5.

**Example** SYST:UTI:DISP:BRIG 10  
SYST:UTI:DISP:BRIG?

The query returns 10.

**Related command** [SYSTem Command Subsystem](#)

## SYSTem:UTIlity:FORMat:DECImal

**Syntax** SYSTem:UTIlity:FORMat:DECImal COMMA|DOT

SYSTem:UTIlity:FORMat:DECImal?

**Description** Set the display form of the decimal point of the screen data to "." or ",".

Parameters	Name	Type	Range	Default
	{COMMA DOT}	Discrete	COMMA DOT	DOT

**Explanation** ➤ The decimal pint is set to dot after a Factory Reset (send the [\\*RST](#) command).

**Return Format** The query returns COMMA (",") or DOT (".").

**Example** SYST:UTI:FORM:DECI COMMA  
SYST:UTI:FORM:DECI?

The query returns COMMA.

**Related commands** [SYSTem Command Subsystem](#)  
[SYSTem:UTIlity:FORMat:SEPARate](#)



## SYSTem:UTIlity:FORMat:SEPArate

**Syntax** SYSTem:UTIlity:FORMat:SEPArate ON|NONE|SPACE

SYSTem:UTIlity:FORMat:SEPArate?

**Description** Set the display form of the separator of the screen data to ",", ".", "None" or "Space".

**Parameters**

Name	Type	Range	Default
{ON NONE SPACE}	Discrete	ON NONE SPACE	None

**Explanation** > The display form of the decimal point affects the display form of the separator. The two cannot be set to "." or "," at the same time. There are 6 kinds of data formats.

Decimal Point	Separator	Example
.	,	10.000,00
.	Space	10.000 00
.	None	10.00000
,	.	10,000.00
,	Space	10,000 00
,	None	10,00000

> The separator is set to none after a Factory Reset (send the [\\*RST](#) command).

**Return Format** The query returns ON, NONE or SPACE.

**Example** SYST:UTI:FORM:SEPA ON  
SYST:UTI:FORM:SEPA?

The query returns ON.

**Related commands** [SYSTem Command Subsystem](#)  
[SYSTem:UTIlity:FORMat:DECIml](#)

## SYSTem:UTIlity:LANGUage

**Syntax** SYSTem:UTIlity:LANGUage CH|EN

SYSTem:UTIlity:LANGUage?

**Description** Set the system language to English or Chinese.

**Parameters**

Name	Type	Range	Default
{EN CH}	Discrete	EN CH	None

**Return Format** The query returns English or Simplified Chinese.

**Example** SYST:UTI:LANG EN  
SYST:UTI:LANG?

The query returns English.

**Related command** [SYSTem Command Subsystem](#)

## SYSTem:UTIlity:POWER:SWITCh:STATe

**Syntax** SYSTem:UTIlity:POWER:SWITCh:STATe ON|OFF|1|0

SYSTem:UTIlity:POWER:SWITCh:STATe?

**Description** Set or query the status of the power switch.

Parameters	Name	Type	Range	Default
	{ON OFF 1 0}	Discrete	ON OFF 1 0	OFF

- Explanation**
- ON: the front panel power key is invalid. After power-on, the instrument starts automatically. You can still press the front panel power key to turn off the instrument.
  - OFF: the front panel power key is valid. You have to press the front panel power key to start the instrument after power-on.
  - The power switch is set to off after a Factory Reset (send the [\\*RST](#) command).

**Return Format** The query returns 0 (OFF) or 1 (ON).

**Example** SYST:UTI:POWE:SWIT:STAT ON  
SYST:UTI:POWE:SWIT:STAT?

The query returns 1.

**Related command** [SYSTEM Command Subsystem](#)

## SYSTEM:UTILITY:SAVER:STATE

**Syntax** SYSTEM:UTILITY:SAVER:STATE <state>  
SYSTEM:UTILITY:SAVER:STATE?

**Description** Enable or disable the screen saver function.

Parameters	Name	Type	Range	Default
	<state>	Bool	{ON OFF 1 0}	OFF

- Explanation**
- The screen saver function will be disabled after a Factory Reset (send the [\\*RST](#) command).

**Return Format** The query returns 0 (OFF) or 1 (ON).

**Example** SYST:UTI:SAVE:STAT ON  
SYST:UTI:SAVE:STAT?

The query returns 1.

**Related commands** [SYSTEM Command Subsystem](#)  
[SYSTEM:UTILITY:SAVER:TIME](#)

## SYSTEM:UTILITY:SAVER:TIME

**Syntax** SYSTEM:UTILITY:SAVER:TIME <time>  
SYSTEM:UTILITY:SAVER:TIME?

**Description** Set or query the idle time of the instrument before entering the screen saver mode.

Parameters	Name	Type	Range	Default
	<time>	Integer	1 to 60, the unit is minute.	None

- Explanation**
- If you stop operating the instrument for the specified screen saver time, the instrument automatically enters the screen saver mode (the screen saver function was enabled). Send the SYSTEM:UTILITY:SAVER:STATE or press any key at the front panel to disable the screen saver function.

- The screen saver function will be disabled after a Factory Reset (send the [\\*RST](#) command).

**Return Format** The query returns an integer from 1 to 60, for example, 5.

**Example** SYST:UTI:SAVE:TIME 10  
SYST:UTI:SAVE:TIME?

The query returns 10.

**Related commands** [SYSTem Command Subsystem](#)  
[SYSTem:UTIlity:SAVEr:STATe](#)

## SYSTem:VERSion?

**Syntax** SYSTem:VERSion?

**Description** Query the version of the SCPI command set.

**Return Format** The query returns 1999.0

**Example** SYST:VERS?  
The query returns 1999.0.

**Related command** [SYSTem:EDITion?](#)

## TRIGger Command Subsystem

- [TRIGger:ABSolute](#)
- [TRIGger:COUNt](#)
- [TRIGger:EDGE](#)
- [TRIGger:SOURce](#)
- [TRIGger:TIMer](#)

### TRIGger:ABSolute

**Syntax** TRIGger:ABSolute <mm>,<dd>,<hh>,<mm>,<ss>  
TRIGger:ABSolute?

**Description** Set the time at which the instrument starts scanning in the absolute time trigger mode.

Parameters	Name	Type	Range	Default
	<mm>	Integer	1 to 12.	None
	<dd>	Integer	01 to 28, 29, 30 or 31 (related to <mm> currently set).	None
	<hh>	Integer	0 to 23.	None
	<mm>	Integer	0 to 59.	None
	<ss>	Integer	0 to 59.	None

- Explanation**
- The instrument triggers when the system time reaches the time specified in this command in absolute time trigger mode (refer to the [TRIGger:SOURce](#) command).
  - The instrument can also ignore some time parameters and trigger when the system time fulfills some of the parameters. Replace the parameters to be ignored with \* when sending the command. For example, to set the instrument to ignore the "Month" and "Date" and trigger at 8:00 every day, send the [TRIG:ABS \\*,\\*,8,0,0](#) command.
  - When all the parameters in the command are set to \*, they will all be ignored and the trigger mode is similar to the auto trigger mode.

**Return Format** The query returns <mm>,<dd>,<hh>,<mm>,<ss>. For example: 01,21,08,00,00 represents 8:0:0 on January 21. The parameters to be ignored are replaced with \*. For example, \*,\*,8,0,0; "Month" and "Date" are ignored and the instrument triggers at 8:00 every day.

**Example** TRIG:ABS 1,21,8,0,0  
TRIG:ABS?  
The query returns 01,21,08,00,00

**Related command** [TRIGger:SOURce](#)

## TRIGger:COUNT

**Syntax** TRIGger:COUNT {<count>|MIN|MAX|INFINITY}  
TRIGger:COUNT?

**Description** Set the number of scans.

Parameters	Name	Type	Range	Default
	<count>	Integer	Any integer from 1 to 50000 (MAX) or INFINITY.	1

- Explanation**
- When the number of scans is set to a specific value, the instrument stops automatically when the specified number of scans are finished.
  - After setting the number of scans, in the instrument can only receive trigger signals (refer to the [TRIGger:SOURce](#) command) effectively when it is in the "wait-for-trigger" state (send the [INITiate](#) or [READ?](#) command).  
  
In the BUS (manual) trigger mode, <count> determines the number of the [\\*TRG](#) commands that can be effectively accepted by the instrument. Once the instrument is in the "Idle" state, sending the [\\*TRG](#) command cannot trigger a scan.  
  
In the EXTERNAL (external) trigger mode, <count> determines the number of external signals that can be effectively accepted by the instrument. Once the instrument is in the "Idle" state, inputting a valid trigger signal cannot trigger a scan.
  - The [CONFigure Command Subsystem](#) and [MEASure Command Subsystem](#) commands automatically set the number of scans to 1.
  - You can set the number of scans to INFINITY, the instrument scans continuously. At this point, you can send the [ABORT](#) command to stop the scan.
  - The instrument sets the number of scans to 1 after a Factory Reset (send the [\\*RST](#) command). An Instrument Preset (send the [SYSTem:PRESet](#) command) or Card Reset (send the [SYSTem:CPON](#) command) does not affect the current setting.

**Return Format** The query returns the number of scans in scientific notation. When the number of scans is set to INFINITY, the query returns 9.90000200E+37.

**Example** CONF:VOLT:DC 20,0.001,(@103:108)  
ROUT:SCAN (@103:108)  
TRIG:COUN 6  
INIT  
TRIG:COUN?

The query returns +6.000000000E+00.

**Related command** [TRIGger Command Subsystem](#)

## TRIGger:EDGE

**Syntax** TRIGger:EDGE {RISing|FALLing}  
TRIGger:EDGE?

**Description** Set the edge type of the external trigger input signal when the instrument initiate a trigger in the external trigger mode.

Parameters	Name	Type	Range	Default
	{RISing FALLing}	Discrete	RISing FALLing	RISing

**Explanation**

- When the DMM module is disabled (refer to the [INSTrument:DMM](#) command) or is not installed, use the [ROUTE:CHANnel:ADVance:EDGE](#) command to set the edge type in the external trigger. In this case, using this command to set the edge type in the external trigger will generate an error.
- The pulse width of the external trigger input signal must be greater than or equal to 2μs and the pulse period must be greater than 100μs.
- The instrument is set to initiate the trigger on the rising edge type of the external trigger input signal in the external trigger mode after a Factory Reset (send the [\\*RST](#) command). An Instrument Preset (send the [SYSTem:PRESet](#) command) or Card Reset (send the [SYSTem:CPON](#) command) does not affect the setting.

**Return Format** The query returns RIS or FALL.

**Example** TRIG:EDGE FALL  
TRIG:EDGE?

The query returns FALL.

**Related command** [TRIGger:SOURce](#)

## TRIGger:SOURce

**Syntax** TRIGger:SOURce <source>

TRIGger:SOURce?

**Description** Set the trigger mode to auto, manual, external, absolute time or alarm.

**Parameters**

Name	Type	Range	Default
<source>	Discrete	{IMMEDIATE TIMER BUS EXTERNAL ALARM1 ALARM2 ALARM3 ALARM4 ABSOLUTE}	IMMEDIATE

**Explanation**

- IMMEDIATE: auto (continuous)  
 TIMER: auto (scan interval)  
 BUS: manual  
 EXTERNAL: external  
 ABSOLUTE: absolute time  
 ALARM1|ALARM2|ALARM3|ALARM4: alarm
- In the IMMEDIATE trigger mode, the trigger condition is always satisfied. Once the instrument is in the "wait-for-trigger" state, the trigger is issued immediately.
- In the TIMER mode, the instrument waits for the specified interval (send the [TRIGger:TIMER](#) command) and then performs the next scan after the current scan is finished.
- In the BUS trigger mode and when the instrument is in the "wait-for-trigger" state (send the [INITiate](#) or [READ?](#) command), the instrument generates a trigger (measures all the channels in the scan list and then wait for the next trigger) each time the [\\*TRG](#) command is received. You cannot read the readings using the [READ?](#) command or any other query command (it is called the "Trigger Dead Area").
- To use the external trigger mode, convert the **[RS-232/Alarms/Ext Trig]** interface at the rear panel to two 9-pin interfaces using the mixed-interface separator line (MIX-SEPARATOR accessory). Wherein, the 9-pin male interface is a standard RS232 interface and the 9-pin female interface is used for alarm output, external trigger signal input (pin 6, as shown in the figure below) and so on. In the external trigger mode, the instrument initiates a trigger when a TTL pulse (the edge is set by the [TRIGger:EDGE](#) command, the pulse width is greater than 2µs and the pulse period must be greater than 100µs) is received at the external trigger signal input terminal.

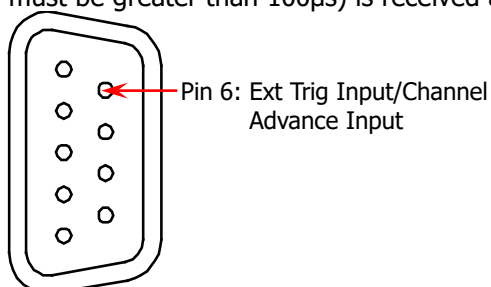

Alarm/Ext Trig interface

- In the absolute time trigger mode, the instrument triggers when the instrument system time (determined by the [SYSTEM:DATE](#) and [SYSTEM:TIME](#) commands) reaches the specified time (determined by the [TRIGger:ABSOLUTE](#) command).
- In the alarm trigger mode, the instrument triggers when alarm occur on the specified alarm channel.
- To trigger when the trigger condition is met, the instrument must be in the "wait-for-trigger" state (send the [INITiate](#) or [READ?](#) command).
- The [CONFigure Command Subsystem](#) and [MEASure Command Subsystem](#) commands automatically set the trigger mode to IMMEDIATE.

- The trigger mode is set to IMMEDIATE (auto) automatically after a Factory Reset (send the [\\*RST](#) command). An Instrument Preset (send the [SYSTem:PRESet](#) command) or Card Reset (send the [SYSTem:CPON](#) command) does not affect the setting.

**Return Format** The query returns BUS, IMM, EXT, ALAR1, ALAR2, ALAR3, ALAR4 or ABS.

**Example** TRIG:SOUR ABS  
TRIG:SOUR?  
The query returns ABS.

## TRIGger:TIMER

**Syntax** TRIGger:TIMER {<seconds>|MIN|MAX}  
TRIGger:TIMER? [{MIN|MAX}]

**Description** Set the scan interval in the TIMER trigger mode.

Parameters	Name	Type	Range	Default
	<seconds>	Numeric	0 to 359999.999s	0

**Explanation** ➤ The time interval defines the time from the start of a scan to the start of the next scan in the auto scan mode, as shown below.

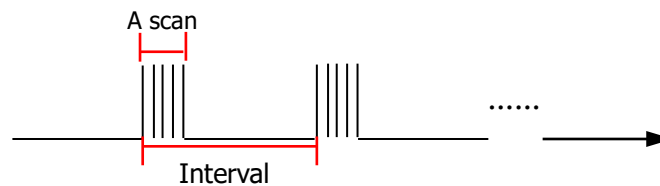

- If the scan interval specified is shorter than the time required to perform a complete scan of the scan list, the instrument will scan continuously as fast as possible (no error is generated).
- Send the TRIG:TIM? MIN command to query the minimum interval and the query returns +0.000000000E+00. Send the TRIG:TIM? MAX command to query the maximum interval and the query returns +3.599999990E+05.
- The [CONFigure Command Subsystem](#) and [MEASure Command Subsystem](#) commands automatically set the scan interval to 0.
- The instrument sets the scan interval to 0 after a Factory Reset (send the [\\*RST](#) command). An Instrument Preset (send the [SYSTem:PRESet](#) command) or Card Reset (send the [SYSTem:CPON](#) command) does not affect the setting.

**Return Format** The query returns the current scan interval in scientific notation, for example, +3.600000000E+04. The unit is s.

**Example** TRIG:TIM 36000  
TRIG:TIM?  
The query returns +3.600000000E+04.

**Related command** [TRIGger:SOURce](#)



## UNIT Command Subsystem

- [UNIT:ANYSensor](#)
- [UNIT:TEMPerature](#)

### UNIT:ANYSensor

**Syntax** UNIT:ANYSensor <units>[,(@<ch\_list>)]  
 UNIT:ANYSensor? [(@<ch\_list>)]

**Description** Select the unit for the specified anysensor measurement channels.

**Parameters**

Name	Type	Range	Default
<units>	Discrete	{Ω K #C % #F # ASCII String} Wherein, "#" represents the degree symbol (°); a quoted ASCII string of up to three characters. You can use English uppercase/lowercase letters (A-Z, a-z) or numbers (0-9). The first character can not be a number.	None
<ch_list>	Channel List	One or more channels (only for the multiplexer channels), the rules are as follows:  (@101):channel 01 on the module in Slot1; (@101:103):channel 01 through 03 on the module in Slot1; (@101:103,301,406:408):channel 01 through 03 on the module in Slot1, channel 01 on the module in Slot3 and channel 06 through 08 on the module in Slot4.	If the parameter is omitted, this command will be applied to the whole scan list.

- Explanation**
- If the measurement function of the specified channel is not anysensor, the instrument will generate an error.
  - This command will affect the unit of the readings when storing them.
  - If <units> is specified as an ASCII string, the instrument will set the unit in "user-defined" mode.
  - The [CONFigure Command Subsystem](#) and [MEASure Command Subsystem](#) commands automatically select to set the unit in "user-defined" mode.
  - The instrument select to set the unit in "user-defined" mode after a Factory Reset (send the [\\*RST](#) command). An Instrument Preset (send the [SYSTEM:PRESet](#) command) or Card Reset (send the [SYSTEM:CPON](#) command) does not affect the setting.

**Return Format** The query returns "Ω", "K", "C", "%", "F", "#" or a quoted ASCII string for each specified channel. Multiple return values are separated by commas.

**Example** UNIT:ANYS "K",(@101)  
 UNIT:ANYS? (@101)

The query returns "K".

**Related commands** [CONFigure:ANYSensor](#)  
[MEASure:ANYSensor?](#)

## UNIT:TEMPerature

**Syntax** UNIT:TEMPerature <units>[,(@<ch\_list>)]

UNIT:TEMPerature? [(@<ch\_list>)]

**Description** Set the unit of the temperature measurement on the specified channels.

Query the unit of the temperature measurement on the specified channels.

### Parameters

Name	Type	Range	Default
<units>	Discrete	{C F K}	None
<ch_list>	Channel List	One or more channels (only for the multiplexer channels), the rules are as follows:  (@101):channel 01 on the module in Slot1; (@101:103):channel 01 through 03 on the module in Slot1; (@101:103,301,406:408):channel 01 through 03 on the module in Slot1, channel 01 on the module in Slot3 and channel 06 through 08 on the module in Slot4.	If the parameter is omitted, this command will be applied to the whole scan list.

- Explanation**
- This command will affect the unit of the readings when storing them.
  - If the measurement function of the specified channel is not temperature, the instrument will generate an error.
  - Setting the  $A*(x-x1)^2+B*(x-x1)+C$  (refer to the [CALCulate:SCALE:UNIT](#) command) scaling units has no effect on the temperature measurement units currently selected.
  - The [CONFigure Command Subsystem](#) and [MEASure Command Subsystem](#) commands automatically select to set the unit of the specified temperature measurement channels to °C.
  - The instrument sets the unit of the specified temperature measurement channels to °C after a Factory Reset (send the [\\*RST](#) command). An Instrument Preset (send the [SYSTem:PRESet](#) command) or Card Reset (send the [SYSTem:CPON](#) command) does not affect the setting.

**Return Format** The query returns C, F, or K for each channel specified. Multiple return values are separated by commas.

**Example** CONF:TEMP TC,K,(@201,205)  
 UNIT:TEMP F,(@201,205)  
 UNIT:TEMP? (@201,205)

The query returns F,F.

**Related commands** [CONFigure:TEMPerature](#)  
[MEASure:TEMPerature?](#)

## Chapter 3 Application Examples

This chapter provides some application examples of the SCPI commands. A series of SCPI commands are combined to realize the main functions of the Data Acquisition/Switch System.

### Note:

- 1 Before using the examples in this chapter, please select the desired communication interface (USB, LAN, RS232 or GPIB) and make correct connections (refer to the introductions in [To Build Remote Communication](#)). Besides, you have to install Ultra Sigma or other PC software for sending commands on your PC.
- 2 The content enclosed in "/"\* and "\*" /" after each command is annotation for easier understanding and is not a part of the command.

### Main topics of this chapter:

- [Scan List Configuration](#)
- [Monitor](#)
- [Store and Recall](#)
- [Copy](#)
- [To Output](#)
- [To Output Analog Voltage](#)

## Scan List Configuration

### To Configure the Channels

#### Conditions:

MC3324 module in Slot1

MC3132 module in Slot2

MC3534 module in Slot3

MC3065 module in Slot4

MC3648 module in Slot5

#### Requirements

Use the SCPI commands to realize the following functions:

Configure the channels as follows and add these channels to the scan list to measure a variety of input signals.

Channel	Configuration	
	Measurement Function	Parameter
101	Temperature, RTD, 85	Integration time: 10PLC; R0=50Ω;
102	VOLTage:DC	Range: AUTO; Integration time: 100PLC; Enable the input resistance mode; Scaling: A=1.001, B=1.1, C=0.01, x1=0.05; Alarm setting: HI=10V, LO=0.7V, alarm channel (Alarm1);
103:105	VOLTage:AC	Range: 20V; AC Filter: 3Hz; Alarm setting: HI=5V, alarm channel (Alarm2);
106	Temperature, FRTD, 92	Integration time: 200PLC; Enable the offset compensation function; R0=50Ω;
107:110	Frequency	Voltage range: AUTO; Gate time: 10ms; Alarm setting: HI=3kHz, alarm channel (Alarm4);
111:112	Period	Voltage range: 300V; AC Filter: 200Hz;
113	Temperature, TC, J	Integration time: 0.5ms; unit: F Scaling: A=1.001, B=1.1, C=0.01, x1=0.01; Alarm setting: HI=30F, alarm channel (Alarm1); Reference source: external; Enable Auto Zero; Enable T/C Check;
114	Temperature, THER, 5000	Integration time: 2PLC; Enable Auto Zero; Alarm setting: LO=10°C, alarm channel (Alarm2) ;
115	Temperature,RTD,91	Integration time: 20PLC; R0=50Ω;
119	Temperature,TC,K	Alarm setting: LO=10°C, alarm channel (Alarm3) ; Reference source: internal;
120	Temperature,TC,S	Reference source: fixed;
121:122	CURRent:DC	Range: AUTO; Integration time: 1ms; Alarm setting: HI=0.6A, alarm channel (Alarm4) ;
123	CURRent:AC	Range: 1A; AC Filter: 3Hz; Channel delay: 1ms;
124	Anysensor:CURRent	
201	Anysensor:VOLTage	Integration time: 3ms; Unit: mV Scaling: A=1.001, B=1.1, C=0.01, x1=0.03;
202	Anysensor:Resistance	Enable Auto Zero;
203	Anysensor:FResistance	Alarm setting: LO=1kΩ, alarm channel (Alarm1); Enable the offset compensation function;
204	Anysensor:Frequency	
301	DIN:8bit	Level type: TTL; Alarm setting: DATA=154, MASK=129, TYPE=EQU, alarm channel (Alarm2) ;
303	DIN:16bit	Alarm setting: DATA=121, MASK=5, TYPE=NEQU, alarm

		channel (Alarm3); Level type: USER; Voltage level: 5V; THReshold: 3.5V;
305	TOT:READ	Alarm setting: HI=1000, alarm channel (Alarm4); Slop: NEGtive;
307	TOT:RREse	Slop: POStive; Threshold: 5V;

**Method 1**

1. \*IDN? /\*Query the ID string of M300 to check whether the remote communication is normal\*/
2. FUNC "TEMP",(@101) /\*Configure the function to temperature for channel 101\*/
3. TEMP:TRAN:TYPE RTD,(@101) /\*Set the temperature sensor type to RTD for channel 101\*/
4. TEMP:TRAN:RTD:TYPE 85,(@101) /\*Set the RTD type to 85 for channel 101\*/
5. TEMP:NPLC 10,(@101) /\*Set the integration time to 10PLC for channel 101\*/
6. TEMP:TRAN:RTD:RES:REF 50,(@101)/\*Set R0 to 50Ω for channel 101\*/
  
7. FUNC "VOLT:DC",(@102) /\*Configure the function to DCV for channel 102\*/
8. VOLT:DC:RANG:AUTO ON,(@102) /\*Enable the autoranging for channel 102\*/
9. CALC:SCAL:SQU 1.001,(@102) /\*Set scaling parameter A to 1.001 for channel 102\*/
10. CALC:SCAL:GAIN 1.1,(@102) /\* Set scaling parameter B to 1.1 for channel 102\*/
11. CALC:SCAL:OFFS 0.01,(@102) /\*Set scaling parameter C to 0.01 for channel 102\*/
12. CALC:SCAL:CONS 0.05,(@102) /\*Set scaling parameter x1 to 0.05 for channel 102\*/
13. CALC:SCAL:STAT ON,(@102) /\*Enable the scaling function for channel 102\*/
14. CALC:LIM:UPP 10,(@102) /\*Set the alarm upper limit to 10V for channel 102\*/
15. CALC:LIM:UPP:STAT ON,(@102) /\*Enable the upper limit alarm for channel 102 \*/
16. CALC:LIM:LOW 0.7,(@102) /\*Set the alarm lower limit to 0.7V for channel 102\*/
17. CALC:LIM:LOW:STAT ON,(@102) /\*Enable the lower limit alarm for channel 102\*/
18. OUTP:ALAR1:SOUR (@102) /\*Set the alarm channel to Alarm1 for channel 102\*/
19. VOLT:DC:NPLC 100,(@102) /\* Set the integration time to 100PLC for channel 102\*/
20. INP:IMP:AUTO ON,(@102) /\*Enable the input impedance function for channel 102\*/
  
21. FUNC "VOLT:AC",(@103,104,105) /\*Configure the function to ACV for channels 103, 104, and 105.\*/\*
22. VOLT:AC:RANG 20,(@103,104,105) /\*Select the 20V range for channels 103, 104, and 105.\*/\*
23. CALC:LIM:UPP 5,(@103,104,105) /\*Set the alarm upper limit to 5V for channels 103, 104, and 105.\*/\*
24. CALC:LIM:UPP:STAT ON,(@103,104,105) /\*Enable the upper limit alarm for channels 103, 104, and 105.\*/\*
25. OUTP:ALAR2:SOUR (@103,104,105) /\*Set the alarm channel to Alarm2 for channels 103, 104, and 105.\*/\*
26. VOLT:AC:BAND 3,(@103,104,105) /\*Select the 3Hz AC filter for channels 103, 104, and 105.\*/\*
  
27. FUNC "TEMP",(@106) /\*Configure the function to temperature for channel 106\*/
28. TEMP:TRAN:TYPE FRTD,(@106) /\*Set the temperature sensor type to FRTD for channel 106\*/
29. TEMP:TRAN:FRTD:TYPE 92,(@106) /\* Set the FRTD type to 92 for channel 106\*/
30. TEMP:NPLC 200,(@106) /\*Set the integration time to 200NPLC for channel 106\*/
31. TEMP:TRAN:FRTD:RES:REF 20,(@106)/\*Set R0 to 20Ω for channel 106\*/
32. TEMP:TRAN:FRTD:OCOM ON (@106) /\*Enable the offset compensation function for channel 106\*/
  
33. FUNC "FREQ",(@107:110) /\*Configure the function to frequency for channel 107-110\*/
34. FREQ:VOLT:RANG:AUTO ON,(@107:110) /\*Enable the autoranging for channel 107-110\*/
35. CALC:LIM:UPP 3000,(@107:110) /\*Set the alarm upper limit to 3kHz for channel 107-110\*/
36. CALC:LIM:UPP:STAT ON,(@107:110) /\*Enable the upper limit alarm for channel 107-110\*/
37. OUTP:ALAR4:SOUR (@107:110) /\*Set the alarm channel to Alarm4 for channel 107-110\*/
38. FREQ:RANG:APER 1E-01,(@107:110) /\*Set the gate time to 0.1s for channel 107-110\*/
  
39. FUNC "PER",(@111,112) /\*Configure the function to period for channels 111 and 112\*/
40. PER:VOLT:RANG 300,(@111,112) /\*Select the 300V range for channels 111 and 112\*/

41. PER:RANG:LOW 200,(@111,112) /\*Select the 200Hz AC filter for channels 111 and 112\*/
42. FUNC "TEMP",(@113) /\*Configure the function to temperature for channel 113\*/
43. TEMP:TRAN:TYPE TC,(@113) /\*Set the temperature sensor type to TC for channel 113\*/
44. TEMP:TRAN:TC:TYPE J,(@113) /\* Set the TC type to J for channel 113\*/
45. UNIT:TEMP F,(@113) /\*Set the unit to °F for channel 113\*/
46. CALC:SCAL:SQU 1.001,(@113) /\*Set scaling parameter A to 1.001 for channel 113\*/
47. CALC:SCAL:GAIN 1.1,(@113) /\*Set scaling parameter B to 1.1 for channel 113\*/
48. CALC:SCAL:OFFS 0.01,(@113) /\*Set scaling parameter C to 0.01 for channel 113\*/
49. CALC:SCAL:CONS 0.1,(@113) /\*Set scaling parameter x1 to 0.01 for channel 113\*/
50. CALC:SCAL:STAT ON,(@113) /\*Enable the scaling function for channel 113\*/
51. CALC:LIM:UPP 30,(@113) /\*Set the alarm upper limit to 30°F for channel 113\*/
52. CALC:LIM:UPP:STAT ON,(@113) /\*Enable the upper limit alarm for channel 113\*/
53. OUTP:ALAR1:SOUR (@113) /\*Set the alarm channel to Alarm1 for channel 113\*/
54. TEMP:APER 0.0005,(@113) /\*Set the integration time to 0.5ms for channel 113\*/
55. TEMP:TRAN:TC:CHEC ON,(@113) /\*Enable the T/C Check feature for channel 113\*/
56. ROUT:SCAN (@101) /\*Add channel 101 to the scan list\*/
57. TEMP:TRAN:TC:RJUN:TYPE EXT,(@113) /\*Set the reference source to external for channel 113 \*/
58. ZERO:AUTO ON,(@113) /\*Enable the auto zero function for channel 113\*/
59. FUNC "TEMP",(@114) /\*Configure the function to temperature for channel 114\*/
60. TEMP:TRAN:TYPE THER,(@114) /\*Set the temperature sensor type to thermistors for channel 114\*/
61. TEMP:TRAN:THER:TYPE 5000,(@114) /\* Set the THER type to 5000 for channel 114 \*/
62. CALC:LIM:LOW 10,(@114) /\*Set the alarm lower limit to 10°C for channel 114\*/
63. CALC:LIM:LOW:STAT ON,(@114) /\*Enable the lower limit alarm for channel 114\*/
64. OUTP:ALAR2:SOUR (@114) /\*Set the alarm channel to Alarm2 for channel 114\*/
65. TEMP:NPLC 2,(@114) /\*Set the integration time to 2PLC for channel 114\*/
66. ZERO:AUTO ON,(@114) /\*Enable the auto zero function for channel 114\*/
67. FUNC "TEMP",(@115) /\*Configure the function to temperature for channel 115\*/
68. TEMP:TRAN:TYPE RTD,(@115) /\*Set the temperature sensor type to RTD for channel 115\*/
69. TEMP:TRAN:RTD:TYPE 91,(@115) /\*Set the RTD type to 91 for channel 115\*/
70. TEMP:NPLC 20,(@115) /\*Set the integration time to 20PLC for channel 115\*/
71. TEMP:TRAN:RTD:RES:REF 50,(@115)/\*Set R0 to 50Ω for channel 115\*/
72. FUNC "TEMP",(@119) /\*Configure the function to temperature for channel 119\*/
73. TEMP:TRAN:TYPE TC,(@119) /\*Set the temperature sensor type to TC for channel 119\*/
74. TEMP:TRAN:TC:TYPE K,(@119) /\*Set the TC type to K for channel 119\*/
75. CALC:LIM:LOW 10,(@119) /\*Set the alarm lower limit to 10°C for channel 119\*/
76. CALC:LIM:LOW:STAT ON,(@119) /\*Enable the lower limit alarm for channel 119\*/
77. OUTP:ALAR3:SOUR (@119) /\*Set the alarm channel to Alarm3 for channel 119\*/
78. TEMP:TRAN:TC:CHEC ON,(@119) /\*Enable the T/C Check feature for channel 119\*/
79. TEMP:TRAN:TC:RJUN:TYPE INT,(@119) /\*Set the reference source to internal for channel 119\*/
80. FUNC "TEMP",(@120) /\*Configure the function to temperature for channel 120\*/
81. TEMP:TRAN:TYPE TC,(@120) /\*Set the temperature sensor type to TC for channel 120\*/
82. TEMP:TRAN:TC:TYPE S,(@120) /\*Set the TC type to S for channel 120\*/
83. TEMP:TRAN:TC:CHEC ON,(@120) /\*Enable the T/C Check feature for channel 120\*/
84. TEMP:TRAN:TC:RJUN:TYPE FIX,(@120) /\*Set the reference source to fixed for channel 120\*/
85. TEMP:TRAN:TC:RJUN 25.2,(@120) /\*Set the fixed reference junction temperature to 25.2°C for channel 120\*/
86. FUNC "CURR:DC",(@121,122) /\*Configure the function to DCI for channels 121 and 122\*/
87. CURR:DC:RANG:AUTO ON,(@121,122) /\*Enable autoranging for channels 121 and 122\*/
88. CALC:LIM:UPP 0.6,(@121,122) /\*Set the alarm upper limit to 0.6A for alarms for channels 121 and 122\*/
89. CALC:LIM:UPP:STAT ON,(@121,122) /\*Enable the upper limit alarm for channel 121 and 122\*/

```

90. OUTP:ALAR4:SOUR (@121,122) /*Set the alarm channel to Alarm4 for channels 121 and 122*/
91. CURR:DC:APER 1e-3,(@121,122) /*Set the gate time to 1ms for channels 121 and 122*/

92. FUNC "CURR:AC",(@123) /*Configure the function to ACI for channel 123*/
93. CURR:AC:RANG 1,(@123) /*Select the 1A range for channel 123*/
94. CURR:AC:BAND 3,(@123) /*Select the 3Hz AC filter parameter for channel 123*/
95. ROUT:CHAN:DEL 0.001,(@123) /*Set the channel delay to 1ms for channel 123*/

96. FUNC "SENSOR",(@124) /*Configure the function to Anysensor for channel 124*/
97. ANYS:TYPE CURR,(@124) /*Set the anysensor type to DCI for channel 124*/

98. FUNC "SENSOR",(@201) /*Configure the function to Anysensor for channel 201*/
99. ANYS:TYPE VOLT,(@201) /*Set the anysensor type to DCV for channel 201*/
100. ANYS:SEGM 0.03,1.001,1.1,0.01,(@201) /*Set Scaling parameter A to 1.001, B to 1.1
C to 0.01, startvalue to 0.03 for channel 201*/
101. ANYS:VOLT:APER 3e-3,(@201) /*Set the integration time to 0.3ms for channel 201*/
102. UNIT:ANY "mV",(@201) /*Set the unit to mV for channel 201*/

103. FUNC "SENSOR",(@202) /*Configure the function to Anysensor for channel 202*/
104. ANYS:TYPE RES,(@202) /*Set the anysensor type to 2WR for channel 202*/
105. ZERO:AUTO ON,(@202) /*Enable the auto zero function for channel 202*/

106. FUNC "SENSOR",(@203) /*Configure the function to Anysensor for channel 203*/
107. ANYS:TYPE FRES,(@203) /*Select the anysensor type to 4WR for channel 203*/
108. CALC:LIM:LOW 1000,(@203) /*Set the alarm lower limit to 1000Ω for alarms for channel 203*/
109. CALC:LIM:LOW:STAT ON,(@203) /*Enable the lower limit alarm for channel 203*/
110. OUTP:ALAR1:SOUR (@203) /*Set the alarm channel to Alarm4 for channel 203*/
111. ANYS:FRES:OCOM ON,(@203) /*Enable the offset compensation function for channel 203*/

112. FUNC "SENSOR",(@204) /*Configure the function to Anysensor for channel 204*/
113. ANYS:TYPE FREQ,(@204) /*Set the anysensor type to frequency for channel 204*/

114. DIG:DATA:BYTE? (@301) /*Configure the function to 8-bit DIN for channel 301*/
115. CALC:COMP:DATA 154,(@301) /*Set the alarm value to 154 for channel 301*/
116. CALC:COMP:MASK 129,(@301) /*Set the alarm mask to 129 for channel 301*/
117. CALC:COMP:TYPE EQU,(@301) /*Set the alarm mode to "equal" for channel 301*/
118. CALC:COMP:STAT ON,(@301) /*Enable the alarm function for channel 301*/
119. OUTP:ALAR2:SOUR (@301) /*Set the alarm channel to Alarm2 for channel 301*/
120. DIG:TYPE TTL,(@301) /*Set the level type to TTL for channel 301*/
121. DIG:DATA:WORD? (@303) /*Configure the function to 16-bit DIN for channel 303*/
122. CALC:COMP:DATA 121,(@303) /* Set the alarm value to 121 for channel 303*/
123. CALC:COMP:MASK 5,(@303) /* Set the alarm mask to 5 for channel 303*/
124. CALC:COMP:TYPE NEQ,(@303) /* Set the alarm mode to "not equal" for channel 303*/
125. CALC:COMP:STAT ON,(@303) /*Enable the alarm function for channel 303*/
126. OUTP:ALAR3:SOUR (@303) /*Set the alarm channel to Alarm3 for channel 303*/
127. DIG:TYPE USER,(@303) /*Set the level type to USER for channel 303*/
128. DIG:LEVel 5,(@303) /*Set the voltage level to 5V for channel 303*/
129. DIG:THReshold 3.5,(@303) /*Set the voltage threshold to 3.5V for channel 303*/

130. TOT:TYPE READ,(@305) /*Set the count mode to READ for channel 305*/
131. CALC:LIM:UPP 1000,(@305) /*Set the alarm upper limit to 1000 for channel 305*/
132. CALC:LIM:UPP:STAT ON,(@305) /*Enable the upper limit alarm for channel 305*/
133. OUTP:ALAR4:SOUR (@305) /*Set the alarm channel to Alarm4 for channel 305*/
134. TOT:SLOP NEG,(@305) /*Configure the trigger mode to falling edge trigger for channel 305*/

135. TOT:TYPE RRES,(@307) /*Set the count mode to RRESet for channel 307*/
136. TOT:SLOP POS,(@307) /*Configure the trigger mode to rising edge trigger for channel 307*/
137. TOT:THR 5,(@307) /*Set the threshold to 5V for channel 307*/

```

138. ROUT:SCAN (@101:115,119:124,201:206,301,303,305,307) /\*Add the above channels to the scan list\*/

## Method 2

1. \*IDN? /\*Query the ID string of M300 to check whether the remote communication is normal\*/
2. CONF:TEMP RTD,85,1,DEF,(@101) /\*Configure the function to temperature and set the sensor to RTD,85 for channel 101\*/
3. TEMP:NPLC 10 /\*Set the integration time to 10PLC for channel 101\*/
4. TEMP:TRAN:RTD:RES:REF 50 /\*Set R0 to 50Ω for channel 101\*/
5. CONF:VOLT AUTO,MIN,(@102) /\*Configure the function to DCV using the autoranging for channel 102 and reset the scan list \*/
6. CALC:SCAL:SQU 1.001 /\*Set scaling parameter A to 1.001 for channel 102\*/
7. CALC:SCAL:GAIN 1.1 /\*Set scaling parameter B to 1.1 for channel 102\*/
8. CALC:SCAL:OFFS 0.01 /\*Set scaling parameter C to 0.01 for channel 102\*/
9. CALC:SCAL:CONS 0.05 /\*Set scaling parameter x1 to 0.05 for channel 102\*/
10. CALC:SCAL:STAT ON /\*Enable the scaling function for channel 102\*/
11. CALC:LIM:UPP 10 /\*Set the alarm upper limit to 10V for channel 102\*/
12. CALC:LIM:UPP:STAT ON, /\*Enable the upper limit alarm for channel 102 \*/
13. CALC:LIM:LOW 0.7 /\*Set the alarm lower limit to 0.7V for channel 102\*/
14. CALC:LIM:LOW:STAT ON /\*Enable the lower limit alarm for channel 102\*/
15. OUTP:ALAR1:SOUR (@102) /\*Set the alarm channel to Alarm1 for channel 102\*/
16. VOLT:DC:NPLC 100 /\*Set the integration time to 100PLC for channel 102\*/
17. INP:IMP:AUTO ON /\*Enable the input impedance mode for channel 102\*/
18. CONF:VOLT:AC 20,DEF,(@103,104) /\*Configure the function to ACV using the 20V range for channels 103 and 104 and reset the scan list\*/
19. CALC:LIM:UPP 5 /\*Set the alarm upper limit to 5V for channels 103 and 104\*/
20. CALC:LIM:UPP:STAT ON /\*Enable the upper limit alarm for channels 103 and 104\*/
21. OUTP:ALAR2:SOUR (@103,104) /\*Set the alarm channel to Alarm2 for channels 103 and 104\*/
22. VOLT:AC:BAND 3 /\*Select the 3Hz AC filter for channels 103 and 104\*/
23. CONF:RES 10000000,DEF,(@105) /\*Configure the function to 2WR using the 100MΩ range for channel 105 and reset the scan list \*/
24. CALC:SCAL:UNIT "k" /\*Set the unit of the scaling parameters to k for channel 105\*/
25. CALC:SCAL:SQU 1.001 /\*Set scaling parameter A to 1.001 for channel 105\*/
26. CALC:SCAL:GAIN 1.1 /\*Set scaling parameter B to 1.1 for channel 105\*/
27. CALC:SCAL:OFFS 0.01 /\*Set scaling parameter C to 0.01 for channel 105\*/
28. CALC:SCAL:CONS 0.1 /\*Set scaling parameter x1 to 0.1 for channel 105 \*/
29. CALC:SCAL:STAT ON /\*Enable the scaling function for channel 105\*/
30. CALC:LIM:UPP 9e7 /\*Set the alarm upper limit to 90MΩ for channel 105\*/
31. CALC:LIM:UPP:STAT ON /\*Enable the upper limit alarm for channel 105\*/
32. OUTP:ALAR3:SOUR (@105) /\*Set the alarm channel to Alarm3 to report for channel 105\*/
33. RES:OCOM ON /\* Enable the offset compensation function for channel 105\*/
34. TEMP:NPLC 200 /\*Set the integration time to 200PLC for channel 106\*/
35. FRES:NPLC 0.2 /\*Set the integration time to 0.2PLC for channels 107 and 108\*/
36. ZERO:AUTO ON /\*Enable the auto zero function for channels 107 and 108\*/
37. CONF:FREQ DEF,0.01,(@109:110) /\*Configure the function to frequency for channels 109 and 110 and reset the scan list \*/
38. FREQ:VOLT:RANG:AUTO ON /\*Enable the autoranging for channels 109 and 110\*/
39. CALC:LIM:UPP 3000 /\*Set the alarm upper limit to 3kHz for channels 109 and 110\*/
40. CALC:LIM:UPP:STAT ON /\*Enable the upper limit alarm for channels 109 and 110\*/
41. OUTP:ALAR4:SOUR (@109:110) /\*Set the alarm channel to Alarm4 for channels 109 and 110\*/
42. FREQ:APER 1E-01 /\*Set the gate time to 0.1s for channels 109 and 110\*/



43. CONF:PER (@111,112) /\*Configure the function to period for channels 111 and 112 and reset the scan list \*/
44. PER:VOLT:RANG 300 /\*Select the 300V range for channels 111 and 112\*/
45. PER:RANG:LOW 200 /\*Select 200Hz Ac filter for channels 111 and 112\*/
46. CONF:TEMP TC,J,1,DEF,(@113) /\*Configure the function to temperature and set the sensor to TC, J for channel 113\*/
47. UNIT:TEMP F,(@113) /\*Set the unit to °F for channel 113\*/
48. CALC:SCAL:SQU 1.001 /\*Set scaling parameter A to 1.001 for channel 113\*/
49. CALC:SCAL:GAIN 1.1 /\*Set scaling parameter B to 1.1 for channel 113\*/
50. CALC:SCAL:OFFS 0.01 /\*Set scaling parameter C to 0.01 for channel 113\*/
51. CALC:SCAL:CONS 0.1 /\*Set scaling parameter x1 to 0.01 for channel 113\*/
52. CALC:SCAL:STAT ON /\*Enable the scaling function for channel 113\*/
53. CALC:LIM:UPP 30 /\*Set the alarm upper limit to 30°F for channel 113\*/
54. CALC:LIM:UPP:STAT ON /\*Enable the upper limit alarm for channel 113\*/
55. OUTP:ALAR1:SOUR (@113) /\*Set the alarm channel to Alarm1for channel 113\*/
56. TEMP:APER 0.0005 /\*Set the integration time to 0.5ms for channel 113\*/
57. TEMP:TRAN:TC:CHEC ON /\*Enable the T/C Check feature for channel 113\*/
58. ROUT:SCAN (@101) /\*Add channel 101 to the scan list\*/
59. TEMP:TRAN:TC:RJUN:TYPE EXT /\*Set the reference source to external for channel 113 \*/
60. ZERO:AUTO ON /\*Enable the auto zero function for channel 113\*/
61. CONF:TEMP THER,5000,1,DEF,(@114) /\*Configure the function to temperature and set the sensor to THER,5000 for channel 114\*/
62. CALC:LIM:LOW 10 /\*Set the alarm lower limit to 10°C for channel 114\*/
63. CALC:LIM:LOW:STAT ON /\*Enable the lower limit alarm for channel 114\*/
64. OUTP:ALAR2:SOUR (@114) /\*Set the alarm channel to Alarm2 for channel 114\*/
65. TEMP:NPLC 2 /\*Set the integration time to 2PLC for channel 114\*/
66. ZERO:AUTO ON /\*Enable the auto zero function for channel 114\*/
67. CONF:TEMP RTD,91,1,DEF,(@115) /\*Configure the function to temperature and set the sensor to RTD,91 for channel 115\*/
68. TEMP:NPLC 20 /\*Set the integration time to 20PLC for channel 115\*/
69. CONF:TEMP TC,K,1,DEF,(@119) /\*Configure the function to temperature and set the sensor to TC,K for channel 119\*/
70. CALC:LIM:LOW 10 /\*Set the alarm lower limit to 10°C for channel 119 \*/
71. CALC:LIM:LOW:STAT ON /\*Enable the lower limit alarm for channel 119\*/
72. OUTP:ALAR3:SOUR (@119) /\*Set the alarm channel to Alarm3 for channel 119\*/
73. TEMP:TRAN:TC:CHEC ON /\*Enable the T/C Check feature for channel 119\*/
74. TEMP:TRAN:TC:RJUN:TYPE INT /\*Set the reference source to internal for channel 119\*/
75. CONF:TEMP TC,S,1,DEF,(@120) /\*Configure the function to temperature and set the sensor to TC, S for channel 120\*/
76. TEMP:TRAN:TC:CHEC ON /\*Enable the T/C Check feature for channel 120\*/
77. TEMP:TRAN:TC:RJUN:TYPE FIX /\*Set the reference source to fixed for channel 120\*/
78. TEMP:TRAN:TC:RJUN 25.2 /\*Set the fixed reference junction temperature to 25.2°C for channel 120\*/
79. CONF:CURR:DC AUTO,DEF,(@121,122) /\*Configure the function to DCI using the autoranging for channels 121 and 122and reset the scan list \*/
80. CALC:LIM:UPP 0.6 /\*Set the alarm upper limit to 0.6A for channels 121 and 122\*/
81. CALC:LIM:UPP:STAT ON /\*Enable the upper limit alarm for channel 121 and 122\*/
82. OUTP:ALAR4:SOUR (@121,122) /\*Set the alarm channel to Alarm4 for channels 121 and 122\*/
83. CURR:DC:APER 1e-3 /\*Set the integration time to 1ms for channels 121 and 122\*/
84. CONF:CURR:AC 1,DEF,(@123) /\*Configure the function to anysensor ACI with 1A range for channel 123and reset the scan list \*/
85. CURR:AC:BAND 3 /\*Select the 3Hz AC filter for channel 123\*/

86. ROUT:CHAN:DEL 0.001 /\*Set the channel delay to 1ms for channel 123\*/
87. CONF:ANYS (@124) /\*Configure the function to anysensor DCI for channel 124 and reset the scan list \*/
88. CONF:ANYS (@201) /\*Configure the function to anysensor ACV for channel 201 and reset the scan list \*/
89. ANYS:SEGM 0.03,1.001,1.1,0.01 /\*Set scaling parameter A to 1.001, B=1.1, C=0.01, startvalue=0.03 for channel 201 \*/
90. ANYS:VOLT:APER 3e-3 /\*Set the integration time to 3ms for channel 201\*/
91. UNIT:ANY "mV",(@201) /\*Set the unit to mV for channel 201\*/
92. CONF:ANYS RES,(@202) /\*Configure the function to anysensor 2WR for channel 202 and reset the scan list\*/
93. ZERO:AUTO ON /\*Enable the auto zero function for channel 202\*/
94. CONF:ANYS FRES,(@203) /\*Configure the function to anysensor 4WR for channel 203 and reset the scan list \*/
95. CALC:LIM:LOW 1000 /\*Set the alarm lower limit to 1000Ω for channel 203\*/
96. CALC:LIM:LOW:STAT ON /\*Enable the lower limit alarm for channel 203\*/
97. OUTP:ALAR1:SOUR (@203) /\*Set the alarm channel to Alarm1 for channel 203\*/
98. CONF:ANYS FREQ,(@204) /\*Configure the function to anysensor frequency for channel 204 and reset the scan list \*/
99. CONF:DIG:BYTE (@301) /\*Configure channel 301 to 8-bit digital input and reset the scan list \*/
100. CALC:COMP:DATA 154 /\*Set the alarm value to 154 for channel 301\*/
101. CALC:COMP:MASK 129 /\*Set the alarm mask to 129 for channel 301\*/
102. CALC:COMP:TYPE EQU /\*Set the alarm mode to "equal" for channel 301\*/
103. CALC:COMP:STAT ON /\*Enable the alarm function for channel 301\*/
104. OUTP:ALAR2:SOUR (@301) /\*Set the alarm channel to Alarm2 for channel 301\*/
105. DIG:TYPE TTL,(@301) /\*Set the level type to TTL for channel 301\*/
106. CONF:DIG:WORD (@303) /\*Configure channel 303 to 16-bit digital input and reset the scan list \*/
107. CALC:COMP:DATA 121 /\*Set the alarm value to 121 for channel 303\*/
108. CALC:COMP:MASK 5 /\*Set the alarm mask to 5 for channel 303\*/
109. CALC:COMP:TYPE NEQ /\*Set the alarm mode to "not equal" for channel 303\*/
110. CALC:COMP:STAT ON /\*Enable the alarm function for channel 303\*/
111. OUTP:ALAR3:SOUR (@303) /\*Set the alarm channel to Alarm3 for channel 303\*/
112. DIG:TYPE USER,(@303) /\*Set the level type to USER for channel 303\*/
113. DIG:LEVel 5,(@303) /\*Set the voltage level to 5V for channel 303\*/
114. DIG:THReshold 3.5,(@303) /\*Set the voltage threshold to 3.5V for channel 303\*/
115. CONF:TOT READ,(@305) /\*Configure channel 305 to TOT READ mode and reset the scan list\*/
116. CALC:LIM:UPP 1000 /\*Set the alarm upper limit to 1000 for channel 305\*/
117. CALC:LIM:UPP:STAT ON /\*Enable the upper limit alarm for channel 305 \*/
118. OUTP:ALAR4:SOUR (@305) /\*Set the alarm channel to Alarm4 for channel 305\*/
119. TOT:SLOP NEG /\*Set the trigger mode to falling edge trigger for channel 305\*/
120. CONF:TOT RRES,(@307) /\*Configure channel 307 to TOT RRESet mode and reset the scan list\*/
121. TOT:SLOP POS /\*Set the trigger mode to rising edge trigger for channel 307\*/
122. TOT:THR 5 /\*Set the threshold to 5V for channel 307\*/
123. ROUT:SCAN (@101:115,119:124,201:206,301,303,305,307) /\*Add the above channels to the scan list\*/

## To Configure the Scan List

### Requirements

Use the SCPI commands to realize the following functions:  
Configure the scan list as follows, and initiate the scan.

Scan count	Trigger mode	Related setting
10	TIMer	Interval: 0.05s
1	BUS	None
1	EXTernal	Edge: Falling
1	ABSolute	Time: 8:00 every day
1	ALARm2	Channel: Alarm2

1. \*IDN? /\*Query the ID string of M300 to check whether the remote communication is normal\*/
2. TRIG:COUN 10 /\*Set the number of scans to 100\*/
3. TRIG:SOUR TIM /\*Set the trigger mode to auto (timer)\*/
4. TRIG:TIM 0.05 /\*Set the scan interval to 0.05s\*/
5. READ? /\*Initiate the scan and read the readings\*/
6. CALC:AVER:MAX? (@102:106) /\*Query the maximum values for channels 102 through 106\*/
7. CALC:AVER:MIN? (@102:106) /\*Query the minimum values for channels 102 through 106\*/
8. CALC:AVER:AVE? (@102:106) /\*Query the average values for channels 102 through 106\*/
9. CALC:AVER:PTP? (@102:106) /\*Query the peak to peak values for channels 102 through 106\*/
10. CALC:AVER:SDEV? (@102:106) /\*Query the standard deviation values for channels 102 through 106\*/
  
11. TRIG:COUN 1 /\*Set the number of scans to 1\*/
12. TRIG:SOUR BUS /\*Set the trigger source to manual\*/
13. INIT /\*Place the instrument in the "wait-for-trigger" state\*/
14. \*TRG /\*Trigger a scan\*/
15. R? /\*Read and erase the readings\*/
  
16. TRIG:COUN 1 /\*Set the number of scans to 1\*/
17. TRIG:SOUR EXT /\*Set the trigger mode to external\*/
18. TRIG:EDGE FALL /\*Set the edge type of the trigger signal to falling\*/
19. INIT /\*Place the instrument in the "wait-for-trigger" state\*/
20. FETCh? /\*Read the readings\*/
  
21. TRIG:COUN 5 /\*Set the number of scans to 5\*/
22. TRIG:SOUR ABS /\*Set the trigger mode to absolute time\*/
23. TRIG:ABS \*,\*,8,0,0 /\*Set the trigger absolute time to 8:00 every day\*/
24. INIT /\*Place the instrument in the "wait-for-trigger" state\*/
25. FETCh? /\*Read the readings\*/
  
26. TRIG:COUN 1 /\*Set the number of scans to 1\*/
27. TRIG:SOUR AIAR2 /\*Set the trigger mode to alarm\*/
28. ROUT:MON:CHAN (@103,104) /\*Add channels 103 and 104 into the monitor list\*/
29. ROUT:MON:STAT ON /\*Enable the monitor mode\*/
30. INIT /\*Place the instrument in the "wait-for-trigger" state\*/
31. FETCh? /\*Read the readings\*/

## Monitor

### Conditions

MC3324 module in Slot1

MC3132 module in Slot2  
 MC3534 module in Slot3  
 MC3065 module in Slot4  
 MC3648 module in Slot5

### Requirements

Use the SCPI commands to realize the following functions:  
 Configure the channels as follows and monitor these channels.

Channel	Configuration	
	Measurement Function	Parameter
101:103	VOLT:AC;	Range: 200V; AC filter: 3Hz;
121:122	CURR:DC;	Range: Auto; Integration time: 1PLC;
301	DOUT;	DATA: 121;
305	TOT; READ	SLOP: POS

1. \*IDN? /\*Query the ID string of M300 to check whether the remote communication is normal\*/
2. CONF:VOLT:AC 200,DEF,(@101:103) /\*Configure channels 101 through 103 to the ACV measurement function with 200V range and overwrite the current scan list\*/
3. VOLT:AC:BAND 3 /\*Set the AC filter to 3Hz for channels 101 through 103\*/
4. CONF:CURR:DC AUTO,DEF,(@121,122) /\*Configure channels 121 and 122 to the DCI measurement function with autorange and overwrite the current scan list\*/
5. ROUT:SCAN (@101:103,121,122) /\*Add channels 101, 102, 103, 121 and 122 into the scan list\*/
6. SOUR:DIG:DATA:DWOR 121,(@301) /\*Configure channel 301 to output an 32-bit double-word digital pattern, 121\*/
7. DIG:TYPE TTL,(@301) /\*Set the level type to TTL for channel 301\*/
8. TOT:TYPE READ,(@305) /\*Configure channel 305 to the read mode\*/
9. TOT:SLOP POS,(@105) /\*Configure channel 305 to start counting on the rising edge of the input signal\*/
10. ROUT:MON:CHAN (@101:103,121,122,301,305) /\*Add channels 101, 102, 103, 121, 122, 301 and 305 into the monitor list\*/
11. ROUT:MON:STAT ON /\*Enable the multi-channel monitor mode\*/
12. ROUT:MON:STAT OFF /\*Disable the monitor mode\*/

## Store and Recall

### Store and Recall in Internal Memory

#### Requirements

Use the SCPI commands to realize the following functions:

Configure the instrument as shown in the table below and save the current system configuration with the filename "sys20130708" to the internal memory. Then, recall the system configuration file and overwrite the current system configuration.

Configuration Item	Status
sound	ON
screen saver	ON
decimal point	.
separator	None
power key	OFF
brightness	10

1. \*IDN? /\*Query the ID string of M300 to check whether the remote communication is normal\*/
2. SYST:UTI:BEEP:STAT ON /\*Enable the beeper\*/
3. SYST:UTI:SAVE:STAT ON /\*Enable the screen saver function\*/
4. SYST:UTI:FORM:DECI DOT /\*Set the display form of the decimal point of the screen data to "."\*/
5. SYST:UTI:FORM:SEPA NONE /\*Set the display form of the separator of the screen data to "None"\*/
6. SYST:UTI:POWE:SWIT:STAT ON /\*Set the status of the power switch to "ON"\*/
7. SYST:UTI:DISP:BRIG 10 /\*Set the brightness of the screen to 10\*/
8. MEM:SAVE:SYST "sys20130708" /\*Save the current system configuration in the sys20130708.sfg file in the internal memory\*/
9. MEM:REC:SYST "sys20130708" /\*Recall the sys20130708.sfg file and overwrite the current system configuration\*/

### To Store System Configuration and Scan Data in the USB Storage Device

#### Requirements

Use the SCPI commands to realize the following functions:

Store the scan list configuration in the USB storage device; store the system configuration and scan data in the USB storage device; set the separator of the scan data to "," and enable the row limit of the data stored.

1. \*IDN? /\*Query the ID string of M300 to check whether the remote communication is normal\*/
2. MMEM:FORM:READ:CSEP COMM /\*Set the separator of the data in the USB storage device to comma\*/
3. MMEM:FORM:READ:RLIM ON /\*Enable the row limit\*/
4. MMEM:EXP? /\*Export the readings in the reading memory and the instrument configuration to the USB storage device\*/

## To Import the .blcfg File from the USB Storage Device

### Requirements

Use the SCPI commands to realize the following functions:

Import the Configure.blcfg file from the USB storage device.

1. \*IDN?                               /\*Query the ID string of M300 to check whether the remote communication is normal\*/
2. MMEM:IMP:CAT?   /\*Query the blcfg file in the root directory of the USB storage device\*/
3. MMEM:IMP:CONF? "Configure.blcfg"   /\*Import the "Configure.blcfg" file from the USB storage device \*/

## Copy

### Conditions

MC3132 module in Slot1  
 MC3132 module in Slot2  
 MC3164 module in Slot3  
 MC3164 module in Slot4  
 MC3065 module in Slot5

## Channel Copy

### Requirements

Use the SCPI commands to realize the following functions:

Channel copy: copy the source channel configuration to the destination channels. The source channel configuration and the destination channels are as follows.

Source Channel Configuration		Destination Channel
Channel	Parameter	
101	Function: VOLT:DC; Range: 20V; Integration time: 100PLC; Alarm upper limit: 15V; Alarm channel: Alarm1	105:109,201:203

1. \*IDN? /\*Query the ID string of M300 to check whether the remote communication is normal\*/
2. CONF:VOLT:DC 20,7e-7,(@101) /\*Configure channel 101 to the DCV measurement function with 20V range and 100PLC integration time; overwrite the current scan list\*/
3. CALC:LIM:UPP 15,(@101) /\*Set the alarm upper limit to 15V for channel 101\*/
4. CALC:LIM:UPP:STAT ON,(@101) /\*Enable the upper limit alarm for channel 101\*/
5. OUTP:ALAR1:SOUR (@101) /\*Set the alarm channel to Alarm1 for channel 101\*/
6. CONF:COPY:CH:CH (@101),(@105:109,201:203) /\*Copy the configuration of channel 101 to channels 105, 106, 107, 108, 109, 201, 202 and 203.\*/

## Extended Copy

### Requirements

Use the SCPI commands to realize the following functions:

Extended copy: copy the source channel configuration to all the channels of the destination module. The source channel configuration and the destination module are as follows.

Source Channel Configuration		Destination module
Channel	Parameter	
101	Function: VOLT:DC; Range: 20V; Integration time: 100PLC; Alarm upper limit: 15V; Alarm channel: Alarm1	MC3132 in Slot2

1. \*IDN? /\*Query the ID string of M300 to check whether the remote communication is normal\*/
2. CONF:VOLT:DC 20,7e-7,(@101) /\*Configure channel 101 to the DCV measurement function with 20V range and 100PLC integration time; overwrite the current scan list\*/
3. CALC:LIM:UPP 15,(@10) /\*Set the alarm upper limit to 15V for channel 101\*/
4. CALC:LIM:UPP:STAT ON,(@101) /\*Enable the upper limit alarm for channel 101\*/
5. OUTP:ALAR1:SOUR (@101) /\*Set the alarm channel to Alarm1 for channel 101\*/
6. CONF:COPY:CH:SLOT (@101),200 /\*Copy the configuration of channel 101 to all the channels of Slot2\*/

## Module Copy

### Requirements

Use the SCPI commands to realize the following functions:

Module copy: copy the source module configuration to the destination module. The source module configuration and the destination module are as follows.

Source Module Configuration		Destination module
Channel	Parameter	
301:331	Function: VOLT:DC; Range: 20V; Integration time: 100PLC;	MC3164 in Slot4
332:364	Function: RES; Range: Auto; Integration time: 10PLC;	

1. \*IDN? /\*Query the ID string of M300 to check whether the remote communication is normal\*/
2. CONF:VOLT:DC 20,7e-7,(@301:331) /\*Configure channels 301 through 331 to the DCV measurement function with 20V range and 100PLC integration time; overwrite the current scan list\*/
3. CONF:RES AUTO,DEF,(@332:364) /\*Configure channels 332 through 364 to the 2WR measurement function with autorange and overwrite the current scan list\*/
4. RES:NPLC 10 /\*Set the integration time to 10PLC for channels 332 to 364\*/
5. CONF:COPY:SLOT:SLOT3,400 /\*Copy the configuration of Slot3 to Slot4\*/



## To Output Digital Signal

### Conditions

MC3534 module in Slot3

### Requirements

Use the SCPI commands to realize the following functions:

Configure channels 301 and 302 as an 8-bit output terminal to output 121; set the level type to COMS5.

Configure channel 303 as a 16-bit output terminal to output 25; set the level type to USER, the level value to 4.5V and the level threshold to 2V.

1. \*IDN? /\*Query the ID string of M300 to check whether the remote communication is normal\*/
2. DIG:TYPE CMOS5,(@301,302) /\*Set the level type to CMOS5V for channels 301 and 302\*/
3. DIG:TYPE USER,(@303) /\*Set the level type to USER for channel 303\*/
4. DIG:LEV 4.5,(@303) /\*Set the voltage level value to 4.5V for channel 303\*/
5. DIG:THR 2,(@303) /\*Set the voltage threshold to 2V for channel 303\*/
6. SOUR:DIG:DATA:BYTE 121,(@301,302) /\*Configure channels 301 and 302 as an 8-bit output terminal to output 121\*/
7. SOUR:DIG:DATA:BYTE 25,(@303) /\*Configure channel 303 as a 16-bit output terminal to output 25\*/

## To Output Analog Voltage

### Conditions

MC3534 module in Slot3

### Requirements

Use the SCPI commands to realize the following functions:

Configure channels 309 and 310 to output +3.3 voltage.

Configure channels 311 and 312 to output -3.3 voltage.

1. \*IDN? /\*Query the ID string of M300 to check whether the remote communication is normal\*/
2. SOUR:VOLT 3.3,(@309:310) /\*Set the output voltage to 3.3V for channels 309 and 310\*/
3. SOUR:VOLT -3.3,(@311,312) /\*Set the output voltage to -3.3V for channels 311 and 312\*/



## Chapter 4 Programming Demos

This chapter provides the demos for programming and controlling the M300 series Data Acquisition/Switch System using SCPI commands under various environment (such as the Visual Basic and Visual Studio) on the basis of NI-VISA.

NI-VISA (National Instrument-Virtual Instrument Software Architecture) is an advanced application programming interface developed by NI (National Instrument) for communicating with various instrument buses. It can communicate with instrument in the same method regardless of the type of the instrument interface (GPIB, USB, LAN/Ethernet or RS232).

The instruments communicate with NI-VISA via various interfaces are called "resources". The VISA descriptor (namely the resource name) is used to describe the accurate name and location of the VISA resource. If LAN interface is currently used for communicating with the instrument, the VISA descriptor is TCPIP::172.16.3.4::INSTR. Before programming, please acquire the correct VISA descriptor.

### Main topics of this chapter:

- [Programming Preparations](#)
- [LabVIEW Programming Demo](#)
- [C++ Programming Demo](#)
- [C# Programming Demo](#)

## Programming Preparations

Before programming, you need to make the following preparations:

- 1 Make sure that your PC has installed the NI-VISA library (can be downloaded from NI website: <http://www.ni.com/visa/>). Here, the default installation path is C:\Program Files\IVI Foundation\VISA.
- 2 Here, the USB interface of the M300 series Data Acquisition/Switch System is used to communicate with the PC and please use a USB cable to connect the USB DEVICE interface at the rear panel of the M300 to the PC. You can also use the LAN, RS232 or GPIB interface to communicate with the PC. Note that the end mark of the command sent through the RS232 interface is "\r\n".
- 3 Turn on the instrument after connecting the instrument and PC.
- 4 At this point, the "**Found New Hardware Wizard**" dialog box appears on the PC. Please follow the instructions to install the "USB Test and Measurement Device (IVI)".

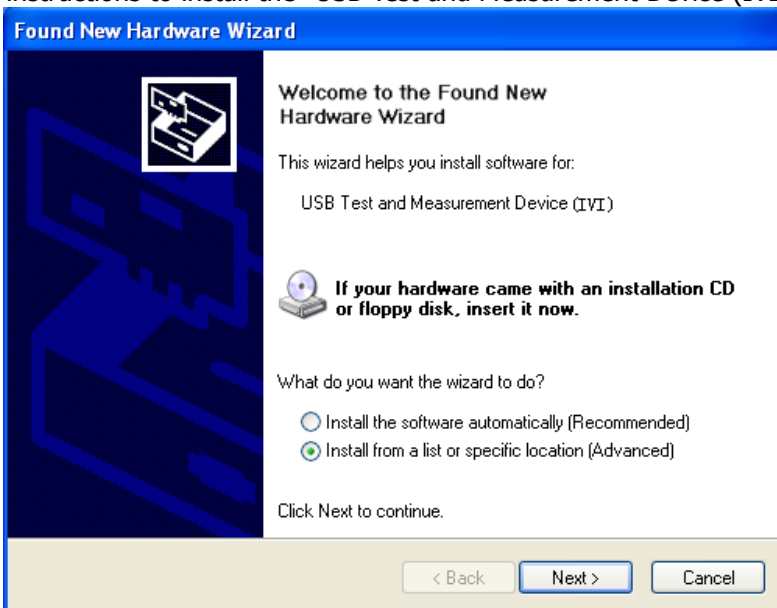

- 5 Acquire the USB VISA descriptor of the M300 series Data Acquisition/Switch System: press **Utility** → **I/O** → **USB** → **Device** and the VISA descriptor is displayed at the interface, as shown in the figure below. Here, the VISA descriptor of the M300 series Data Acquisition/Switch System is `usb0::6833::3200::M300123123123::0::INSTR`.



By now, the programming preparations are finished.

## LabVIEW Programming Demo

**The program used in this Demo:** LabVIEW 2009

**The functions realized in this Demo:** search for the instrument address, connect the instrument, send command and read the return value.

- 1 Run LabVIEW 2009, create a VI file and name it as M300\_Demo\_LABVIEW.
- 2 Add controls in the front panel interface, including the **Address** bar, **Slot** bar, **Command** bar, **Channel** bar and **Return** bar, the **Connect**, **Write**, **Read**, **Exit**, **DCV**, **DCI**, **ACV**, **ACI**, **2WR**, **4WR**, **Frequency**, **Period**, **Temperature**, **Anysensor**, **Init Scan**, **Abort Scan** and **System Error** buttons as well as **Temperature Type** and **Anysensor Type** combo boxes.

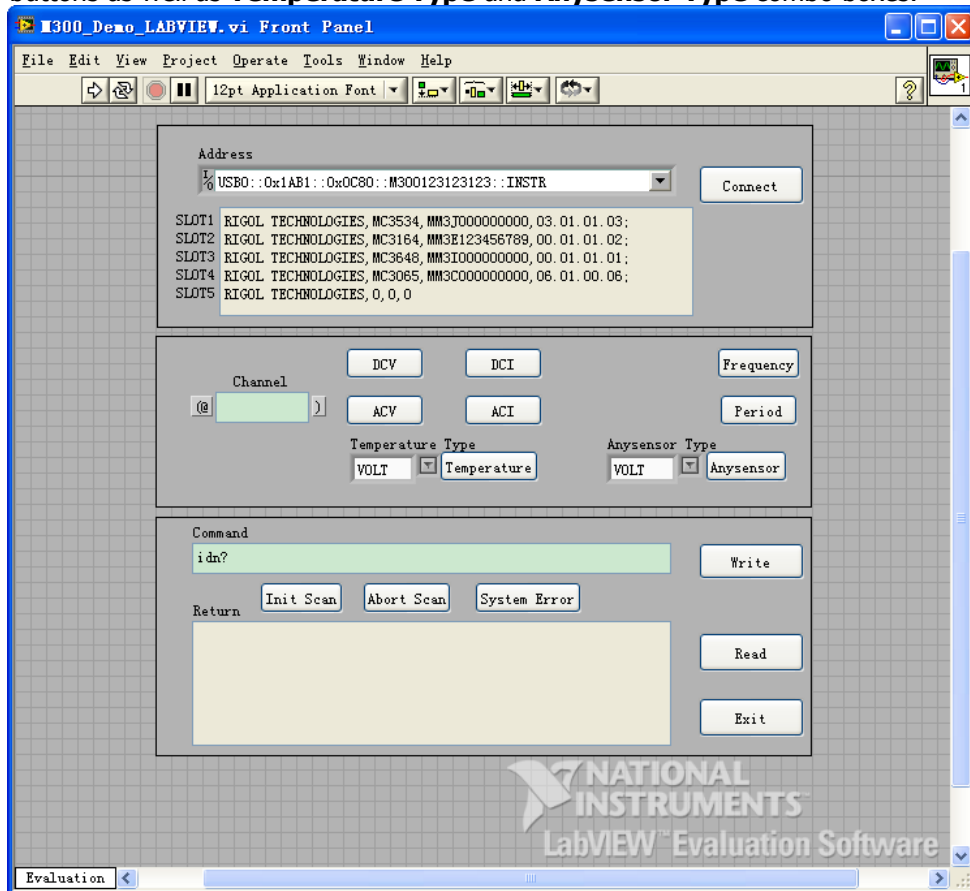

- 3 Click **Show Block Diagram** in the **Window** menu to create event structure.

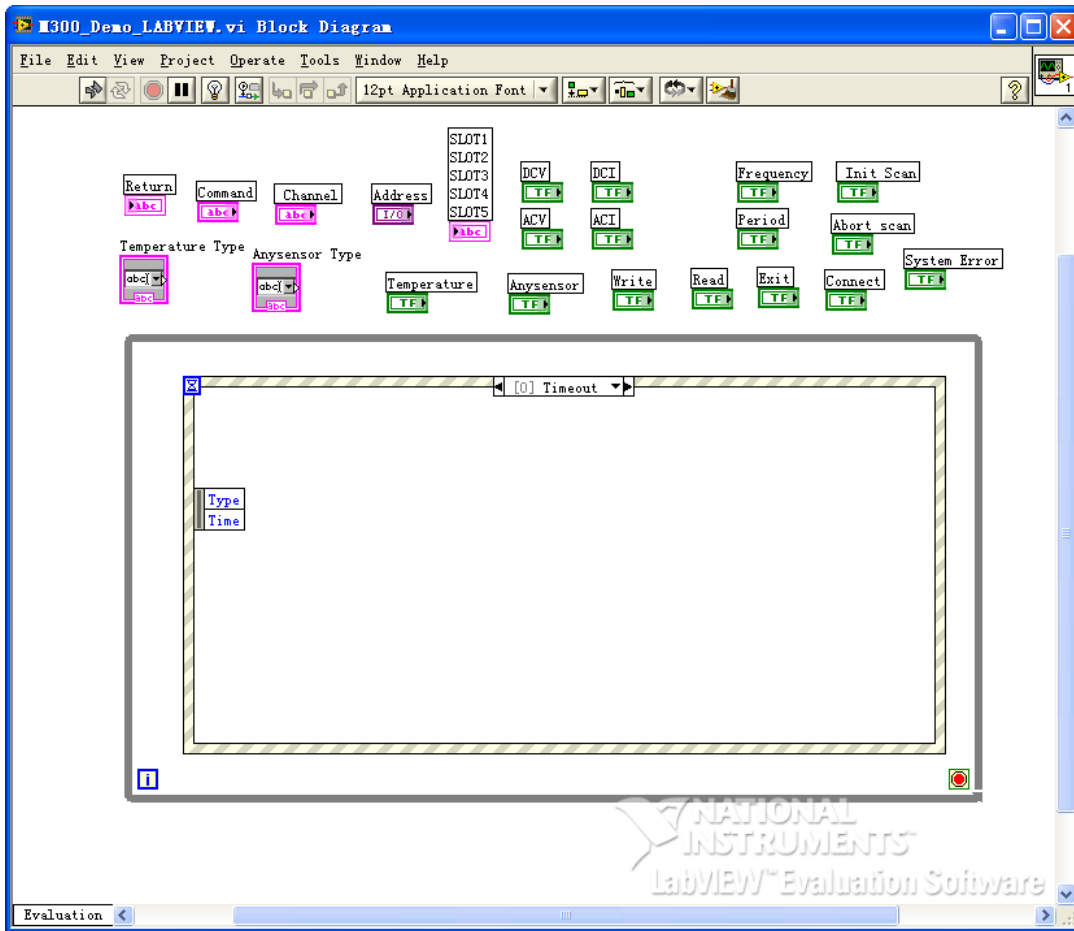

4 Add button events as follows.

- (1) Connect the instrument (including error processing) first, then query the module information for the five slots and display the module information in the **slot** bar.

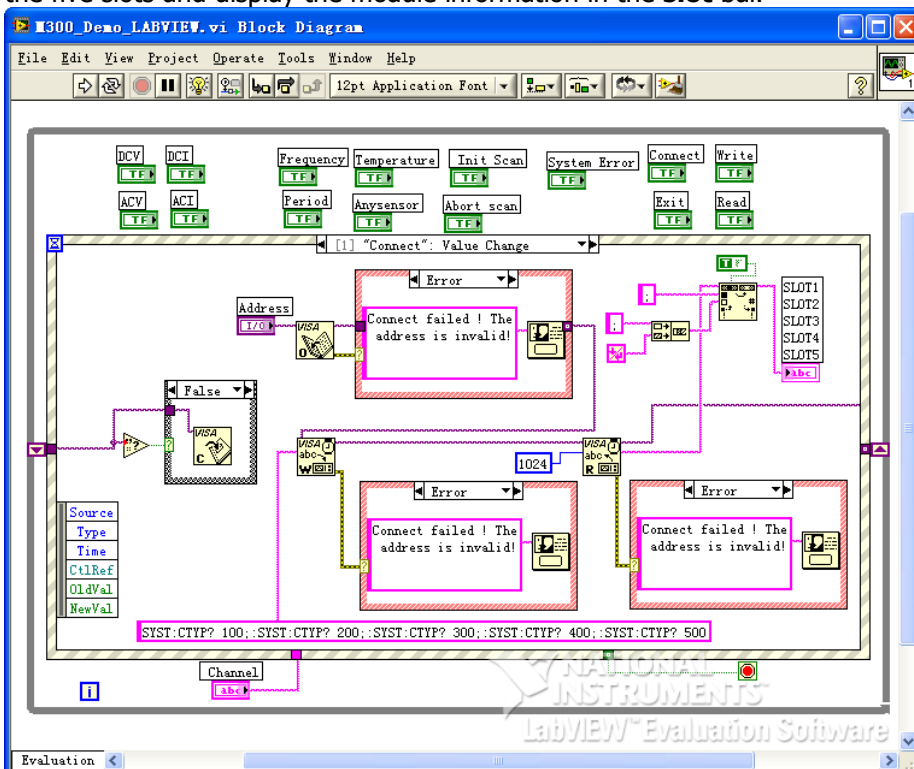

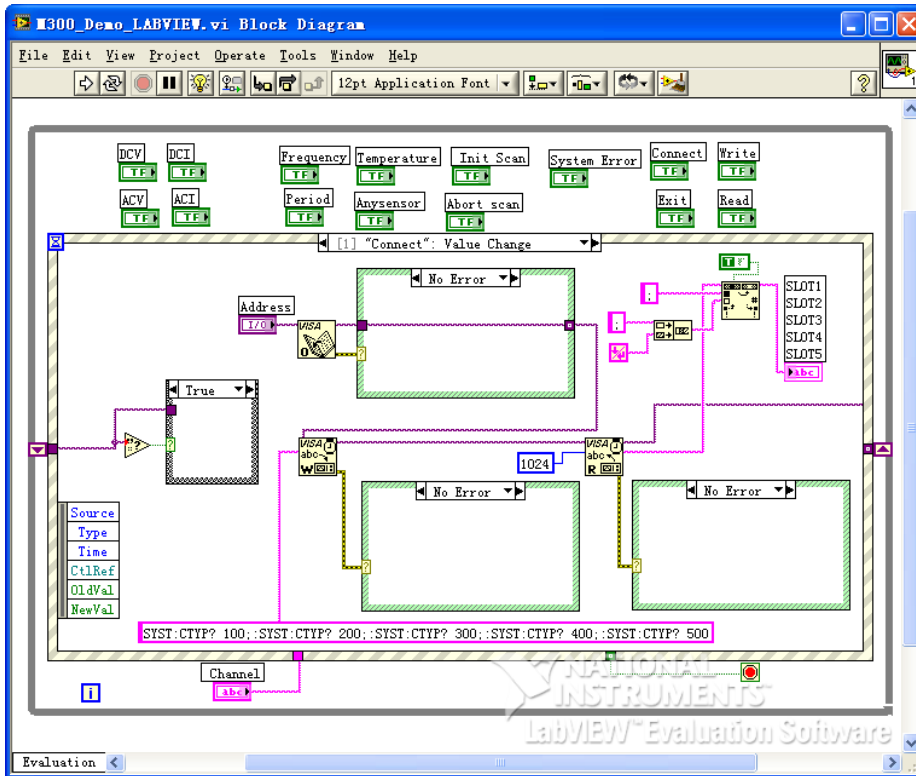

(2) The text value of Channel control has changed.

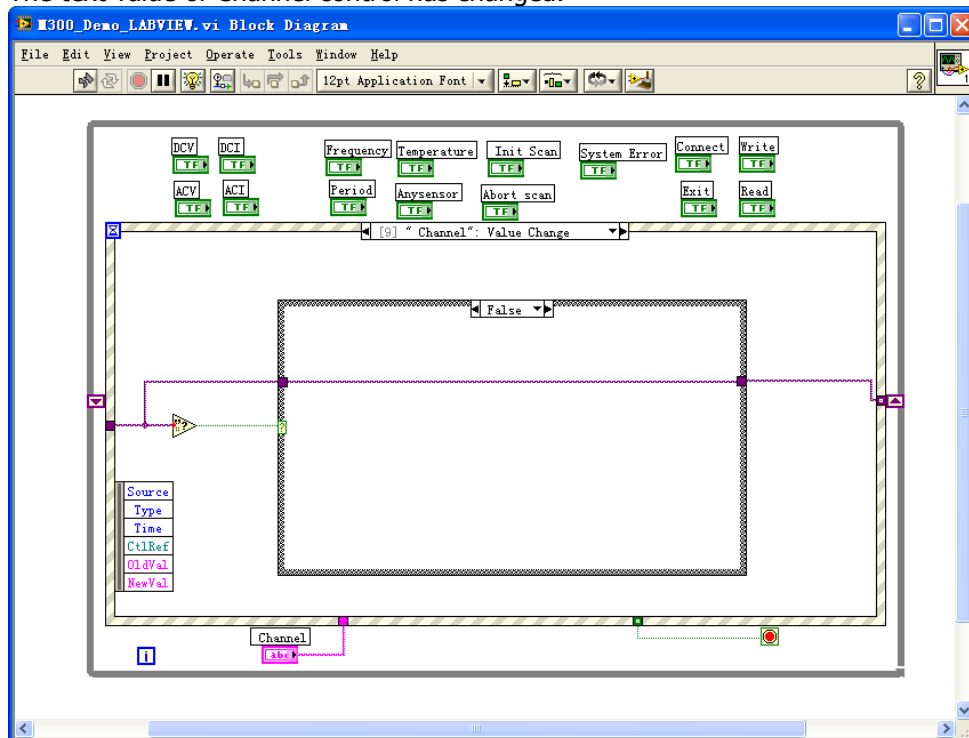

(3) Configure the specified channels to the DCV measurement function and overwrite the current scan list.

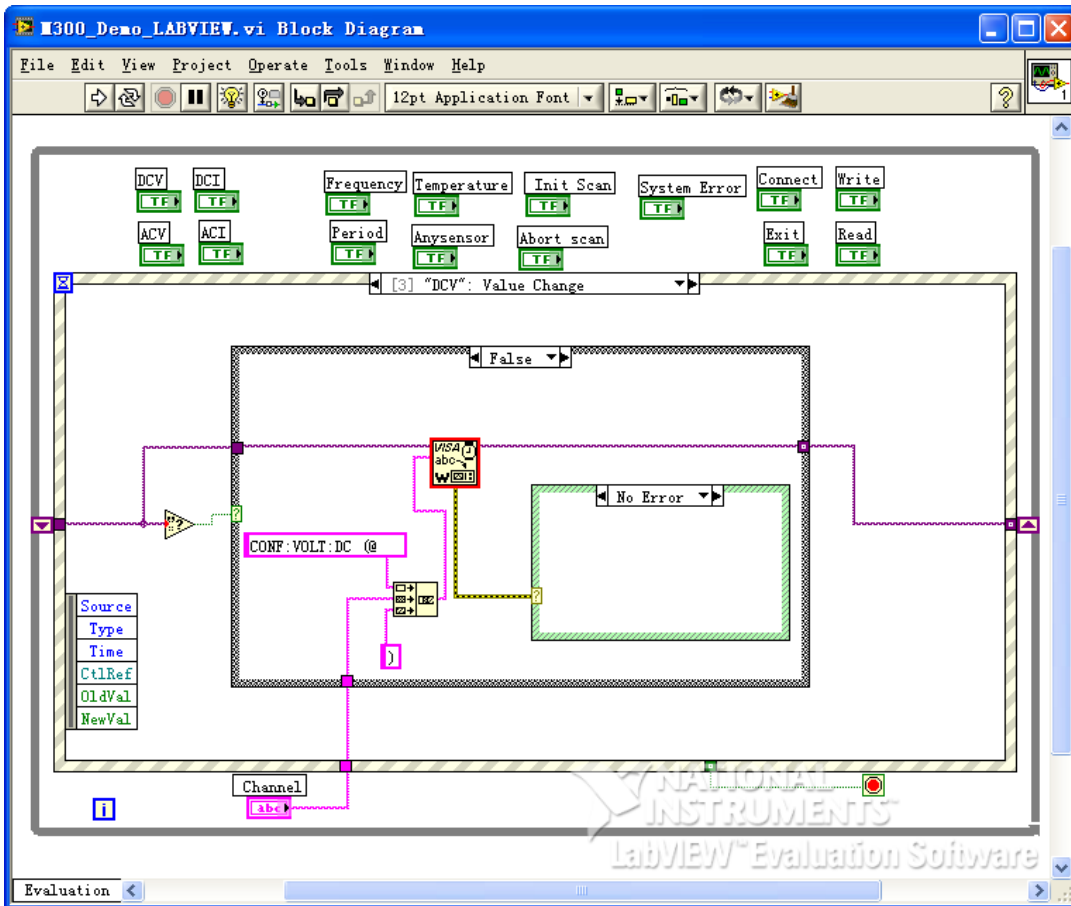

- (4) Configure the specified channels to the DCI measurement function and overwrite the current scan list.

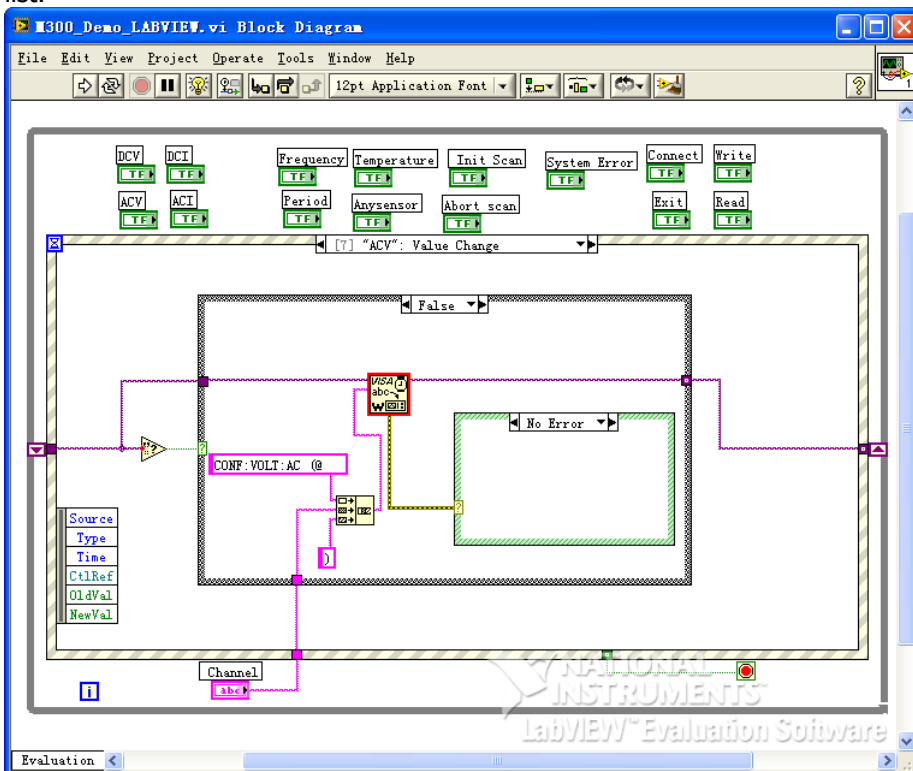

- (5) Configure the specified channels to the ACV measurement function and overwrite the current scan list.



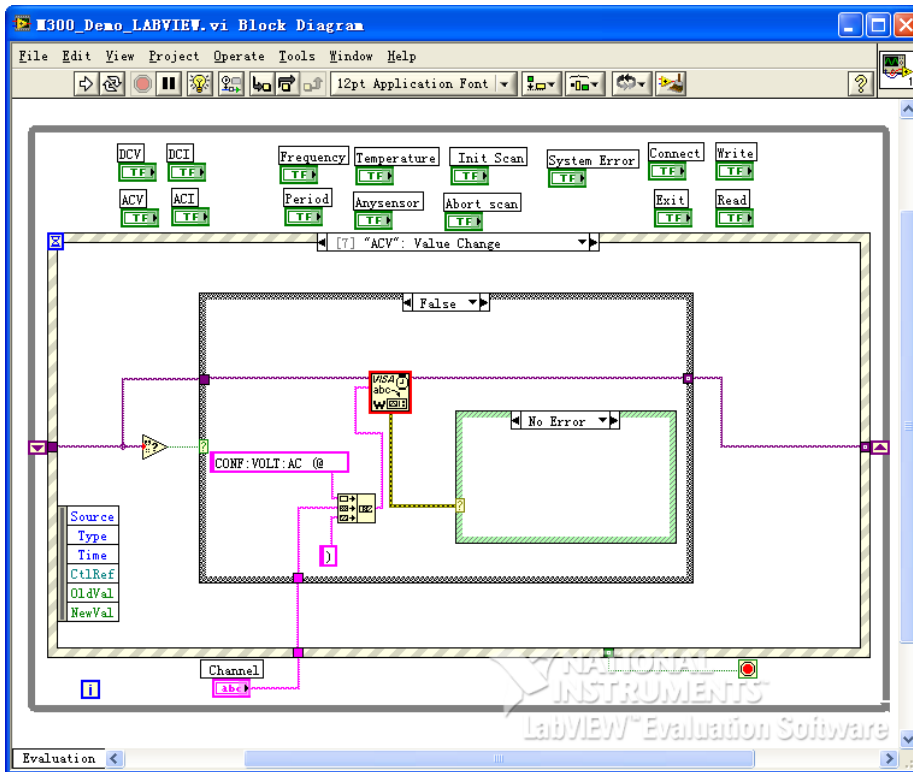

- (6) Configure the specified channels to the ACI measurement function and overwrite the current scan list.

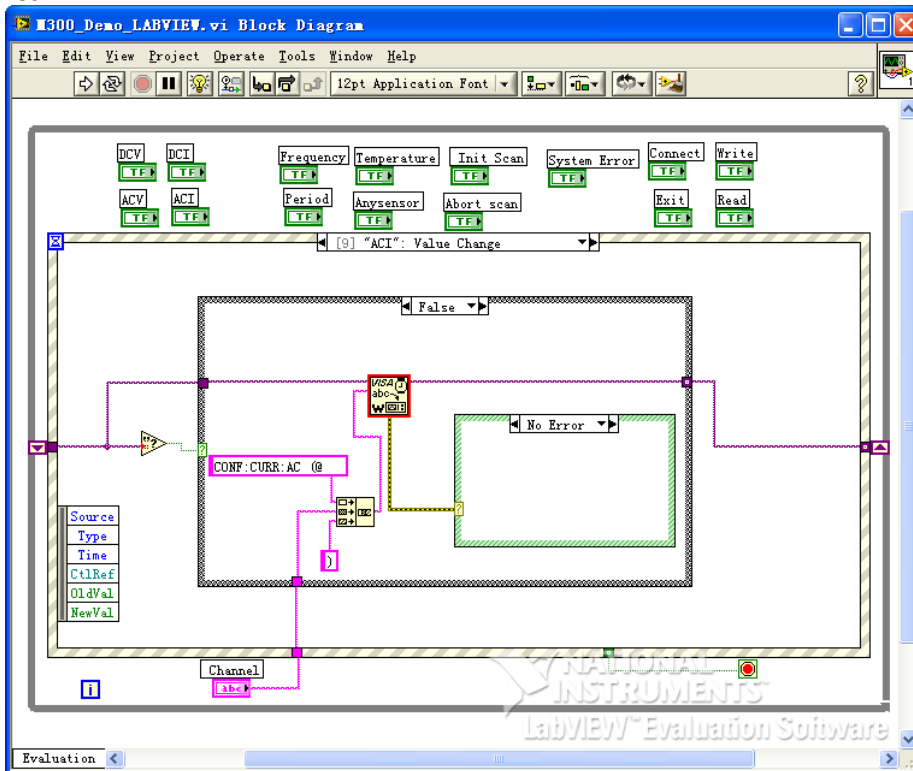

- (7) Configure the specified channels to the Frequency measurement function and overwrite the current scan list.

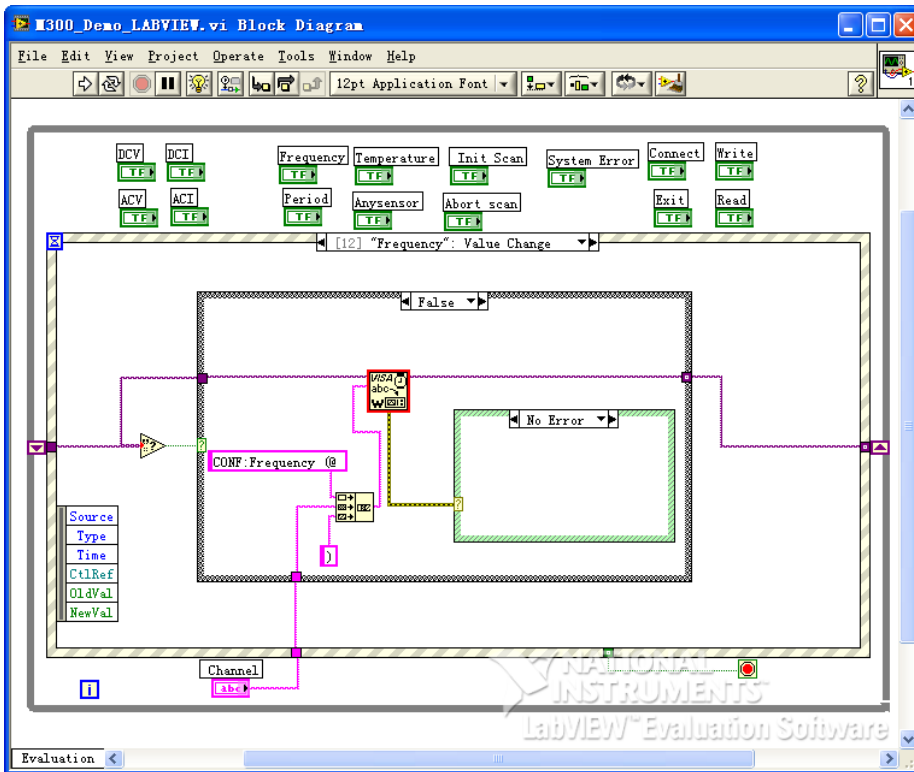

- (8) Configure the specified channels to the Period measurement function and overwrite the current scan list.

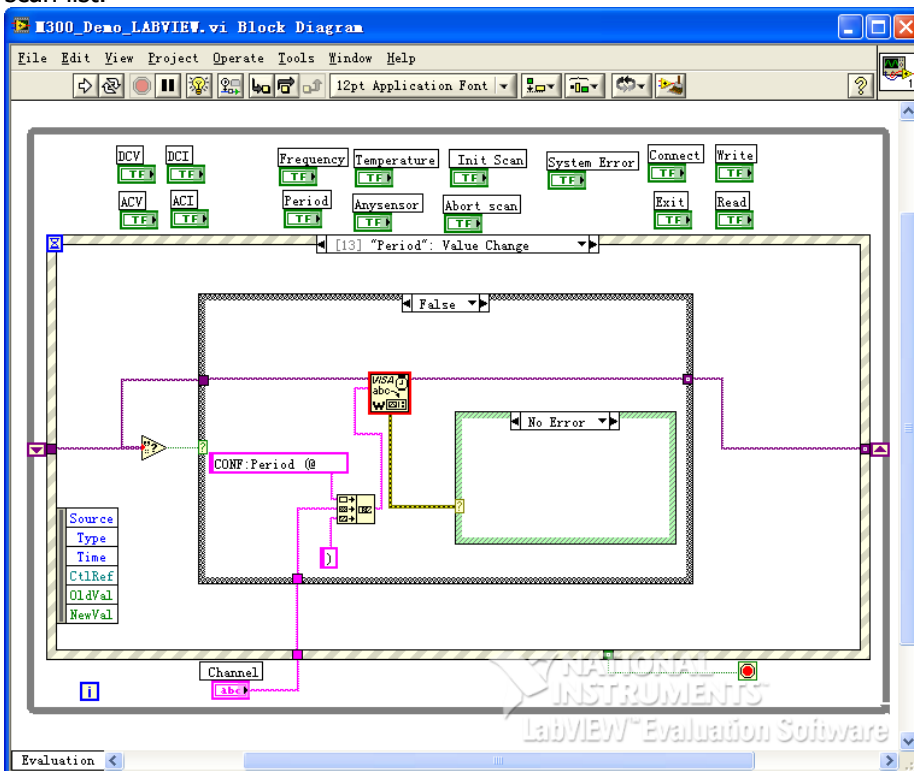

- (9) Configure the specified channels to the Temperature measurement function and overwrite the current scan list.

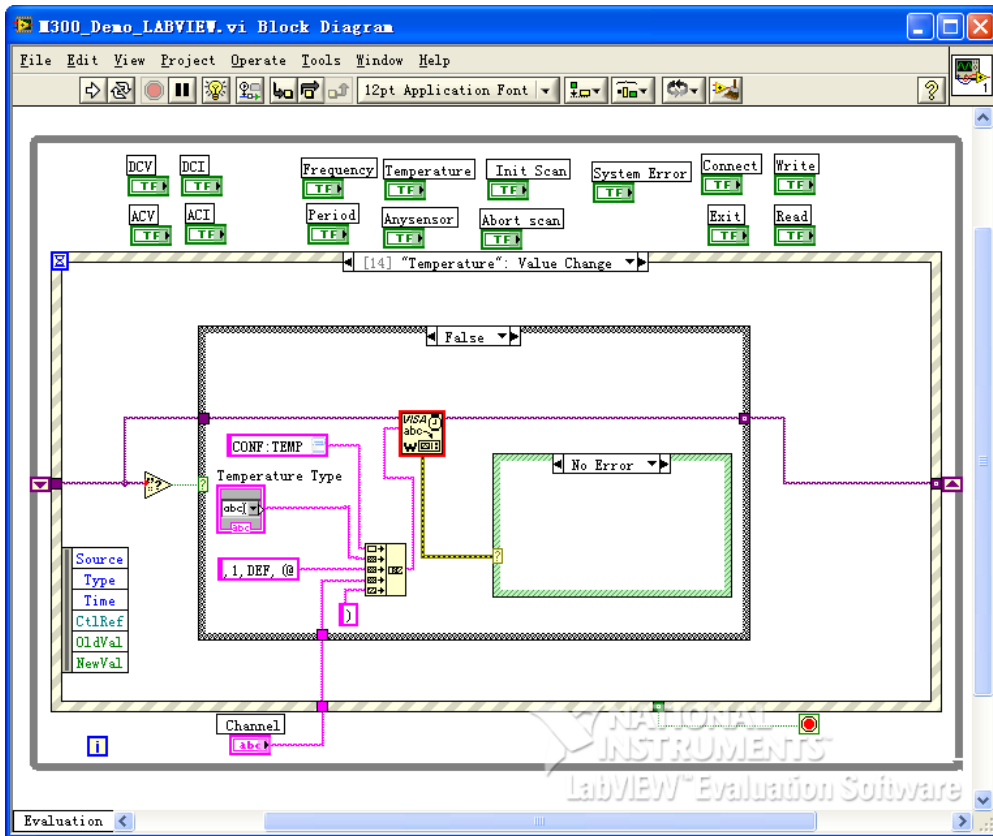

(10) Configure the specified channels to the AnySensor measurement function and overwrite the current scan list.

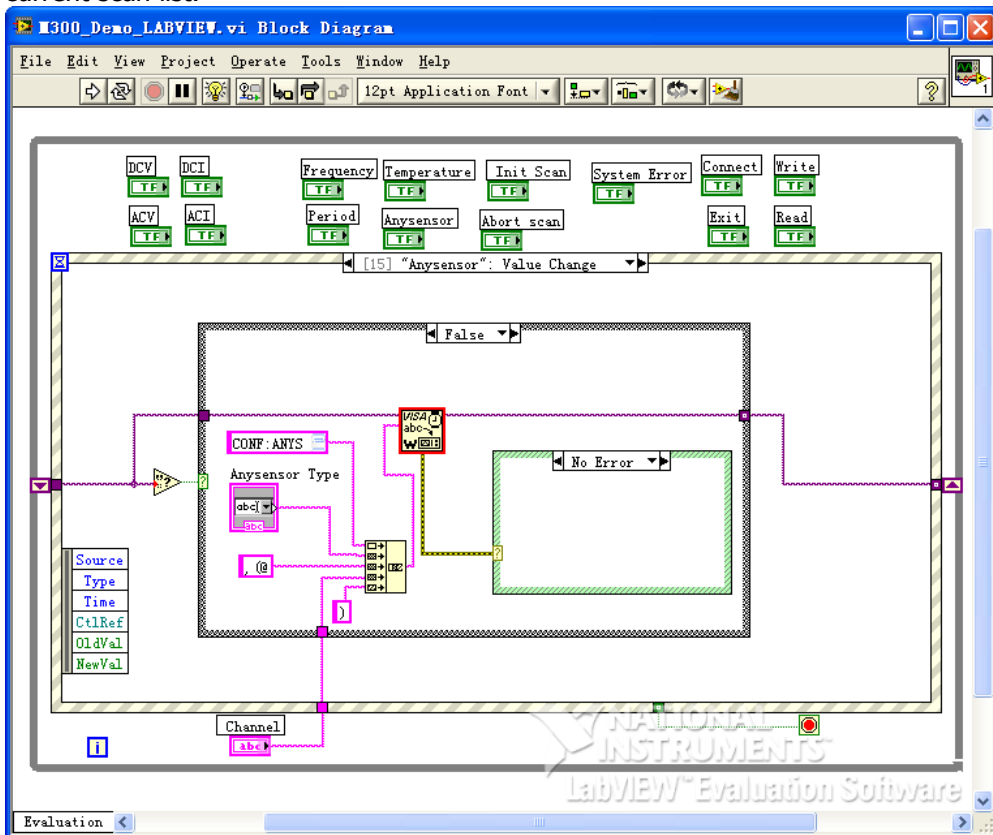

(11) Write operation (including error judgment):

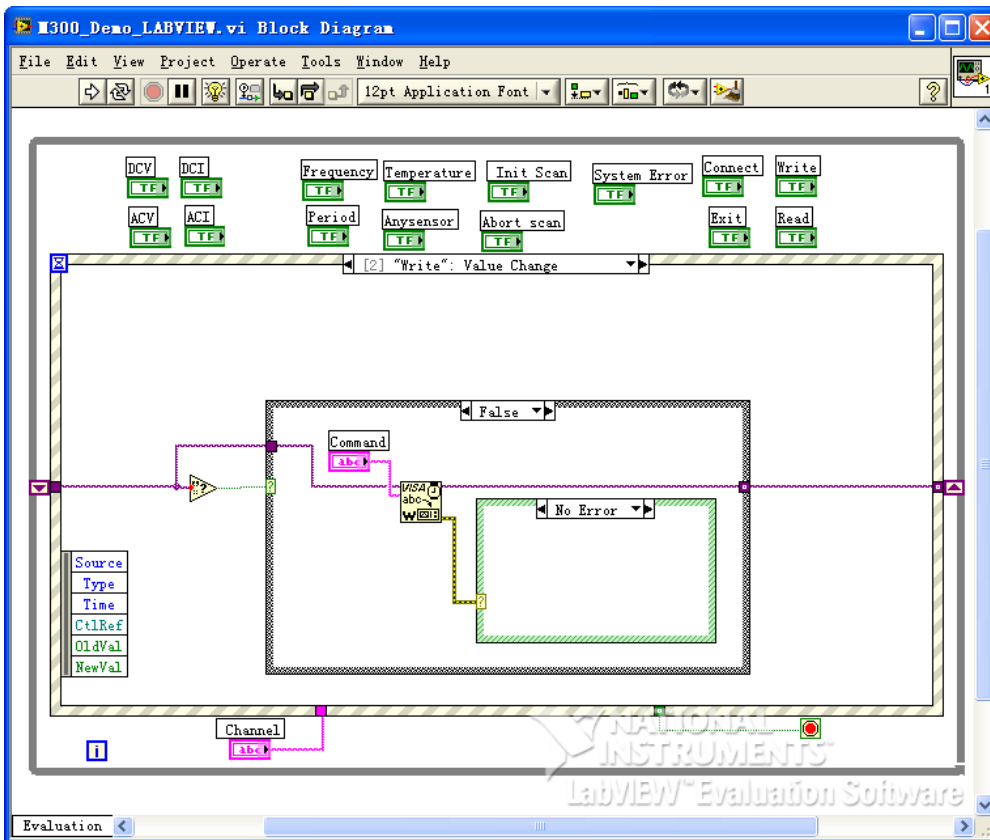
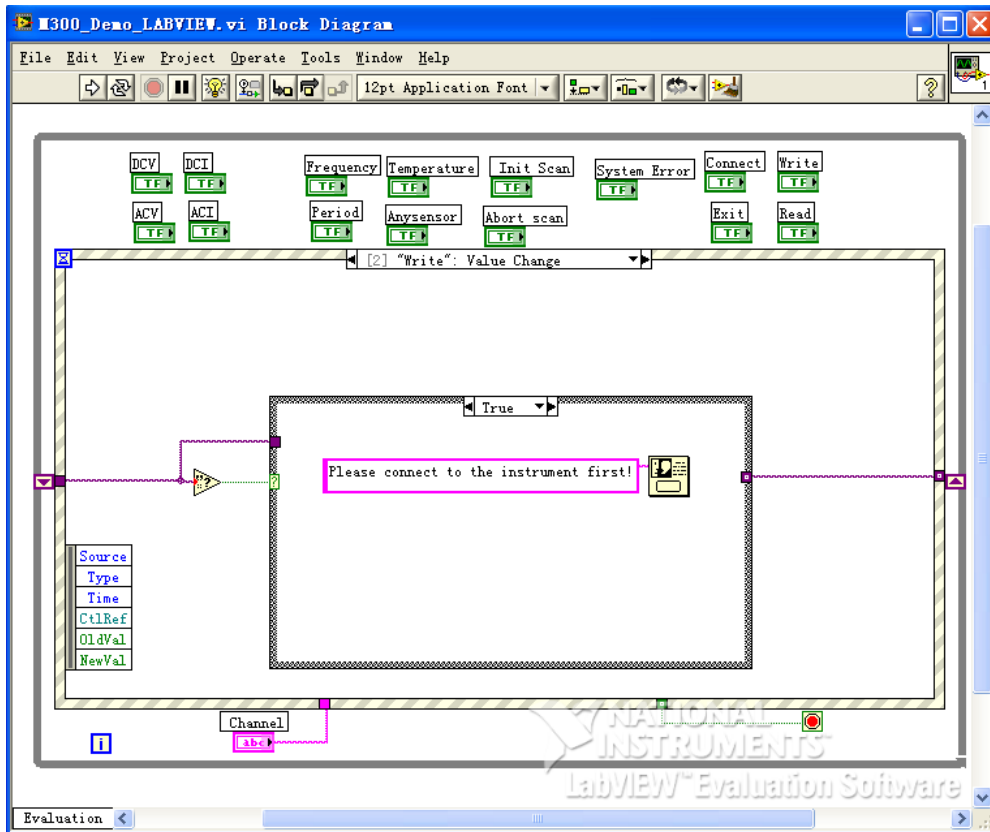

(12) Read operation (including error processing):

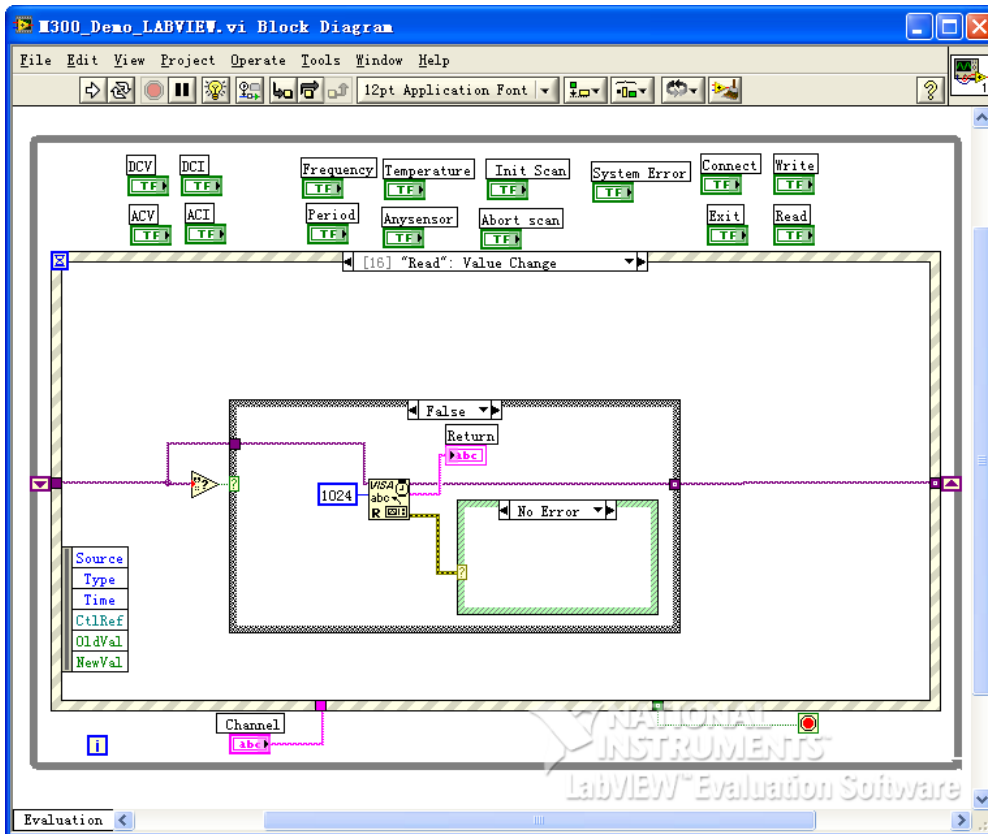

(13) Exit:

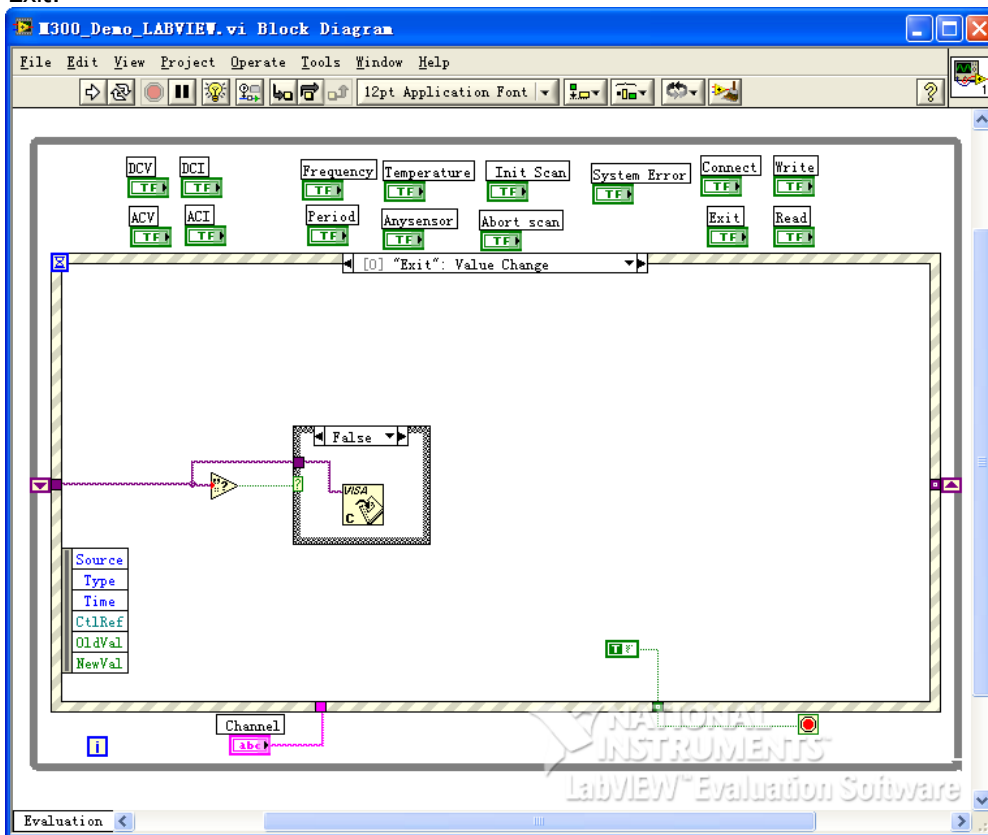

5 Running results.

- 1) Click the **Address** dropdown box and select the VISA resource name; click **Connect** to connect the instrument; enter the command into the **Command** textbox and click **Write** to write the

command into the instrument. If the command is a query command, click **Read** and the return value is displayed in the **Return** textbox.

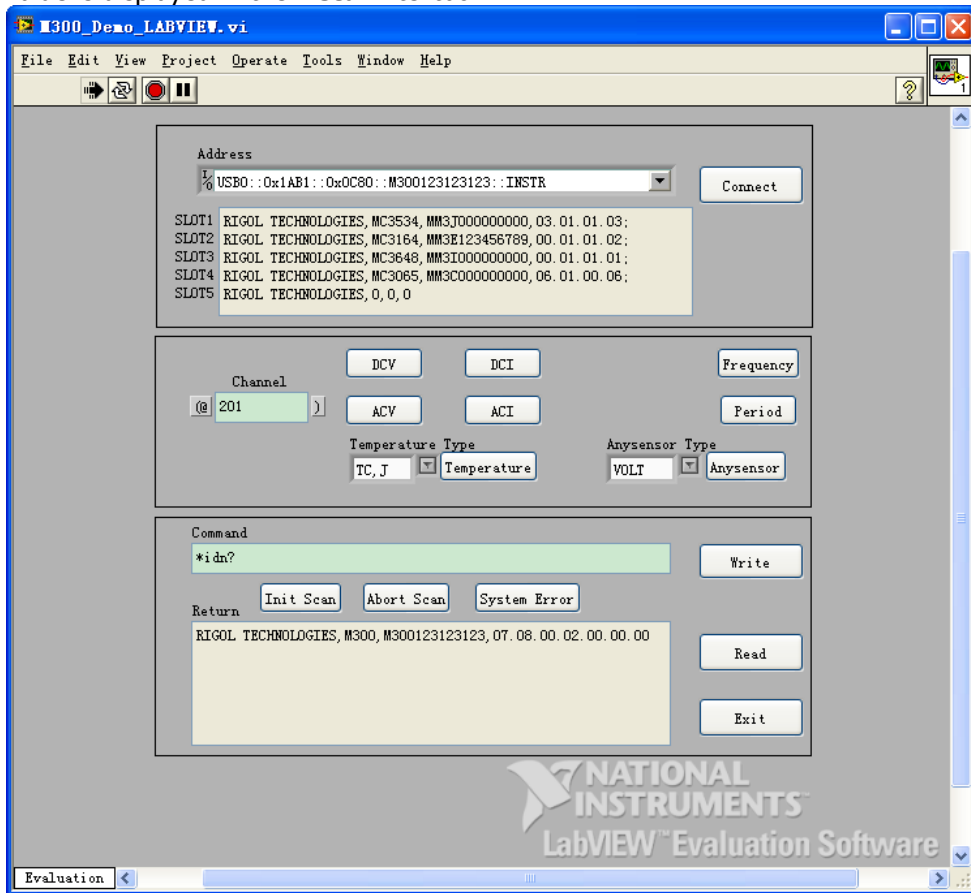

- 2) Run the program. Click the **Address** dropdown box and select the VISA resource name; click **Connect** to connect the instrument; enter the channel number in the **channel** textbox; click any measurement button to configure the specified channels as the corresponding measurement function and overwrite the current scan list.

For example, enter 201:203 n in the **channel** textbox, then select the sensor type from the **Temperature Type** combo box, click the **Temperature** button to make the configuration valid, send the CONF? command to query the configuration of the current scan list. The running results are as shown in the figure below.

The channel formats are as follows.

101 represents channel 01 on the module in Slot1;

101:103 represents channels 01 through 03 on the module in Slot1;

101:103,301 represents channels 01 through 03 on the module in Slot1 and channel 01 on the module in Slot3.

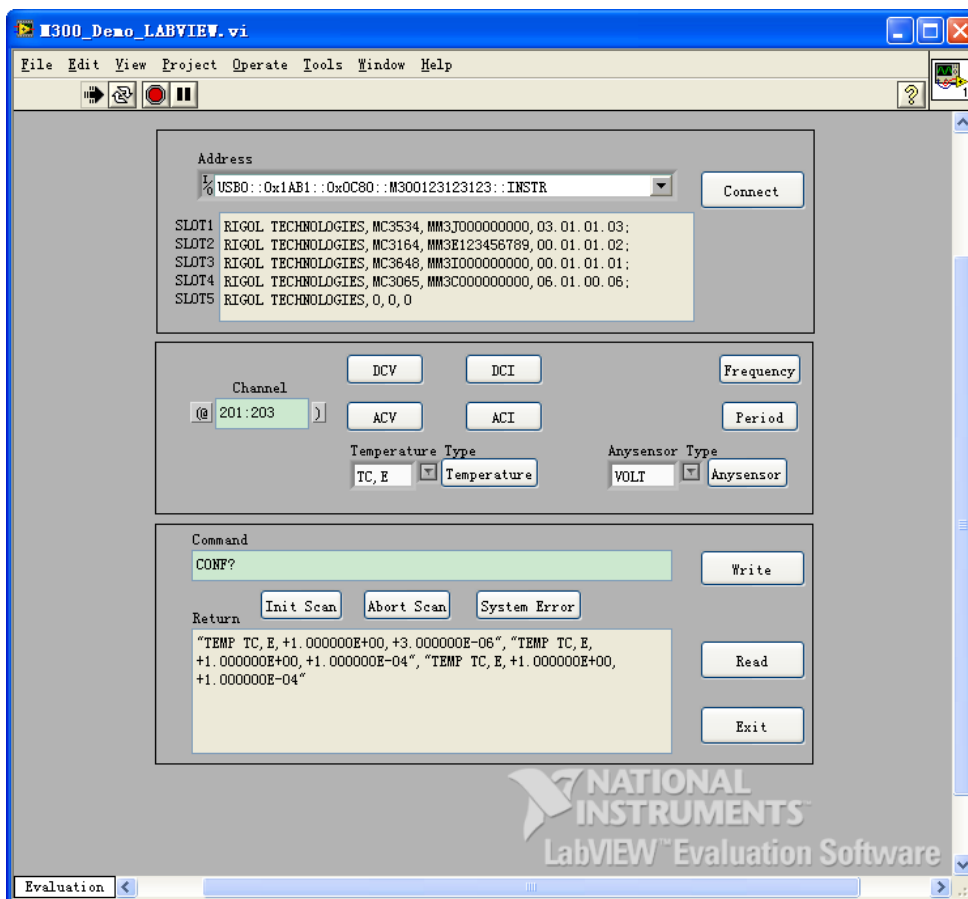

- 3) Click the **InitScan** button to place the instrument in the "wait-for-trigger" state.
- 4) Click the **Abort Scan** button to abort the scan in progress.
- 5) Click the **System Error** button to query a system error. Click the **Read** button to read and clear the error.

# C++ Programming Demo

**The program used in this Demo:** Microsoft Visual Studio 2008

**The functions realized in this Demo:** search for the instrument address, connect the instrument, send command and read the return value.

- 1 Run Microsoft Visual Studio 2008, create a MFC project based on dialog box and name it as M300\_Demo\_VC.
- 2 Add a visa library by adding the statement as follows to the M300\_Demo\_VCDlg.cpp file.  
`#pragma comment (lib, "C:\Program Files\IVI Foundation\VISA\WinNT\lib\msc")`

**Note:**

The path added here is related to the NI-VISA installation path on your PC. Here, the NI-VISA is installed under C:\Program Files\IVI Foundation\VISA.

- 3 Add the **Text, Edit, Button, Radio Button, Combo Box** and **Group Box** controls and the layout is as shown in the figure below.

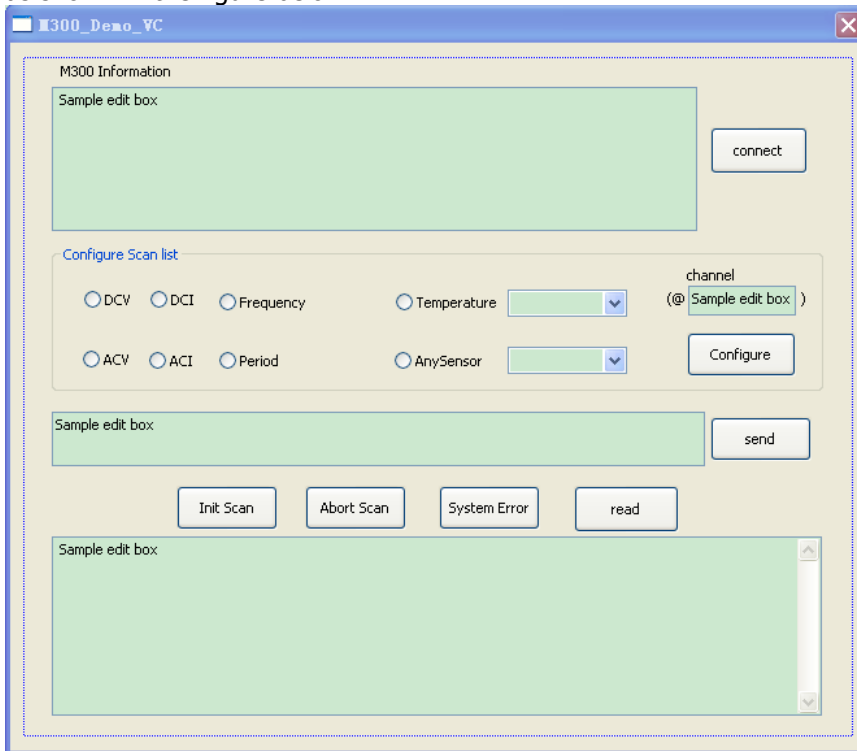

- 4 Click **Project→Add variable** and add the **Edit, Radio Button** and **Combo Box** control variables in the pop-up interface. The explanations of the variables are as shown in the table below.

Control	Variable Type	Variable Name	Explanation
edtM300INfo	CString	strM300Info	M300 Information
edtSendCommand	CString	strSendCommand	Command
edtReadFromM300	CString	strReadFromM300	Return value
edtChannel	CString	strChannel	Channel Number
rbtnDCV	CButton	m_ctrlrbtnDCV	DCV measurement
rbtnDCI	CButton	m_ctrlrbtnDCI	DCI measurement
rbtnACV	CButton	m_ctrlrbtnACV	ACV measurement
rbtnACI	CButton	m_ctrlrbtnACI	ACI measurement
rbtnFrequency	CButton	m_ctrlrbtnFrequency	Frequency measurement
rbtnPeriod	CButton	m_ctrlrbtnPeriod	Period measurement
rbtnTemperature	CButton	m_ctrlrbtnTemperature	Temperature measurement



rbtnAnysensor	CButton	m_ctrlRbtnAnysensor	Anysensor measurement
cmboxSelAnyType	CComboBox	m_ctrlcmboxSelAnyType	Temperature sensor type
cmboxSelTemType	CComboBox	m_ctrlcmboxSelTemType	Anysensor type

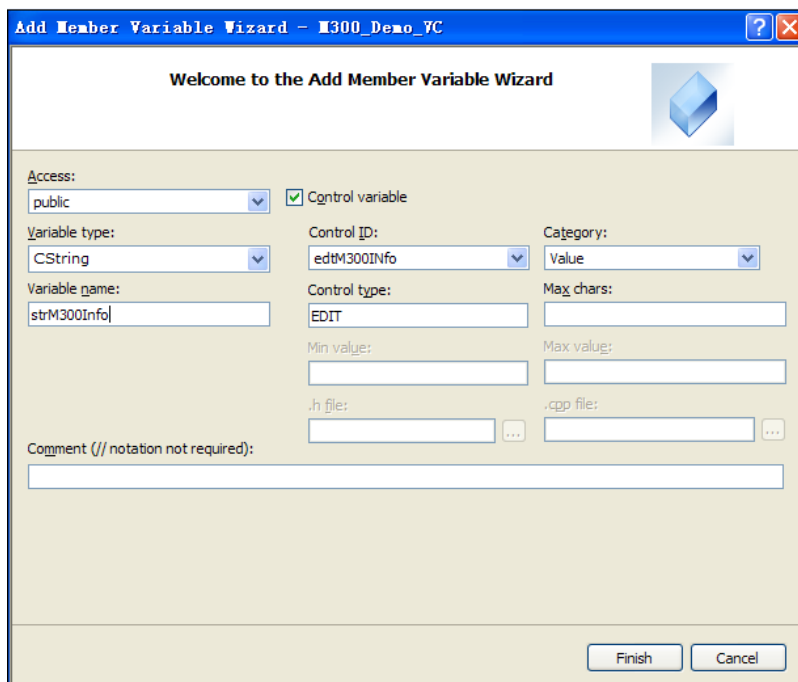

- 5 Initiate the **ComboBox** items by adding the statement as follows to the OnInitDialog() function.

```
//Initiate the cmboxSelAnyType item
m_ctrlcmboxSelAnyType.AddString("VOLT");
m_ctrlcmboxSelAnyType.AddString("CURR");
m_ctrlcmboxSelAnyType.AddString("FRES");
m_ctrlcmboxSelAnyType.SetCurSel(0);
```

```
//Initiate the cmboxSelTemType item
m_ctrlcmboxSelTemType.AddString("TC,J");
m_ctrlcmboxSelTemType.AddString("TC,K");
m_ctrlcmboxSelTemType.AddString("TC,B");
m_ctrlcmboxSelTemType.AddString("TC,E");
m_ctrlcmboxSelTemType.AddString("TC,N");
m_ctrlcmboxSelTemType.AddString("TC,R");
m_ctrlcmboxSelTemType.AddString("TC,S");
m_ctrlcmboxSelTemType.AddString("TC,T");
m_ctrlcmboxSelTemType.AddString("THER,2252");
m_ctrlcmboxSelTemType.AddString("THER,3000");
m_ctrlcmboxSelTemType.AddString("THER,5000");
m_ctrlcmboxSelTemType.AddString("THER,10000");
m_ctrlcmboxSelTemType.AddString("THER,30000");
m_ctrlcmboxSelTemType.AddString("RTD,85");
m_ctrlcmboxSelTemType.AddString("RTD,89");
m_ctrlcmboxSelTemType.AddString("RTD,91");
m_ctrlcmboxSelTemType.AddString("RTD,92");
m_ctrlcmboxSelTemType.AddString("FRTD,85");
m_ctrlcmboxSelTemType.AddString("FRTD,89");
m_ctrlcmboxSelTemType.AddString("FRTD,91");
m_ctrlcmboxSelTemType.AddString("FRTD,92");
m_ctrlcmboxSelTemType.SetCurSel(0);
```

- 6 Encapsulate the write and read operations of VISA.

- 1) Encapsulate the write operation of VISA for easier operation.

```
bool CM300_Demo_VCDlg::InstrWrite(CString strContent)    //write function
{
    ViSession defaultRM,instr;
    ViStatus status;
    ViUInt32 retCount;
    char * SendBuf = NULL;
    char * SendAddr = NULL;
    bool bWriteOK = false;
    CString str;

    //Change the address's data style from CString to char*
    SendAddr = strAddr.GetBuffer(strAddr.GetLength());
    strcpy(SendAddr,strAddr);
    strAddr.ReleaseBuffer();

    //Change the command's data style from CString to char*
    SendBuf = strContent.GetBuffer(strContent.GetLength());
    strcpy(SendBuf,strContent);
    strContent.ReleaseBuffer();

    //open the VISA instrument
    status = viOpenDefaultRM(&defaultRM);
    if (status < VI_SUCCESS)
    {
        AfxMessageBox("No VISA instrument was opened !");
        return false;
    }

    status = viOpen(defaultRM, SendAddr, VI_NULL, VI_NULL, &instr);

    //write command to the instrument
    status = viWrite(instr, (unsigned char *)SendBuf, strlen(SendBuf), &retCount);

    //close the instrument
    status = viClose(instr);
    status = viClose(defaultRM);

    return bWriteOK;
}
```

- 2) Encapsulate the read operation of VISA for easier operation.

```
bool CM300_Demo_VCDlg::InstrRead(CString *pstrResult)    //Read from the instrument
{
    ViSession defaultRM,instr;
    ViStatus status;
    ViUInt32 retCount;
    char * SendAddr = NULL;
    unsigned char RecBuf[MAX_REC_SIZE] ;
    bool bReadOK = false;
    CString str;

    memset(RecBuf,'\0',MAX_REC_SIZE);

    //Change the address's data style from CString to char*
    SendAddr = strAddr.GetBuffer(strAddr.GetLength());
    strcpy(SendAddr,strAddr);
    strAddr.ReleaseBuffer();
    memset(RecBuf,0,MAX_REC_SIZE);
```

```

//open the VISA instrument
status = viOpenDefaultRM(&defaultRM);
if (status < VI_SUCCESS)
{
    // Error Initializing VISA...exiting
    AfxMessageBox("No VISA instrument was opened !");
    return false;
}

//open the instrument
status = viOpen(defaultRM, SendAddr, VI_NULL, VI_NULL, &instr);

//read from the instrument
status = viRead(instr, RecBuf, MAX_REC_SIZE-1, &retCount);

//The operation completed successfully and the END indicator was received (for interfaces that
have END indicators).
if (status == VI_SUCCESS)
{
    (*pstrResult).Format("%s",RecBuf);
}
//The specified termination character was read but no END indicator was received. This
completion code is returned regardless of whether the number of bytes read is equal to count.
else if (status == VI_SUCCESS_TERM_CHAR)
{
    (*pstrResult).Format("%s",RecBuf);
}
//The number of bytes read is equal to count. No END indicator was received and no termination
character was read.
else if (status == VI_SUCCESS_MAX_CNT)
{
    //(*pstrResult).Format("%s",RecBuf);
    *pstrResult = RecBuf;
    *pstrResult = *pstrResult + "\r\n (!!Warning!!The number of bytes transferred is equal to
the requested input count. More data might be available.)";
}
else
{
    *pstrResult = "(!!Warning!! An error occurred!!)";
}

//close the instrument
status = viClose(instr);
status = viClose(defaultRM);
return bReadOK;
}

```

- 7 Add the Button control message response code.

```

1) Connect the instrument.
void CM300_Demo_VCDlg::OnBnClickedbtnconnect()
{
    // TODO: Add your control notification handler code here
    ViStatus status;
    ViSession defaultRM;
    ViString expr = "?*";
    ViPFindList findList = new unsigned long;
    ViPUInt32 retcnt = new unsigned long;
    ViChar instrDesc[1000];
}

```

```

CString strSrc = NULL;
CString strInstr = NULL;
CString strCommand[5] = {"SYST:CTYP? 100","SYST:CTYP? 200","SYST:CTYP?
300","SYST:CTYP? 400","SYST:CTYP? 500"};
CString strM300InfoTemp = "";
CString strSlot = "";
unsigned long i = 0;
bool bFindDP = false;

status = viOpenDefaultRM(&defaultRM);
if (status < VI_SUCCESS)
{
    // Error Initializing VISA...exiting
    MessageBox("No VISA instrument was opened !");
    return ;
}

memset(instrDesc,0,1000);

// Find resource
status = viFindRsrc(defaultRM,expr,findList, retcnt, instrDesc);

for (i = 0;i < (*retcnt);i++)
{
    // Get instrument name
    strSrc.Format("%s",instrDesc);
    strAddr =strSrc;
    InstrWrite("*IDN?");
    ::Sleep(200);
    InstrRead(&strInstr);

    // If the instrument(resource) belongs to the M300 then jump out //from the loop
    strInstr.MakeUpper();
    if (strInstr.Find("M300") >= 0)
    {
        bFindDP = true;
        strM300InfoTemp = strInstr;
        break;
    }
    //Find next instrument
    status = viFindNext(*findList,instrDesc);
}

if (bFindDP == false)
{
    MessageBox("Didn't find any M300!");
}
//Dispaly the M300 information
strM300InfoTemp = strInstr;
for(int i=0 ; i < 5 ;i ++ )
{
    strSlot.Format("%d",i+1);
    InstrWrite( strCommand[i] );
    ::Sleep(100);
    InstrRead(&strInstr);
    strM300InfoTemp = strM300InfoTemp + "\r\n" + "SLOT" +strSlot+": " +strInstr.Mid(19);
}
strM300Info = strM300InfoTemp;

```

```

        UpdateData(false);
    }
2) Write operation.
void CM300_Demo_VCDlg::OnBnClickedbtntsend()
{
    // TODO: Add your control notification handler code here
    UpdateData(true);
    if( strM300Info.IsEmpty() )
    {
        MessageBox("Please connect to the instrument first!");
    }
    if( strSendCommand.IsEmpty() )
    {
        MessageBox("Please input the command first!");
    }
    else
    {
        InstrWrite(strSendCommand);
    }
    UpdateData(false);
}
3) Read operation.
void CM300_Demo_VCDlg::OnBnClickedbtnread()
{
    // TODO: Add your control notification handler code here
    UpdateData(true);
    strReadFromM300.Empty();
    InstrRead(&strReadFromM300);
    UpdateData(false);
}
4) Configure the scan list.
void CM300_Demo_VCDlg::OnBnClickedbtnconfigure()
{
    // TODO: Add your control notification handler code here
    CString strCommand = "CONF:";
    CString strType = "";
    int nIndex = 0;

    UpdateData(true);
    if(strMeasurement == "")
    {
        MessageBox("Please Select one measurement for the specified channels!");
    }
    else
    {
        if(strChannel.IsEmpty())
        {
            MessageBox("Please input the channel number frist!");
        }
        else
        {
            if(strMeasurement == "Temperature" )
            {
                nIndex = m_ctrlcmbboxSelTemType.GetCurSel();
                m_ctrlcmbboxSelTemType.GetLBText(nIndex,strType);
                strCommand = strCommand +strMeasurement + " " + strType + ",1,DEF,"+ "@ "
+ strChannel + ")";
            }
        }
    }
}

```

```

    }
    else if(strMeasurement == "Anysensor" )
    {
        nIndex = m_ctrlcmbboxSelAnyType.GetCurSel();
        m_ctrlcmbboxSelAnyType.GetLBText(nIndex,strType);
        strCommand = strCommand +strMeasurement + " " + strType + ",(@" +
strChannel + ")";
    }
    else
    {
        strCommand = strCommand +strMeasurement + " (@" + strChannel + ")";
    }
    InstrWrite(strCommand);
}
}
UpdateData(false);
}
5) Initialize scan list.
void CM300_Demo_VCDlg::OnBnClickedbtninitscan()
{
    // TODO: Add your control notification handler code here
    CString strCommand = "INIT";
    InstrWrite(strCommand);
}
6) Abort the scan.
void CM300_Demo_VCDlg::OnBnClickedbtnabortscan()
{
    // TODO: Add your control notification handler code here
    CString strCommand = "ABORT";
    InstrWrite(strCommand);
}
7) Query the system error.
void CM300_Demo_VCDlg::OnBnClickedbtnsyserr()
{
    // TODO: Add your control notification handler code here
    CString strCommand = "SYST:Error?";
    InstrWrite(strCommand);
}
8 Add the Radio Button control message response code.
1) Click the rbtnDCV radio button.
void CM300_Demo_VCDlg::OnBnClickedrbtndcv()
{
    // TODO: Add your control notification handler code here
    if (m_ctrlrbtnDCV.GetCheck() == 1)
    {
        strMeasurement = "VOLT:DC";
    }
    else
    {
        strMeasurement = "";
    }
}
2) Click the rbtnDCI radio button.
void CM300_Demo_VCDlg::OnBnClickedrbtndci()
{
    // TODO: Add your control notification handler code here
    if (m_ctrlrbtnDCI.GetCheck() == 1)
    {

```

```

        strMeasurement = "CURR:DC";
    }
    else
    {
        strMeasurement = "";
    }
}
3) Click the rbtnACV radio button.
void CM300_Demo_VCDlg::OnBnClickedrbtnacv()
{
    // TODO: Add your control notification handler code here
    if (m_ctrlrbtnACV.GetCheck() == 1)
    {
        strMeasurement = "VOLT:AC";
    }
    else
    {
        strMeasurement = "";
    }
}
4) Click the rbtnACI radio button.
void CM300_Demo_VCDlg::OnBnClickedrbtnaci()
{
    // TODO: Add your control notification handler code here
    if (m_ctrlrbtnACI.GetCheck() == 1)
    {
        strMeasurement = "CURR:AC";
    }
    else
    {
        strMeasurement = "";
    }
}
5) Click the rbtnFrequency radio button.
void CM300_Demo_VCDlg::OnBnClickedrbtnfrequency()
{
    // TODO: Add your control notification handler code here
    if (m_ctrlrbtnFrequency.GetCheck() == 1)
    {
        strMeasurement = "Frequency";
    }
    else
    {
        strMeasurement = "";
    }
}
6) Click the rbtnPeriod radio button.
void CM300_Demo_VCDlg::OnBnClickedrbtnperiod()
{
    // TODO: Add your control notification handler code here
    if (m_ctrlrbtnPeriod.GetCheck() == 1)
    {
        strMeasurement = "Period";
    }
    else
    {
        strMeasurement = "";
    }
}

```

```

}
7) Click the rbtnTemperature radio button.
void CM300_Demo_VCDlg::OnBnClickedrbtntemperature()
{
    // TODO: Add your control notification handler code here
    if (m_ctrlrbtnTemperature.GetCheck() == 1)
    {
        strMeasurement = "Temperature";
    }
    else
    {
        strMeasurement = "";
    }
}
8) Click the rbtnAnysensor radio button.
void CM300_Demo_VCDlg::OnBnClickedrbtnanysensor()
{
    // TODO: Add your control notification handler code here
    if (m_ctrlrbtnAnysensor.GetCheck() == 1)
    {
        strMeasurement = "Anysensor";
    }
    else
    {
        strMeasurement = "";
    }
}

```

#### 9) Running results.

- 1) Click **Connect** to search for the M300 series Data Acquisition/Switch System and connect it;
- 2) Enter a command into the **Command** textbox, for example, \*IDN?;
- 3) Click **Send** to send the command;
- 4) Click **Read** to read the return value. The running results are as shown in the figure below.

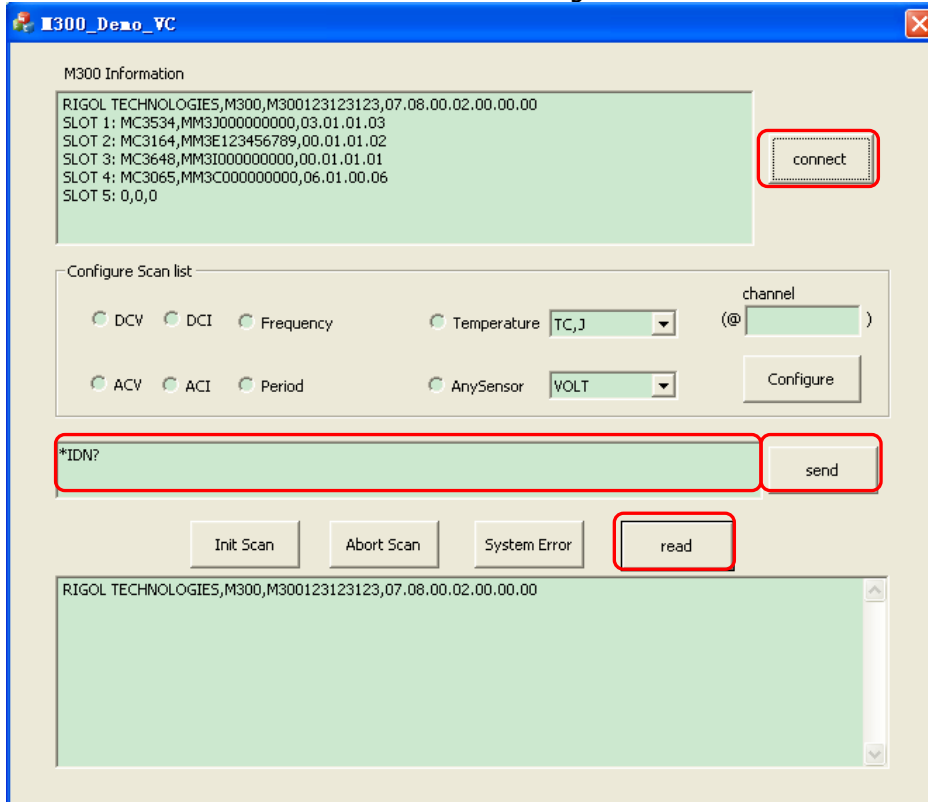



- 5) You can select the desired measurement functions for the specified channels and click the **Configure** button to configure the scan list with the current configuration.

The channel formats are as follows.

101 represents channel 01 on the module in Slot1;

101:103 represents channels 01 through 03 on the module in Slot1;

101:103,301 represents channels 01 through 03 on the module in Slot1 and channel 01 on the module in Slot3.

- 6) Send the "CONF?" command to query the configuration of the current scan list. The running results are as shown in the figure below.

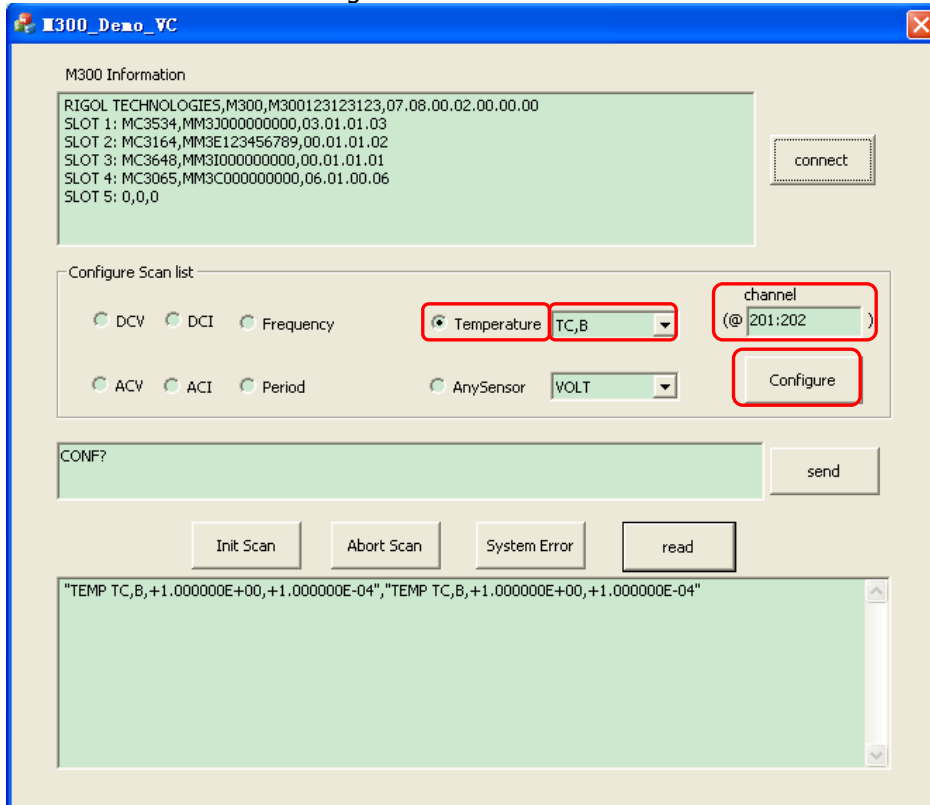

- 7) Click the **InitScan** button to place the instrument in the "wait-for-trigger" state.
- 8) Click the **Abort Scan** button to abort the scan in progress.
- 9) Click the **System Error** button to query a system error. Click the **read** button to read and clear the error.

## C# Programming Demo

**The program used in this Demo:** Microsoft Visual Studio 2008

**The functions realized in this Demo:** search for the instrument address, connect the instrument, send command and read the return value, configure the scan list etc.

1. Run Microsoft Visual Studio 2008, create a C# project based on Windows Form Application and name it as M300\_Demo\_CSharp.
2. Add a visa library by adding the statement as follows to Form1.cs.

```
using System.Runtime.InteropServices;
/*Function:Queries a VISA system to locate the resources associated with a specified interface*/
[DllImport("visa32.dll")]
public static extern Int32 viFindRsrc(Int32 sesn, string expr, ref Int32 vi, ref Int32 retCount, byte[]
Desc);

/*Function:Returns the next resource from the list of resources found during a previous call to
viFindRsrc().*/
[DllImport("visa32.dll")]
public static extern Int32 viFindNext(Int32 vi, byte[] Desc);

/*Function:This function returns a session to the Default Resource Manager resource.*/
[DllImport("visa32.dll")]
public static extern Int32 viOpenDefaultRM(ref Int32 sesn);

/*Function:Opens a session to the specified resource.*/
[DllImport("visa32.dll")]
private static extern Int32 viOpen(Int32 sesn, string viDexc, Int32 mode, Int32 timeout, ref Int32
vi);

/*Function:Closes the specified session, event, or find list.*/
[DllImport("visa32.dll")]
private static extern Int32 viClose(Int32 vi);

/*Function:Converts, formats, and sends the parameters designated by params to the device or
interface as specified by the format string.*/
[DllImport("visa32.dll")]
private static extern Int32 viVPrintf(Int32 vi, string writeFmt, Int32 para);

/*Function:Reads, converts, and formats data using the format specifier. Stores the formatted
data in the parameters (designated by ...).*/
[DllImport("visa32.dll")]
private static extern Int32 viScanf(Int32 vi, string readFmt, byte[] para);
```

**Note:**

Please add the "visa32.dll" file to the current project directory.

3. Add the **Text**, **Edit**, **Button**, **CheckBox**, **ComboBox**, **Label** and **GroupBox** controls and the layout is as shown in the figure below.

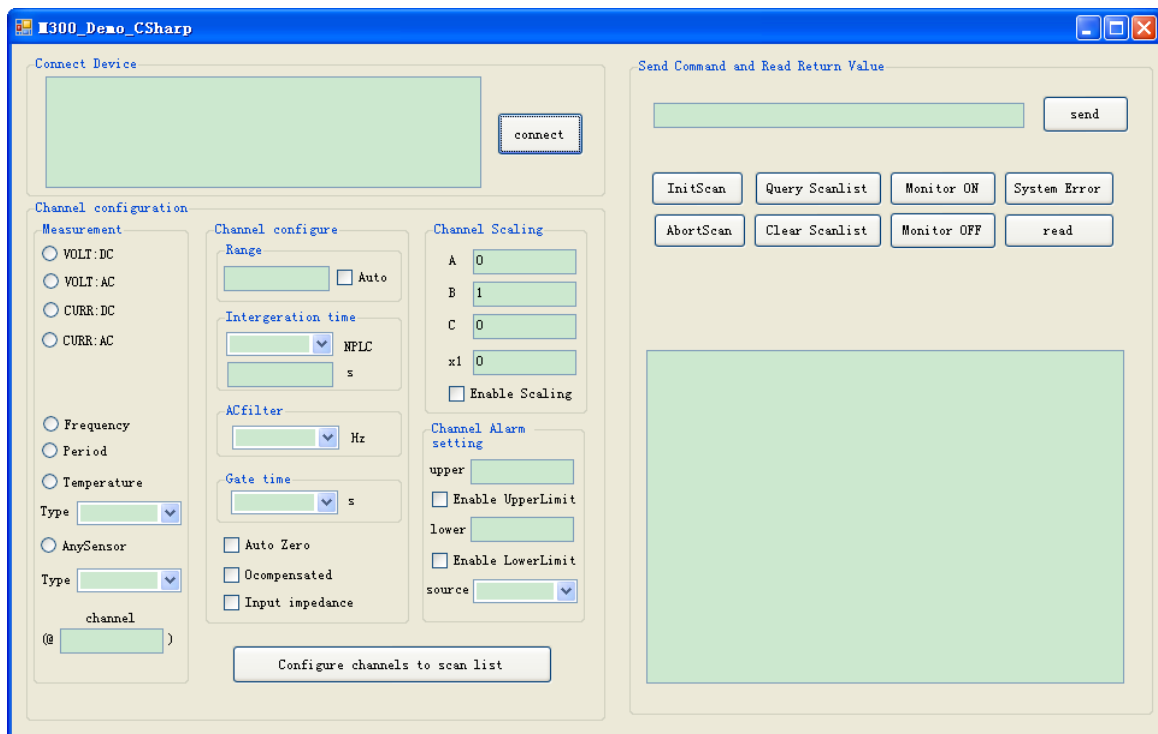

4. Initialize the **ComboBox** items by adding the statement as follows to the Form1 Load event.

```
private void Form1_Load(object sender, EventArgs e)
{
    //Init the NPLC parameter
    cmbboxNPLC.Items.Add("0.02");
    cmbboxNPLC.Items.Add("0.2");
    cmbboxNPLC.Items.Add("1");
    cmbboxNPLC.Items.Add("2");
    cmbboxNPLC.Items.Add("10");
    cmbboxNPLC.Items.Add("20");
    cmbboxNPLC.Items.Add("100");
    cmbboxNPLC.Items.Add("200");
    cmbboxNPLC.Items.Add("");
    //Init the ACfilter parameter
    coboxACFilter.Items.Add("3");
    coboxACFilter.Items.Add("20");
    coboxACFilter.Items.Add("200");
    coboxACFilter.Items.Add("");
    //Init the Gate time parameter
    coboxGateTime.Items.Add("0.001");
    coboxGateTime.Items.Add("0.01");
    coboxGateTime.Items.Add("0.1");
    coboxGateTime.Items.Add("1");
    coboxGateTime.Items.Add("");
    //Init the Alarm Source parameter
    cmbboxSource.Items.Add("ALARm1");
    cmbboxSource.Items.Add("ALARm2");
    cmbboxSource.Items.Add("ALARm3");
    cmbboxSource.Items.Add("ALARm4");
    //Init the Temperature type
    cmbboxTemp.Items.Add("TC,B");
}
```

```

cmboxTemp.Items.Add("TC,E");
cmboxTemp.Items.Add("TC,J");
cmboxTemp.Items.Add("TC,N");
cmboxTemp.Items.Add("TC,R");
cmboxTemp.Items.Add("TC,S");
cmboxTemp.Items.Add("TC,T");
cmboxTemp.Items.Add("THER,2252");
cmboxTemp.Items.Add("THER,3000");
cmboxTemp.Items.Add("THER,5000");
cmboxTemp.Items.Add("THER,10000");
cmboxTemp.Items.Add("THER,30000");
cmboxTemp.Items.Add("RTD,85");
cmboxTemp.Items.Add("RTD,89");
cmboxTemp.Items.Add("RTD,91");
cmboxTemp.Items.Add("RTD,92");
cmboxTemp.Items.Add("FRTD,85");

```

```
//Init the Anysensor type
```

```

cmboxAnySensor.Items.Add("VOLT");
cmboxAnySensor.Items.Add("CURR");
cmboxAnySensor.Items.Add("FRES");
cmboxAnySensor.Items.Add("FREQ");
}

```

5. Encapsulate the write and read operations of VISA.

1) Encapsulate the write operation of VISA for easier operation.

```

private void Device_Send(string Cmd)
{
    string strCmd = Cmd + '\n';
    long IDevReturn = 0;

    IDevReturn = viVPrintf(g_i32VisaIO, strCmd, 0);
    if (IDevReturn < 0)
    {
        MessageBox.Show(this, "Failed to send commands!", "Tip", MessageBoxButtons.OK,
        MessageBoxIcon.Information);
    }
    else
    { }
}

```

2) Encapsulate the read operation of VISA for easier operation.

```

private string ReadFromDev()
{
    string strReturn = "";
    byte[] temp = new byte[10000];
    long IDevReturn = 0;

    IDevReturn = viScanf(g_i32VisaIO, "%t", temp);
    if (IDevReturn < 0)
    {
        MessageBox.Show(this, "Read fail! ", "Tip", MessageBoxButtons.OK,
        MessageBoxIcon.Information);
        return strReturn;
    }
    else
    { }

    strReturn = Encoding.ASCII.GetString(temp);
}

```

```

        if (strReturn.IndexOf('\n') != -1)
        {
            strReturn = strReturn.Substring(0, strReturn.IndexOf('\n'));
        }
        else
        { }
        return strReturn;
    }
}

6. Add the Click event of the button controls.
1) Connect the instrument.
    //Define the Global Variables of visa
    byte[] g_bpRsrcName; //Resource name byte array
    Int32 g_i32RsrcManager; //Resource manager identifier
    Int32 g_i32VisaIO; //Dialogue channel
    string g_strCurrentDevice; //Current device VISA Address
    public string[] DevResource = new string[10]; //Used to store Device resources
    public string DevInfoReturn = ""; //The returned device information

    private void btnConnect_Click(object sender, EventArgs e)
    {
        string[] CMD_SYST_INFO = {"SYST:CTYP? 100", "SYST:CTYP? 200", "SYST:CTYP? 300",
        "SYST:CTYP? 400", "SYST:CTYP? 500" };
        string[] strCMDReturn = new string[6];
        Int32 intFuncReturn = 0;
        string strSlotTemp = "";
        string strTemp = "";
        string CurrentDeviceM300 = "";
        g_bpRsrcName = new byte[200];
        Int32 fList = 0;
        Int32 DeviceNum = 0;
        Int32 retCount = 0;

        // Find Device
        viOpenDefaultRM(ref g_i32RsrcManager);
        retCount = viFindRsrc(g_i32RsrcManager, "?*", ref fList, ref DeviceNum,
g_bpRsrcName);
        if (DeviceNum > 0)
        {
            for (int i = 0; i < DeviceNum; i++)
            {
                strTemp = Encoding.ASCII.GetString(g_bpRsrcName);
                g_strCurrentDevice = strTemp.Substring(0, strTemp.IndexOf('\0'));
                DevResource[i] = g_strCurrentDevice;
                retCount = viFindNext(fList, g_bpRsrcName);
                if (retCount >= 0)
                {
                    i++;
                    strTemp = Encoding.ASCII.GetString(g_bpRsrcName);
                    g_strCurrentDevice = strTemp.Substring(0, strTemp.IndexOf('\0'));
                    DevResource[i] = g_strCurrentDevice;
                }
            }
        }
        else
        {
            MessageBox.Show(this, "Din't found any instrument! ", "Tip",

```

```

MessageBoxButtons.OK, MessageBoxIcon.Information);
    txtM300Info.Text = "";
    return;
}

// judge whether the instrument is M300 or not and dispaly M300 Information
for (int j = 0; (j < 10) && (DevResource[j] != null); j++)
{
    if (DevResource[j].Substring(22, 4) == "M300")
    {
        CurrentDeviceM300 = DevResource[j];
        break;
    }
}
if (CurrentDeviceM300.Substring(22, 4) == "M300")
{
    intFuncReturn = viOpen(g_i32RsrcManager, CurrentDeviceM300, 0, 3000, ref
g_i32VisaIO);
    if (intFuncReturn >= 0)
    {
        Device_Send("*IDN?");
        DevInfoReturn = ReadFromDev();
        try
        {
            if (DevInfoReturn.Substring(0, 23) == "RIGOL TECHNOLOGIES,M300")
            {
                DevInfoReturn = DevInfoReturn + "\r\n";
                for (int i = 0; i < 5; i++)
                {
                    strSlotTemp = Convert.ToString(i + 1);
                    Device_Send(CMD_SYST_INFO[i]);
                    strCMDReturn[i] = ReadFromDev();
                    DevInfoReturn = DevInfoReturn + "Slot" + strSlotTemp + ":" +
strCMDReturn[i].Substring(19) + "\r\n";
                }
                txtM300Info.Text = DevInfoReturn;
            }
            else
            {
                viClose(g_i32VisaIO);
                MessageBox.Show(this, "Not RIGOL M300! ", "Message",
MessageBoxButtons.OK, MessageBoxIcon.Information);
                this.Refresh();
            }
        }
        catch
        {
            MessageBox.Show("The M300 information is not correct! ", "Tip",
MessageBoxButtons.OK, MessageBoxIcon.Information);
        }
        Device_Send("*CLS");
    }
}
else
{
    viClose(g_i32VisaIO);
    MessageBox.Show(this, "Not RIGOL M300! ", "Message", MessageBoxButtons.OK,

```

```

MessageBoxIcon.Information);
    }
}
2) Configure the specified channels and add them into the scan list.
private void btnChConfOK_Click(object sender, EventArgs e)
{
    string strCommand="*IDN?";
    string strMeasurement = "";
    string strReturn = "";
    string strChNum = "";
    int s32pos = 0;
    bool bMeasIsSuit = false;
    string[] strScanList;
    //make sure M300 is connected to PC
    try
    {
        Device_Send(strCommand);
        strReturn = ReadFromDev();
        if (strReturn == "")
        {
            throw new ArgumentNullException();
        }
    }
    catch
    {
        MessageBox.Show("Please make sure the M300 was connected");
        return;
    }
    //update scanlist and save the former channels of the scanlist
    strCommand = "ROUT:SCAN?";
    Device_Send(strCommand);
    Thread.Sleep(300);
    strReturn = ReadFromDev();
    s32pos = strReturn.IndexOf("@");
    strReturn = strReturn.Substring(s32pos + 1);
    strReturn = strReturn.Remove(strReturn.LastIndexOf(" "), 1);
    if (strReturn == "")
    {
        strChNum = strReturn;
    }
    else
    {
        strChNum = strReturn + ",";
    }
    if (txtChannels.Text != "")
    {
        //Configure DCV/DCI measurement
        if (rbtnDCV.Checked == true || rbtnDCI.Checked == true)
        {
            if (rbtnDCV.Checked == true)
            {
                strMeasurement = "VOLT";
            }
            else
            {
                strMeasurement = "CURR";
            }
            //configure measurement

```

```

strCommand = "CONF:" + strMeasurement + " (@" + txtChannels.Text + ")";
Device_Send(strCommand);
//configure range
if (chkRangeAuto.Checked == true || txtRange.Text != "")
{
    if (chkRangeAuto.Checked == true)
    {
        strCommand = strMeasurement + ":RANG:AUTO ON";
    }
    else
    {
        strCommand = strMeasurement + ":RANG " + txtRange.Text;
    }
    strCommand = strCommand + ",(@" + txtChannels.Text + ")";
    Device_Send(strCommand);
}
else {}
//configure intergeration time
if (cmbxNPLC.Text != "" || txtIntertime.Text != "")
{
    if (cmbxNPLC.Text != "")
    {
        strCommand = strMeasurement + ":NPLC " + cmbxNPLC.Text;
    }
    else
    {
        strCommand = strMeasurement + ":APER " + txtIntertime.Text;
    }
    strCommand = strCommand + ",(@" + txtChannels.Text + ")";
    Device_Send(strCommand);
}
else {}
//configure auto az
if (chkAZ.Checked == true)
{
    strCommand = "ZERO:AUTO ON";
    strCommand = strCommand + ",(@" + txtChannels.Text + ")";
    Device_Send(strCommand);
}
//configure Input impedance
if (rbtnDCV.Checked == true)
{
    if (chkInputimp.Checked == true)
    {
        strCommand = "INP:IMP:AUTO ON," + "(@" + txtChannels.Text +
");
        Device_Send(strCommand);
    }
}
}
//Configure ACV/ACI mesurement
else if (rbtnACV.Checked == true || rbtnACI.Checked == true)
{
    if (rbtnACV.Checked == true)
    {
        strMeasurement = rbtnACV.Text;
    }
    else

```



```

{
    strMeasurement = rbtnACI.Text;
}
//configure measurement
strCommand = "CONF:" + strMeasurement + " (@" + txtChannels.Text + ")";
Device_Send(strCommand);
//configure range
if (chkRangeAuto.Checked == true || txtRange.Text != "")
{
    if (chkRangeAuto.Checked == true)
    {
        strCommand = strMeasurement + ":RANG:AUTO ON";
    }
    else
    {
        strCommand = strMeasurement + ":RANG " + txtRange.Text;
    }
    strCommand = strCommand + ",(@" + txtChannels.Text + ")";
    Device_Send(strCommand);
}
else { }
//configure ACFilter
if (coboxACFilter.Text != "")
{
    strCommand = strMeasurement + ":BAND " + coboxACFilter.Text;
    strCommand = strCommand + ",(@" + txtChannels.Text + ")";
    Device_Send(strCommand);
}
else { }
}
//Configure Frequency/period mesurement
else if (rbtnFrequency.Checked == true || rbtnPeriod.Checked == true)
{
    if (rbtnFrequency.Checked == true)
    {
        strMeasurement = "FREQ";
    }
    else
    {
        strMeasurement = "PER";
    }

    //configure measurement
    strCommand = "CONF:" + strMeasurement + " (@" + txtChannels.Text + ")";
    Device_Send(strCommand);
    //configure range
    if (chkRangeAuto.Checked == true && txtRange.Text != "")
    {
        if (chkRangeAuto.Checked == true)
        {
            strCommand = strMeasurement + "VOLT:RANG:AUTO ON";
        }
        else
        {
            strCommand = strMeasurement + "VOLT:RANG " + txtRange.Text;
        }
        strCommand = strCommand + ",(@" + txtChannels.Text + ")";
        Device_Send(strCommand);
    }
}

```

```

    }
    else { }
    //configure ACFilter
    if (coboxACFilter.Text != "")
    {
        strCommand = strMeasurement + ":RANG:LOW " + coboxACFilter.Text;
        strCommand = strCommand + ",(@ " + txtChannels.Text + ")";
        Device_Send(strCommand);
    }
    else { }
    //configure Gate time
    if (coboxGateTime.Text != "")
    {
        strCommand = strMeasurement + ":APER " + coboxGateTime.Text;
        strCommand = strCommand + ",(@ " + txtChannels.Text + ")";
        Device_Send(strCommand);
    }
    else { }
}
//Configure Temperature measurement
else if (rbtnTemp.Checked == true)
{
    if (cmbTemp.Text != "")
    {
        strMeasurement = "TEMP";
        strCommand = "CONF:TEMP " + cmbTemp.Text + ",1,DEF," + "(@" +
txtChannels.Text + ")";
        Device_Send(strCommand);
        //configure intergeration time
        if (cmbNPLC.Text != "" || txtIntertime.Text != "")
        {
            if (cmbNPLC.Text != "")
            {
                strCommand = strMeasurement + ":NPLC " + cmbNPLC.Text;
            }
            else
            {
                strCommand = strMeasurement + ":APER " + txtIntertime.Text;
            }
            strCommand = strCommand + ",(@ " + txtChannels.Text + ")";
            Device_Send(strCommand);
        }
        else { }
        //configure AZ/Ocompensated
        if (cmbTemp.Text.Substring(0, 2) == "TC" ||
cmbTemp.Text.Substring(0, 2) == "TH")
        {
            //configure auto az
            if (chkAZ.Checked == true)
            {
                strCommand = "ZERO:AUTO ON";
                strCommand = strCommand + ",(@ " + txtChannels.Text + ")";
                Device_Send(strCommand);
            }
        }
        else if (cmbTemp.Text.Substring(0, 2) == "RT" ||
cmbTemp.Text.Substring(0, 2) == "FR")
        {

```

```

//configure auto az
if (chkAZ.Checked == true)
{
    strCommand = "ZERO:AUTO ON";
    strCommand = strCommand + ",(@" + txtChannels.Text + ")";
    Device_Send(strCommand);
}
//configure Ocompensated
if (chkOcomp.Checked == true)
{
    strCommand = strMeasurement + ":OCOM ON";
    strCommand = strCommand + ",(@" + txtChannels.Text + ")";
    Device_Send(strCommand);
}
}
else
{}
}
else
{
    MessageBox.Show("please Select Temperature type");
    return;
}
}
//Configure Anysensor mesurement
else if (rbtnAnySensor.Checked == true)
{
    if (cmbxAnySensor.Text != "")
    {
        strMeasurement = "SENSOR";
        strCommand = "CONF:AnySensor " + cmbxAnySensor.Text + ",(@" +
txtChannels.Text + ")";
        Device_Send(strCommand);
        if (cmbxAnySensor.Text != "FREQ")
        {
            //Configure the intergeration time
            if (cmbxNPLC.Text != "" || txtIntertime.Text != "")
            {
                if (cmbxNPLC.Text != "")
                {
                    strCommand = strMeasurement + ":" +
cmbxAnySensor.Text + ":NPLC " + cmbxNPLC.Text;
                }
                else
                {
                    strCommand = strMeasurement + ":" +
cmbxAnySensor.Text + ":APER " + txtIntertime.Text;
                }
                strCommand = strCommand + ",(@" + txtChannels.Text + ")";
                Device_Send(strCommand);
            }
            //Configure the auto zero
            if (cmbxAnySensor.Text == "VOLT" || cmbxAnySensor.Text ==
"CURR")
            {
                if (chkAZ.Checked == true)
                {
                    strCommand = "ZERO:AUTO ON";

```

```

        strCommand = strCommand + ",(@" + txtChannels.Text +
");";
        Device_Send(strCommand);
    }
    if (cmbxAnySensor.Text == "VOLT")
    {
        //configure Input impedance for DCI
        if (rbtnDCV.Checked == true)
        {
            if (chkInputimp.Checked == true)
            {
                strCommand = "INP:IMP:AUTO ON," + "(@" +
txtChannels.Text + ")";
                Device_Send(strCommand);
            }
        }
    }
}
else
{
    //configure ACFilter for frequency
    if (coboxACFilter.Text != "")
    {
        strCommand = strMeasurement + ":" + cmbxAnySensor.Text +
":RANG:LOW " + coboxACFilter.Text;
        strCommand = strCommand + ",(@" + txtChannels.Text + ")";
        Device_Send(strCommand);
    }
}
else
{
    MessageBox.Show("please Select Anysensor type");
}
}
else
{
    MessageBox.Show("please Select Measurement");
    return;
}
//Configure Scaling
if (chkEnableScaling.Checked == true)
{
    // Set the square parameter of scaling
    strCommand = "CALC:SCAL:SQU " + txtA.Text + ",(@" + txtChannels.Text +
");";
    Device_Send(strCommand);
    // Set the gain parameter of scaling
    strCommand = "CALC:SCAL:GAIN " + txtB.Text + ",(@" + txtChannels.Text +
");";
    Device_Send(strCommand);
    // Set the offset parameter of scaling
    strCommand = "CALC:SCAL:OFFS " + txtC.Text + ",(@" + txtChannels.Text +
");";
    Device_Send(strCommand);
    // Set the constant parameter of scaling
    strCommand = "CALC:SCAL:CONS " + txtX1.Text + ",(@" + txtChannels.Text +

```

```

    ");
        Device_Send(strCommand);
        // Enable the function of scaling
        strCommand = "CALC:SCAL:STAT ON" + ",(@" + txtChannels.Text + ")";
        Device_Send(strCommand);
    }
    else { }
    //Configure Upper Alarm
    if (chkEnaUpperLimit.Checked == true)
    {
        if (txtUpper.Text != "")
        {
            strCommand = "CALC:LIM:UPP " + txtUpper.Text + ",(@" +
txtChannels.Text + ")";
            Device_Send(strCommand);
            strCommand = "CALC:LIM:UPP:STAT ON" + ",(@" + txtChannels.Text +
    ");
            Device_Send(strCommand);
        }
        else
        {
            MessageBox.Show("please input the upper limit");
        }
    }
    //Configure Lower Alarm
    if (chkEnalowerLimit.Checked == true)
    {
        if (txtLower.Text != "")
        {
            strCommand = "CALC:LIM:LOW " + txtLower.Text + ",(@" +
txtChannels.Text + ")";
            Device_Send(strCommand);
            strCommand = "CALC:LIM:LOW:STAT ON" + ",(@" + txtChannels.Text +
    ");
            Device_Send(strCommand);
        }
        else
        {
            MessageBox.Show("please input the lower limit");
        }
    }
    //Configure Alarm Channel
    if(cmboxSource.Text != "")
    {
        strCommand = "OUTP:" + cmboxSource.Text + ":SOUR " + "(@" +
txtChannels.Text + ")";
        Device_Send(strCommand);
    }
    //Confirm the measurement is same with the specified measurement for all of the
specified channels
    strCommand = "CONF? " + "(@" + txtChannels.Text + ")";
    Device_Send(strCommand);
    Thread.Sleep(500);
    strReturn = ReadFromDev();
    strScanList = strReturn.Split(' ');
    // the specified measurement is not suit for the specified channels
    if (strReturn == "")
    {

```

```

        MessageBox.Show("Error:+305,Not able to perform requested operation");
        return;
    }
    // the specified measurement is not suit for the specified channels
    else
    {
        for (int i = 0; i < strScanList.Length-1; i++)
        {
            if (strScanList[i].Contains(strMeasurement))
            {
                bMeasIsSuit = true;
            }
            else
            {
                bMeasIsSuit = false;
                break;
            }
        }
        // the specified measurement is suit for the specified channels
        if (bMeasIsSuit == true)
        {
            // Add the former channels and the specified channels to the scan list.
            strChNum = strChNum + txtChannels.Text;
            strCommand = "ROUT:SCAN " + "@" + strChNum + ";";
            Device_Send(strCommand);
            Thread.Sleep(300);
        }
        else
        {
            MessageBox.Show("Error:+305,Not able to perform requested
operation");
            return;
        }
    }
}
else
{
    MessageBox.Show("please input channel number");
}
}
}
3) Send command.
private void btnSend_Click(object sender, EventArgs e)
{
    string strCommand = "*IDN?";
    string strReturn = "";
    //make sure M300 is connected to PC
    try
    {
        Device_Send(strCommand);
        strReturn = ReadFromDev();
        if (strReturn == "")
        {
            throw new ArgumentNullException ();
        }
    }
    catch
    {
        MessageBox.Show("Please make sure the M300 was connected");
    }
}

```

```

        return;
    }
    if (txtSendCommand.Text != "")
    {
        Device_Send(txtSendCommand.Text);
    }
    else
    {
        MessageBox.Show("Please input command", "Tip", MessageBoxButtons.OK,
        MessageBoxIcon.Information);
    }
}
4) Initiate a scan.
private void btnInitScan_Click(object sender, EventArgs e)
{
    string strCommand = "INIT";
    Device_Send(strCommand);
}
5) Query the configuration of the scan list.
private void btnQueryScanlist_Click(object sender, EventArgs e)
{
    string strCommand = "*IDN?";
    string strReturn = "";
    //make sure M300 is connected to PC
    try
    {
        Device_Send(strCommand);
        strReturn = ReadFromDev();
        if (strReturn == "")
        {
            throw new ArgumentNullException();
        }
    }
    catch
    {
        MessageBox.Show("Please make sure the M300 was connected");
        return;
    }

    strCommand = "CONF?";
    Device_Send(strCommand);
    Thread.Sleep(300);
    strReturn = ReadFromDev();
    txtReadFromM300.Text = strReturn;
}
6) Enable the monitor mode.
private void btnMonitorON_Click(object sender, EventArgs e)
{
    string strCommand = "ROUTE:MON:STAT ON";
    Device_Send(strCommand);
}
7) Disable the monitor mode.
private void btnMonitorOFF_Click(object sender, EventArgs e)
{
    string strCommand = "ROUTE:MON:STAT OFF";
    Device_Send(strCommand);
}
8) Query the system error.

```

```

private void btnSysError_Click(object sender, EventArgs e)
{
    string strCommand = "*IDN?";
    string strReturn = "";
    //make sure M300 is connected to PC
    try
    {
        Device_Send(strCommand);
        strReturn = ReadFromDev();
        if (strReturn == "")
        {
            throw new ArgumentNullException();
        }
    }
    catch
    {
        MessageBox.Show("Please make sure the M300 was connected");
        return;
    }
    strCommand = "SYST:ERR?";
    Device_Send(strCommand);
    Thread.Sleep(100);
    strReturn = ReadFromDev();
    txtReadFromM300.Text = strReturn;
}

```

- 9) Read the return value.

```

private void btnRead_Click(object sender, EventArgs e)
{
    string strReturn = "";
    strReturn = ReadFromDev();
    txtReadFromM300.Text = strReturn;
}

```

7. Add the MouseDown event of the **cmboxScanlistComboBox** controls.

```

private void cmbScanlist_MouseDown(object sender, MouseEventArgs e)
{
    string strCommand = "*IDN?";
    string strReturn = "";
    int s32pos = 0;
    string[] strScanList;
    int s32SizeofScanlist = 0;

    //make sure M300 is connected to PC
    try
    {
        Device_Send(strCommand);
        strReturn = ReadFromDev();
        if (strReturn == "")
        {
            throw new ArgumentNullException();
        }
    }
    catch
    {
        MessageBox.Show("Please make sure the M300 was connected");
        return;
    }
}

```

//Query the channels of the scan list and add scan list to cmbScanlist



```

        cmbxScanlist.Items.Clear();
        strCommand = "ROUT:SCAN?";
        Device_Send(strCommand);
        Thread.Sleep(300);
        strReturn = ReadFromDev();
        s32pos = strReturn.IndexOf("@");
        strReturn = strReturn.Substring(s32pos + 1);
        strReturn = strReturn.Remove(strReturn.LastIndexOf(" "), 1);
        strScanList = strReturn.Split(',');
        //Query the scan list size
        strCommand = "ROUT:SCAN:SIZE?";
        Device_Send(strCommand);
        strReturn = ReadFromDev();
        s32SizeofScanlist = int.Parse(strReturn);
        if (s32SizeofScanlist == 0)
        {
            cmbxScanlist.Text = "";
        }
        else
        {
            for (int i = 0; i < s32SizeofScanlist; i++)
            {
                cmbxScanlist.Items.Add(strScanList[i]);
            }
        }
    }
}

```

8. Add the CheckedChanged event of the **radio button** controls.

1) The checked state of the VOLT:DC radio button has changed.

```

private void rbtnDCV_CheckedChanged(object sender, EventArgs e)
{
    if (rbtnDCV.Checked == true)
    {
        grpACFilter.Enabled = false;
        grpGatetime.Enabled = false;
        chkOcomp.Enabled = false;
    }
    else
    {
        grpACFilter.Enabled = true;
        grpGatetime.Enabled = true;
        chkOcomp.Enabled = true;
    }
}

```

2) The checked state of the VOLT:AC radio button has changed.

```

private void rbtnACV_CheckedChanged(object sender, EventArgs e)
{
    if (rbtnACV.Checked == true)
    {
        grpInterTime.Enabled = false;
        grpGatetime.Enabled = false;
        chkOcomp.Enabled = false;
        chkAZ.Enabled = false;
        chkInputimp.Enabled = false;
    }
    else
    {
        grpInterTime.Enabled = true;
        grpGatetime.Enabled = true;
    }
}

```

```

        chkOcomp.Enabled = true;
        chkAZ.Enabled = true;
        chkInputimp.Enabled = true;
    }
}

```

- 3) The checked state of the CURR:DC radio button has changed.

```

private void rbtnDCI_CheckedChanged(object sender, EventArgs e)
{
    if (rbtnDCI.Checked == true)
    {
        grpACFilter.Enabled = false;
        grpGatetime.Enabled = false;
        chkOcomp.Enabled = false;
        chkInputimp.Enabled = false;
    }
    else
    {
        grpACFilter.Enabled = true;
        grpGatetime.Enabled = true;
        chkOcomp.Enabled = true;
        chkInputimp.Enabled = true;
    }
}

```

- 4) The checked state of the CURR:AC radio button has changed.

```

private void rbtnACI_CheckedChanged(object sender, EventArgs e)
{
    if (rbtnACI.Checked == true)
    {
        grpInterTime.Enabled = false;
        grpGatetime.Enabled = false;
        chkOcomp.Enabled = false;
        chkAZ.Enabled = false;
        chkInputimp.Enabled = false;
    }
    else
    {
        grpInterTime.Enabled = true;
        grpGatetime.Enabled = true;
        chkOcomp.Enabled = true;
        chkAZ.Enabled = true;
        chkInputimp.Enabled = true;
    }
}

```

- 5) The checked state of the Frequency radio button has changed.

```

private void rbtnFrequency_CheckedChanged(object sender, EventArgs e)
{
    if (rbtnFrequency.Checked == true)
    {
        grpInterTime.Enabled = false;
        chkOcomp.Enabled = false;
        chkAZ.Enabled = false;
        chkInputimp.Enabled = false;
    }
    else
    {
        grpInterTime.Enabled = true;
        chkOcomp.Enabled = true;
        chkAZ.Enabled = true;
    }
}

```

```

        chkInputimp.Enabled = true;
    }
}
6) The checked state of the Period radio button has changed.
private void rbtnPeriod_CheckedChanged(object sender, EventArgs e)
{
    if (rbtnPeriod.Checked == true)
    {
        grpInterTime.Enabled = false;
        chkOcomp.Enabled = false;
        chkAZ.Enabled = false;
        chkInputimp.Enabled = false;
    }
    else
    {
        grpInterTime.Enabled = true;
        chkOcomp.Enabled = true;
        chkAZ.Enabled = true;
        chkInputimp.Enabled = true;
    }
}
7) The checked state of the Temperature radio button has changed.
private void rbtnTemp_CheckedChanged(object sender, EventArgs e)
{
    if (rbtnTemp.Checked == true)
    {
        grpRange.Enabled = false;
        grpACFilter.Enabled = false;
        chkInputimp.Enabled = false;
        grpGatetime.Enabled = false;
        if (cmbboxTemp.Text != "")
        {
            if (cmbboxTemp.Text.Substring(0, 2) == "TC")
            {
                chkOcomp.Enabled = false;
                chkAZ.Enabled = true;
            }
            else if (cmbboxTemp.Text.Substring(0, 2) == "TH")
            {
                chkOcomp.Enabled = false;
                chkAZ.Enabled = true;
            }
            else if (cmbboxTemp.Text.Substring(0, 2) == "RT" ||
cmbboxTemp.Text.Substring(0, 2) == "FR")
            {
                chkOcomp.Enabled = true;
                chkAZ.Enabled = false;
            }
            else
            {
            }
        }
    }
    else
    {
        grpRange.Enabled = true;
        grpACFilter.Enabled = true;
        chkInputimp.Enabled = true;
        grpGatetime.Enabled = true;
    }
}

```

```

        chkOcomp.Enabled = true;
        chkAZ.Enabled = true;
    }
}

```

- 8) The checked state of the Anysensor radio button has changed.

```
private void rbtnAnySensor_CheckedChanged(object sender, EventArgs e)
```

```

{
    if (rbtnAnySensor.Checked == true)
    {
        grpRange.Enabled = false;
        grpScale.Enabled = false;
        grpGatetime.Enabled = false;

        if (cmbxAnySensor.Text == "CURR")
        {
            grpInterTime.Enabled = true;
            chkAZ.Enabled = true;
            grpACFilter.Enabled = false;
            chkOcomp.Enabled = false;
            chkInputimp.Enabled = false;
        }
        else if (cmbxAnySensor.Text == "VOLT")
        {
            grpInterTime.Enabled = true;
            chkAZ.Enabled = true;
            chkInputimp.Enabled = true;
            grpACFilter.Enabled = false;
            chkOcomp.Enabled = false;
        }
        else if (cmbxAnySensor.Text == "FREQ")
        {
            grpACFilter.Enabled = true;
            grpInterTime.Enabled = false;
            chkInputimp.Enabled = false;
            chkAZ.Enabled = false;
            chkOcomp.Enabled = false;
        }
        else{ }
    }
    else
    {
        grpRange.Enabled = true;
        grpScale.Enabled = true;
        grpGatetime.Enabled = true;
        grpACFilter.Enabled = true;
        grpInterTime.Enabled = true;
        chkInputimp.Enabled = true;
        chkAZ.Enabled = true;
        chkOcomp.Enabled = true;
    }
}

```

9. Add the SelectedIndexChanged event of the **ComboBox** controls.

- 1) The SelectedIndex of cmbxTemp has changed.

```
private void cmbxTemp_SelectedIndexChanged(object sender, EventArgs e)
```

```

{
    if (rbtnTemp.Checked == true)
    {
        if (cmbxTemp.Text.Substring(0, 2) == "TC")

```

```

        {
            chkOcomp.Enabled = false;
            chkAZ.Enabled = true;
        }
        else if (cmbxTemp.Text.Substring(0, 2) == "TH")
        {
            chkOcomp.Enabled = false;
            chkAZ.Enabled = true;
        }
        else if (cmbxTemp.Text.Substring(0, 2) == "RT" || cmbxTemp.Text.Substring(0,
2) == "FR")
        {
            chkOcomp.Enabled = true;
            chkAZ.Enabled = false;
        }
        else
        { }
    }
    else
    {
        chkOcomp.Enabled = true;
        chkAZ.Enabled = true;
    }
}

```

- 2) The SelectedIndex of cmbxAnySensor has changed.

```

private void cmbxAnySensor_SelectedIndexChanged(object sender, EventArgs e)
{
    if (rbtnAnySensor.Checked == true)
    {
        grpRange.Enabled = false;
        grpScale.Enabled = false;
        grpGatetime.Enabled = false;

        if (cmbxAnySensor.Text == "CURR")
        {
            grpInterTime.Enabled = true;
            chkAZ.Enabled = true;
            grpACFilter.Enabled = false;
            chkOcomp.Enabled = false;
            chkInputimp.Enabled = false;
        }
        else if (cmbxAnySensor.Text == "VOLT")
        {
            grpInterTime.Enabled = true;
            chkAZ.Enabled = true;
            chkInputimp.Enabled = true;
            grpACFilter.Enabled = false;
            chkOcomp.Enabled = false;
        }
        else if (cmbxAnySensor.Text == "FREQ")
        {
            grpACFilter.Enabled = true;
            grpInterTime.Enabled = false;
            chkInputimp.Enabled = false;
            chkAZ.Enabled = false;
            chkOcomp.Enabled = false;
        }
        else { }
    }
}

```

```

}
else
{
    grpRange.Enabled = true;
    grpScale.Enabled = true;
    grpGatetime.Enabled = true;
    grpACFilter.Enabled = true;
    grpInterTime.Enabled = true;
    chkInputimp.Enabled = true;
    chkAZ.Enabled = true;
    chkOcomp.Enabled = true;
}
}
}

```

10. Running results.

- 1) Click the **Connect** button to search for the M300 series Data Acquisition/Switch System and connect it;
- 2) Enter a command into the **Command** textbox, for example, \*IDN?;
- 3) Click **Send** button to send the command;
- 4) Click **Read** button to read the return value.

The running results are as shown in the figure below.

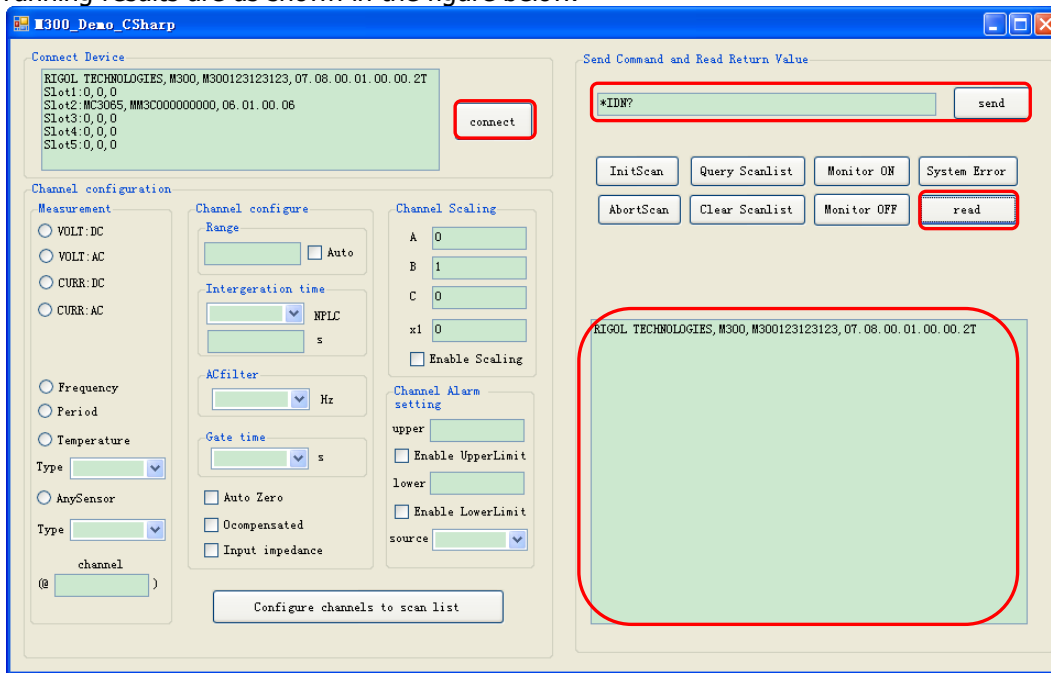

- 5) You can select a measurement function and configure the corresponding measurement parameters for the specified channels. You can also set the trigger count, click the **Configure channels to scanlist** button to make the configuration effective and add the specified channels into the scan list. The measurement parameters include the range, intergeration time, gate time, auto zero, input impedance, scaling parameters and alarm setting.

For example: select the temperature measurement function and set the sensor type to TC, T for channels 101 through 112; set the intergeration time to 2PLC; enable the auto zero function and configure the alarm upper limit to 50°C and set the alarm channel to alarm2. Click the **Configure channels to scanlist** button to send the above configurations to the instrument. Click the **Query Scanlist** button to query the configuration of the scan list. The running results are as shown in the figure on the next page.

**Note:**

[1] When you select a measurement function, the corresponding measurement parameter controls will be

enabled and the measurement parameter controls which does not correspond to the specified measurement function will be disabled.

- [2] For the integration time setting, if the NPLC combobox is empty, the value of the text control will be taken as the integration time.
- [3] The channel formats are as follows.
  - 101 represents channel 01 on the module in Slot1;
  - 101:103 represents channels 01 through 03 on the module in Slot1;
  - 101:103,301 represents channels 01 through 03 on the module in Slot1 and channel 01 on the module in Slot3.
- [4] You can also omit some measurement parameters. Clearing the text for the Text and ComBox controls can omit the corresponding parameters and disabling the checked state for the CheckBox control will omit the corresponding parameters.

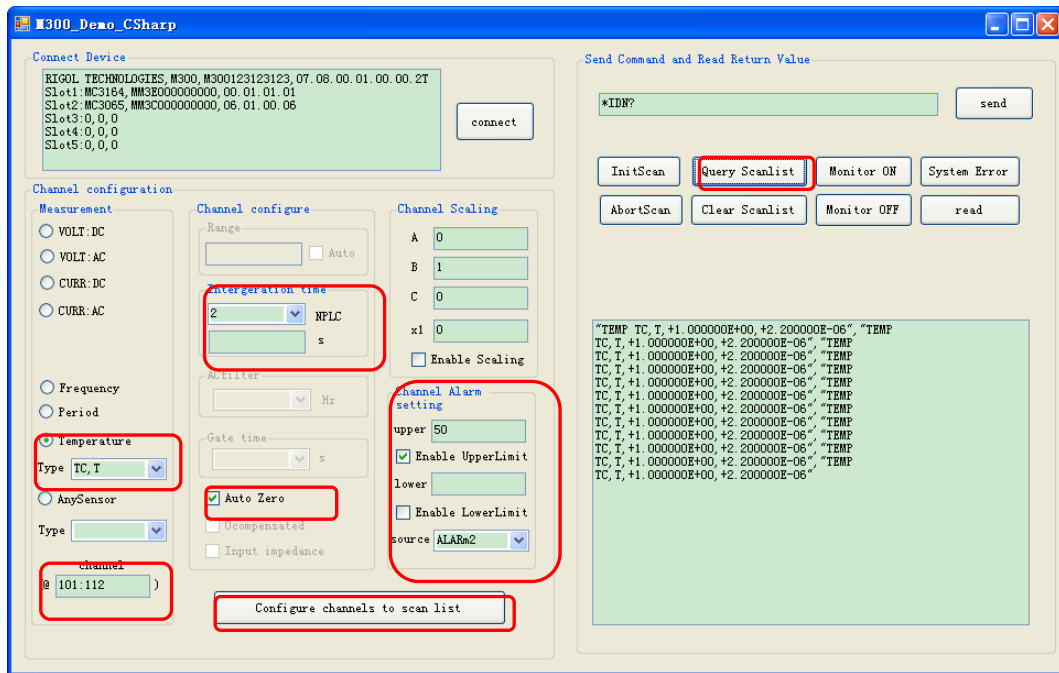

- 6) Click the **InitScan** button to place the instrument in the "wait-for-trigger" state.
- 7) Click the **Abort** button to abort the scan in progress.
- 8) Click the **Query Scanlist** button to query the configuration of the scan list.
- 9) Click the **Clear Scanlist** button to remove all the channels from the scan list.
- 10) Click the **Monitor ON** button to enable the single-channel monitor mode.
- 11) Click the **Monitor OFF** button to disable the monitor mode.
- 12) Click the **System Error** button to query a system error. Click the **read** button to read and clear the error.





## Chapter 5 Appendix

### Appendix A: Factory Settings

Parameter	Factory Setting
<b>Scan Configuration</b>	
Scan List	Empty
Reading Memory	Cleared
Max, Min, Average and SDEV	Cleared
Trigger Mode	Auto
Scan Interval	10 s (use the TRIGger:SOURce TIMer command)
Number of Scans	1
<b>Measurement Configuration</b>	
Function	DCV
Range	Auto
Integration Time	1 PLC
Input Impedance	10 M $\Omega$
Channel Delay	Auto
TOT Reading Mode	READ
TOT Trigger Mode	Rising
<b>Scaling Configuration</b>	
Scaling Configuration	OFF
A	0
B	1
C	0
x1	0
Unit	V
<b>Alarm Configuration</b>	
Alarm Mode	NONE
Alarm Channel	Alarm1
HI	0
LO	0
<b>Alarm Channel Configuration</b>	
Alarm Queue	Not cleared
Output Status	Cleared
Output Mode	Latch
Alarm Output	Low Level
<b>Channel Monitor</b>	
Monitor in Progress	Stop
<b>Module Control</b>	
MC3120/MC3132/MC3164	All channels off
MC3416	All channels off
MC3534	4 DIO ports: input

	4 TOT counts: 0 4 DAC: 0 VDC
MC3648	All channels off
<b>System-related</b>	
Date	No change
Time	No change
Language	No change
Sound	ON
DMM	No change
Screen Saver	OFF
Decimal Point	.
Separator	None
Power-on	Default
Power Key	OFF
Module Plug	No change
Brightness	8
Error Queue	Not cleared

**Note\***: the instrument is restored to its factory settings when the power is cycled (the power-on value is set to "Default", refer to the [SYSTem:UTIlity:CONFigure:POWEron](#) command) or sending the [\\*RST](#) command.

## Appendix B: Instrument Preset State

Parameter	Preset Setting
<b>Scan Configuration</b>	
Scan List	No change
Reading Memory	Cleared
Max, Min, Average and SDEV	Cleared
Trigger Mode	No change
Scan Interval	No change
Number of Scans	No change
<b>Measurement Configuration</b>	
Function	No change
Range	No change
Integration Time	No change
Input Impedance	No change
Channel Delay	No change
TOT Reading Mode	No change
TOT Trigger Mode	No change
<b>Scaling Configuration</b>	
Scaling Configuration	No change
A	No change
B	No change
C	No change
x1	No change
Unit	No change
<b>Alarm Configuration</b>	
Alarm Mode	No change
Alarm Channel	No change
HI	No change
LO	No change
<b>Alarm Channel Configuration</b>	
Alarm Queue	No change
Output Mode	No change
Output Status	Cleared
Alarm Output	No change
<b>Channel Monitor</b>	
Monitor in Progress	Stop
<b>Module Control</b>	
MC3120/MC3132/MC3164	All channels off
MC3416	All channels off
MC3534	4 DIO ports: input 4 TOT counts: 0 4 DAC: 0 VDC
MC3648	All channels off

<b>System Related</b>	
Date	No change
Time	No change
Language	No change
Sound	ON
DMM	No change
Screen Saver	OFF
Decimal Point	.
Separator	None
Power-on	Default
Power Key	OFF
Module Plug	No change
Brightness	8

**Note\***: Sending the [SYSTem:PRESet](#) command can restore the instrument to its preset settings.

## **Appendix C: Non-volatile Memory**

Information in the non-volatile memory is not lost when the power is turned off.

## **Appendix D: Volatile Memory**

Information in the volatile memory is lost when the power is turned off.

# Appendix E: Module Schematic Diagram

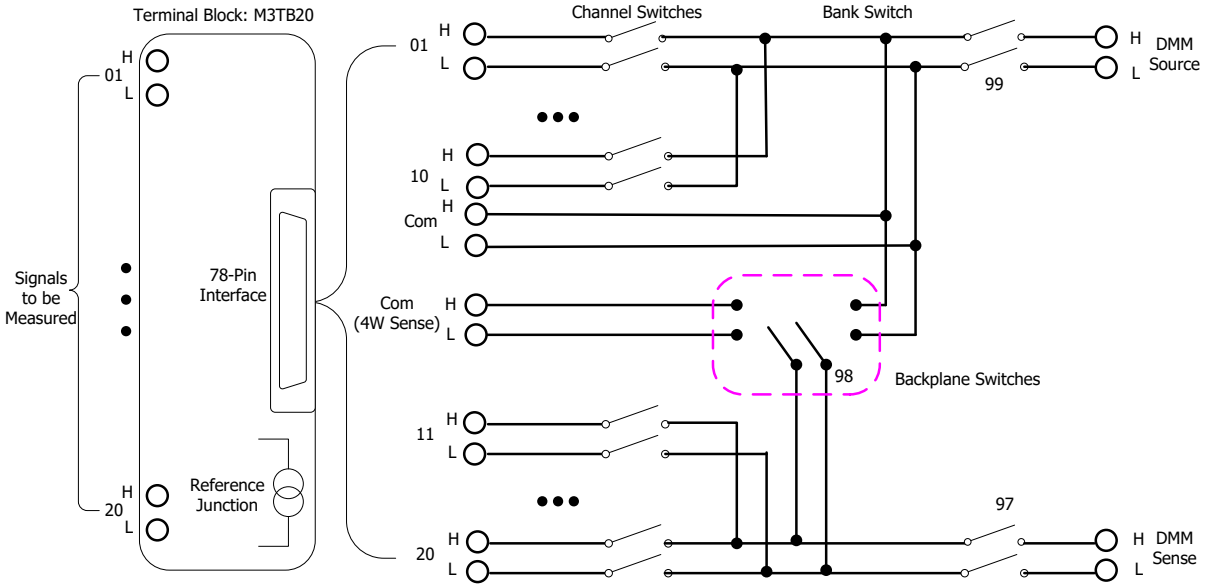

Figure 5-1 MC3120 Schematic Diagram

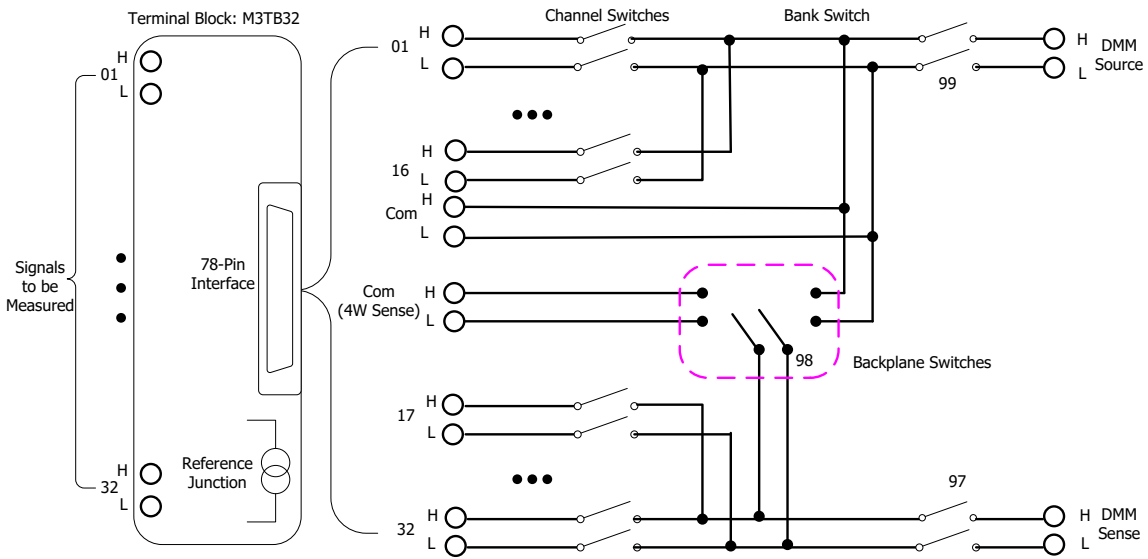

Figure 5-2 MC3132 Schematic Diagram

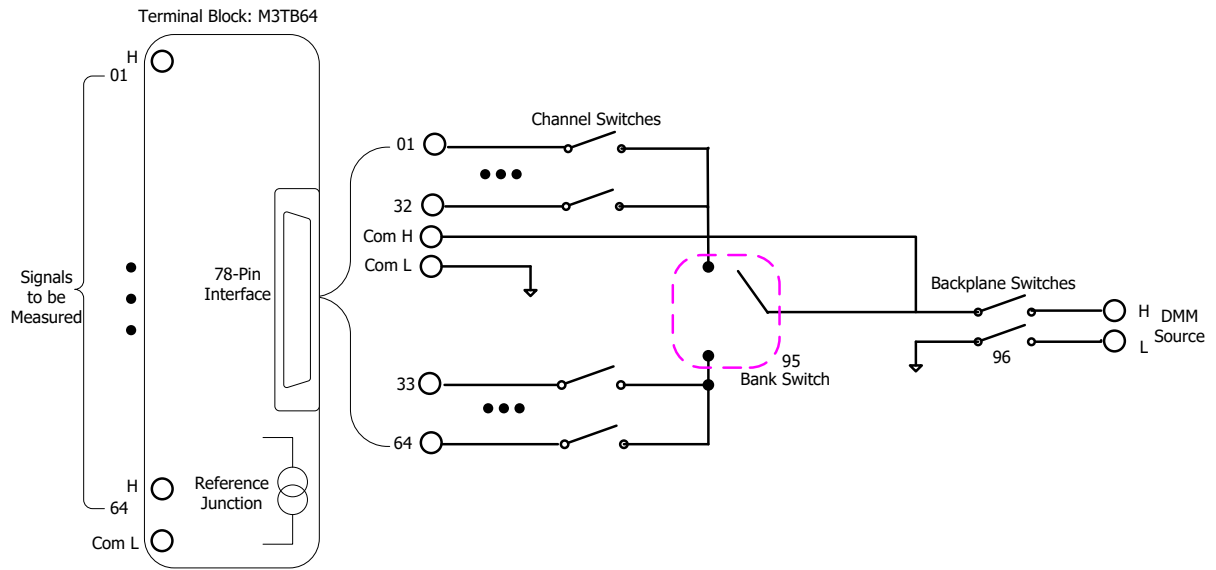

Figure 5-3 MC3164 Schematic Diagram

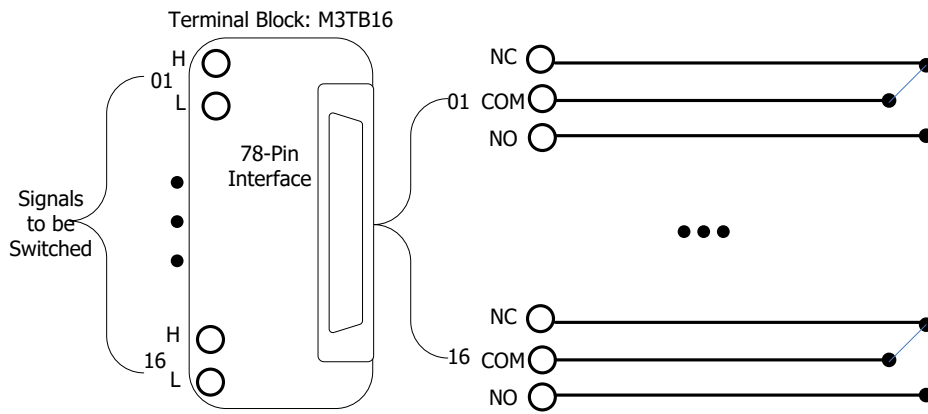

Figure 5-4 MC3416 Schematic Diagram

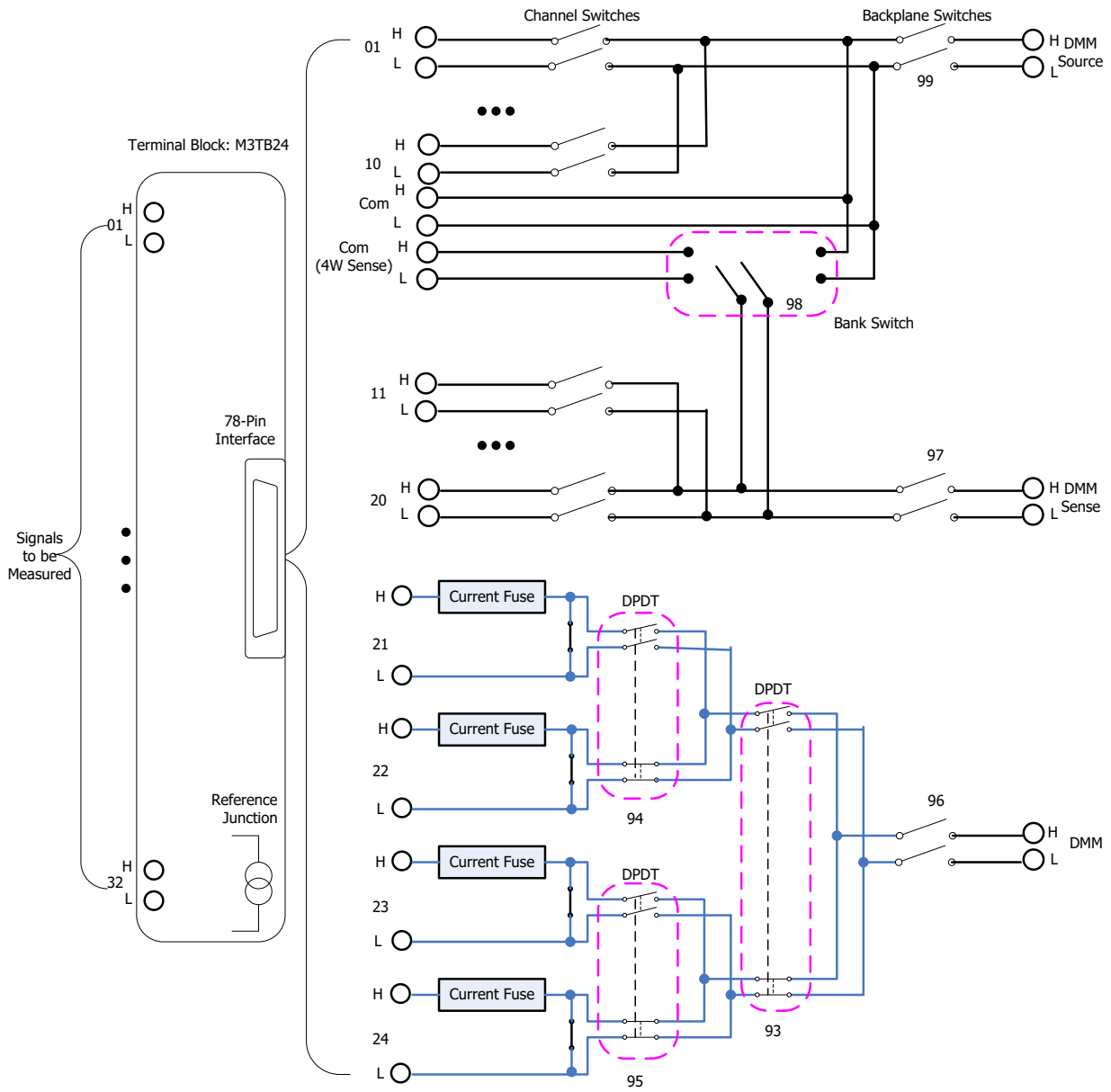

Figure 5-5 MC3324 Schematic Diagram



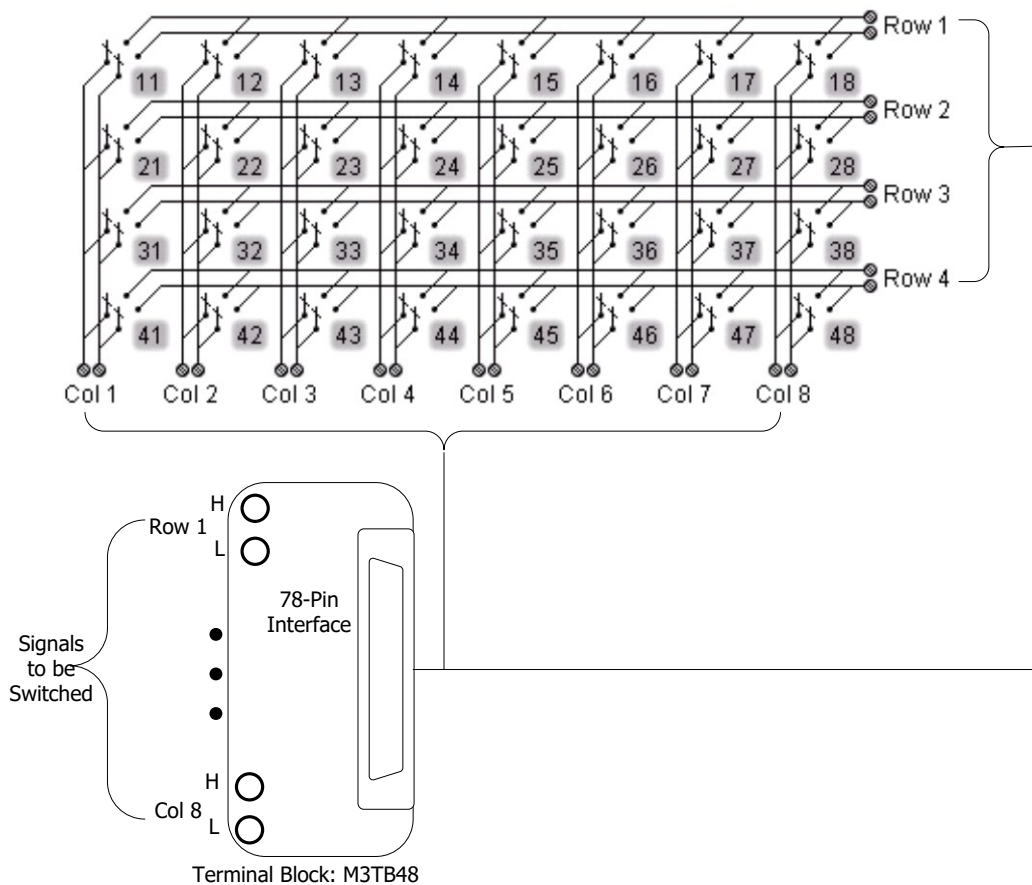

Figure 5-6 MC3648 Schematic Diagram

## Appendix F: Command List

- ◆ [ABORt](#)
- ◆ [CALCulate Command Subsystem](#)
  - [CALCulate:AVERage:AVERage?](#)
  - [CALCulate:AVERage:MAXimum?](#)
  - [CALCulate:AVERage:MINimum?](#)
  - [CALCulate:AVERage:PTPeak?](#)
  - [CALCulate:AVERage:SDEV?](#)
  - [CALCulate:AVERage:CLEar](#)
  - [CALCulate:AVERage:COUNt?](#)
  - [CALCulate:AVERage:MAXimum:TIME?](#)
  - [CALCulate:AVERage:MINimum:TIME?](#)
  - [CALCulate:COMPare:DATA](#)
  - [CALCulate:COMPare:MASK](#)
  - [CALCulate:COMPare:STATe](#)
  - [CALCulate:COMPare:TYPE](#)
  - [CALCulate:LIMit:LOWer](#)
  - [CALCulate:LIMit:UPPer](#)
  - [CALCulate:LIMit:LOWer:STATe](#)
  - [CALCulate:LIMit:UPPer:STATe](#)
  - [CALCulate:SCALE:SQUare](#)
  - [CALCulate:SCALE:GAIN](#)
  - [CALCulate:SCALE:OFFSet](#)
  - [CALCulate:SCALE:CONStant](#)
  - [CALCulate:SCALE:OFFSet:NULL](#)
  - [CALCulate:SCALE:STATe](#)
  - [CALCulate:SCALE:UNIT](#)
- ◆ [CONFigure Command Subsystem](#)
  - [CONFigure?](#)
  - [CONFigure:ANYSensor](#)
  - [CONFigure:COPY:CH:CH](#)
  - [CONFigure:COPY:CH:SLOT](#)
  - [CONFigure:COPY:SLOT:SLOT](#)
  - [CONFigure:CURRent:AC](#)
  - [CONFigure:CURRent\[:DC\]](#)
  - [CONFigure:DIGital:BYTE](#)
  - [CONFigure:DIGital:DWORd](#)
  - [CONFigure:DIGital:WORD](#)

- [CONFigure:FREQuency](#)
- [CONFigure:PERiod](#)
- [CONFigure:FRESistance](#)
- [CONFigure:RESistance](#)
- [CONFigure:TEMPerature](#)
- [CONFigure:TOTalize](#)
- [CONFigure:VOLTage:AC](#)
- [CONFigure:VOLTage\[:DC\]](#)
- ◆ [DATA Command Subsystem](#)
  - [DATA:LAST?](#)
  - [DATA:POINts?](#)
  - [DATA:POINts:EVENT:THReshold](#)
  - [DATA:REMOve?](#)
- ◆ [DIAGnostic Command Subsystem](#)
  - [DIAGnostic:DMM:CYCLes?](#)
  - [DIAGnostic:DMM:CYCLes:CLEar](#)
  - [DIAGnostic:PEEK:SLOT:DATA](#)
  - [DIAGnostic:POKE:SLOT:DATA](#)
  - [DIAGnostic:RELAy:CYCLes?](#)
  - [DIAGnostic:RELAy:CYCLes:CLEar](#)
- ◆ [DISPlay Command Subsystem](#)
  - [DISPlay](#)
  - [DISPlay:TEXT](#)
  - [DISPlay:TEXT:CLEar](#)
- ◆ [FETCh?](#)
- ◆ [FORMat Command Subsystem](#)
  - [FORMat:READing:ALARm](#)
  - [FORMat:READing:CHANnel](#)
  - [FORMat:READing:TIME](#)
  - [FORMat:READing:TIME:TYPE](#)
  - [FORMat:READing:UNIT](#)
- ◆ [IEEE-488.2 Common Commands](#)
  - [\\*CLS](#)
  - [\\*ESE](#)
  - [\\*ESR?](#)
  - [\\*IDN?](#)
  - [\\*OPC](#)
  - [\\*PSC](#)
  - [\\*RST](#)

[\\*SAV](#)

[\\*RCL](#)

[\\*SRE](#)

[\\*STB?](#)

[\\*TRG](#)

[\\*WAI](#)

- ◆ [INITiate](#)
- ◆ [INPut:IMPedance:AUTO](#)
- ◆ [INSTRument Command Subsystem](#)
  - [INSTRument:DMM](#)
  - [INSTRument:DMM:INSTalled?](#)
- ◆ [LXI Command Subsystem](#)
  - [LXI:IDENTify\[:STATE\]](#)
  - [LXI:RESet](#)
  - [LXI:REStart](#)
- ◆ [MEASure Command Subsystem](#)
  - [MEASure:ANYSensor?](#)
  - [MEASure:CURR:AC?](#)
  - [MEASure:CURR\[:DC\]?](#)
  - [MEASure:DIGital:BYTE?](#)
  - [MEASure:DIGital:DWORd?](#)
  - [MEASure:DIGital:WORD?](#)
  - [MEASure:FREQuency?](#)
  - [MEASure:PERiod?](#)
  - [MEASure:TEMPerature?](#)
  - [MEASure:TOTalize?](#)
  - [MEASure:VOLTage:AC?](#)
  - [MEASure:VOLTage\[:DC\]?](#)
- ◆ [MEMory Command Subsystem](#)
  - [MEMory:NSTates?](#)
  - [MEMory:SAVE:SYSTem](#)
  - [MEMory:NAME:SYSTem?](#)
  - [MEMory:RECall:SYSTem](#)
  - [MEMory:SAVE:CONFig](#)
  - [MEMory:NAME:CONFig?](#)
  - [MEMory:RECall:CONFig](#)
  - [MEMory:SAVE:MIRRor](#)
  - [MEMory:NAME:MIRRor?](#)
  - [MEMory:RECall:MIRRor](#)

- [MEMory:SAVE:DATA](#)
- [MEMory:NAME:DATA?](#)
- [MEMory:RECall:DATA](#)
- [MEMory:STATe:DELeTe](#)
- [MEMory:STATe:NAME](#)
- [MEMory:STATe:RECall](#)
- [MEMory:STATe:VALid?](#)
- ◆ [MMEMory Command Subsystem](#)
  - [MMEMory:EXPort?](#)
  - [MMEMory:FORMat:READIng:CSEParator](#)
  - [MMEMory:FORMat:READIng:RLIMit](#)
  - [MMEMory:IMPort:CATalog?](#)
  - [MMEMory:IMPort:CONFig?](#)
  - [MMEMory:LOG\[:ENABLE\]](#)
- ◆ [OUTPut Command Subsystem](#)
  - [OUTPut:ALARm<n>:CLEar](#)
  - [OUTPut:ALARm:CLEar:ALL](#)
  - [OUTPut:ALARm<n>:ENABLE?](#)
  - [OUTPut:ALARm\[<n>\]:MODE](#)
  - [OUTPut:ALARm\[<n>\]:SLOPe](#)
  - [OUTPut:ALARm<n>:SOURce](#)
- ◆ [R?](#)
- ◆ [READ?](#)
- ◆ [ROUTe Command Subsystem](#)
  - [ROUTe:CHANnel:ADVance:SOURce](#)
  - [ROUTe:CHANnel:ADVance:EDGE](#)
  - [ROUTe:CHANnel:DELay](#)
  - [ROUTe:CHANnel:DELay:AUTO](#)
  - [ROUTe:CHANnel:FWIRe](#)
  - [ROUTe:CLOSe](#)
  - [ROUTe:CLOSe:EXCLusive](#)
  - [ROUTe:DONE?](#)
  - [ROUTe:MONitor\[:CHAN\]](#)
  - [ROUTe:MONitor:DATA?](#)
  - [ROUTe:MONitor:DATA:FULL?](#)
  - [ROUTe:MONitor:STATe](#)
  - [ROUTe:OPEN](#)
  - [ROUTe:SCAN](#)
  - [ROUTe:SCAN:SIZE?](#)

◆ [SENSe Command Subsystem](#)

[\[SENSe:\]ANYSensor:FREQuency:RANGe:LOWer](#)  
[\[SENSe:\]ANYSensor:VOLTag:e:APERture](#)  
[\[SENSe:\]ANYSensor:VOLTag:e:NPLC](#)  
[\[SENSe:\]ANYSensor:CURRent:APERture](#)  
[\[SENSe:\]ANYSensor:CURRent:NPLC](#)  
[\[SENSe:\]ANYSensor:SEGMENT](#)  
[\[SENSe:\]ANYSensor:SEGMENT:CLear](#)  
[\[SENSe:\]ANYSensor:TYPE](#)  
[\[SENSe:\]CURRent:AC:BANDwidth](#)  
[\[SENSe:\]CURRent:AC:RANGe](#)  
[\[SENSe:\]CURRent\[:DC\]:RANGe](#)  
[\[SENSe:\]CURRent:AC:RANGe:AUTO](#)  
[\[SENSe:\]CURRent\[:DC\]:RANGe:AUTO](#)  
[\[SENSe:\]CURRent:AC:RESolution](#)  
[\[SENSe:\]CURRent\[:DC\]:APERture](#)  
[\[SENSe:\]CURRent\[:DC\]:NPLC](#)  
[\[SENSe:\]CURRent\[:DC\]:RESolution](#)  
[\[SENSe:\]DIGital:DATA\[:BYTE\]?](#)  
[\[SENSe:\]DIGital:DATA:WORD?](#)  
[\[SENSe:\]DIGital:DATA:DWORd?](#)  
[\[SENSe:\]DIGital:TYPE](#)  
[\[SENSe:\]DIGital:LEVel](#)  
[\[SENSe:\]DIGital:THReshold](#)  
[\[SENSe:\]FREQuency:APERture](#)  
[\[SENSe:\]PERiod:APERture](#)  
[\[SENSe:\]FREQuency:RANGe:LOWer](#)  
[\[SENSe:\]PERiod:RANGe:LOWer](#)  
[\[SENSe:\]FREQuency:VOLTag:e:RANGe](#)  
[\[SENSe:\]PERiod:VOLTag:e:RANGe](#)  
[\[SENSe:\]FREQuency:VOLTag:e:RANGe:AUTO](#)  
[\[SENSe:\]PERiod:VOLTag:e:RANGe:AUTO](#)  
[\[SENSe:\]FUNCTION](#)  
[\[SENSe:\]TEMPerature:APERture](#)  
[\[SENSe:\]TEMPerature:NPLC](#)  
[\[SENSe:\]TEMPerature:RJUNction?](#)  
[\[SENSe:\]TEMP:TRANsducer:FRTD:OCOMPensated](#)  
[\[SENSe:\]TEMP:TRANsducer:RTD:OCOMPensated](#)  
[\[SENSe:\]TEMPerature:TRANsducer:FRTD:RESistance\[:REFerence\]](#)

[\[SENSe:\]TEMPerature:TRANsducer:RTD:RESistance\[:REFerence\]](#)  
[\[SENSe:\]TEMPerature:TRANsducer:FRTD:TYPE](#)  
[\[SENSe:\]TEMPerature:TRANsducer:RTD:TYPE](#)  
[\[SENSe:\]TEMPerature:TRANsducer:TCouple:CHECK](#)  
[\[SENSe:\]TEMPerature:TRANsducer:TCouple:RJUNction](#)  
[\[SENSe:\]TEMPerature:TRANsducer:TCouple:RJUNction:TYPE](#)  
[\[SENSe:\]TEMPerature:TRANsducer:TCouple:TYPE](#)  
[\[SENSe:\]TEMPerature:TRANsducer:THERmistor:TYPE](#)  
[\[SENSe:\]TEMPerature:TRANsducer:TYPE](#)  
[\[SENSe:\]TOTalize:CLEar:IMMediate](#)  
[\[SENSe:\]TOTalize:DATA?](#)  
[\[SENSe:\]TOTalize:SLOPe](#)  
[\[SENSe:\]TOTalize:STARt\[:IMMediate\]](#)  
[\[SENSe:\]TOTalize:STARt:DEFault](#)  
[\[SENSe:\]TOTalize:STOP\[:IMMediate\]](#)  
[\[SENSe:\]TOTalize:STOP:DEFault](#)  
[\[SENSe:\]TOTalize:TYPE](#)  
[\[SENSe:\]TOTalize:THReshold](#)  
[\[SENSe:\]VOLTage:AC:RANGe](#)  
[\[SENSe:\]VOLTage\[:DC\]:RANGe](#)  
[\[SENSe:\]VOLTage:AC:RANGe:AUTO](#)  
[\[SENSe:\]VOLTage\[:DC\]:RANGe:AUTO](#)  
[\[SENSe:\]VOLTage:AC:BANDwidth](#)  
[\[SENSe:\]VOLTage:AC:RESolution](#)  
[\[SENSe:\]VOLTage\[:DC\]:APERture](#)  
[\[SENSe:\]VOLTage\[:DC\]:NPLC](#)  
[\[SENSe:\]VOLTage\[:DC\]:RESolution](#)  
[\[SENSe:\]ZERO:AUTO](#)

◆ [SOURce Command Subsystem](#)

[SOURce:DIgital:DATA\[:BYTE\]](#)  
[SOURce:DIgital:DATA:DWORD](#)  
[SOURce:DIgital:DATA:WORD](#)  
[SOURce:DIgital:STATe?](#)  
[SOURce:VOLTage](#)

◆ [STATus Command Subsystem](#)

[STATus:ALARm:CONDition?](#)  
[STATus:ALARm:ENABLE](#)  
[STATus:ALARm\[:EVENT\]?](#)  
[STATus:OPERation:CONDition?](#)

[STATus:OPERation:ENABLE](#)

[STATus:OPERation\[:EVENT\]?](#)

[STATus:PRESet](#)

[STATus:QUEStionable:CONDition?](#)

[STATus:QUEStionable:ENABLE](#)

[STATus:QUEStionable\[:EVENT\]?](#)

◆ [SYSTem Command Subsystem](#)

[SYSTem:ALARm?](#)

[SYSTem:ANALog:OUTPut:SWITCh](#)

[SYSTem:COMMunicate:GPIB:ADDRes](#)

[SYSTem:COMMunicate:LAN:AUTOip](#)

[SYSTem:COMMunicate:LAN:CONTRol?](#)

[SYSTem:COMMunicate:LAN:DHCP](#)

[SYSTem:COMMunicate:LAN:DNS](#)

[SYSTem:COMMunicate:LAN:GATEWay](#)

[SYSTem:COMMunicate:LAN:IPADdress](#)

[SYSTem:COMMunicate:LAN:MAC?](#)

[SYSTem:COMMunicate:LAN:MANUip](#)

[SYSTem:COMMunicate:LAN:TELNet:PROMpt](#)

[SYSTem:COMMunicate:LAN:TELNet:WMESsage](#)

[SYSTem:COMMunicate:LAN:SMASK](#)

[SYSTem:COMMunicate:LAN:UPDate](#)

[SYSTem:COMMunicate:RS232:BAUD](#)

[SYSTem:COMMunicate:RS232:FLOWcontrol](#)

[SYSTem:COMMunicate:RS232:PARItY](#)

[SYSTem:COMMunicate:RS232:PRINt:STATe](#)

[SYSTem:CPON](#)

[SYSTem:CTYPe:DEFine](#)

[SYSTem:CTYPe:DEFault](#)

[SYSTem:CTYPe?](#)

[SYSTem:DATE](#)

[SYSTem:EDITion?](#)

[SYSTem:ERRor?](#)

[SYSTem:IDN:USER:DEFine](#)

[SYSTem:IDN:DEFault](#)

[SYSTem:LFRequency?](#)

[SYSTem:LOCal](#)

[SYSTem:OPENTimes?](#)

[SYSTem:PRESet](#)



[SYSTem:REMOte](#)  
[SYSTem:RWLock](#)  
[SYSTem:SECurity\[:IMMediate\]](#)  
[SYSTem:SERIal?](#)  
[SYSTem:TIME](#)  
[SYSTem:TIME:SCAN?](#)  
[SYSTem:TYPE?](#)  
[SYSTem:UTIliTy:BEEPer:STATe](#)  
[SYSTem:UTIliTy:CARDOperation](#)  
[SYSTem:UTIliTy:CONFIgure:POWEron](#)  
[SYSTem:UTIliTy:DISPlay:BRIGht](#)  
[SYSTem:UTIliTy:FORMat:DECImal](#)  
[SYSTem:UTIliTy:FORMat:SEPARate](#)  
[SYSTem:UTIliTy:LANGUage](#)  
[SYSTem:UTIliTy:POWEr:SWITCh:STATe](#)  
[SYSTem:UTIliTy:SAVEr:STATe](#)  
[SYSTem:UTIliTy:SAVEr:TIME](#)  
[SYSTem:VERSion?](#)

◆ [TRIGger Command Subsystem](#)

[TRIGger:ABSolute](#)  
[TRIGger:COUNt](#)  
[TRIGger:EDGE](#)  
[TRIGger:SOURce](#)  
[TRIGger:TIMer](#)

◆ [UNIT Command Subsystem](#)

[UNIT:ANYSensor](#)  
[UNIT:TEMPerature](#)

## Appendix G: Warranty

**RIGOL** TECHNOLOGIES CO., LTD. (hereinafter referred to as **RIGOL**) warrants that the product will be free from defects in materials and workmanship within the warranty period. If a product proves defective within the warranty period, **RIGOL** guarantees free replacement or repair for the defective product.

To get repair service, please contact with your nearest **RIGOL** sales or service office.

There is no other warranty, expressed or implied, except such as is expressly set forth herein or other applicable warranty card. There is no implied warranty of merchantability or fitness for a particular purpose. Under no circumstances shall **RIGOL** be liable for any consequential, indirect, ensuing, or special damages for any breach of warranty in any case.