



RIGOL

DM858 Series

Digital Multimeter

Quick Guide

Nov. 2023

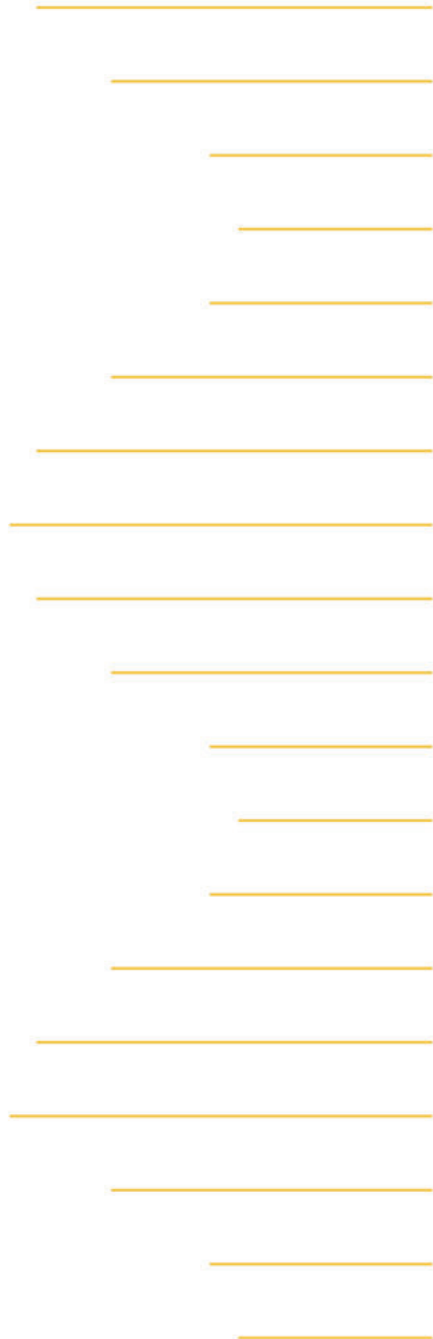

Guaranty and Declaration

Copyright

© 2023 RIGOL TECHNOLOGIES CO., LTD. All Rights Reserved.

Trademark Information

RIGOL® is the trademark of RIGOL TECHNOLOGIES CO., LTD.

Software Version

Software upgrade might change or add product features. Please acquire the latest software version from **RIGOL** website or contact **RIGOL** to upgrade the software.

Notices

- RIGOL products are covered by P.R.C. and foreign patents, issued and pending.
- RIGOL reserves the right to modify or change parts of or all the specifications and pricing policies at the company's sole decision.
- Information in this publication replaces all previously released materials.
- Information in this publication is subject to change without notice.
- RIGOL shall not be liable for either incidental or consequential losses in connection with the furnishing, use, or performance of this manual, as well as any information contained.
- Any part of this document is forbidden to be copied, photocopied, or rearranged without prior written approval of RIGOL.

Product Certification

RIGOL guarantees that this product conforms to the national and industrial standards in China as well as the ISO9001:2015 standard and the ISO14001:2015 standard. Other international standard conformance certifications are in progress.

Contact Us

If you have any problem or requirement when using our products or this manual, please contact RIGOL.

E-mail: service@rigol.com

Website: <http://www.rigol.com>

1 Safety Requirement

1.1 General Safety Summary

Please review the following safety precautions carefully before putting the instrument into operation so as to avoid any personal injury or damage to the instrument and any product connected to it. To prevent potential hazards, please follow the instructions specified in this manual to use the instrument properly.

- | | | | |
|---|--|----|--|
| 1 | Please exclusive power cord designed for the instrument and authorized for use within the destination country could be used. | 9 | Do not operate the instrument with suspected failures. |
| 2 | Ensure that the instrument is safely grounded. | 10 | Provide adequate ventilation. |
| 3 | Observe all terminal ratings. | 11 | Do not operate in wet conditions. |
| 4 | Use proper overvoltage protection. | 12 | Do not operate in an explosive atmosphere. |
| 5 | Do not operate without covers. | 13 | Keep instrument surfaces clean and dry. |
| 6 | Do not insert objects into the air outlet. | 14 | Prevent electrostatic impact. |
| 7 | Use the proper fuse. | 15 | Handle with caution. |
| 8 | Avoid circuit or wire exposure. | | |



WARNING

Equipment meeting Class A requirements may not offer adequate protection to broadcast services within residential environment.

1.2 Safety Notices and Symbols

Safety Notices in this Manual:



WARNING

Indicates a potentially hazardous situation or practice which, if not avoided, will result in serious injury or death.



CAUTION

Indicates a potentially hazardous situation or practice which, if not avoided, could result in damage to the product or loss of important data.

Safety Notices on the Product:

- **DANGER**

It calls attention to an operation, if not correctly performed, could result in injury or hazard immediately.

- **WARNING**

It calls attention to an operation, if not correctly performed, could result in potential injury or hazard.

- **CAUTION**

It calls attention to an operation, if not correctly performed, could result in damage to the product or other devices connected to the product.

Safety Symbols on the Product:

**Hazardous
Voltage**



Safety Warning



**Protective Earth
Terminal**



Chassis Ground



Test Ground

1.3 Input Terminal Protection Limits

Protection Limits are defined for the input terminals:

Main Input (HI and LO) Terminals

The HI and LO input terminals are used for voltage, resistance, capacitance, continuity, frequency (period), and diode test measurements. The following two Protection Limits are defined for these terminals:

1. HI to LO Protection Limit: 1000 VDC or 750 VAC, which is also the maximum voltage measurement. This limit can also be expressed as 1000 Vpk maximum.
2. LO to Ground Protection Limit. The LO input terminal can safely "float" a maximum of 500 Vpk relative to the ground.

The protection limit for HI terminal is a maximum of 1000 Vpk relative to the ground. Therefore, the sum of the "float" voltage and the measured voltage cannot exceed 1000 Vpk.

Sense (HI Sense and LO Sense) Terminal

HI Sense and LO Sense terminals are used only for four-wire resistance measurements. The following two Protection Limits are defined for these terminals:

1. HI Sense to LO Sense Protection Limit. HI Sense to LO Sense Protection Limit: 200 Vpk.

2. LO Sense to LO Protection Limit. LO Sense to LO Protection Limit: 2 Vpk.

Current Input (I) Terminal

The I and LO terminals are used for current measurements. The I terminal has a protection limit of 10 A(DM858)/3 A(DM858E) maximum current flowing through the terminal by the front-panel current input fuse.



CAUTION

The current input terminal will be at approximately the same voltage as the LO terminal unless the current input fuse is blown. To maintain protection, replace this fuse only with a fuse of the specified type and rating.

1.4 IEC Measurement Category II

To protect against the danger of electric shock, DM858/DM858E Digital Multimeter provides overvoltage protection for line-voltage mains connections meeting both of the following conditions:

1. The HI and LO input terminals are connected to the mains under Measurement Category II conditions, defined below.
2. The mains are limited to a maximum line voltage of 300 VAC.



WARNING

IEC Measurement Category II includes electrical devices connected to mains at an outlet on a branch circuit. Such devices include most small appliances, test equipment, and other devices that plug into a branch outlet or socket. DM858/DM858E may be used to make measurements with the HI and LO inputs connected to mains in such devices (up to 300 VAC), or to the branch outlet itself. However, DM858/DM858E may not be used with its HI and LO inputs connected to mains in permanently installed electrical devices such as the main circuit-breaker panel, sub-panel disconnect boxes, or permanently wired motors. Such devices and circuits are subject to overvoltages that may exceed the protection limits of the DM858/DM858E.



CAUTION

Voltages above 300 VAC may be measured only in circuits that are isolated from mains. However, transient overvoltages are also present on circuits that are isolated from mains. DM858/DM858E is designed to safely withstand occasional transient overvoltage up to 2500 Vpk. Do not use this equipment to measure circuits where transient overvoltage could exceed this level.

1.5 Ventilation Requirement

This instrument uses a fan to force cooling. Please make sure that the air inlet and outlet areas are free from obstructions and have free air. When using the instrument

in a bench-top or rack setting, provide at least 10 cm clearance beside, above and behind the instrument for adequate ventilation.

**CAUTION**

Inadequate ventilation may cause an increase of temperature in the instrument, which would cause damage to the instrument. So please keep the instrument well ventilated and inspect the air outlet and the fan regularly.

1.6 Working Environment

Temperature

Operating: 0°C to +50°C

Non-operating: -20°C to +70°C

Humidity

≤80% RH, 40°C, without condensation

**WARNING**

To avoid short circuit inside the instrument or electric shock, never operate the instrument in a humid environment.

Altitude

Below 3 km

Protection Level Against Electric Shock

ESD ±8kV

Installation (Overvoltage) Category

This product is powered by mains conforming to installation (overvoltage) category II.

**WARNING**

Ensure that no overvoltage (such as that caused by a bolt of lightning) can reach the product. Otherwise, the operator might be exposed to the danger of an electric shock.

Installation (Overvoltage) Category Definitions

Installation (overvoltage) category I refers to signal level which is applicable to equipment measurement terminals connected to the source circuit. Among these terminals, precautions are done to limit the transient voltage to a low level.

Installation (overvoltage) category II refers to the local power distribution level which is applicable to equipment connected to the AC line (AC power).

Pollution Degree

Pollution Degree 2

Pollution Degree Definition

- **Pollution Degree 1:** No pollution or only dry, nonconductive pollution occurs. The pollution has no effect. For example, a clean room or air-conditioned office environment.
- **Pollution Degree 2:** Normally only nonconductive pollution occurs. Temporary conductivity caused by condensation is to be expected. For example, indoor environment.
- **Pollution Degree 3:** Conductive pollution or dry nonconductive pollution that becomes conductive due to condensation occurs. For example, sheltered outdoor environment.
- **Pollution Degree 4:** The pollution generates persistent conductivity caused by conductive dust, rain, or snow. For example, outdoor areas.

Safety Class

Class 2

1.7 Care and Cleaning

Care

Do not store or leave the instrument where it may be exposed to direct sunlight for long periods of time.

Cleaning

Clean the instrument regularly according to its operating conditions.

1. Disconnect the instrument from all power sources.
2. Clean the external surfaces of the instrument with a soft cloth dampened with mild detergent or water. Avoid having any water or other objects into the chassis via the heat dissipation hole. When cleaning the LCD, take care to avoid scarifying it.

CAUTION

To avoid damage to the instrument, do not expose it to caustic liquids.

WARNING

To avoid short-circuit resulting from moisture or personal injuries, ensure that the instrument is completely dry before connecting it to the power supply.

1.8 Environmental Considerations

The following symbol indicates that this product complies with the WEEE Directive 2002/96/EC.



The equipment may contain substances that could be harmful to the environment or human health. To avoid the release of such substances into the environment and avoid harm to human health, we recommend you to recycle this product appropriately to ensure that most materials are reused or recycled properly. Please contact your local authorities for disposal or recycling information.

You can click on the following link <https://int.rigol.com/services/services/declaration> to download the latest version of the RoHS&WEEE certification file.

2 Document Overview

This manual gives you a quick overview of the front and rear panel, user interface as well as basic operation methods of DM858 series digital multimeter.



TIP

For the latest version of this manual, download it from RIGOL official website (<http://www.rigol.com>).

Publication Number

QGC11100-1110

Software Version

Software upgrade might change or add product features. Please acquire the latest version of the manual from RIGOL website or contact RIGOL to upgrade the software.

Format Conventions in this Manual

1. Key

The front panel key is denoted by the menu key icon. For example,  indicates the "Trig" key.

2. Menu

The menu item is denoted by the format of "Menu Name (Bold) + Character Shading" in the manual. For example, **Measure** indicates the "Measure" menu item. You can click or tap **Measure** to access the "Measure" menu.

3. Operation Procedures

The next step of the operation is denoted by ">" in the manual. For example,  >

Storage indicates first clicking or tapping  and then clicking or tapping **Storage**.

4. Connector

The front/rear panel connector is denoted by "Brackets + Connector Name (Bold)", for example, **[EXT TRIG]**.

Content Conventions in this Manual

DM858 series digital multimeter includes DM858 and DM858E models. The table below shows the main differences between the two models. Their operation methods are the same. Unless otherwise specified, this manual takes DM858 as an example to illustrate the basic operation methods of DM858 series.

Specifications for Different Models		
	DM858	DM858E
DCV Accuracy (1 year)	0.030%	0.060%
Max. Reading Rate	125 readings/s	80 readings/s
No. of Points in Data Logging Memory	500,000 data points	20,000 data points
Current Measurement Range	100 μ A to 10 A	100 μ A to 3 A
Capacitance Measurement Range	1 nF to 10 mF	1 nF to 1 mF

3 General Inspection

1. Inspect the packaging

If the packaging has been damaged, do not dispose the damaged packaging or cushioning materials until the shipment has been checked for completeness and has passed both electrical and mechanical tests.

The consigner or carrier shall be liable for the damage to the instrument resulting from shipment. RIGOL would not be responsible for free maintenance/rework or replacement of the instrument.

2. Inspect the instrument

In case of any mechanical damage, missing parts, or failure in passing the electrical and mechanical tests, contact your RIGOL sales representative.

3. Check the accessories

Please check the accessories according to the packing lists. If the accessories are damaged or incomplete, please contact your RIGOL sales representative.

Recommended Calibration Interval

RIGOL suggests that the instrument should be calibrated every 12 months.

4 Product Overview

4.1 Appearance and Dimensions

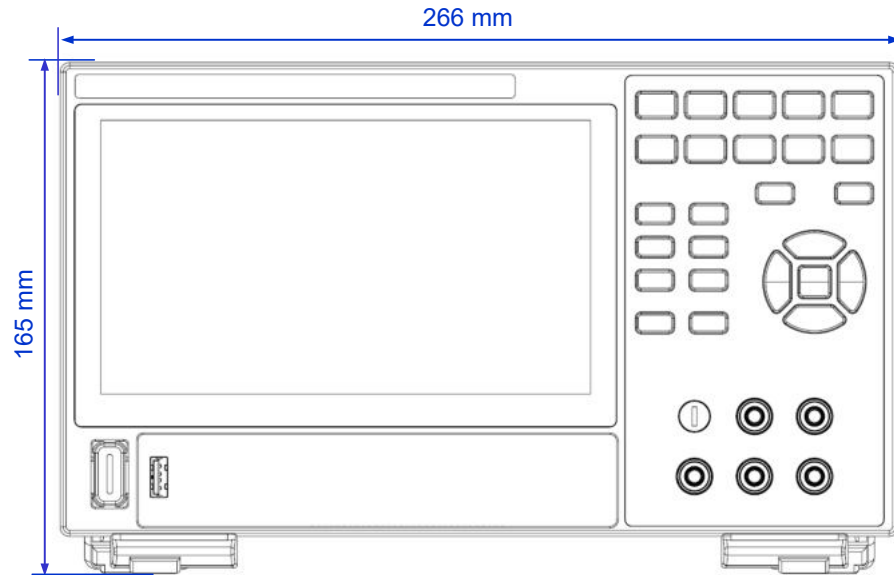

Figure 4.1 Front View

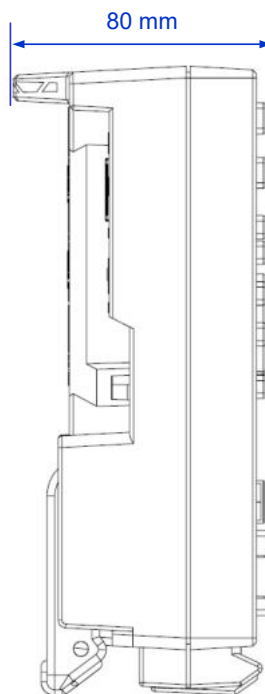

Figure 4.2 Side View

4.2 Front Panel Overview

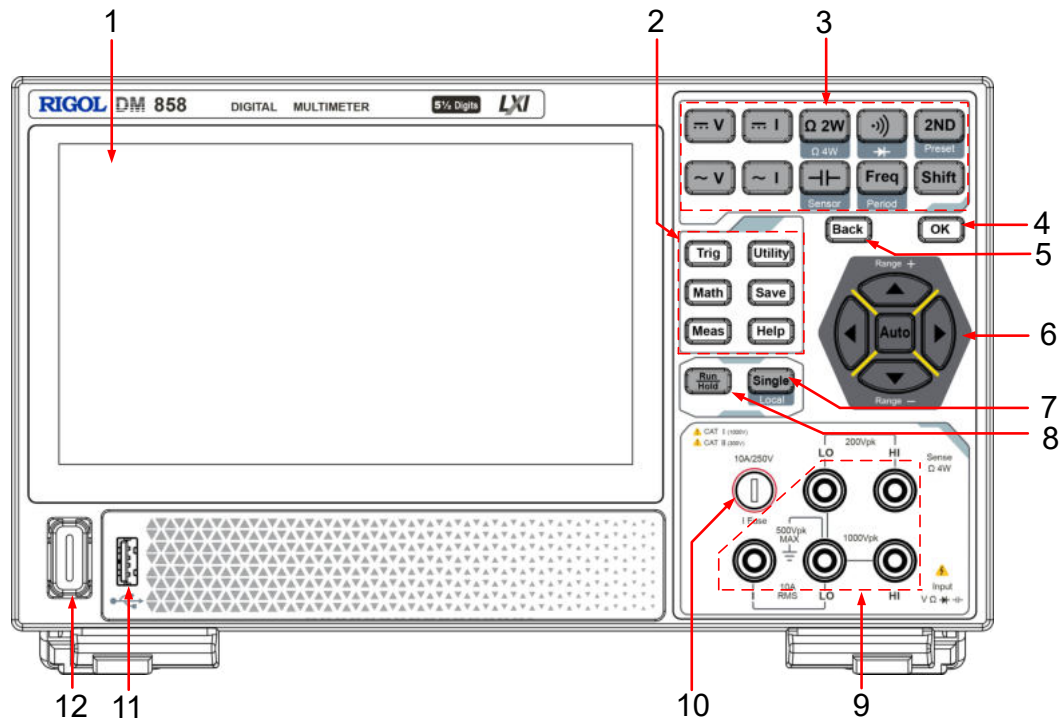





Figure 4.3 DM858 Front Panel

1	7-inch Capacitive Touch Screen	7	Single Trigger/Local Control Key
2	Auxiliary Function Keys	8	Auto Trigger/Reading Hold Key
3	Measurement Function Keys	9	Signal Input Terminals
4	Confirmation Key	10	Current Input Fuse
5	Back Key	11	USB HOST Interface
6	Rang Selection/Arrow Keys	12	Power Key

NOTE

Some measurement function keys are printed with words or icons below them, indicating that the key has a certain function. You can press and release , and then press the specified function key to use the function. For example, you can press and release , and then press  to enable the 4-wire resistance measurement function.

4.3 Rear Panel Overview

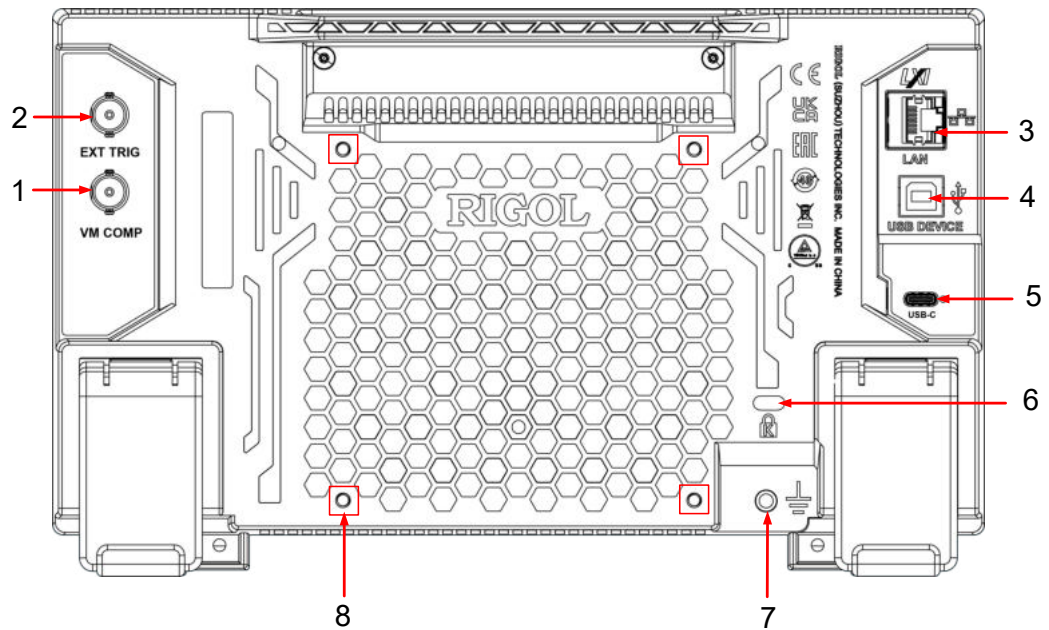

Figure 4.4 Rear Panel

- 1 VM COMP Output Interface
- 2 External Trigger Input Interface
- 3 LAN Interface
- 4 USB DEVICE Interface
- 5 USB Type-C Power Interface
- 6 Security Lock Hole
- 7 Ground Terminal
- 8 Mounting Screw Holes (VESA 100×100)

4.4 User Interface Overview



Figure 4.5 User Interface (Single Display)



Figure 4.6 User Interface (Dual Display)

1 Main Measurement Result

10 "Single" Function Key

2	Main Measurement Item	11	Notification Area
3	Main Measurement Range Selection Key	12	Shortcut Keys
4	Trigger Information Label	13	Function Navigation Icon
5	Measurement Speed Selection key	14	Main-Secondary Measurement Item Switchover Key
6	"Relative" Function Key	15	Secondary (2ND) Measurement Range
7	"Shift" Label	16	Secondary (2ND) Measurement Result
8	"2ND" Label	17	Secondary (2ND) Measurement Item
9	"Run/Hold" Function Key		

5 To Prepare for Use

5.1 To Adjust the Supporting Legs

Adjust the supporting legs properly to use them as stands to tilt the multimeter upwards for stable placement of the multimeter as well as better operation and observation. You can also fold the supporting legs when the instrument is not in use for easier storage or shipment, as shown in the figure below.

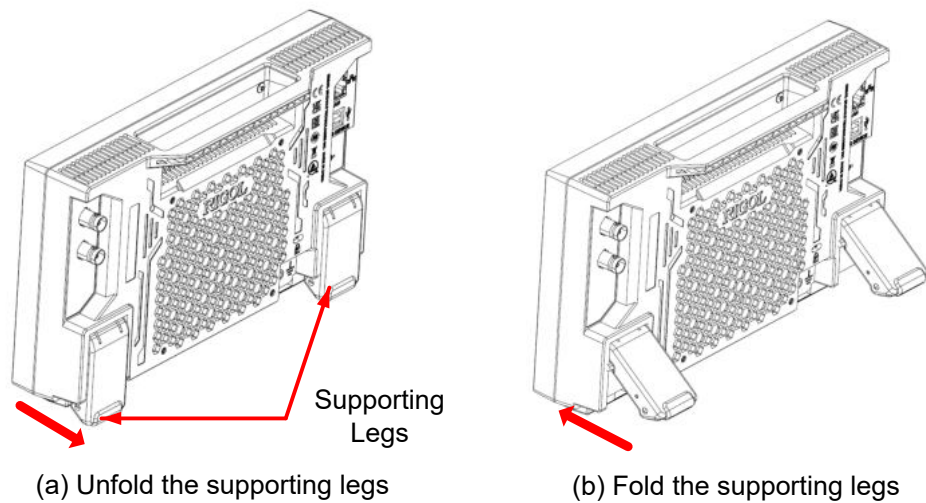
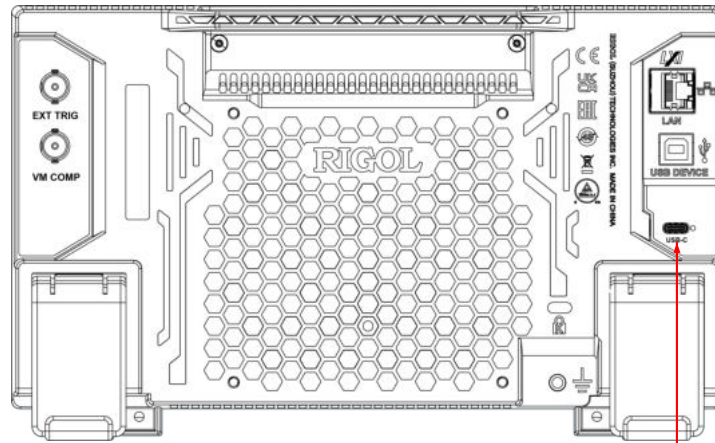

Figure 5.1 Adjusting the Supporting Legs

5.2 To Connect to Power

The power requirements of the multimeter are DC, 12 V, 3 A. Please use the power adaptor provided in the accessories to connect the multimeter to the AC power source (100 V to 240 V, 50 Hz to 60 Hz), as shown in the figure below.



Power Cord Connector

Figure 5.2 To Connect to Power

Table 5.1 Power Adaptor Specifications

Item	Description
Input	100 V to 240 V, 50 Hz to 60 Hz, 1.6 A Max
Output	DC, 12 V, 3 A, 36 W

**CAUTION**

The power adaptor provided in accessories can only be used to power RIGOL instruments. Do not use it for mobile phone and other devices.





**WARNING**

To avoid electric shock, ensure that the instrument is correctly grounded.

5.3 Turn-on Checkout

After the instrument is connected to the power source, press the power key  at the lower-left corner of the front panel to power on the instrument. During the start-up process, the instrument performs a series of self-tests. After the self-test, the splash screen is displayed.

- **Reboot:** Click or tap  > **Reboot**. Then a prompt message "Are you sure to reboot?" is displayed. Click or tap **OK** to restart the instrument.
- **Shutdown:**

- Click or tap  > **Shutdown**. Then a prompt message "Are you sure to shutdown?" is displayed. Click or tap **OK** to shut down the instrument.
- Press  and a prompt message "Are you sure to shutdown?" is displayed. Click or tap **OK** to shut down the instrument.
- Press  twice to shut down the instrument.
- Press  for three seconds to shut down the instrument.

**TIP**

You can also click or tap  > **System** > **Settings** and set the "Power Status" to "ON". The instrument powers on once connected to power.

5.4 To Set the System Language

This product supports multiple languages. You can click or tap  > **System** > **Settings** > **Language** to select the system language.

6 Touch Screen Gestures

The instrument's capacitive touch screen makes operation and configuration easy and flexible. It features great convenience, high flexibility, and great sensitivity. The actions supported by the touch screen controls include dragging and tapping.

6.1 Drag

Use one finger to select the object, and then drag the object to a destination place, as shown in *Figure 6.1*. You can also drag the window controls to change the window position (e.g. numeric keypad).

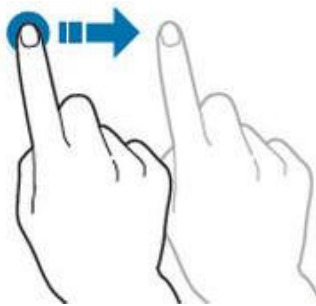

Figure 6.1 Drag Gesture

6.2 Tap

Use one finger to tap the symbol or characters on the screen slightly, as shown in *Figure 6.2*. With the Tap gesture, you can perform the following operations:

- Tap the menu displayed on the screen to operate on the menu.
- Tap the function navigation icon at the lower-left corner of the touch screen to enable the function navigation.
- Tap the displayed numeric keypad to set the parameters.
- Tap the virtual keypad to set the filename.
- Tap the close button at the upper-right corner of the message box to close the prompt window.
- Tap other windows on the touch screen and operate on the windows.



Figure 6.2 Tap Gesture

7 Measurement Connections

This multimeter provides multiple measurement functions. After selecting the desired measurement function, connect the signal (device) under test to the multimeter following the methods as shown below. Do not discretionarily switch the measurement function during measurements as it may cause damage to the multimeter. For example, when the test leads are connected to the related current terminals, AC voltage measurement should not be taken.

DCV Measurement

Connect the test leads to the circuit under test as shown below. Connect the red test lead to HI terminal and the black one to LO terminal.

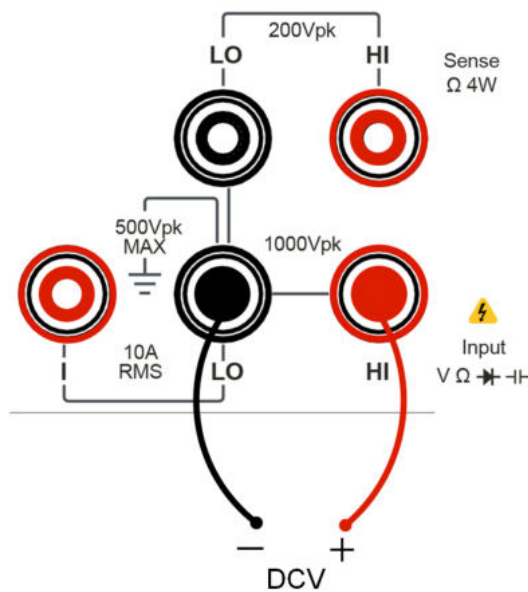

ACV Measurement

Connect the test leads to the circuit under test as shown below. Connect the red test lead to HI terminal and the black one to LO terminal.

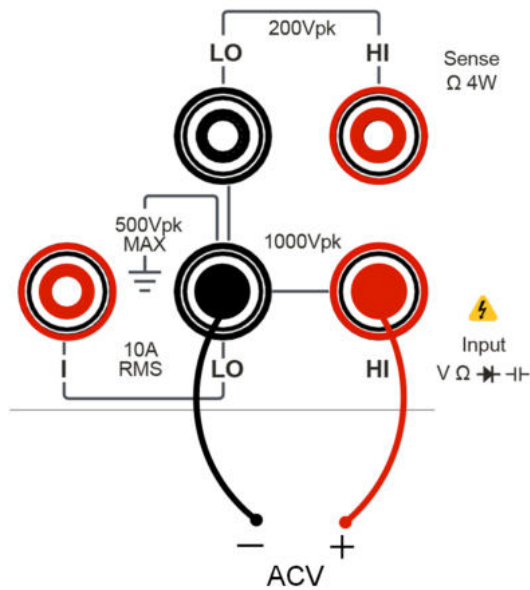

DCI Measurement

Connect the test leads to the circuit under test as shown below. Connect the red test lead to HI terminal and the black one to LO terminal.

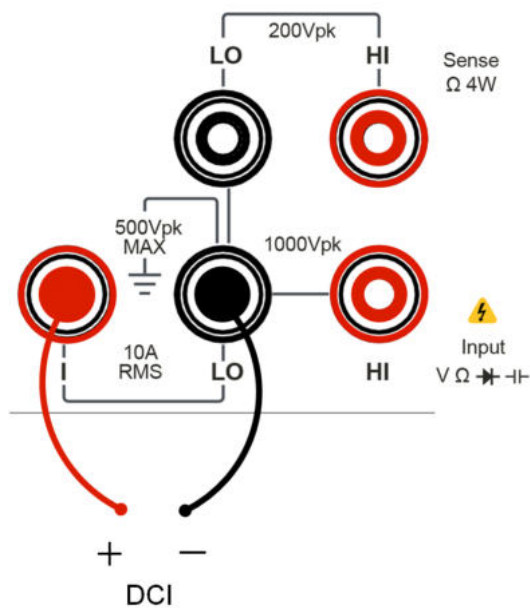

ACI Measurement

Connect the test leads to the circuit under test as shown below. Connect the red test lead to HI terminal and the black one to LO terminal.

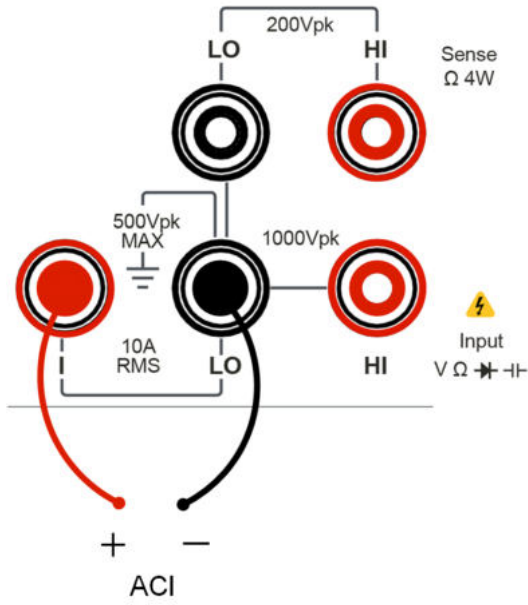

2-Wire Resistance Measurement

Connect the test leads to the circuit under test as shown below. Connect the red test lead to HI terminal and the black one to LO terminal.

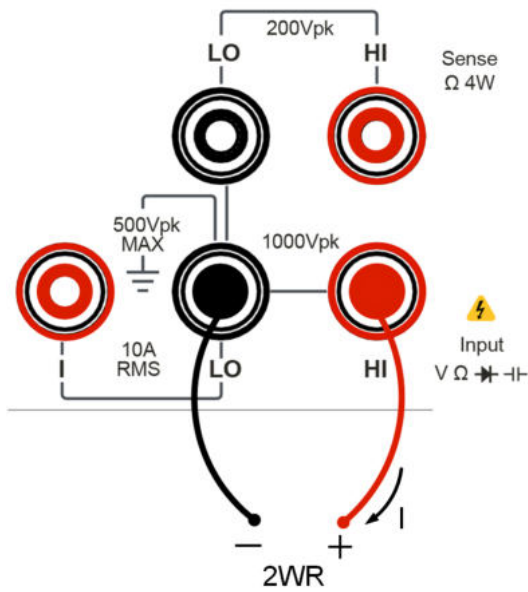

4-Wire Resistance Measurement

Connect the test leads to the circuit under test as shown below. Connect the red test lead to HI terminal and the black one to LO terminal.

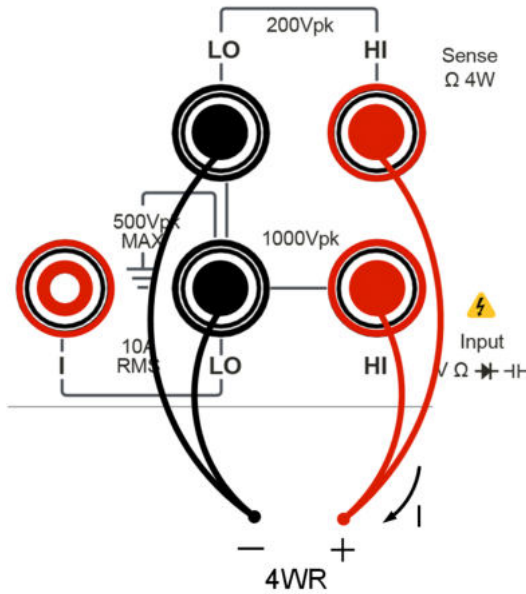

Capacitance Measurement

Connect the test leads to the circuit under test as shown below. Connect the red test lead to HI terminal and the black one to LO terminal.

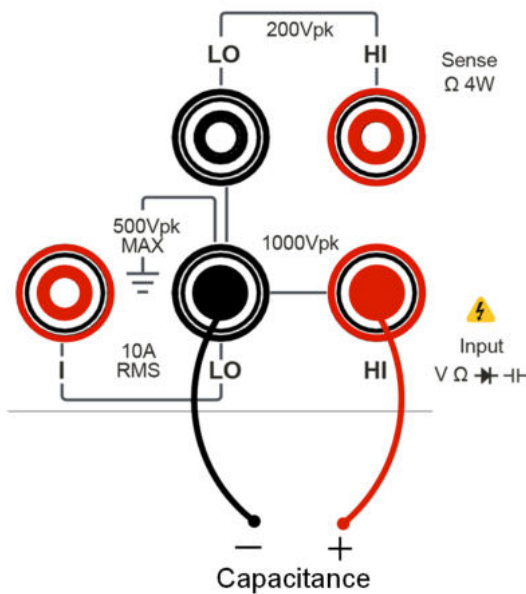

Continuity Measurement

Connect the test leads to the circuit under test as shown below. Connect the red test lead to HI terminal and the black one to LO terminal.

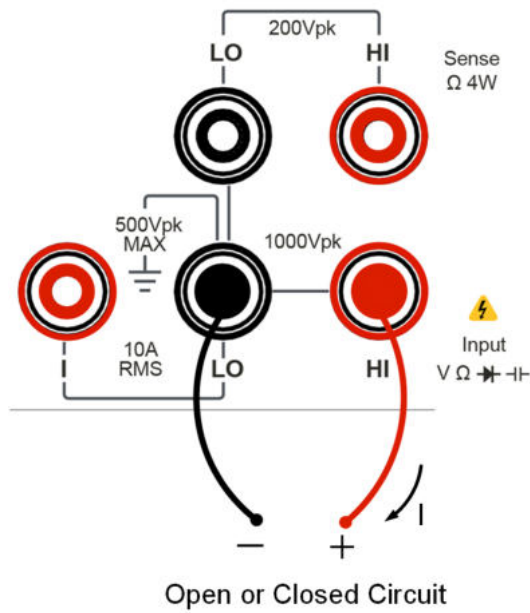

Diode Measurement

Connect the test leads to the circuit under test as shown below. Connect the red test lead to HI terminal and the black one to LO terminal.

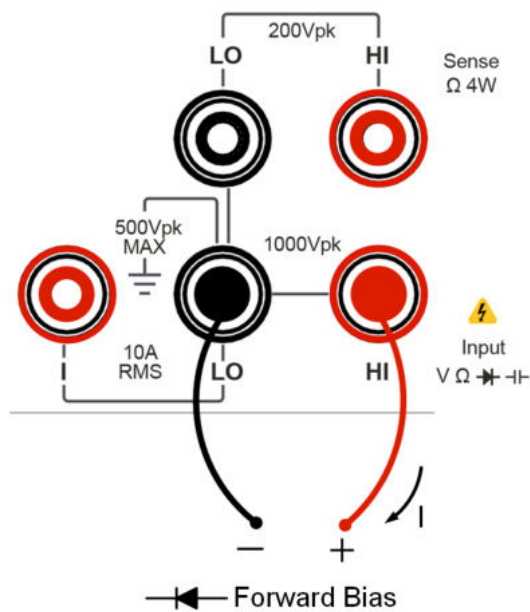

Frequency/Period Measurement

Connect the test leads to the circuit under test as shown below. Connect the red test lead to HI terminal and the black one to LO terminal.

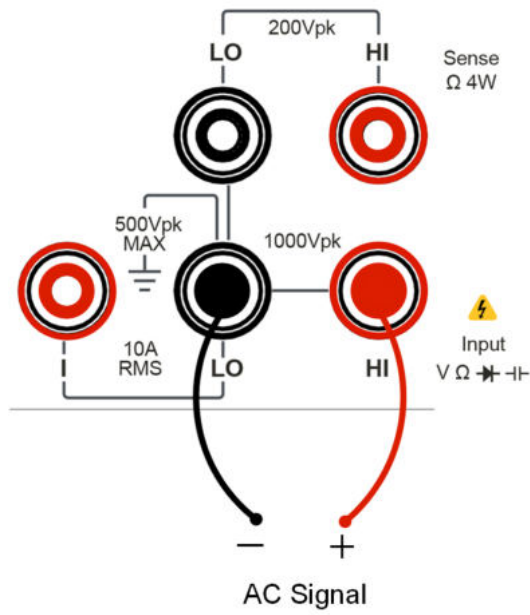

Sensor Measurement

Method 1: applicable to DCV, 2WR, FREQ, TC, 2W-Therm, and 2W-RTD sensors.

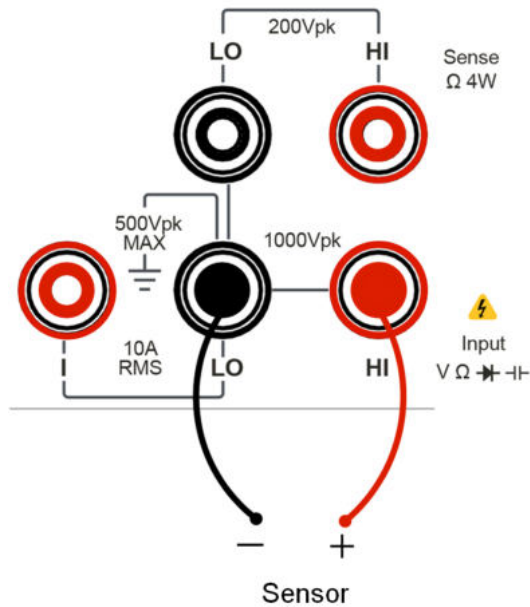

Method 2: applicable to DCI sensor.

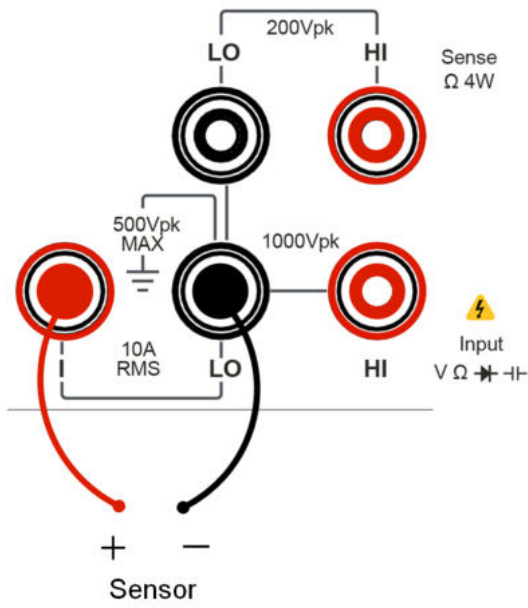

Method 3: applicable to 4WR, 4W-Therm, and 4W-RTD sensors.

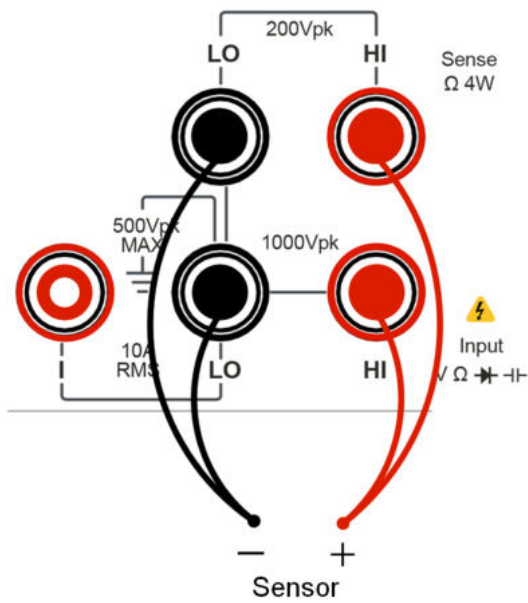

8 To Use the Security Lock

If necessary, you can lock the instrument to a fixed location by using a standard laptop security lock (please purchase it by yourself), as shown in the figure below.

The method is as follows: align the lock with the lock hole and plug it into the lock hole vertically, turn the key clockwise to lock the instrument, and then pull the key out.

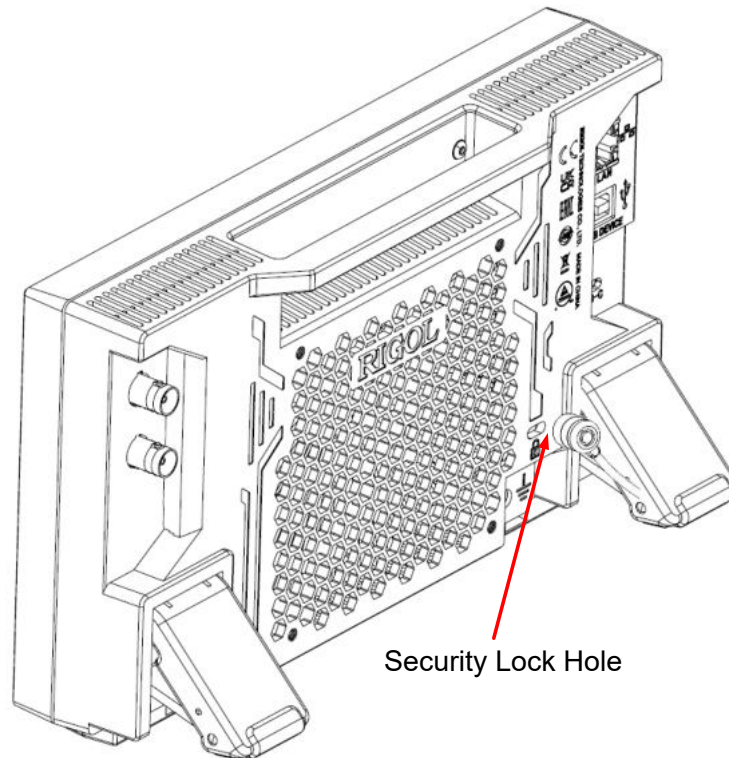

Figure 8.1 To Use the Security Lock



CAUTION

Please do not insert other objects into the security lock hole to avoid damaging the instrument.

9 To Replace Current Input Fuse

The instrument is equipped with a current input fuse on the front panel. The fuse provides a protection limit of 10 A (DM858)/3 A (DM858E) maximum current input. When the input current exceeds 13.5 A (DM858)/4 A (DM858E), the fuse is blown. To replace the fuse, follow the steps below:



I Fuse

1. Power off the multimeter and remove the power cord.
2. Use a slotted (flat head) screwdriver to turn the fuse holder in the direction as shown in the figure below and remove it from the instrument.
3. Replace this fuse with a fuse of the specified rating.
4. Re-insert the fuse holder into the instrument.

Model	Current Input Fuse Specification
DM858	AC 250 V F10 A
DM858E	AC 250 V F3.15 A



CAUTION

To maintain protection, replace this fuse only with a fuse of the specified type and rating.

10 To Use the Built-in Help System

The built-in help file provides information about the functions and menu

introductions of the instrument. Click or tap  > **Help** to enter the help system.

In the help system, you can get its help information by clicking on or tapping the link for the specified chapter.

11 Remote Control

The following ways of remote control are supported:

- **User-defined Programming**

Users can program and control the instrument by using the SCPI (Standard Commands for Programmable Instruments) commands. For details about the SCPI commands and programming, refer to *Programming Guide* of this product series.

- **PC Software**

You can use the PC software to send SCPI commands to control the instrument remotely. RIGOL Ultra Sigma is recommended. You can download the software from RIGOL official website (<http://www.rigol.com>).

Operation Procedures:

- Set up communication between the instrument and PC.
- Run Ultra Sigma and search for the instrument resource.
- Open the remote command control panel to send commands.

- **Web Control**

This instrument supports Web Control. Connect the instrument to the network, then input the IP address of the instrument into the address bar of the browser of your computer. The web control interface is displayed. Click Web Control to enter the web control page. Then you can view the display of the real-time interface of the instrument. Through the Web Control method, you can migrate the device control to the control terminals (e.g. PC, Mobile, iPad, and other smart terminals) to realize remote control of the instrument. You have to log in before using the Web Control to modify network settings. When you first log in to the Web Control, the user name is "admin" and password is "rigol".

This instrument can be connected to the PC via the USB and LAN interface to set up communication and realize remote control through the PC.

CAUTION

Before connecting the communication cable, please turn off the instrument to avoid causing damage to the communication interfaces.



12 More Product Information

Click or tap  > **System** > **About** to obtain the information of the instrument, such as the model, serial number, and software version number.

For more information about the instrument, refer to the relevant manuals by logging in to the official website of RIGOL (<http://www.rigol.com>) to download them.

- *DM858 Series User Guide* introduces the functions of the instrument and the operation methods, remote control methods, possible failures and solutions in using the instrument, specifications, and order information.
- *DM858 Series Programming Guide* provides detailed descriptions of SCPI commands and programming examples of the instrument.
- *DM858 Series Data Sheet* provides the key features and technical specifications of the instrument.

HEADQUARTER

RIGOL TECHNOLOGIES CO., LTD.
No.8 Keling Road, New District, Suzhou,
JiangSu, P.R.China
Tel: +86-400620002
Email: info@rigol.com

EUROPE

RIGOL TECHNOLOGIES EU GmbH
Carl-Benz-Str.11
82205 Gilching
Germany
Tel: +49(0)8105-27292-0
Email: info-europe@rigol.com

NORTH AMERICA

RIGOL TECHNOLOGIES, USA INC.
10220 SW Nimbus Ave.
Suite K-7
Portland, OR 97223
Tel: +1-877-4-**RIGOL**-1
Fax: +1-877-4-**RIGOL**-1
Email: info@rigol.com

JAPAN

RIGOL JAPAN CO., LTD.
5F,3-45-6,Minamiotsuka,
Toshima-Ku,
Tokyo,170-0005,Japan
Tel: +81-3-6262-8932
Fax: +81-3-6262-8933
Email: info-japan@rigol.com

RIGOL® is the trademark of **RIGOL TECHNOLOGIES CO., LTD.** Product information in this document is subject to update without notice. For the latest information about **RIGOL**'s products, applications and services, please contact local **RIGOL** channel partners or access **RIGOL** official website: www.rigol.com