



**RIGOL**

# HDO1000 Series

Digital Oscilloscope

User Guide

Sep.2022



## **Guaranty and Declaration**

### **Copyright**

© 2022 RIGOL TECHNOLOGIES CO., LTD. All Rights Reserved.

### **Trademark Information**

RIGOL® is the trademark of RIGOL TECHNOLOGIES CO., LTD.

### **Notices**

- RIGOL products are covered by P.R.C. and foreign patents, issued and pending.
- RIGOL reserves the right to modify or change parts of or all the specifications and pricing policies at the company's sole decision.
- Information in this publication replaces all previously released materials.
- Information in this publication is subject to change without notice.
- RIGOL shall not be liable for either incidental or consequential losses in connection with the furnishing, use, or performance of this manual, as well as any information contained.
- Any part of this document is forbidden to be copied, photocopied, or rearranged without prior written approval of RIGOL.

### **Product Certification**

RIGOL guarantees that this product conforms to the national and industrial standards in China as well as the ISO9001:2015 standard and the ISO14001:2015 standard. Other international standard conformance certifications are in progress.

### **Contact Us**

If you have any problem or requirement when using our products or this manual, please contact RIGOL.

E-mail: [service@rigol.com](mailto:service@rigol.com)

Website: <http://www.rigol.com>

Section	Description	Page
	List of Figures.....	VII
	List of Tables.....	XII
1	Safety Requirement.....	1
1.1	General Safety Summary.....	1
1.2	Safety Notices and Symbols.....	3
1.3	Measurement Category.....	3
1.4	Ventilation Requirement.....	4
1.5	Working Environment.....	4
1.6	Care and Cleaning.....	6
1.7	Environmental Considerations.....	6
2	Product Features.....	8
3	Document Overview.....	9
4	Quick Start.....	11
4.1	General Inspection.....	11
4.2	Appearance and Dimensions.....	11
4.3	To Prepare for Use.....	12
4.3.1	Tilting the Oscilloscope for Easier Viewing.....	12
4.3.2	Connecting to Power.....	13
4.3.3	Turn-on Checkout.....	13
4.3.4	Replacing the Fuse.....	14
4.3.5	Setting the System Language.....	15
4.3.6	Connecting Probes.....	15
4.3.7	Function Inspection.....	15
4.3.8	Probe Compensation.....	17
4.4	Product Overview.....	17
4.4.1	Front Panel Overview.....	18
4.4.2	Rear Panel Overview.....	24
4.4.3	User Interface Overview.....	26
4.5	Touch Screen Gestures.....	28
4.5.1	Tap.....	28
4.5.2	Pinch&Stretch.....	29
4.5.3	Drag.....	29
4.6	Parameter Setting Method.....	30

4.7	Using the Security Lock.....	36
4.8	Accessing the Built-in Help System.....	36
4.9	Viewing the Option Information and Installation.....	37
5	Vertical System.....	39
5.1	To Enable or Disable the Analog Channel.....	39
5.2	To Adjust the Vertical Scale.....	41
5.3	To Adjust the Vertical Offset.....	42
5.4	To Specify Channel Coupling.....	43
5.5	To Specify Bandwidth Limit.....	43
5.6	To Specify Input Impedance.....	44
5.7	To Invert a Waveform.....	44
5.8	To Set Probe.....	45
5.9	To Specify the Amplitude Unit.....	48
5.10	To Adjust Bias.....	48
5.11	To Specify the Skew.....	48
5.12	To Turn the Channel Label Display On/Off.....	49
6	Horizontal System.....	50
6.1	To Adjust the Horizontal Time Base.....	50
6.2	To Adjust the Horizontal Position.....	51
6.3	Zoom Mode (Delayed Sweep).....	52
7	Acquisition System.....	55
7.1	Acquisition Mode.....	55
7.2	Sampling Mode.....	57
7.3	Sample Rate.....	58
7.4	Memory Depth.....	59
7.5	Horizontal Expansion Reference.....	61
7.6	XY Mode.....	61
8	Triggering the Oscilloscope.....	64
8.1	Trigger Source.....	64
8.2	Trigger Level.....	65
8.3	Trigger Mode.....	66
8.4	Trigger Coupling.....	67
8.5	Trigger Holdoff.....	68
8.6	Noise Rejection.....	68
8.7	Trigger Type.....	69
8.7.1	Edge Trigger.....	69
8.7.2	Pulse Width Trigger.....	70

8.7.3	Slope Trigger.....	73
8.7.4	Video Trigger.....	76
8.7.5	Pattern Trigger.....	78
8.7.6	Duration Trigger.....	81
8.7.7	Timeout Trigger.....	84
8.7.8	Runt Trigger.....	86
8.7.9	Window Trigger.....	88
8.7.10	Delay Trigger.....	90
8.7.11	Setup/Hold Trigger.....	93
8.7.12	Nth Edge Trigger.....	95
8.7.13	RS232 Trigger.....	97
8.7.14	I2C Trigger.....	100
8.7.15	SPI Trigger.....	104
8.7.16	CAN Trigger.....	106
8.7.17	LIN Trigger.....	110
8.8	Trigger Output Connector.....	113
9	Math Operation.....	114
9.1	Arithmetic Operation.....	115
9.2	Function Operation.....	118
9.3	FFT Operation.....	121
9.4	Logic Operation.....	126
9.5	Digital Filter.....	130
10	Measurements.....	134
10.1	Measurement Parameter.....	134
10.1.1	Time Parameters.....	135
10.1.2	Count Values.....	136
10.1.3	Delay and Phase Parameters.....	138
10.1.4	Voltage Parameters.....	139
10.1.5	Other Parameters.....	141
10.2	Select the Measurement Item.....	141
10.3	Measurement Settings.....	144
10.4	Remove the Measurement Results.....	147
10.5	Auto Measurement.....	147
10.6	Cursor Measurements.....	148
10.6.1	Manual Mode.....	150
10.6.2	Track Mode.....	152
10.6.3	XY Mode.....	155

11	Digital Voltmeter (DVM) and Frequency Counter.....	158
11.1	Digital Voltmeter (DVM).....	158
11.1.1	Measurement Settings.....	158
11.1.2	Remove the Measurement.....	160
11.2	Frequency Counter.....	160
11.2.1	Measurement Settings.....	161
11.2.2	Reset Statistics.....	162
11.2.3	Remove the Measurement.....	162
12	Reference Waveform.....	163
12.1	To Enable Ref Function.....	163
12.2	To Set the Reference Waveform.....	163
12.3	To Set the Ref Waveform Display.....	164
12.4	Export and Import Operation.....	165
13	Pass/Fail Test.....	167
13.1	To Enable or Disable the Pass/Fail Test Function.....	167
13.2	To Select the Source.....	168
13.3	To Create a Mask.....	168
13.4	To Set the Output Form of the Test Results.....	168
13.5	To Start or Stop the Pass/Fail Test Operation.....	169
13.6	Display the Statistics of the Test Results.....	170
14	Protocol Decoding.....	172
14.1	Parallel Decoding.....	172
14.1.1	Clock Setting (CLK).....	173
14.1.2	Bus Setting.....	174
14.1.3	Display-related Settings.....	175
14.1.4	Event Table.....	175
14.2	RS232 Decoding.....	176
14.2.1	Source Setting.....	178
14.2.2	To Set Data Package.....	178
14.2.3	Display-related Settings.....	179
14.2.4	Event Table.....	180
14.3	I2C Decoding.....	180
14.3.1	Source Setting.....	181
14.3.2	Display-related Settings.....	182
14.3.3	Event Table.....	182
14.4	SPI Decoding.....	184
14.4.1	To Set the Source.....	185

14.4.2	To Set Mode and Data.....	185
14.4.3	Display-related Settings.....	186
14.4.4	Event Table.....	187
14.5	LIN Decoding.....	188
14.5.1	Signal Configuration.....	188
14.5.2	Display-related Settings.....	189
14.5.3	Event Table.....	189
14.6	CAN Decoding (Optional).....	191
14.6.1	Signal Configuration.....	191
14.6.2	Display-related Settings.....	192
14.6.3	Event Table.....	193
15	Multi-pane Windowing.....	195
16	Waveform Recording and Playing.....	197
16.1	Common Settings.....	197
16.2	Record Options.....	198
16.3	Play Options.....	199
17	Search and Navigation.....	202
17.1	Search.....	202
17.2	Navigation.....	204
18	Display Control.....	207
18.1	Display Type.....	207
18.2	Persistence Time.....	208
18.3	Waveform Intensity.....	208
18.4	To Set the Screen Grid.....	208
18.5	Display Settings.....	209
18.6	Show Scale.....	209
18.7	Color Grade.....	209
18.8	Waveform Freeze.....	209
19	Store and Load.....	211
19.1	To Enter the Storage Menu.....	211
19.2	To Save a File.....	211
19.2.1	Save Image.....	211
19.2.2	Save Wave.....	213
19.2.3	Save Setup.....	215
19.2.4	Binary Data Format (.bin).....	216
19.3	Load a File.....	219
19.4	System Upgrade.....	220

---

19.5	Disk Management.....	221
19.6	Factory Settings.....	223
20	System Utility Function Setting.....	234
20.1	I/O Setting.....	234
20.2	Basic Settings.....	236
20.3	About this Oscilloscope.....	238
20.4	Other Settings.....	239
20.5	Auto Config.....	239
20.6	SelfCal.....	240
20.7	Option List.....	241
20.8	Quick Action Settings.....	241
20.9	Self-check.....	243
21	Remote Control.....	246
21.1	Remote Control via USB.....	247
21.2	Remote Control via LAN.....	247
21.3	Remote Control via GPIB.....	248
22	Troubleshooting.....	250
23	Appendix.....	252
23.1	Appendix A: Options and Accessories.....	252
23.2	Appendix B: Warranty.....	252



# List of Figures

Figure 4.1 Front View .....	11
Figure 4.2 Side View .....	12
Figure 4.3 Flipping in/out Tabs .....	12
Figure 4.4 Connecting to Power .....	13
Figure 4.5 Replacing the Fuse .....	14
Figure 4.6 Connecting the Passive Probe .....	15
Figure 4.7 Using the Compensation Signal .....	16
Figure 4.8 Square Waveform Signal .....	16
Figure 4.9 Probe Compensation .....	17
Figure 4.10 Front Panel .....	18
Figure 4.11 Rear Panel .....	24
Figure 4.12 User Interface .....	26
Figure 4.13 Tap Gesture .....	29
Figure 4.14 Pinch&Stretch Gesture .....	29
Figure 4.15 Drag Gesture .....	30
Figure 4.16 English Input Interface .....	31
Figure 4.17 Chinese Input Interface .....	32
Figure 4.18 String Keypad .....	34
Figure 4.19 Numeric Keypad .....	35
Figure 4.20 To Use the Security Lock .....	36
Figure 5.1 Vertical Menu .....	39
Figure 5.2 Waveform Invert On/Off .....	45
Figure 5.3 Probe Setting Menu .....	46
Figure 5.4 Zero Offset .....	49
Figure 6.1 Horizontal Menu .....	50
Figure 6.2 Zoom Mode .....	53
Figure 7.1 Horizontal Menu .....	55

---

Figure 7.2 Display Modes .....	57
Figure 7.3 Memory Depth .....	60
Figure 7.4 XY Menu .....	62
Figure 7.5 Measurement Schematic Diagram of Phase Deviation .....	63
Figure 8.1 Schematic Diagram of the Acquisition Memory .....	66
Figure 8.2 Trigger Holdoff .....	68
Figure 8.3 Edge Trigger Setting Menu .....	69
Figure 8.4 Positive/Negative Pulse Width .....	71
Figure 8.5 Pulse Width Trigger Setting Menu .....	71
Figure 8.6 Positive Slope Time/Negative Slope Time .....	73
Figure 8.7 Slope Trigger Setting Menu .....	74
Figure 8.8 Video Trigger Setting Menu .....	76
Figure 8.9 Pattern Trigger .....	79
Figure 8.10 Pattern Trigger Setting Menu .....	79
Figure 8.11 Duration Trigger .....	81
Figure 8.12 Duration Trigger Setting Menu .....	82
Figure 8.13 Timeout Trigger .....	84
Figure 8.14 Timeout Trigger Menu .....	84
Figure 8.15 Runt Trigger .....	86
Figure 8.16 Runt Trigger Setting Menu .....	86
Figure 8.17 Window Trigger Setting Menu .....	88
Figure 8.18 Delay Trigger .....	90
Figure 8.19 Delay Trigger Setting Menu .....	90
Figure 8.20 Setup/Hold Trigger .....	93
Figure 8.21 Setup/Hold Trigger Setting Menu .....	93
Figure 8.22 Nth Edge Trigger .....	96
Figure 8.23 Nth Edge Trigger Setting Menu .....	96
Figure 8.24 Schematic Diagram of RS232 Protocol .....	98
Figure 8.25 RS232 Trigger Setting Menu .....	98

---

Figure 8.26 Schematic Diagram of I2C Protocol .....	100
Figure 8.27 I2C Trigger Setting Menu .....	101
Figure 8.28 Bin Format Setting .....	102
Figure 8.29 Hex Format Setting .....	103
Figure 8.30 Sequential Chart of SPI Bus .....	104
Figure 8.31 SPI Trigger Setting Menu .....	104
Figure 8.32 Data Frame Format of the CAN Bus .....	107
Figure 8.33 CAN Trigger Setting Menu .....	107
Figure 8.34 Sample Position .....	108
Figure 8.35 Data Frame Format of the LIN Bus .....	110
Figure 8.36 LIN Trigger Setting Menu .....	110
Figure 8.37 Sample Position .....	111
Figure 9.1 Math Menu .....	114
Figure 9.2 Waveform Display Window of the Operation Results .....	115
Figure 9.3 Arithmetic Operation Menu .....	116
Figure 9.4 Operation Result Display Window .....	116
Figure 9.5 Function Operation Menu .....	119
Figure 9.6 Operation Result Display Window .....	119
Figure 9.7 FFT Operation Menu .....	122
Figure 9.8 FFT Operation Window .....	123
Figure 9.9 Peak Search .....	125
Figure 9.10 Logic Operation Menu .....	127
Figure 9.11 Operation Result Display Window .....	128
Figure 9.12 Digital Filter Menu .....	130
Figure 9.13 Operation Result Display Window .....	131
Figure 10.1 Time Parameters .....	135
Figure 10.2 Delay and Phase Parameters .....	138
Figure 10.3 Voltage Parameters .....	139
Figure 10.4 Vertical Measurement Items .....	142

Figure 10.5 Horizontal Measurement Items .....	143
Figure 10.6 Other Measurement Items .....	143
Figure 10.7 Measurement Settings .....	144
Figure 10.8 Cursor .....	148
Figure 10.9 Manual Mode Setting Menu .....	150
Figure 10.10 Manual Cursor Measurement Example .....	152
Figure 10.11 Track Mode Setting Menu .....	153
Figure 10.12 Track Measurement (before Horizontal Expansion) .....	155
Figure 10.13 Track Measurement (after Horizontal Expansion) .....	155
Figure 10.14 XY Mode .....	156
Figure 11.1 DVM Setting Menu .....	159
Figure 11.2 Frequency Counter Setting Menu .....	161
Figure 12.1 Reference Waveform Menu .....	163
Figure 13.1 Pass/Fail Test Menu .....	167
Figure 13.2 Pass/Fail Test Interface .....	170
Figure 14.1 Schematic Diagram of Parallel Decoding .....	172
Figure 14.2 Parallel Decoding Menu .....	173
Figure 14.3 Parallel Decoding Event Table .....	175
Figure 14.4 Schematic Diagram of RS232 Serial Bus .....	176
Figure 14.5 Schematic Diagram of Negative Logic .....	176
Figure 14.6 RS232 Decoding Menu .....	177
Figure 14.7 RS232 Decoding Event Table .....	180
Figure 14.8 I2C Serial Bus .....	181
Figure 14.9 I2C Decoding Menu .....	181
Figure 14.10 I2C Decoding Event Table .....	183
Figure 14.11 SPI Serial Bus .....	184
Figure 14.12 SPI Decoding Menu .....	184
Figure 14.13 SPI Decoding Event Table .....	187
Figure 14.14 LIN Decoding Menu .....	188

---

Figure 14.15 LIN Decoding Event Table .....	190
Figure 14.16 CAN Decoding Menu .....	191
Figure 14.17 Sample Position .....	192
Figure 14.18 CAN Decoding Event Table .....	193
Figure 15.1 "Add Window" Menu .....	195
Figure 16.1 "Record" Menu .....	197
Figure 16.2 Minimized "Play" Menu .....	200
Figure 17.1 Search Menu .....	202
Figure 17.2 MarkTable Display .....	204
Figure 17.3 Navigation Menu .....	205
Figure 17.4 Simplified Navigation Menu .....	205
Figure 18.1 Display Setting Menu .....	207
Figure 18.2 Vector Display .....	208
Figure 19.1 Image Saving Setting Menu .....	212
Figure 19.2 Waveform Saving Setting Menu .....	214
Figure 19.3 Setup Saving Setting Menu .....	215
Figure 19.4 Load Setting Menu .....	220
Figure 19.5 Upgrade Menu .....	221
Figure 19.6 Disk Management Interface .....	222
Figure 20.1 Self-calibration Menu .....	240
Figure 20.2 Quick Menu .....	241
Figure 20.3 Key Test Interface .....	243
Figure 20.4 Touch Screen Test Interface .....	244
Figure 21.1 Search for the Available Device .....	249
Figure 21.2 Confirm the Available Device .....	249

# List of Tables

Table 5.1 Probe Ratio .....	46
Table 8.1 Video Standard .....	77
Table 9.1 Window Function .....	124
Table 9.2 Logic Operation .....	128
Table 14.1 Bus Setting .....	174
Table 19.1 BIN File Format .....	216
Table 19.2 File Header .....	217
Table 19.3 Waveform Header .....	217
Table 19.4 Waveform Data Header .....	219
Table 19.5 Factory Settings .....	223

# 1 Safety Requirement

---

## 1.1 General Safety Summary

---

Please review the following safety precautions carefully before putting the instrument into operation so as to avoid any personal injury or damage to the instrument and any product connected to it. To prevent potential hazards, please follow the instructions specified in this manual to use the instrument properly.

- **Use Proper Power Cord.**

Only the exclusive power cord designed for the instrument and authorized for use within the destination country could be used.

- **Ground the Instrument.**

The instrument is grounded through the Protective Earth lead of the power cord. To avoid electric shock, it is essential to connect the earth terminal of the power cord to the Protective Earth terminal before connecting any inputs or outputs.

- **Connect the Probe Correctly.**

If a probe is used, the probe ground lead must be connected to earth ground. Do not connect the ground lead to high voltage. Improper way of connection could result in dangerous voltages being present on the connectors, controls or other surfaces of the oscilloscope and probes, which will cause potential hazards for operators.

- **Observe All Terminal Ratings.**

To avoid fire or shock hazard, observe all ratings and markers on the instrument and check your manual for more information about ratings before connecting the instrument.

- **Use Proper Overvoltage Protection.**

Ensure that no overvoltage (such as that caused by a bolt of lightning) can reach the product. Otherwise, the operator might be exposed to the danger of an electric shock.

- **Do Not Operate Without Covers.**

Do not operate the instrument with covers or panels removed.

- **Do Not Insert Objects Into the Air Outlet.**

Do not insert objects into the air outlet, as doing so may cause damage to the instrument.

- **Use the Proper Fuse.**

Please use the specified fuses.

- **Avoid circuit or wire exposure.**

Do not touch exposed junctions and components when the instrument is powered on.
- **Do Not Operate With Suspected Failures.**

If you suspect damage occurs to the instrument, have it inspected by RIGOL authorized personnel before further operations. Any maintenance, adjustment or replacement especially to circuits or accessories must be performed by RIGOL authorized personnel.
- **Keep Well Ventilation.**

Inadequate ventilation may cause an increase of temperature in the instrument, which would cause damage to the instrument. So please keep the instrument well ventilated and inspect the air outlet and the fan regularly.
- **Do Not Operate in Wet Conditions.**

To avoid short circuit inside the instrument or electric shock, never operate the instrument in a humid environment.
- **Do Not Operate in an Explosive Atmosphere.**

To avoid personal injuries or damage to the instrument, never operate the instrument in an explosive atmosphere.
- **Keep Instrument Surfaces Clean and Dry.**

To avoid dust or moisture from affecting the performance of the instrument, keep the surfaces of the instrument clean and dry.
- **Prevent Electrostatic Impact.**

Operate the instrument in an electrostatic discharge protective environment to avoid damage induced by static discharges. Always ground both the internal and external conductors of cables to release static before making connections.
- **Use the Battery Properly.**

Do not expose the battery (if available) to high temperature or fire. Keep it out of the reach of children. Improper change of a battery (lithium battery) may cause an explosion. Use the RIGOL specified battery only.
- **Handle with Caution.**

Please handle with care during transportation to avoid damage to keys, knobs, interfaces, and other parts on the panels.

**WARNING**

**Equipment meeting Class A requirements may not offer adequate protection to broadcast services within residential environment.**



## 1.2 Safety Notices and Symbols

### Safety Notices in this Manual:



#### WARNING

Indicates a potentially hazardous situation or practice which, if not avoided, will result in serious injury or death.



#### CAUTION

Indicates a potentially hazardous situation or practice which, if not avoided, could result in damage to the product or loss of important data.

### Safety Symbols on the Product:

- DANGER**  
 It calls attention to an operation, if not correctly performed, could result in injury or hazard immediately.
- WARNING**  
 It calls attention to an operation, if not correctly performed, could result in potential injury or hazard.
- CAUTION**  
 It calls attention to an operation, if not correctly performed, could result in damage to the product or other devices connected to the product.

### Safety Symbols on the Product:



Hazardous  
Voltage



Safety Warning



Protective Earth  
Terminal

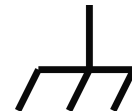

Chassis Ground

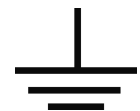

Test Ground

## 1.3 Measurement Category

### Measurement Category

This instrument can make measurements in Measurement Category I.



#### WARNING

This instrument can only be used for measurements within its specified measurement categories.

## Measurement Category Definitions

- **Measurement category I** is for measurements performed on circuits not directly connected to MAINS. Examples are measurements on circuits not derived from MAINS, and specially protected (internal) MAINS derived circuits. In the latter case, transient stresses are variable. Thus, you must know the transient withstand capability of the equipment.
- **Measurement category II** is for measurements performed on circuits directly connected to low voltage installation. Examples are measurements on household appliances, portable tools and similar equipment.
- **Measurement category III** is for measurements performed in the building installation. Examples are measurements on distribution boards, circuit-breakers, wiring (including cables, bus-bars, junction boxes, switches and socket-outlets) in the fixed installation, and equipment for industrial use and some other equipment. For example, stationary motors with permanent connection to a fixed installation.
- **Measurement category IV** is for measurements performed at the source of a low-voltage installation. Examples are electricity meters and measurements on primary overcurrent protection devices and ripple control units.

## 1.4 Ventilation Requirement

This instrument uses a fan to force cooling. Please make sure that the air inlet and outlet areas are free from obstructions and have free air. When using the instrument in a bench-top or rack setting, provide at least 10 cm clearance beside, above and behind the instrument for adequate ventilation.



### CAUTION

Inadequate ventilation may cause an increase of temperature in the instrument, which would cause damage to the instrument. So please keep the instrument well ventilated and inspect the air outlet and the fan regularly.

## 1.5 Working Environment

### Temperature

Operating: 0°C to +50°C

Non-operating: -30°C to +60°C

### Humidity

- **Operating:**
  - Below +30°C: ≤90% RH (without condensation)
  - +30°C to +40°C: ≤75% RH (without condensation)

+40°C to +50°C: ≤45% RH (without condensation)

- **Non-operating:**

Below +60°C: ≤90% RH (without condensation)



**WARNING**

To avoid short circuit inside the instrument or electric shock, never operate the instrument in a humid environment.

**Altitude**

- **Operating:** below 3 km
- **Non-operating:** below 15 km

**Protection Level Against Electric Shock**

ESD ±8kV

**Installation (Overvoltage) Category**

This product is powered by mains conforming to installation (overvoltage) category II.



**WARNING**

Ensure that no overvoltage (such as that caused by a bolt of lightning) can reach the product. Otherwise, the operator might be exposed to the danger of an electric shock.

**Installation (Overvoltage) Category Definitions**

Installation (overvoltage) category I refers to signal level which is applicable to equipment measurement terminals connected to the source circuit. Among these terminals, precautions are done to limit the transient voltage to a low level.

Installation (overvoltage) category II refers to the local power distribution level which is applicable to equipment connected to the AC line (AC power).

**Pollution Degree**

Pollution Degree 2

**Pollution Degree Definition**

- **Pollution Degree 1:** No pollution or only dry, nonconductive pollution occurs. The pollution has no effect. For example, a clean room or air-conditioned office environment.
- **Pollution Degree 2:** Normally only nonconductive pollution occurs. Temporary conductivity caused by condensation is to be expected. For example, indoor environment.

- **Pollution Degree 3:** Conductive pollution or dry nonconductive pollution that becomes conductive due to condensation occurs. For example, sheltered outdoor environment.
- **Pollution Degree 4:** The pollution generates persistent conductivity caused by conductive dust, rain, or snow. For example, outdoor areas.

### Safety Class

Class 1 – Grounded Product

## 1.6 Care and Cleaning

### Care

Do not store or leave the instrument where it may be exposed to direct sunlight for long periods of time.

### Cleaning

Clean the instrument regularly according to its operating conditions.

1. Disconnect the instrument from all power sources.
2. Clean the external surfaces of the instrument with a soft cloth dampened with mild detergent or water. Avoid having any water or other objects into the chassis via the heat dissipation hole. When cleaning the LCD, take care to avoid scarifying it.

### CAUTION

To avoid damage to the instrument, do not expose it to caustic liquids.



### WARNING

To avoid short-circuit resulting from moisture or personal injuries, ensure that the instrument is completely dry before connecting it to the power supply.



## 1.7 Environmental Considerations

The following symbol indicates that this product complies with the WEEE Directive 2002/96/EC.



The equipment may contain substances that could be harmful to the environment or human health. To avoid the release of such substances into the environment and avoid harm to human health, we recommend you to recycle this product

appropriately to ensure that most materials are reused or recycled properly. Please contact your local authorities for disposal or recycling information.

You can click on the following link <https://int.rigol.com/services/services/declaration> to download the latest version of the RoHS&WEEE certification file.

## 2 Product Features

### Product Features

- Brand-new chipset "Centaurus" developed by RIGOL
- Ultra-low noise floor for cleaner signals, measuring small signals accurately
- 12-bit vertical resolution<sup>[1]</sup>
- Up to 200 MHz analog bandwidth, 2/4 analog channels, and 1 EXT channel
- Up to 2 GSa/s real-time sample rate
- Max. memory depth: 100 Mpts (optional)
- Vertical sensitivity range: 500  $\mu$ V/div to 10 V/div
- Up to 1,500,000 wfms/s waveform capture rate with the UltraAcquire mode
- 10.1" 1280\*800 HD touch display
- User-friendly Flex Knobs, bringing smoother interaction
- Standard photoelectric encoder operating knobs, effectively prolonging its service life
- Standard USB Device & Host, LAN, and HDMI interfaces

HDO1000 series digital oscilloscope is designed to meet the designing, debugging, and testing requirements of the mainstream oscilloscope market. Adopting the brand-new chipset "Centaurus" developed by RIGOL, this series achieves a fast waveform capture rate of 1,500,000 wfms/s with the UltraAcquire mode, 100 Mpts memory depth, 12-bit vertical resolution, all combined with excellent noise floor performance and vertical accuracy to meet your requirements for more accurate measurements, bringing extraordinary T&M experience for you.



### NOTE

[1]: 16 bits in High Resolution mode.

## 3 Document Overview

This manual gives you a quick overview of the front and rear panel, user interface as well as basic operation methods of HDO1000 series.



### TIP

For the newest version of this manual, download it from RIGOL official website (<http://www.rigol.com>).

### Publication Number

UGA32100-1110

### Software Version

Software upgrade might change or add product features. Please acquire the latest version of the manual from RIGOL website or contact RIGOL to upgrade the software.

### Format Conventions in this Manual

#### 1. Key

The front panel key is denoted by the menu key icon. For example,  indicates the "DEFAULT" key.

#### 2. Menu

The menu item is denoted by the format of "Menu Name (Bold) + Character Shading" in the manual. For example, **Setup** indicates the "Setup" sub-menu under the "Utility" function menu. You can click or tap **Setup** to access the "Setup" menu.



#### 3. Operation Procedures





The next step of the operation is denoted by ">" in the manual. For example,  >

> **Storage** indicates first clicking or tapping  and then clicking or tapping **Storage**.

4. The front/rear panel connector is denoted by "Brackets + Connector Name (Bold)", for example, [**AUX OUT**].

#### 5. Knob

Label	Knob	Label	Knob
<b>Horizontal POSITION</b> 	Horizontal Position Knob	 <b>1</b>	Multipurpose Knob 1

Label	Knob	Label	Knob
Horizontal  <u>SCALE</u>	Horizontal Scale Knob	 <u>2</u>	Multipurpose Knob 2
Vertical  <u>POSITION</u>	Vertical Position Knob	 <u>LEVEL</u>	Trigger Level Knob
Vertical  <u>SCALE</u>	Vertical Scale Knob	-	-

### Content Conventions in this Manual

HDO1000 series digital oscilloscope includes 2-channel and 4-channel models which share the same operation methods. Unless otherwise specified, this manual takes the 4-channel model HDO1104 as an example to illustrate the basic operation methods of HDO1000 series.

Model	Max. Analog Bandwidth	Analog Channels
HDO1072	70 MHz	2
HDO1074	70 MHz	4
HDO1102	100 MHz	2
HDO1104	100 MHz	4
HDO1202	200 MHz	2
HDO1204	200 MHz	4



## 4 Quick Start

### 4.1 General Inspection

#### 1. Inspect the packaging

If the packaging has been damaged, do not dispose the damaged packaging or cushioning materials until the shipment has been checked for completeness and has passed both electrical and mechanical tests.

The consigner or carrier shall be liable for the damage to the instrument resulting from shipment. RIGOL would not be responsible for free maintenance/rework or replacement of the instrument.

#### 2. Inspect the instrument

In case of any mechanical damage, missing parts, or failure in passing the electrical and mechanical tests, contact your RIGOL sales representative.

#### 3. Check the accessories

Please check the accessories according to the packing lists. If the accessories are damaged or incomplete, please contact your RIGOL sales representative.

#### Recommended Calibration Interval

RIGOL suggests that the instrument should be calibrated every 18 months.

### 4.2 Appearance and Dimensions

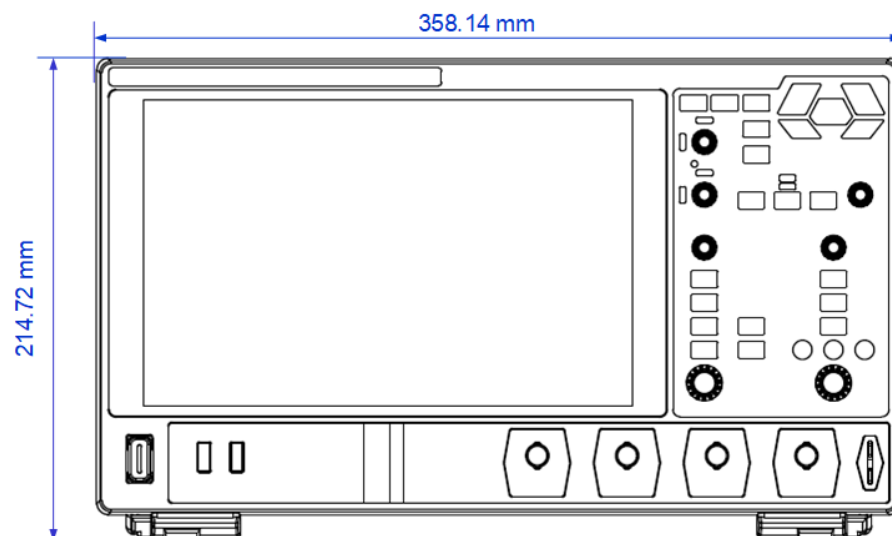

Figure 4.1 Front View

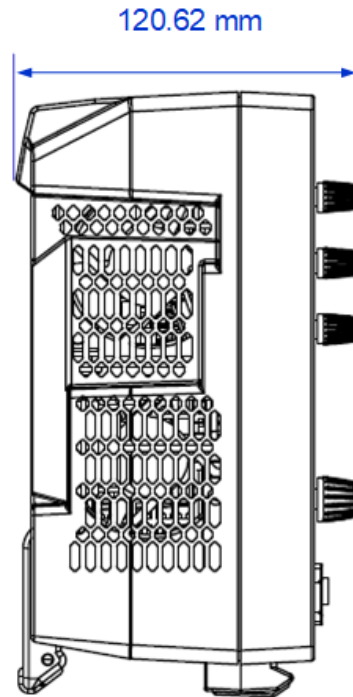

Figure 4.2 Side View

## 4.3 To Prepare for Use

### 4.3.1 Tilting the Oscilloscope for Easier Viewing

Flip out the tabs under the oscilloscope's rear feet to tilt the oscilloscope to stabilize it for easier operation and viewing. Flip in the tabs for storage or transporting when not using the instrument. Please see the figure below.

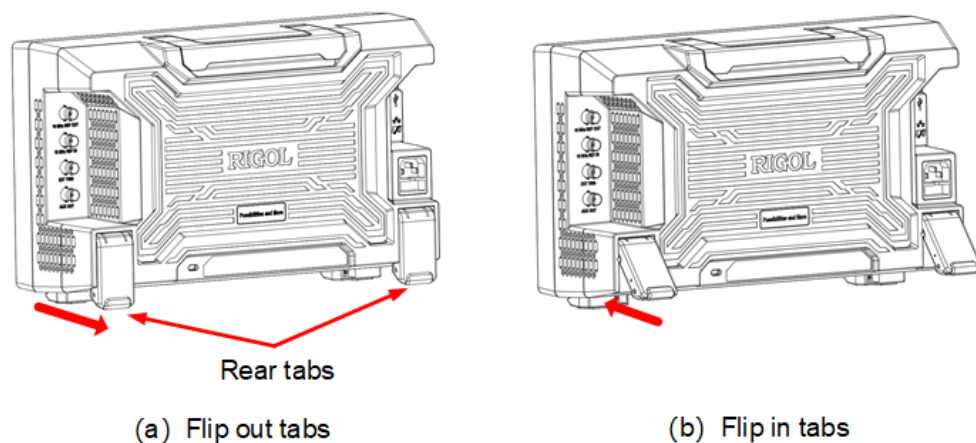
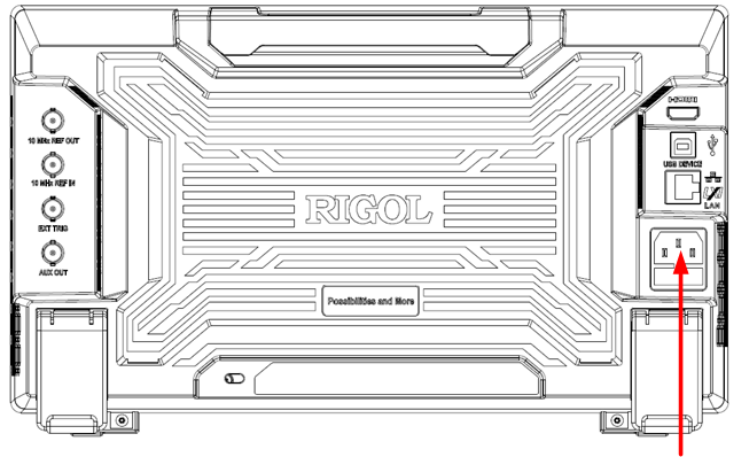

Figure 4.3 Flipping in/out Tabs

### 4.3.2 Connecting to Power

The power requirements of the oscilloscope are 100-240 V, 45-440 Hz. Please use the power cord provided in the accessories to connect the oscilloscope to the AC power source, as shown in the figure below.



Power Cord Connector

Figure 4.4 Connecting to Power







#### WARNING

To avoid electric shock, ensure that the instrument is correctly grounded.

### 4.3.3 Turn-on Checkout

After the instrument is connected to the power source, press the power switch  at the lower-left corner of the front panel to power on the instrument. During the start-up process, the instrument performs a series of self-tests. After the self-test, the splash screen is displayed.

- **Restart:** Click or tap  > **Restart**. Then a prompt message "Are you sure to reboot?" is displayed. Click or tap **OK** to restart the instrument.
- **Shutdown:**
  - Click or tap  > **Shutdown**. Then a prompt message "Are you sure to shutdown?" is displayed. Click or tap **OK** to shut down the instrument.
  - Press the power switch  and a prompt message "Are you sure to shutdown?" is displayed. Click or tap **OK** to shut down the instrument.
  - Press  twice to directly shut down the instrument.

- Press **0** for three seconds to directly shut down the instrument.

**TIP**

You can also click or tap  > **Utility** > **Setup** and select "Switch On" in "Power Status" item. In this way, the instrument powers on once connected to power.

### 4.3.4 Replacing the Fuse

If you need to replace the fuse, please use the correct fuse (AC 250 V, T3.15 A; 5.2 mm×20 mm) and follow the steps shown below (see [Figure 4.5](#)).

1. Power off the instrument and remove the power cord.
2. Insert a small straight screwdriver into the slot at the power socket and pry out the fuse holder gently.
3. Remove the fuse.
4. Insert the proper fuse into the fuse holder.
5. Re-insert the fuse holder into the power socket.

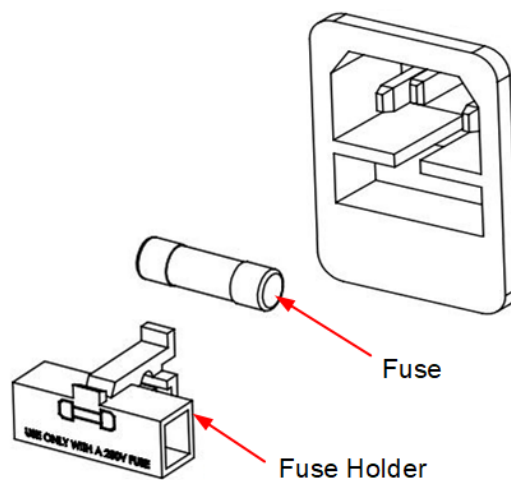



Figure 4.5 Replacing the Fuse

**WARNING**

To avoid electric shock, please make sure that the instrument is powered off and disconnected from the power before replacing the fuse. Also, please make sure the fuse is consistent with the required fuse rating.

### 4.3.5 Setting the System Language

This oscilloscope supports multiple languages. You can click or tap  > **Utility** > **Setup** > **Language** to select the system language.

### 4.3.6 Connecting Probes

RIGOL provides passive probes for HDO1000 series. For specific probe models, please refer to *HDO1000 series Data Sheet*. For detailed technical information of the probes, please refer to the corresponding Probe User Guide.

#### Connect the Passive Probe

1. Connect the BNC terminal of the probe to an analog channel input terminal of the oscilloscope on the front panel as shown in the figure below.
2. Connect the ground alligator clip or spring of the probe to the circuit ground terminal, and then connect the probe tip to the circuit point to be tested.

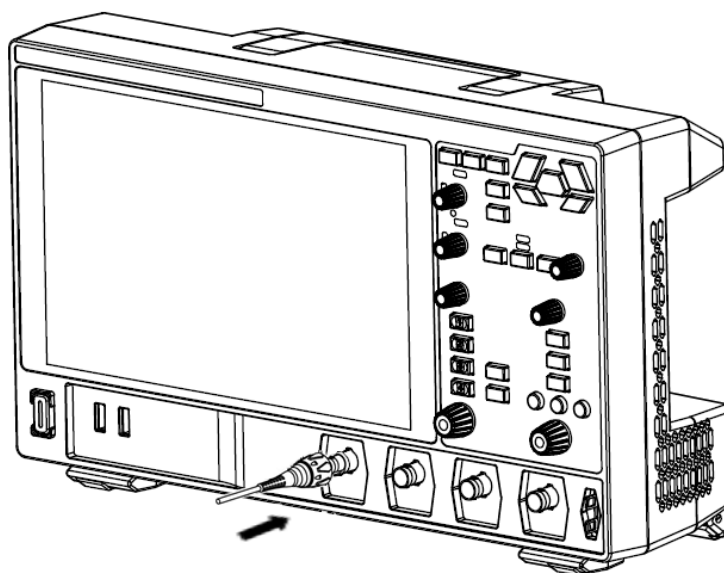



Figure 4.6 Connecting the Passive Probe

After you connect the passive probe, check the probe function and probe compensation adjustment before making measurements. For details, please refer to *Function Inspection* and *Probe Compensation*.

### 4.3.7 Function Inspection

1. Press the front-panel  and a prompt message "Restore default settings?" is displayed. Click or tap **OK** to restore the instrument to its factory default settings.

2. Connect the ground alligator clip of the probe to the "Ground Terminal" as shown in *Figure 4.7*.
3. Use the probe to connect the input terminal of CH1 and the "Compensation Signal Output Terminal" of the probe, as shown in *Figure 4.7*.

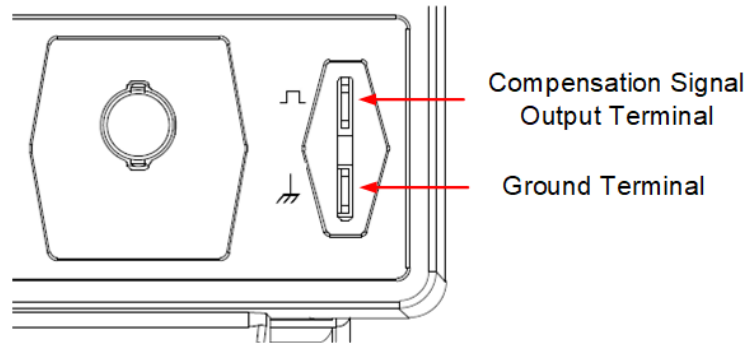

**Figure 4.7 Using the Compensation Signal**

4. Set the probe ratio based on the attenuation of the probe, and then click or tap  > **Auto**.
5. Observe the waveform on the display. In normal condition, you should see a square waveform similar to the waveform shown in the figure below.

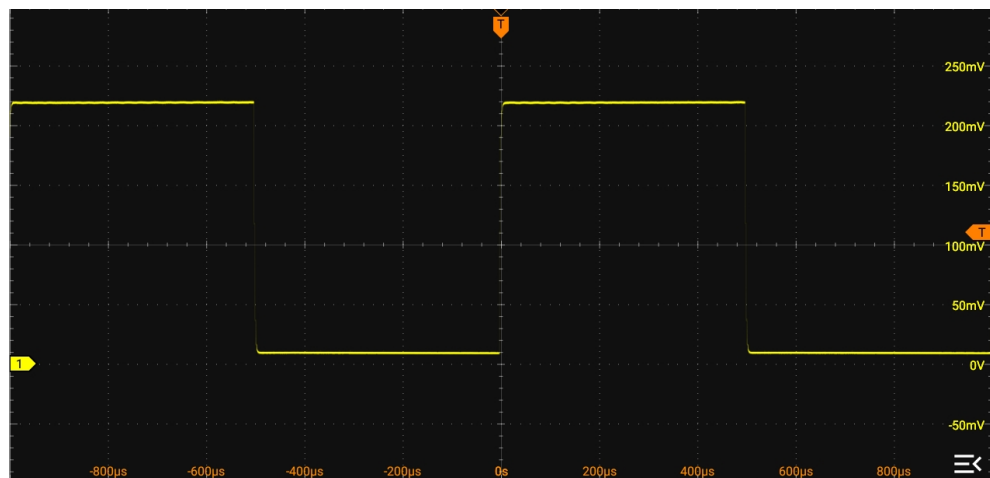

**Figure 4.8 Square Waveform Signal**

6. Test the other channels in the same way. If you see the waveform, but the square wave is not shaped correctly as shown above, perform the procedure described in *Probe Compensation*. If you do not see the waveform, perform the inspection again.



**WARNING**

To avoid electric shock when using the probe, please make sure that the insulated wire of the probe is in good condition. Do not touch the metallic part of the probe when the probe is connected to high voltage source.

### 4.3.8 Probe Compensation

When used for the first time, the oscilloscope probe must be compensated to match the input characteristics of the oscilloscope channel to which it is connected. A non-compensated or poorly compensated probes can introduce measurement inaccuracy or errors. The compensation procedure is as follows:

1. Perform step 1, 2, 3, and 4 in *Function Inspection*.
2. Check the displayed waveforms and compare them with waveforms shown in the figure below.

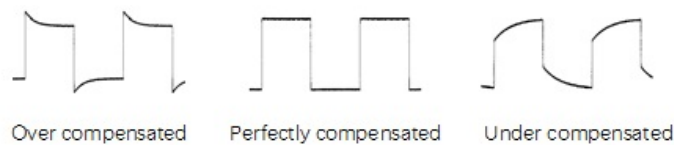

**Figure 4.9 Probe Compensation**

3. Use the probe compensation adjustment tool provided in the accessories to adjust the low-frequency compensation adjustment hole on the probe until the displayed waveform is consistent with the "Perfectly compensated" waveform shown in the figure above.

## 4.4 Product Overview

The following content provides a description of the front and rear panels as well as the user interface of the HDO1000 series by taking 4-channel model HDO1104 as an example.

### 4.4.1 Front Panel Overview

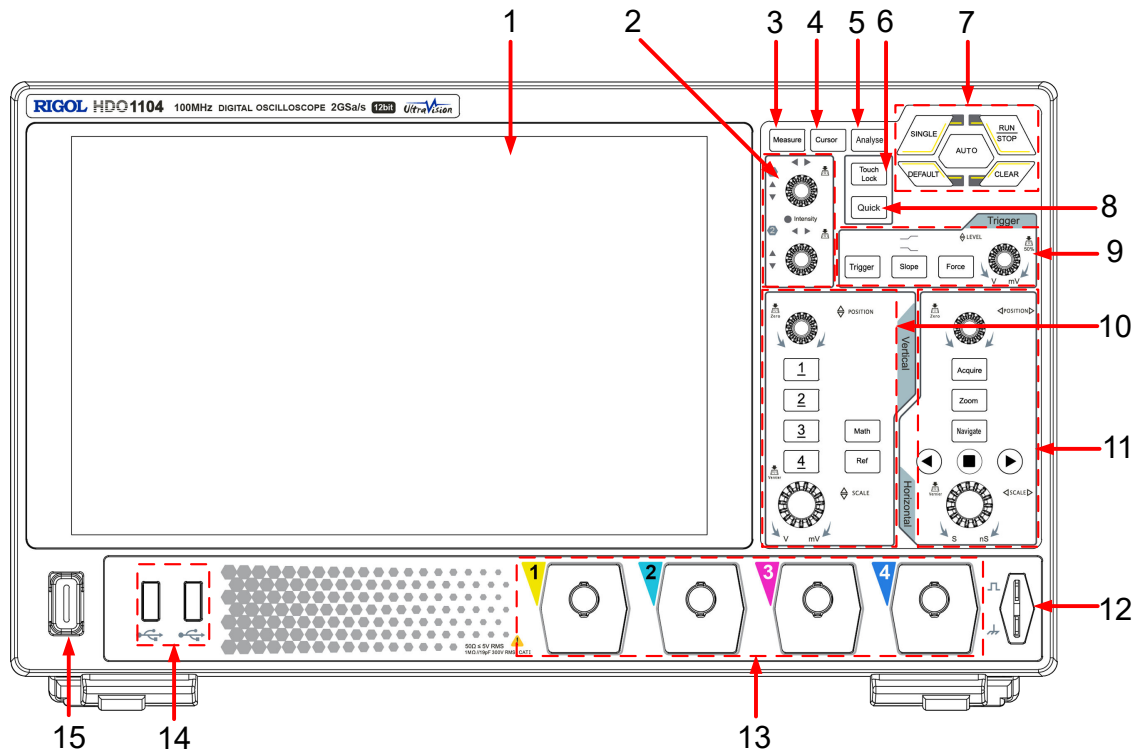
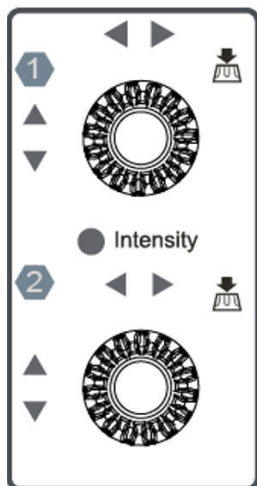

Figure 4.10 Front Panel

#### 1. 10.1-inch Capacitive Touch Screen

Displays the waveforms, menu labels, and parameter settings, system state, prompt messages, and other information.

#### 2. Multipurpose Knobs



- **Non-menu operation:**

When not operating on the menu, you can rotate the knob 1 to adjust the waveform brightness. When a cursor, decoding, Math waveform, or reference



waveform is added on the screen, you can rotate the multipurpose knob to move the cursor (knob 1 and 2), adjust the decode threshold (knob 1), adjust the vertical scale (knob 1) and vertical offset (knob 2) of the math/reference waveform. You can click or tap **Flex Knob** in the Toolbar at the upper-right of the screen to set priority.

- Automatic: default priority, Cursor>Math>Ref>Decode>Intensity.
- Manual: all non-menu operation items are listed at the lower part of the **Flex Knob** menu. You can select one of them as the current item for multipurpose knob to adjust.

#### - **Menu operation:**

When operating on the menu, you can rotate the multipurpose knob 1/2 to adjust the value in the menu. When you click or tap an input field and then the **1 / 2** icon is displayed in the input field, it indicates that you can use multipurpose knob 1/2 to set the value. The LED indicator of the corresponding knob is illuminated. In this point, you can rotate the knob to adjust the value or press the knob to restore the parameter to the default value.

When using the virtual numeric keypad or drop-down list, you can rotate the knob to navigate through the keypad or drop-down list and press the knob to select an item.

### 3. Measure Key

Press  to access the Measure menu. You can set the source and select the waveform parameters in the menu. For details, please refer to [Measurements](#).

### 4. Cursor Key

Press  to enable cursor measurements. The results are displayed in the right-side "Result" window. Three cursor modes are available: Manual, Track, and XY; wherein, the XY mode is available only when the time mode is set to "XY".

### 5. Analyse Key





Press  to access the Analyse menu, in which you can access analysis features including digital voltmeter (DVM), counter, , waveform recording, and pass/fail testing.

### 6. Touch Lock Key

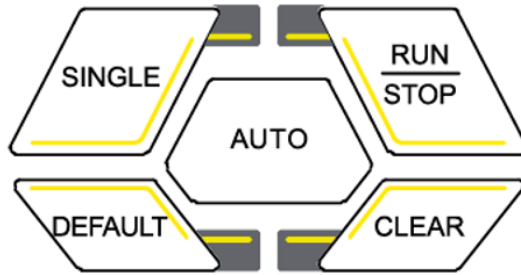
Press  once to disable the touch screen function; press it again to enable the touch screen function.

### 7. Quick Key





-  is the auto scale key. Press this key to enable the auto scale function. The oscilloscope is automatically configured to best display the input signals by adjusting the vertical scale, horizontal timebase, and trigger mode. To set up the key, please refer to [Auto Config](#).
-  is the RUN/STOP key. Press the key to set the oscilloscope's run state to "RUN" or "STOP". When the oscilloscope is stopped, this key is illuminated in red.
-  is the key for a single acquisition. Press this key to set the oscilloscope's trigger mode to "Single".
-  is the default setup key. Press this key to restore the oscilloscope's default settings.
-  is the clear key. Press this key to clear all waveform on the display. If the oscilloscope is in "RUN" mode, it continues to display new waveforms.

## 8. Quick Action Key

Press  to perform the selected quick action: print screen, save wave, save setup, measure all, statistics reset, waveform record, or save group. To set up the key, please refer to [Quick Action Settings](#).

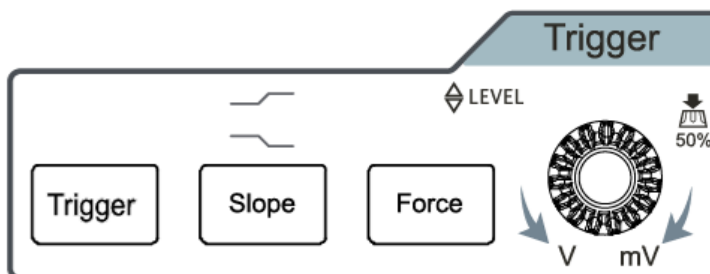
## 9. Trigger Controls



-  is trigger setup key. Press this key to access the Trigger menu. For details, please refer to [Triggering the Oscilloscope](#).

- **Slope** is the slope setup key. Press this key to select the edge type (rising edge, falling edge, or either edge). This key is not active when the trigger type is not set to "Edge".
- **Force** is the force trigger key. Press this key to force a trigger.
- **LEVEL** is the trigger level/digital threshold knob. Turn the knob clockwise to increase the trigger level or turn the knob counterclockwise to decrease the level. Pressing the knob can quickly set the trigger level to the waveform's 50% peak-to-peak value.

## 10. Vertical Controls

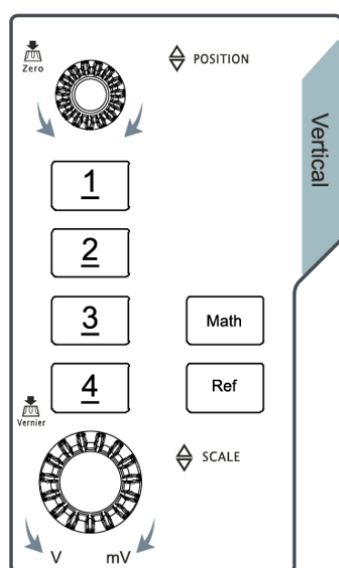



- **Vertical POSITION** is the vertical position knob. Turn this knob to change the selected waveform's vertical position to move the waveform up or down on the display. Press this knob to reset the vertical position to zero.
- **Vertical SCALE** is the vertical scale knob. Turn this knob to modify the value of vertical divisions of the graticule in volts/div. Press this knob to toggle between fine and coarse adjustment of the vertical scale.
- **Ref** is the reference key. Press this key to assess the Ref menu, in which you can add reference waveforms in waveform view and compare them with measured waveforms to identify circuit fault.
- **Math** is the Math key. Press this key to access the Math menu. Math operations include  $A+B$ ,  $A-B$ ,  $A \times B$ ,  $A/B$ , FFT, etc. You can also set the Math label.
- **1/2/3/4** is the channel key. Press the key to enable (display), select, or disable the corresponding channel, as described below:



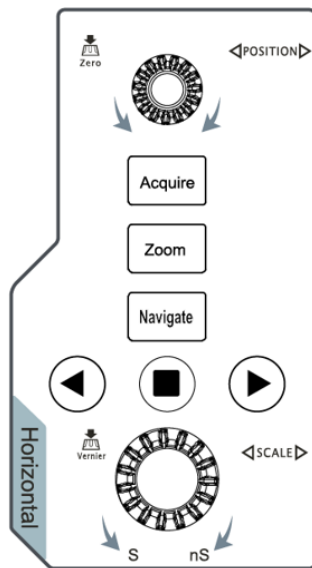

- If the channel is not displayed, you can press the channel key to open the channel in the waveform view window.
- If the channel is displayed but not selected, you can press the channel key to select the channel.
- If the channel is both displayed and selected, you can press the channel key to close its display in the waveform view.

For two-channel models (HDO1072/HDO1102/HDO1202), only two channel keys ( and ) are available.

## 11. Horizontal Controls



- **Horizontal  POSITION** is the horizontal position knob. Turn the knob to change the horizontal position (trigger position) to move the waveforms horizontally. Press the knob to reset the horizontal position to default.
- **Horizontal  SCALE** is the horizontal scale knob. Turn the knob to change the horizontal time/div setting to compress or expand waveforms of all channels horizontally. Press this knob to toggle between fine and coarse adjustment of the horizontal scale.
- is the acquisition setup key. Press this key to access the Horizontal menu where you can set the oscilloscope's time base mode, acquisition mode, memory depth, etc.
- is the Zoom (delayed sweep) key. Press this key to enable or disable the Zoom mode.

-  is the Navigate key. Press this key to access the Navigation menu where you can navigate time, search events, or segments. For details, please refer to [Navigation](#).
-    are the navigation keys.

## 12. Probe Compensation Signal Output Terminal/Ground Terminal

This terminal outputs the probe compensation signal which helps you match a probe's input capacitance to the oscilloscope channel to which it is connected. For details, please refer to [Probe Compensation](#).

## 13. Analog Channel Input Terminals

Attach probes to these connectors for analog signal inputs.

For two-channel models (HDO1072/HDO1102/HDO1202), only two input terminals are available.

## 14. USB HOST Port

This series supports the flash memory USB storage device of FAT32 format and USB-GPIB module.

- **USB storage device:** imports or exports data (software update, waveform, setup, or captured image).
- **USB-GPIB module:** extends the GPIB interface for RIGOL instruments that integrates the USB HOST interface but not the GPIB interface.

## 15. Power Switch

Press the switch to power on/off the oscilloscope.

## 4.4.2 Rear Panel Overview

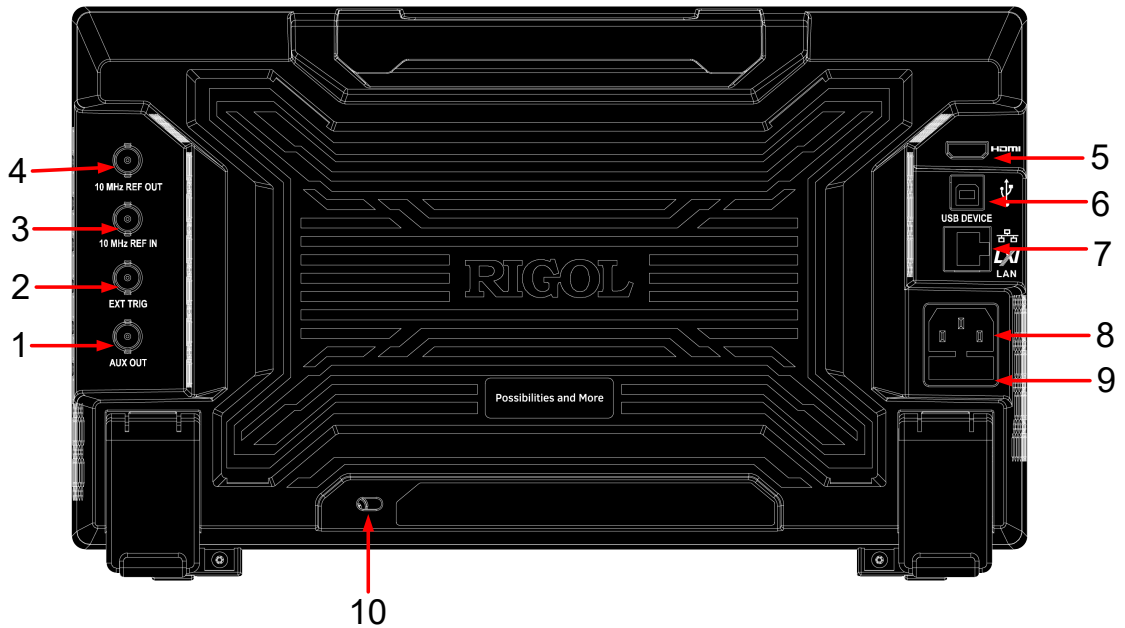

Figure 4.11 Rear Panel

### 1. AUX OUT

#### - Trigger output:

The oscilloscope can output a signal that can reflect the current capture rate of the oscilloscope at each trigger via this interface. Connect the signal to a waveform display device and measure the frequency of the signal. The measurement result is the same as the current capture rate.

#### - Pass/Fail:

In the pass/fail test, the instrument will output a pulse via the **[AUX OUT]** connector when a passed or failed waveform is detected during the pass/fail test.

### 2. EXT TRIG

BNC connector to input external trigger signal for the oscilloscope.

### 3. 10 MHz REF IN

BNC connector to input external reference clock signal.

### 4. 10 MHz REF OUT

BNC connector that can output the 10 MHz clock signal generated by the internal crystal oscillator inside the instrument.

### 5. HDMI

You can connect the instrument to an external display that has the HDMI interface (e.g. monitor or projector) via this interface to better observe the waveform display clearly. At this time, you can also view the waveforms on the LCD of the instrument.

## **6. USB DEVICE**

Connect the instrument to the PC via this interface. Then you can use the PC software Ultra Scope to send the SCPI commands or use the user-defined programming to control the instrument.

## **7. LAN**

Connect the instrument to network via this interface. The instrument conforms to LXI CORE 2011 DEVICE instrument standard. Its test system can be built quickly. Then you can control the instrument through using Web Control to send the SCPI commands to control the instrument. When update is available, you can perform online upgrading for the system software of the instrument via the LAN interface.

## **8. AC Power Cord Connector**

The power requirements of the instrument are 100 V to 240 V, 45 Hz to 440 Hz. The maximum input power is no more than 500 W. Please use the power cord provided in the accessories to connect the instrument to the AC power source.

## **9. Fuse**

If you need to replace the fuse, use only the specified fuse.

## **10. Security Lock Hole**

Use a standard PC/laptop lock cable to secure the oscilloscope to a work bench or other location.

### 4.4.3 User Interface Overview

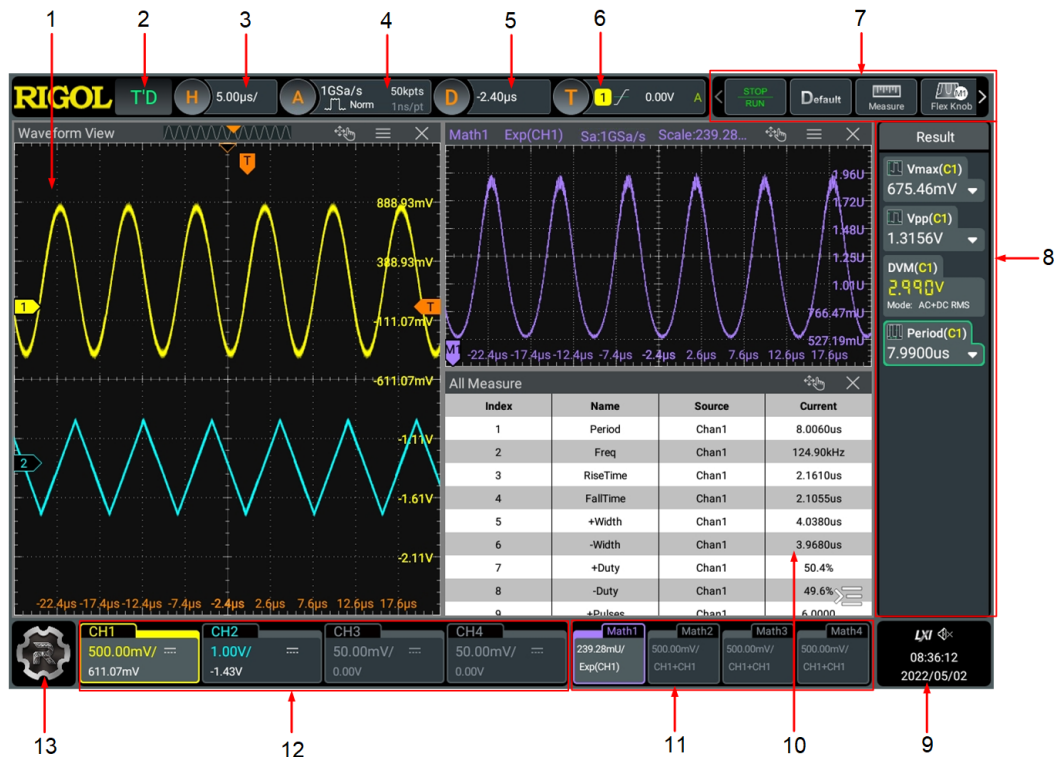



Figure 4.12 User Interface

#### 1. Waveform View

Displays the measurement waveform window for CH1-CH4. Click or tap  at the upper-right corner of the window to close the window; click or tap  to enter the configuration menu of the specified function.

#### 2. Run State Label

Displays the operating status of the instrument.

#### 3. Horizontal Timebase Label

Displays the current horizontal time base. Click or tap this label to enter the horizontal setting menu.

#### 4. Sample Rate & Memory Depth Label

Displays the current sample rate and memory depth. Click or tap this label to enter the horizontal setting menu.

#### 5. Horizontal Delay Label

Displays the current horizontal position. Click or tap this label to enter the horizontal setting menu.



## 6. Trigger Label

- Displays the trigger information of the system, including the trigger type, trigger level, trigger mode, and etc.
- Click or tap the trigger label, then the trigger setting window is displayed. You can set the parameters for the trigger.

## 7. Function Toolbar





Provides **STOP/RUN**, **XY**, **Default**, **Flex Knob**, **Navigate** keys and some function keys in the function navigation menu.

## 8. Result Sidebar

Displays the measurement results and statistics of various functions. Click or tap  at the lower-right corner of the screen to open or close the "Result" sidebar.

## 9. Notification Area

Displays USB icon, LAN icon, the sound icon, remote control icon as well as data and time. You can click or tap this area to open the "Utility" menu.

- USB storage device icon: When a USB storage device is detected,  will be displayed.
- LAN icon: When the LAN interface is successfully connected,  is displayed.
- Sound icon: In the "Utility" menu, click or tap **Setup** > **Beeper** to enable or disable the sound. When on,  will be displayed; when off,  will be displayed. You can simply click or tap the icon to enable or disable the sound.
- Remote control icon: When you use Web Control to control the instrument remotely,  will be displayed.
- Date and time: displays the system date and time. For how to set the data and time, please refer to *Display Date and Time*.

## 10. Split-screen Display

If you enable multiple functions, multiple windows can be displayed on the screen at one time.

## 11. Math Labels

Displays the on/off state, operation type, and vertical scale.

## 12. Channel Labels

- Display the on/off status of CH1~CH4.
- Display the channel coupling mode.

- Display the vertical scale.
- Display the vertical offset.

**NOTE**

For two-channel models (HDO1072/HDO1102/HDO1202), only two channel labels are available.

**13. Function Navigation Icon**

Click or tap the icon to open the function navigation menu in which you can access the specified function menu by clicking or tapping the corresponding function key.

## 4.5 Touch Screen Gestures

The instrument's large capacitive touch screen makes operation and configuration easy and flexible. The highly sensitive user interface designed for touch has a strong waveform display capability, bringing an extraordinary user experience. The actions supported by the touch screen controls include tapping, pinching&stretching, as well as dragging.

### 4.5.1 Tap

Use one finger to tap the symbol or characters on the screen slightly, as shown in *Figure 4.13*. With the Tap gesture, you can perform the following operations:

- Tap the menu displayed on the screen to operate on the menu.
- Tap the function navigation icon at the lower-left corner of the touch screen to enable the function navigation.
- Tap the displayed numeric keypad to set the parameters.
- Tap the virtual keypad to set the filename.
- Tap the close button at the upper-right corner of the message box to close the prompt window.
- Tap other windows on the touch screen and operate on the windows.



Figure 4.13 Tap Gesture

## 4.5.2 Pinch&Stretch

Pinch or stretch two points on the screen with two fingers to zoom in or out the waveform. To zoom in the waveform, first pinch the two fingers and then stretch the fingers; to zoom out the waveform, first stretch the two fingers, and then pinch the fingers together, as shown in the figure below. With the pinch&stretch gesture, you can perform the following operation:

- Pinching&stretching in the horizontal direction can adjust the horizontal time base of the waveform.
- Pinching&stretching in the vertical direction can adjust the vertical scale of the waveform.



Figure 4.14 Pinch&Stretch Gesture

## 4.5.3 Drag

Use one finger to select the object, and then drag the object to a destination place, as shown in the figure below. With the drag gesture, you can perform the following operation:

- Drag the waveform to change its position or scale.

- Drag the window controls to change the position of the window (e.g. numeric keypad).
- Drag the cursor to move the cursor.
- Drag the trigger cursor to change the trigger level.
- In multi-window display, drag one of the displayed windows to change its position on the display.

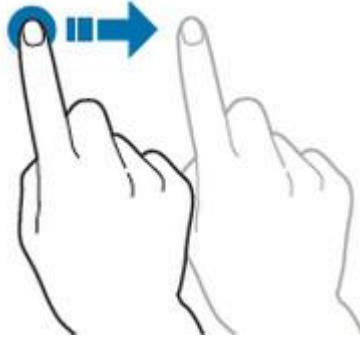

Figure 4.15 Drag Gesture

## 4.6 Parameter Setting Method

For this instrument, you can use the knobs and touch screen to set parameters. The common parameter setting methods are as follows:

- **Method 1:** Some parameters can be adjusted by rotating the front-panel knobs.
- **Method 2:** Click or tap the input field of a specified parameter, then a virtual keypad is displayed. Complete the parameter setting with the keypad.

### Input Chinese and English Characters

When naming a label, this instrument supports Chinese/English input method. The following part introduces how to input Chinese and English characters with the Chinese/English input method.

- **Input English Characters**

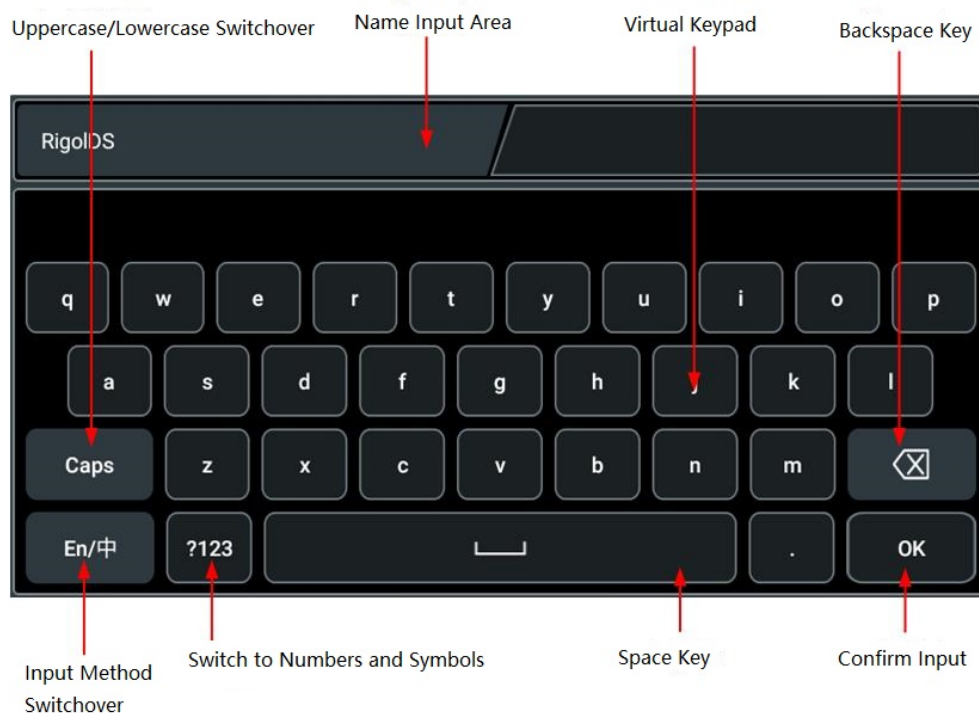

**Figure 4.16 English Input Interface**

### 1. Select English input method

First check the input method type. If it shows "En/中", then go to Step 2; if it shows "中/En", click or tap the input method swichover key to switch to "En/中" (English input method).

### 2. Clear the name input area

If there is no character in the "Name Input Area", please go to the next step. If there are characters in the "Name Input Area", click or tap the Backspace key to delete all the characters from the "Name Input Area" in order.

### 3. Input the upper-case letter

If you want to input an upper-case letter, first use the Caps key to switch between the upper-case and lower-case mode. If the Caps key is selected, input the upper-case letter with the virtual keypad. If not, first click or tap the Caps key to ensure it is selected, then input the upper-case letter. All the input letters will be displayed in the "Name Input Area".

### 4. Input the lower-case letter

Refer to the operation specified in the previous step. If the Caps key is not selected, directly input the lower-case letter.

### 5. Input numbers or symbols

If the letter keypad is displayed, you need to click or tap the numeric swichover key to switch to the numeric keypad, and input numbers or

symbols with the numeric keypad. All the input letters will be displayed in the "Name Input Area".

#### 6. Modify or delete the unwanted characters that have been input

During the name input process, you can modify or delete the unwanted character if necessary. To delete the characters that have been input, click or tap the Backspace key in the virtual keypad to delete the characters. To modify the characters that have been input, delete the unwanted characters first and then input the new characters.

You can directly move the cursor to the character to be modified or deleted, delete the desired character or input the new characters after deleting the unwanted character.

#### 7. Confirm the input

After completing the input operation, click or tap "OK".

- **Input Chinese Characters**



**Figure 4.17 Chinese Input Interface**

#### 1. Select Chinese input method

First check the input method type. If it shows "中/En", then go to Step 2; if it shows "En/中", click or tap the input method switchover key to switch to "中/En" (Chinese input method).

#### 2. Clear the name input area

If there is no character in the "Name Input Area", please go to the next step. If there are characters in the "Name Input Area", click or tap the Backspace key to delete all the characters from the "Name Input Area" in order.

If there are characters in the "Pinyin Input Area", when you delete characters from the name input area, the characters in the Pinyin input area will be deleted first.

### 3. Input Chinese characters

Click or tap the characters in the virtual keypad to input Pinyin into the input area, then the characters to be selected will be displayed in the Chinese character selection area. Slide to view more Chinese characters for you to choose. Select the desired Chinese character, and then the selected character will be displayed in the input area.

### 4. Modify or delete the unwanted characters that have been input

During the name input process, you can modify or delete the unwanted character if necessary. To delete the characters that have been input, click or tap the Backspace key in the virtual keypad to delete the characters. To modify the characters that have been input, delete the unwanted characters first and then input the new characters.

### 5. Confirm the input

After completing the input operation, click or tap "OK".

## Input a String

When naming a file or folder, you need to input a string with the keypad.

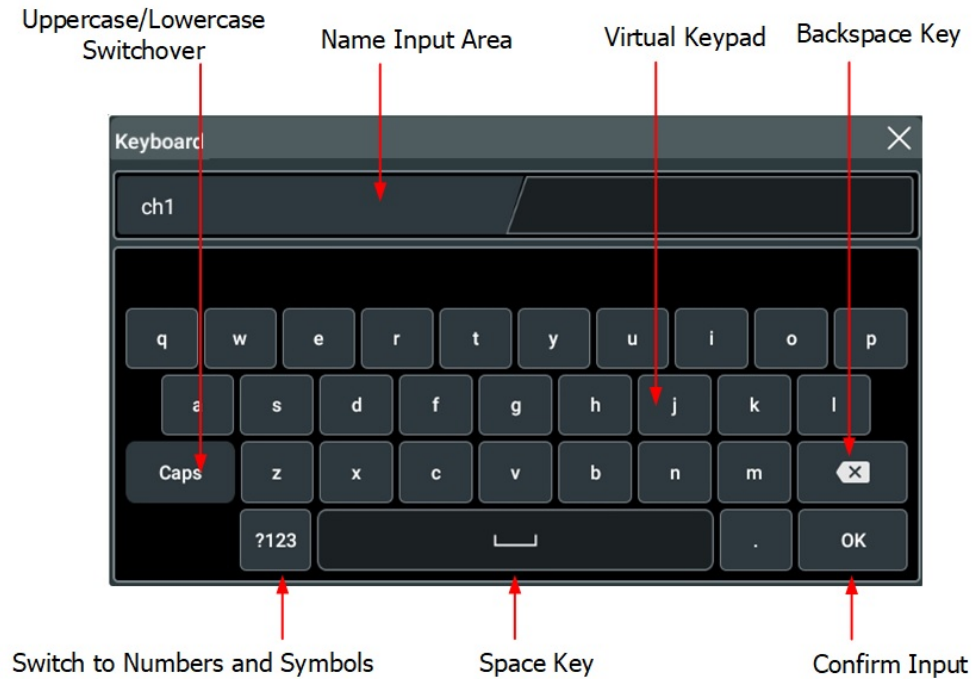

**Figure 4.18 String Keypad**

**1. Clear the name input area**

If there is no character in the "Name Input Area", please go to the next step. If there are characters in the "Name Input Area", click or tap the Backspace key to delete all the characters from the "Name Input Area" in order.

**2. Input the upper-case letter**

If you want to input an upper-case letter, first use the Caps key to switch between the upper-case and lower-case mode. If the Caps key is selected, input the upper-case letter with the virtual keypad. If not, first click or tap the Caps key to ensure it is selected, then input the upper-case letter. All the input letters will be displayed in the "Name Input Area".

**3. Input the lower-case letter**

Refer to the operation specified in the previous step. If the Caps key is not selected, directly input the lower-case letter.

**4. Input numbers or symbols**

If the letter keypad is displayed, you need to click or tap the numeric switchover key to switch to the numeric keypad, and input numbers or symbols with the numeric keypad. All the input letters will be displayed in the "Name Input Area".

**5. Modify or delete the unwanted characters that have been input**

During the name input process, you can modify or delete the unwanted character if necessary. To delete the characters that have been entered, click or tap the



Backspace key in the virtual keypad. To modify the characters that have been input, delete the unwanted characters first and then input the new characters.

You can directly move the cursor to the character to be modified or deleted, delete the desired character or input the new characters after deleting the unwanted character.

#### 6. Confirm the input

After completing the input operation, click or tap "OK".

#### Input a Value

When setting or modifying a parameter, you can input an appropriate value with the numeric keypad.

- Input a value or unit in the keypad using the touch screen.
- You can also rotate the multipurpose knob (1 or 2) to move the cursor and select the desired value and unit. Then press the knob to input the selected value or unit.

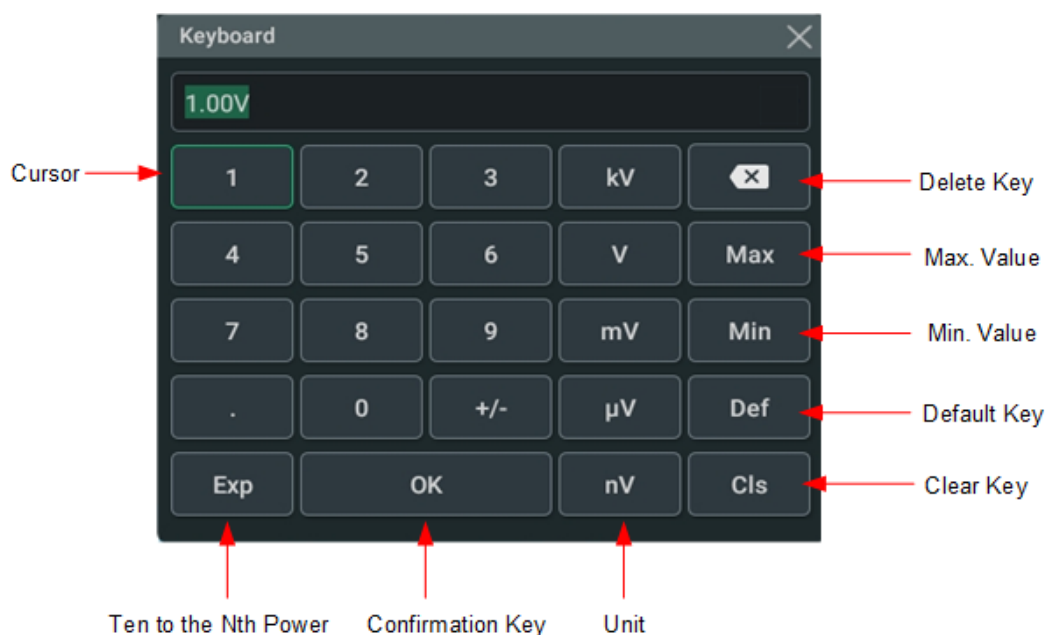

**Figure 4.19 Numeric Keypad**

After you input all the values and select the desired units, the numeric keypad is turned off automatically. This indicates that you have completed parameter setting. Besides, after you have input the values, you can also press "OK" directly to close the numeric keypad. At this time, the unit of the parameter is the default unit. In the numeric keypad, you can perform the following operations:

- Delete the parameter value that has been input;
- Set the parameter value to a maximum or minimum value;

- Set the parameter to a default value.
- Clear the parameter input field.

## 4.7 Using the Security Lock

If necessary, you can lock the instrument to a fixed location by using the security lock (please purchase it by yourself), as shown in the figure below.

The method is as follows: align the lock with the lock hole and plug it into the lock hole vertically, turn the key clockwise to lock the oscilloscope, and then pull the key out.

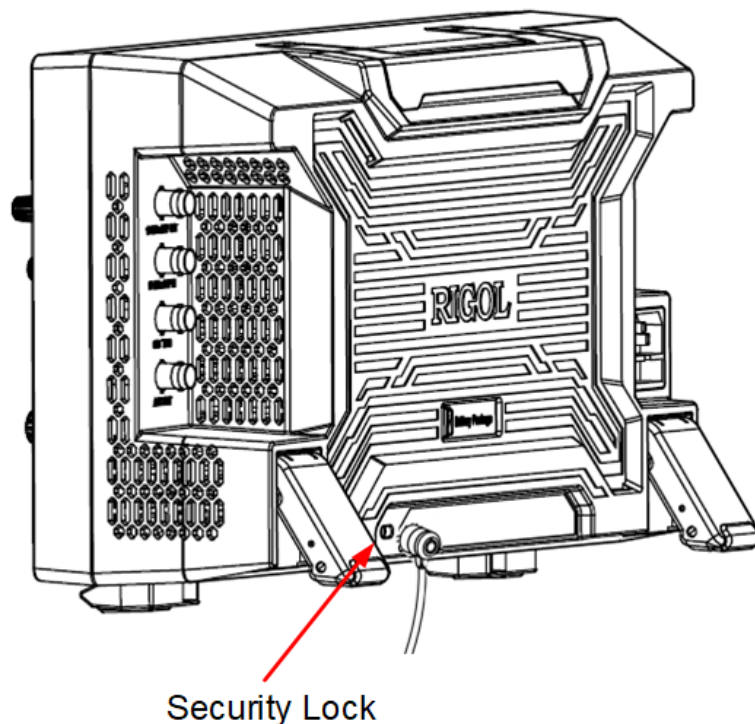

Figure 4.20 To Use the Security Lock



### NOTE

Please do not insert other objects into the security lock hole to avoid damaging the instrument.

## 4.8 Accessing the Built-in Help System

The built-in help system provides instructions for all the front-panel keys and their corresponding menu keys. Click or tap  > **Help** to access the "Help" menu.

After that, you can get its help information by clicking on or tapping the link for the desired item.

## 4.9 Viewing the Option Information and Installation

This series oscilloscope provides multiple options to fulfill your measurement requirements. If you need any of these options, order them according to the Order No. available in "*Appendix A: Options and Accessories*", and then install the options according to this section. Besides, you can also view the options currently installed on the oscilloscope or activate the newly purchased option.

### View the installed option

The instrument is installed with the trial versions of the options before leaving factory. When you power on the instrument for the first time, the trial time is about 2,160 minutes. If your instrument has currently installed the options, perform the following operations to view the name of the installed option and other detailed information about the option.

- Click or tap the function navigation icon  at the lower-left corner of the screen, and then select **Utility** to enter the utility function menu.
- Click or tap **Options** to view the options currently installed.

### Install the option

The option license is a string of fixed characters. The license file should be in specific format, with the filename extension ".lic". After you purchase an option, you will obtain a key (used for obtaining desired the option license code). Then, you can install the option according to the following steps.

#### 1. Obtain an option license

- a. Log in to the **RIGOL** official website (<http://www.rigol.com>), click **SERVICE CENTRE** > **License Activation** to enter the "Registered product license code" interface.
- b. In the software license registration interface, input the correct key, serial number (click or tap  > **Utility** > **About** to obtain the serial number of the instrument), and verification code. Then click **Generate** to obtain the option license. If you need to use the option license file, please click the link to download the file to the root directory of the USB storage device.

#### 2. Install the option

- a. Confirm that the option license file is located in the root directory of the USB storage device, and connect the USB storage device to the oscilloscope properly.

- b. Install the option by sending SCPI commands. For details, please refer to *HDO1000 Programming Guide*.
- c. After installation, a prompt message "Option activated successfully" is displayed. After the option has been installed, it is recommended to restart the instrument.

**TIP**

- Only 1 option license file of one instrument is allowed to be stored in the same USB storage device, but the USB storage device can store the option license file of several different instruments. You are not allowed to modify the licensed filename.
- During the installation process, you are not allowed to power off the instrument or pull out the USB storage device.
- Sending the SCPI commands (:SYSTEM:OPTion:INSTall <license>) to install options is supported. Installing options by inputting the license code manually is not supported.

## 5 Vertical System

This series oscilloscope provides 2 analog input channels (CH1-CH2) for HDO1072/HDO1102/HDO1202 and 4 analog input channels (CH1-CH4) for HDO1074/HDO1104/HDO1204, and each channel is equipped with an independent vertical control system. The setting methods for their vertical systems are the same. This chapter takes CH1 of a four-channel model as an example to introduce the setting method for the vertical system.

When a channel is selected, click or tap the channel status label at the bottom of the screen. Then the menu as shown in the figure below is displayed.

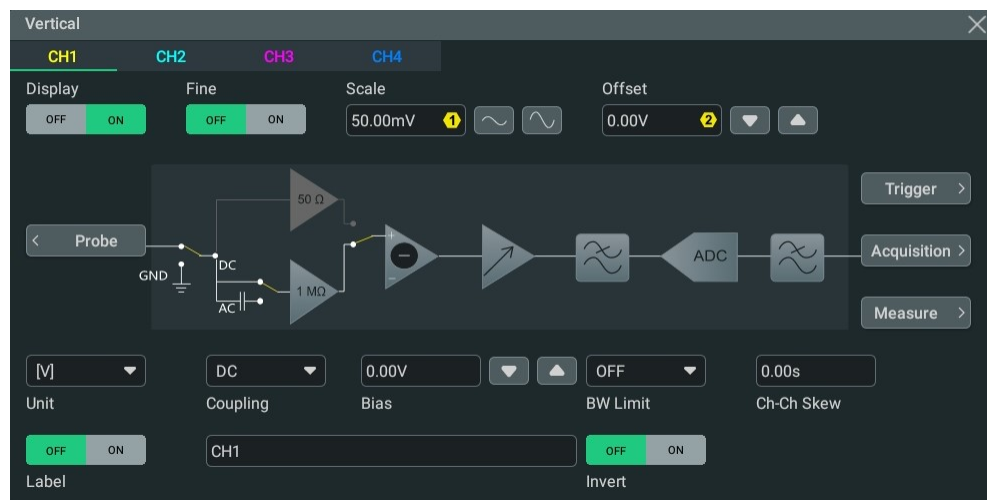

Figure 5.1 Vertical Menu

### 5.1 To Enable or Disable the Analog Channel

#### Enable the analog channel

When a signal is connected to CH1, you can enable the channel by the following methods.

- Click or tap the channel status label at the bottom of the screen to enable the channel.
- Press the front-panel key 1 to enable the channel, and the backlight of this key is illuminated.
- In *Vertical System* menu, select the CH1 tab. Click or tap the **Display** on/off switch to turn CH1 on or off.

When CH1 is activated, its status label at the bottom of the screen is as shown in the figure below.



The information displayed in the channel status label is related to the current channel setting (irrelevant with the on/off status of the channel). After the channel is turned on, you can modify the parameters such as the vertical scale, horizontal time base, trigger mode, and trigger level according to the input signal for easy observation and measurement of the waveform.

When CH1 is enabled but not activated, its status label is as shown in the following figure.

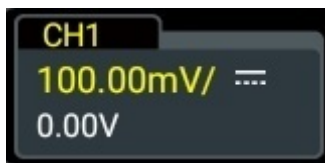

Click or tap the channel status label at the bottom of the screen or press the front-panel key 1 to activate CH1. You can also select the **CH1** tab in Vertical menu to activate it.

### Disable the analog channel

You can disable the analog channel by the following methods.

- If CH1 has been enabled and activated, you can press 1 on the front panel to disable it directly. You can also click or tap the channel status label at the bottom of the screen to open the Vertical menu and then click or tap the label again to disable the channel.
- If CH1 has been enabled but not activated, first activate the channel. Then press the front-panel key 1 or use the channel status label to disable CH1.
- In *Vertical System* menu, set **Display** to OFF to disable CH1.
- Also, you can slide down the channel label to disable the channel.

If CH1 is disabled, its status label is as shown in the figure below.

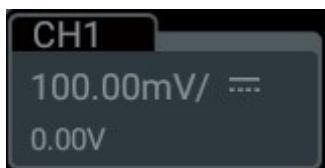

## 5.2 To Adjust the Vertical Scale

Vertical scale indicates the voltage value per grid in the vertical axis of the screen. It is often expressed in V/div. Adjusting the vertical scale increases or decreases the display amplitude of the waveform. The scale information of the channel status label at the bottom of the screen would change accordingly.

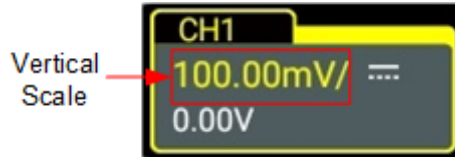

The adjustable range of the vertical scale is related to the current probe ratio. By default, the probe ratio is 1X. In this case, the adjustable range of the vertical scale is 500  $\mu$ V/div to 10 V/div.

When CH1 is turned on and activated, you can adjust the vertical scale with the following methods:

- Rotate the **Vertical SCALE** knob to adjust the vertical scale (clockwise to reduce the scale and counterclockwise to increase).
- Enable the touch screen function, and then adjust the vertical scale with the pinch & stretch gesture on the touch screen. For details, refer to descriptions in *Pinch&Stretch*.
- In the **Vertical** menu, click or tap the icon at the right side of the input field of Scale to increase or decrease the scale value or use the corresponding multipurpose knob on the front panel to set the value. You can also click or tap the input field to input a specific value with the displayed numeric keypad.

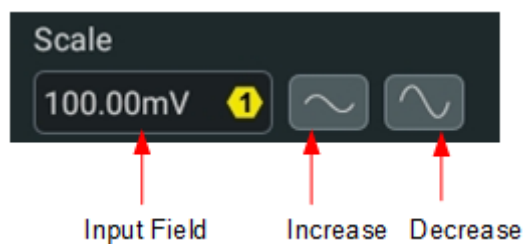

In the **Vertical** menu, click or tap the **Fine** on/off switch to toggle between **ON** (fine adjustment) and **OFF** (coarse adjustment). The default setting is OFF. You can also

press the **Vertical SCALE** knob to toggle between "coarse adjustment" and "fine adjustment".

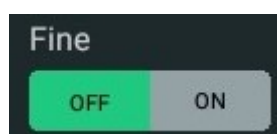

- **Fine adjustment:** Use the icons at the right side of **Scale** or rotate the knob to further adjust the vertical scale within a relatively smaller range to improve vertical resolution. If the amplitude of the input waveform is a little bit greater than the full scale under the current scale but a little bit lower if the next scale is used, fine adjustment can be used to improve the amplitude of waveform display to view signal details.
- **Coarse adjustment:** Use the icons at the right side of **Scale** or rotate the knob to adjust the vertical scale in a 1-2-5 step sequence, i.e. 500  $\mu\text{V}/\text{div}$ , 1  $\text{mV}/\text{div}$ , 2  $\text{mV}/\text{div}$ , 5  $\text{mV}/\text{div}$ , 10  $\text{mV}/\text{div}$ ...10  $\text{V}/\text{div}$ .

## 5.3 To Adjust the Vertical Offset

Vertical offset indicates the offset of the signal ground level position of the waveform from the vertical center of the display. Its unit is consistent with the currently selected amplitude unit (refer to "*To Specify the Amplitude Unit*"). Adjusting the vertical offset moves the corresponding channel's waveform up and down. The vertical offset information (as shown in the following figure) in the channel status label at the bottom of the screen will change accordingly.

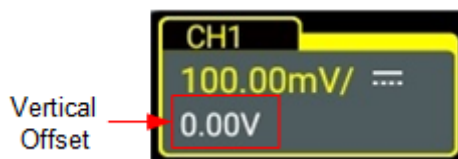

The adjustable range of the vertical offset is related to the current probe ratio and vertical scale.

When CH1 is turned on and activated, you can adjust the vertical offset with the following methods:

- Rotate the **Vertical POSITION** knob at the right section of the front panel to adjust the vertical offset within the adjustable range. Rotate this knob clockwise to increase the vertical offset or rotate it counterclockwise to reduce the vertical offset. Pressing the knob can quickly reset the vertical offset (set the vertical offset to 0).
- Enable the touch screen function, and then adjust the vertical offset with the drag gesture. For details, refer to "*Drag*".
- In **Vertical** menu, click or tap the Up and Down arrow icon at the right side of the input field of **Offset** to increase or decrease the offset value or use the corresponding multipurpose knob to set the value. You can also click or tap the input field to input a specific value with the displayed numeric keypad.



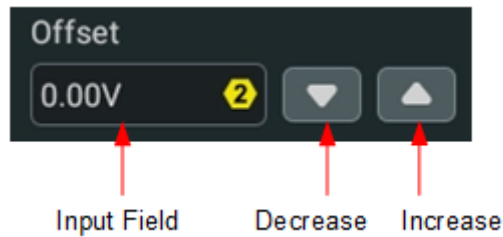

## 5.4 To Specify Channel Coupling

You can remove unwanted signals by setting the coupling mode. For example, the signal under test is a square waveform with DC offset.

Click or tap the channel status label at the bottom of the screen. Then the **Vertical** menu is displayed. Click or tap the **Coupling** drop-down button to select the coupling mode.

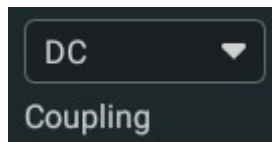

- When the coupling mode is "DC", the DC and AC components of the signal under test can both pass the channel.
- When the coupling mode is "AC", the DC components of the signal under test are blocked.
- When the coupling mode is "GND", the DC and AC components of the signal under test are blocked.

After selecting the coupling mode, the currently selected coupling mode is displayed in the channel status label at the bottom of the screen, as shown in the figure below.

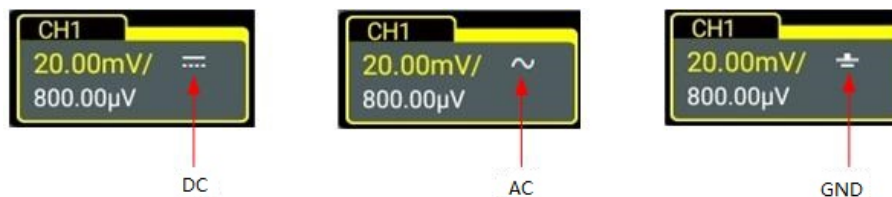

### TIP

When the input impedance is set to "50  $\Omega$ ", the channel coupling is set to DC coupling by force. The **Coupling** menu is grayed out and cannot be modified.

## 5.5 To Specify Bandwidth Limit

This oscilloscope supports the bandwidth limit function. Setting the bandwidth limit can remove the noises in the displayed waveforms. For example, the signal under test is a pulse with high frequency oscillation.

- When the bandwidth limit is turned off, the high frequency components of the signal under test can pass the channel.
- When the bandwidth limit is turned on, the high frequency components found in the signal under test that are greater than the limit are attenuated. HDO1000 series oscilloscope supports 20 MHz bandwidth limit.

Click or tap the channel status label at the bottom of the screen. Then the **Vertical** menu is displayed. Click or tap the **BW Limit** drop-down button to select the specified bandwidth. When the bandwidth limit is enabled, the character "**Bw**" will be displayed in the channel status label at the bottom of the screen, as shown in the figure below.



#### TIP

Bandwidth limit can not only reduce the noise, but also can attenuate or eliminate the high frequency components of the signal.

## 5.6 To Specify Input Impedance

This series oscilloscope provides 1 MΩ input impedance mode. In this mode, the input impedance of the oscilloscope is very high, and the current flowed from the circuit under test can be ignored.

## 5.7 To Invert a Waveform

Click or tap the channel status label at the bottom of the screen, and then the **Vertical** menu is displayed. Then click or tap the **Invert** on/off switch to enable or disable the waveform invert function.

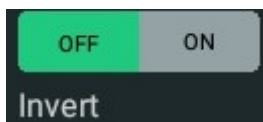

When "ON" is selected, the channel label is as shown in the figure below.

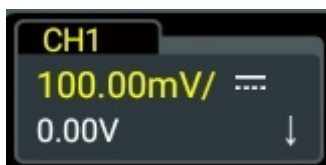

When the Invert function is disabled, the waveform is displayed normally; when enabled, the voltage values of the displayed waveform are inverted, as shown in the figure below. Inverting a waveform also changes the result of math function, waveform measurement, etc.

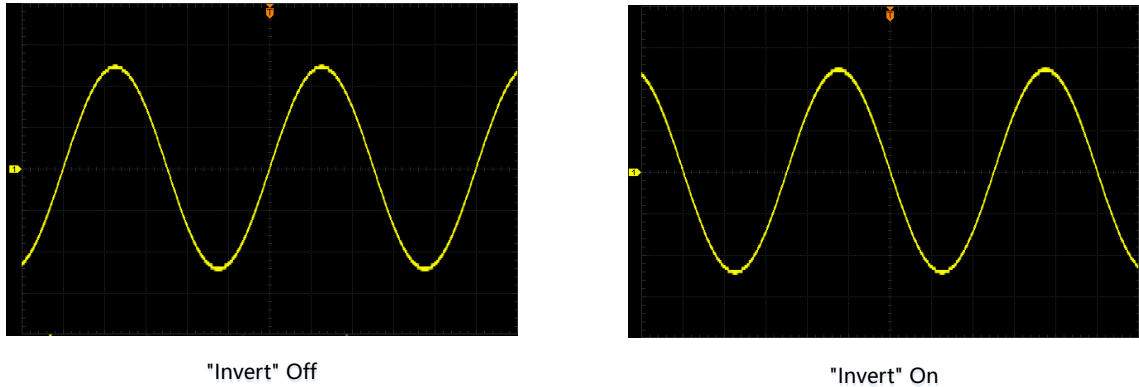

Figure 5.2 Waveform Invert On/Off



#### TIP

When the Invert function is turned on, the trigger (e.g. Edge trigger, Pulse trigger, or Slope trigger) edge or polarity will be changed.

## 5.8 To Set Probe

The analog channel of this oscilloscope supports passive probes. For detailed technical information of the probes, please refer to the corresponding Probe User Guide.

Click or tap the channel status label at the bottom of the screen. Then the menu **Vertical** is displayed. Then click or tap **Probe** to enter the **Probe** setting menu, as shown in the figure below.

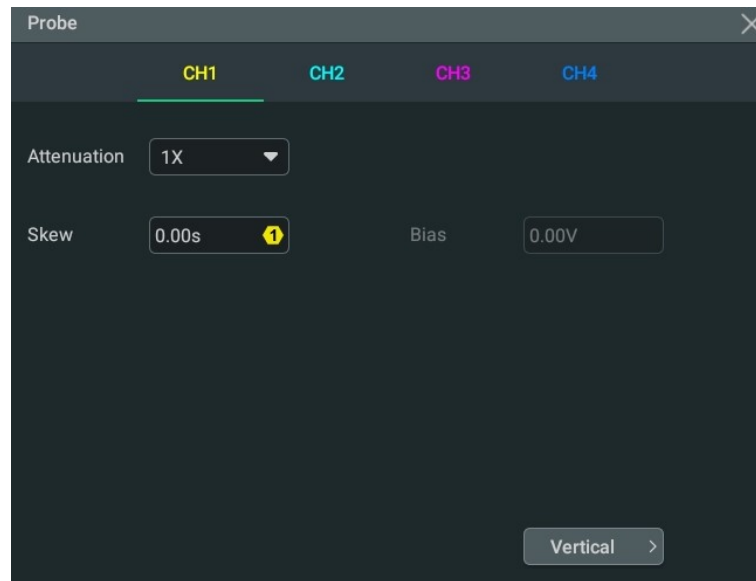

Figure 5.3 Probe Setting Menu

### Probe Ratio

The oscilloscope allows you to set the probe attenuation manually. To obtain the accurate measurement results, you must set the probe ratio properly. By default, the probe ratio is 1X.

The probe ratio values available are as shown in the following table.

Table 5.1 Probe Ratio

Menu	Attenuation (display amplitude of the signal: actual amplitude of the signal)
0.001X	0.001:1
0.002X	0.002:1
0.005X	0.005:1
0.01X	0.01:1
0.02X	0.02:1
0.05X	0.05:1
0.1X	0.1:1
0.2X	0.2:1
0.5X	0.5:1
1X (default)	1:1

Menu	Attenuation (display amplitude of the signal: actual amplitude of the signal)
2X	2:1
5X	5:1
10X	10:1
20X	20:1
50X	50:1
100X	100:1
200X	200:1
500X	500:1
1000X	1000:1
2000X	2000:1
5000X	5000:1
10000X	10000:1
20000X	20000:1
50000X	50000:1



### TIP

The oscilloscope auto-recognizes certain probes with a fixed attenuation ratio. After that, the probe ratio will also be auto recognized to save you from configuring it manually.

### Skew

The difference in the delays between the probes, known as skew, can cause great cable-delay errors in measurement results. To eliminate this problem, this series oscilloscope provides the deskew function. Click or tap the **Skew** input field to set the delay time with the pop-up numeric keypad. You can also use the corresponding numeric keypad to set the value. The value ranges from -100.00 ns to 100.00 ns, and the default is 0.00 s.

### Go Back to the Vertical Menu

In the **Probe** setting menu, click or tap **Vertical** to go back to the **Vertical** menu.

## 5.9 To Specify the Amplitude Unit

Click or tap the channel status label at the bottom of the screen, and then the **Vertical** menu is displayed. Click or tap the **Unit** drop-down button to select W, A, V, or U. The default unit is V.



Changing the amplitude unit also changes the units of the functions related to the channel accordingly.

## 5.10 To Adjust Bias

When you use an oscilloscope to make actual measurements, a small offset that arises from the temperature drift of the component or external environment disturbance may occur on the zero-cross voltage of the channel, which will affect the measurement results of the vertical parameters. This series oscilloscope allows you to set an offset calibration voltage for calibrating the zero point of the corresponding channel, so as to improve the accuracy of the measurement results.

In "Vertical" menu, click or tap the Up/Down arrow icon at the right side of the input field of **Bias** to increase/decrease the bias value or use the corresponding multipurpose knob to set the value. You can also click or tap the input field to input a specific value with the displayed numeric keypad.



Value Input Field Decrease Increase

The range of bias is related to the input impedance and the vertical scale.



### TIP

If the zero-cross voltage of the channel has a larger amplitude offset that exceeds the adjustable null range, please perform self-calibration for the instrument to ensure the measurement accuracy. For details, please refer to [SelfCal](#).

## 5.11 To Specify the Skew

When using an oscilloscope for actual measurement, the transmission delay of the probe cable may bring relatively greater errors (zero offset). This series oscilloscope allows you to set a delay time for calibrating the zero offset of the corresponding

channel. Zero offset is defined as the offset of the crossing point of the waveform and trigger level line relative to trigger position, as shown in the figure below.

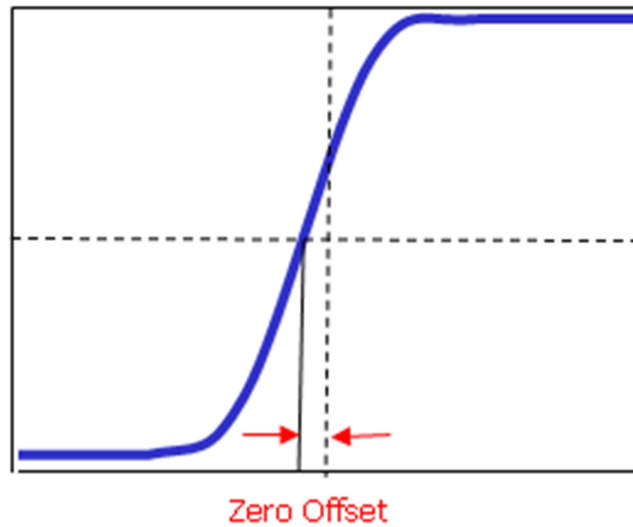
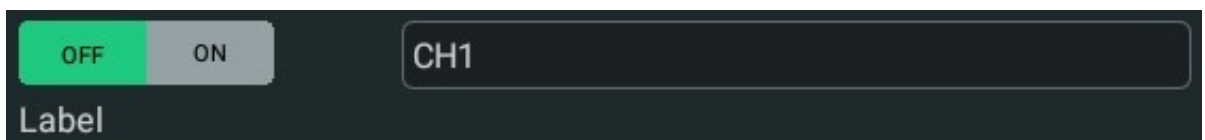

Figure 5.4 Zero Offset

In the "Vertical" menu, click or tap the **Ch-Ch Skew** input field to set the channel-to-channel skew time. The available range is from -100 ns to 100 ns, and the default is 0.00 s.

## 5.12 To Turn the Channel Label Display On/Off

The instrument uses the channel number to mark the corresponding channel by default. For ease of use, you can also set a label for each channel. For example, **CH1**. Click or tap the channel status label at the bottom of the screen. Then the **Vertical** menu is displayed. Click or tap the **Label** on/off switch to turn the label display on or off. You can also click or tap the label input field to input a specific name for the channel label with the pop-up keypad.



For how to use the keypad, please refer to descriptions in *Parameter Setting Method*.

## 6 Horizontal System

You can access the **Horizontal** menu in the following ways.

- Press the front-panel  key to enter the **Horizontal** menu.
- Click or tap the channel status label at the bottom of the screen. Then the **Vertical** menu is displayed. Click or tap the **Acquisition** button to enter the **Horizontal** menu.
- Click or tap the horizontal time base label ("H" icon), acquisition label ("A" icon), or horizontal position label ("D" icon) at the top of the screen to enter the **Horizontal** menu.

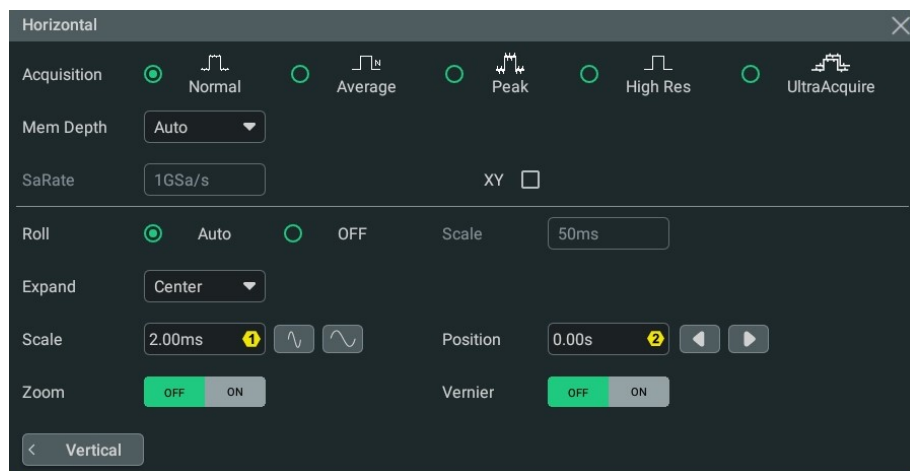
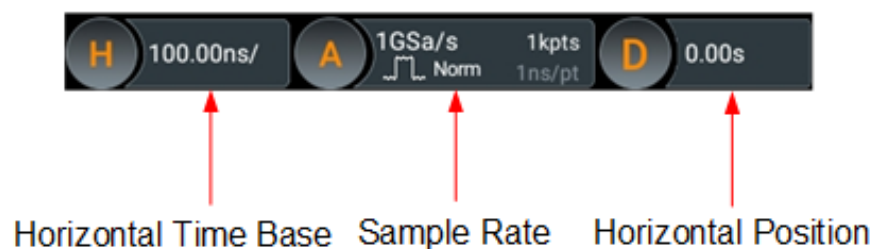

Figure 6.1 Horizontal Menu

### 6.1 To Adjust the Horizontal Time Base

Horizontal time base, also called the horizontal scale, refers to the time of each grid in the horizontal direction of the screen. It is usually expressed in s/div. The range of the horizontal time base is from 2.00 ns/div to 1.00 ks/div.

While you change the horizontal time base, the displayed waveforms of all channels are expanded or compressed horizontally relative to the selected time reference





(*Horizontal Expansion Reference*). The horizontal time base in the horizontal time base label ("H" icon) will change accordingly, as shown in the figure below.

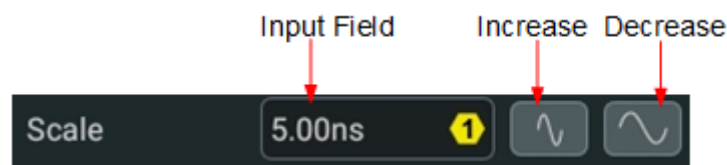

You can adjust the horizontal time base with the following methods.

- Rotate the front-panel **Horizontal**  **SCALE** knob to adjust the horizontal time base (clockwise to reduce the scale and counterclockwise to increase).
- Enable the touch screen function, and then adjust the horizontal time base with the Pinch&Stretch gesture. For details, refer to *Pinch&Stretch*.
- In the **Horizontal** menu, click or tap the icon at the right side of the input field of **Scale** to increase or decrease the horizontal time base or use the corresponding multipurpose knob to set the value. You can also click or tap the input field to input a specific value with the displayed numeric keypad.



In the **Horizontal** menu, you can click or tap the **Vernier** on/off switch to toggle between **ON** (fine adjustment) and **OFF** (coarse adjustment). You can also press the front-panel **Horizontal**  **SCALE** knob to toggle between "coarse adjustment" and "fine adjustment".

- **Coarse adjustment:** Click or tap the icon at the right side of the input field of **Scale** to adjust the horizontal time base of the waveforms of all channels in a 1-2-5 step sequence within the adjustable range.
- **Fine adjustment:** Click or tap the icon at the right side of the input field of **Scale** to adjust the horizontal time base of the waveforms of all channels at a smaller step within the adjustable range.

## 6.2 To Adjust the Horizontal Position

Horizontal position, also called trigger position, refers to the trigger point position of the waveforms of all channels in the horizontal direction relative to the center of the display. When the waveform trigger point is at the left (right) side of the center, the horizontal position is a positive (negative) value.

Changing the horizontal position moves the waveform trigger points and the displayed waveforms of all channels horizontally. The horizontal position displayed in

the horizontal position label ("D" icon) changes accordingly, as shown in the figure below.



You can adjust the horizontal position with the following methods.

- Rotate the **Horizontal POSITION** knob at the right section of the front panel to adjust the horizontal position within the adjustable range. Rotate this knob clockwise to reduce the horizontal position or counterclockwise to increase the horizontal position. Pressing the knob can quickly reset the horizontal position (set the horizontal position to 0).
- Enable the touch screen function, and then adjust the horizontal position with the drag gesture. For details, refer to *Drag*.
- In the "Horizontal" menu, use the corresponding multipurpose knob to set the horizontal position or use the icons at the right side of the input field of **Position** to increase or decrease the value, as shown in the figure below. You can also click or tap the **Position** input field to input a specific value with the pop-up numeric keypad.

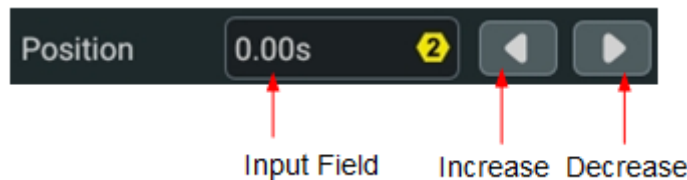

## 6.3 Zoom Mode (Delayed Sweep)

Zoom (delayed sweep mode) can be used to horizontally expand a length of waveform to view waveform details. In the **Horizontal** menu, click or tap the **Zoom** on/off switch to enable or disable the delayed sweep function. When it is enabled, you can set the scale and offset for the delayed sweep.

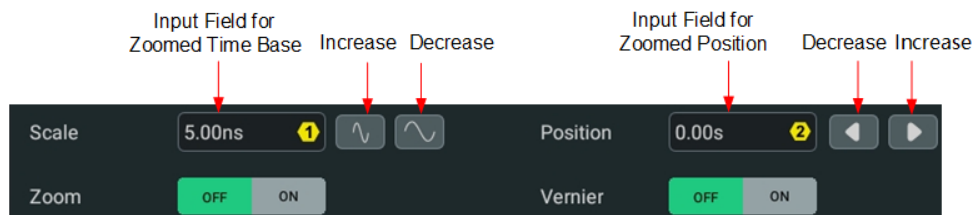

- **Scale:** Rotate the corresponding multipurpose knob or use the icons at the right of the **Scale** input field to increase or decrease the time base for the Zoom

window. You can also click or tap the input field to input the specific value directly via the pop-up numeric keypad.

- **Position:** Rotate the corresponding multipurpose knob or use the icons at the right of the **Position** input field to increase or decrease the position for the Zoom window. You can also click or tap the input field to input the specific value directly via the pop-up numeric keypad.

In Zoom mode, the display divides in half, as shown in the figure below.

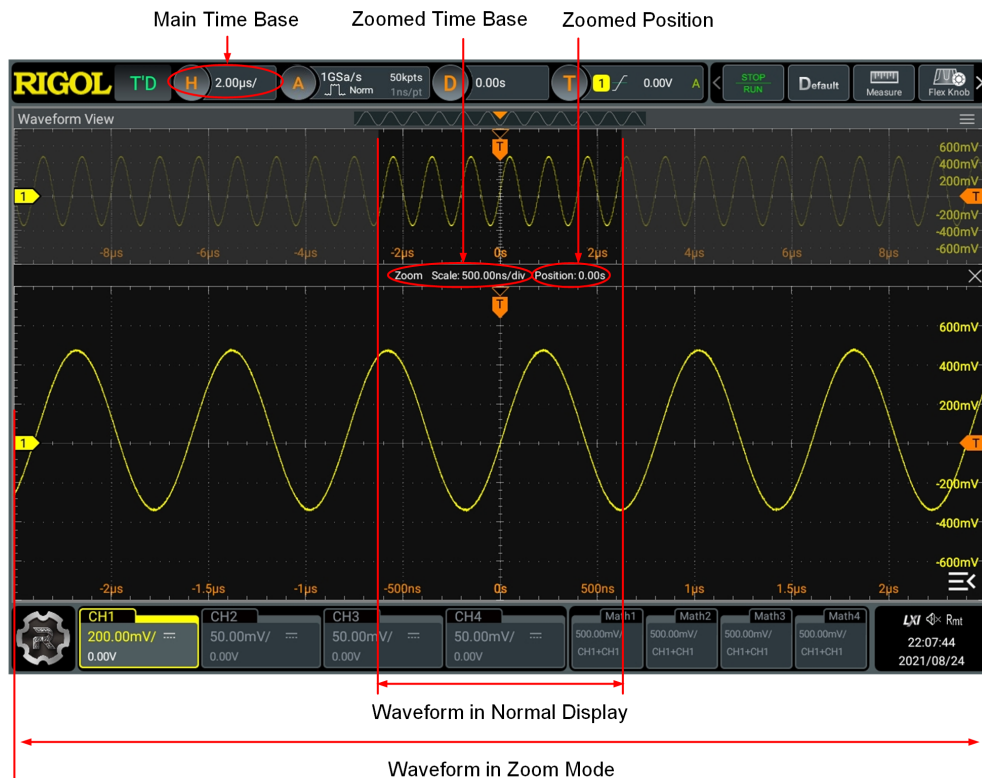

**Figure 6.2 Zoom Mode**

- **Waveform in normal display:**  
The upper portion of the display that is not ghosted shows the normal display of the waveform. Its horizontal time base (called the main time base) is indicated in the label at the upper-left corner of the display. You can move the area left and right by adjusting the horizontal position and increase or decrease the size of the area by adjusting the horizontal scale.
- **Waveform in Zoom mode:**  
The lower portion shows the horizontally expanded version of the normal waveform display. Its horizontal time base (called the zoomed time base) is displayed in the middle. Compared with the main time base, the zoomed time base has higher resolution.



**TIP**

The zoomed time base should be smaller than or equal to the main time base.

## 7 Acquisition System

The "Horizontal" menu allows you to configure the instrument's acquisition system.

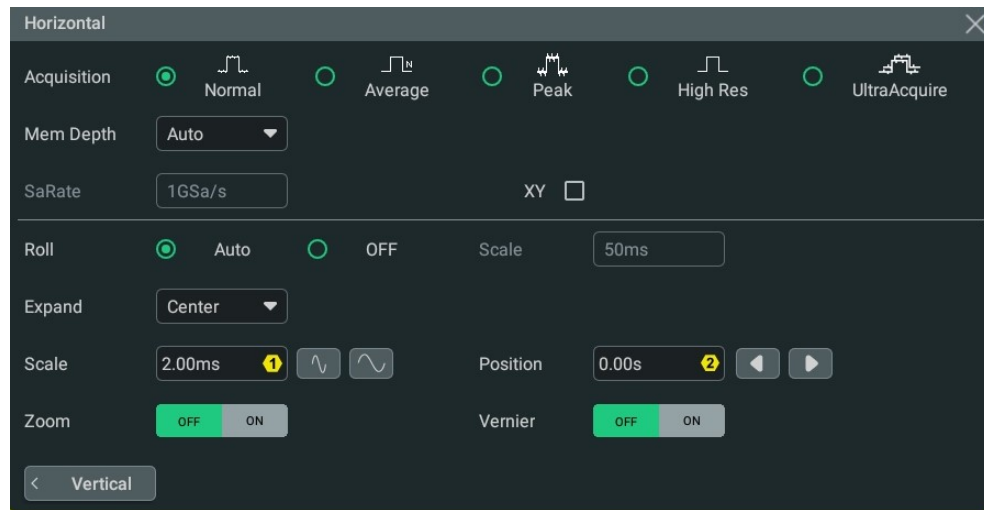

Figure 7.1 Horizontal Menu

### 7.1 Acquisition Mode

The acquisition mode is used to determine how the waveform points are calculated from the sample points. In the **Horizontal** menu, click or tap the desired acquisition mode for the **Acquisition** item. This oscilloscope provides five acquisition modes: Normal (default), Average, Peak, High Res, and UltraAcquire. The selected acquisition mode is indicated in the acquisition label ("A" icon) at the top of the screen.



#### Normal

In Normal acquisition mode, the oscilloscope samples the signal at a fixed time interval to rebuild the waveform. This mode yields the best display for most waveforms.

#### Average

In this mode, the oscilloscope averages the waveforms from multiple acquisitions to reduce the random noise of the input signal and increase the vertical resolution. A greater number of averages lowers the noise and increases the vertical resolution. On the other hand, the higher the number of averages, the slower the displayed waveform responds to waveform changes.

When you select "Average" mode, click or tap the **Averages** input field to set it with the pop-up numeric keypad or use the corresponding multipurpose knob to set the value. Its range is from 2 (default) to 65536.

**TIP**

The number of averages must be the Nth power of 2. When it is not in N power-of-2 increments, a prompt message "Truncation average error" is displayed. At this time, a value that is smaller than the one you input and the closest to N power-of-2 increments will be input automatically.

**Peak**

In this mode, the oscilloscope acquires the maximum and minimum values of the signal within the acquisition interval to get the signal envelope or capture narrow pulses that might be lost. This mode prevents signal aliasing at the expense of exaggerating the noise.

In this mode, the minimum pulse width detected is the sample period.

**High Resolution**

This mode uses a kind of ultra-sample technique to average sequential sample points to reduce the random noise on the input signal and generate much smoother waveforms on the screen. This is generally used when the sample rate of the digitizer is higher than the storage rate in acquisition memory.

When you select "High Res" mode, click or tap the **bits** drop-down button to select 14 (default) or 16. The bandwidth of the selected bit is displayed behind the box.

**TIP**

- The averaging modes of the "Average" and "High Res" are different. The former uses "Multi-sample Average" and the latter uses "Single Sample Average".
- In "High Res" mode, the oscilloscope improves the measurement accuracy at the cost of bandwidth. Each time the sample rate changes, the current bandwidth is indicated at the right side of **bits** in the menu.

**UltraAcquire**

UltraAcquire mode is one of the fast acquisition modes. It divides the oscilloscope's memory into segments and fills a memory segment for each individual trigger event. It provides a much higher waveform capture rate and helps minimize the dead time between trigger events.

When you select "UltraAcquire" mode, click or tap **Max Frames** input field to set the maximum number of frames and **Timeout** input field to set the timeout. When the number of the frames reaches the maximum or the sampling time reaches the timeout, the oscilloscope stops sampling and plots the waveform. Click or tap the **Display mode** drop-down button to select the display mode of the acquired data.

- **Adjacent:** Waveform segments are shown in an adjacent way with each segment shown next to the previous segment. A maximum of 100 frames can be displayed on the screen at a time in this mode.
- **Overlay:** All the captured waveform segments are overwritten to display as one single segment of the waveform. A maximum of 100 frames can be displayed on the screen at a time in this mode.
- **Waterfall:** It displays the captured waveform segments in a cascaded display order. A maximum of 100 frames can be displayed on the screen at a time in this mode.
- **Perspective:** The waveform segments are displayed in the ladder-like form, with each segment being arranged above another with a certain perspective (angle), moving up like a rising slope. A maximum of 100 frames can be displayed on the screen at a time in this mode.
- **Mosaic:** The whole waveform view is divided into several blocks, and each waveform segment is displayed in each block in sequence. A maximum of 80 frames can be displayed on the screen at a time in this mode.

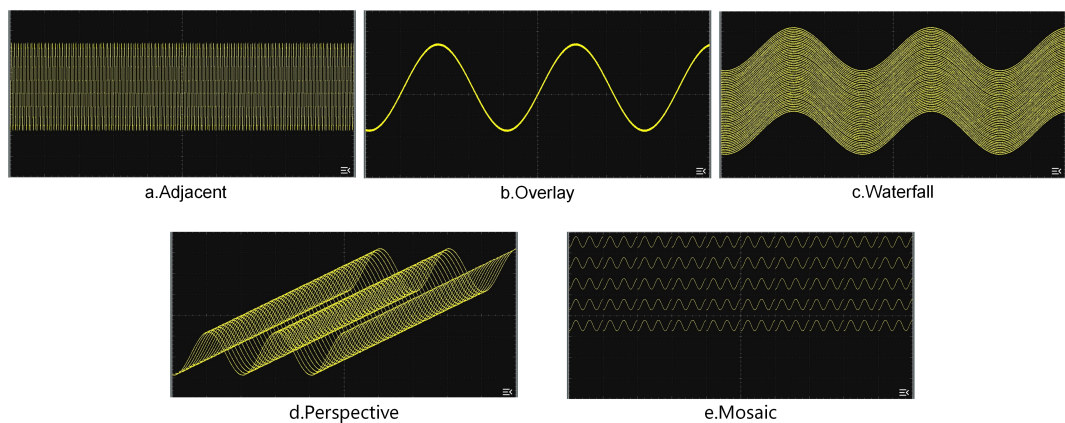

**Figure 7.2 Display Modes**



**TIP**

- The UltraAcquire mode is not available when any of the following functions is enabled: cursors, decoding, Search, Zoom, Pass/Fail test, waveform recording, reference waveform, XY. To switch to the UltraAcquire mode, please ensure that all of those functions are disabled.
- In UltraAcquire mode, the functions mentioned above are disabled.

## 7.2 Sampling Mode

This oscilloscope only supports the real-time sampling mode. In this mode, the oscilloscope produces the waveform display from samples collected during one trigger event. The maximum real-time sample rate of this series is 2 GSa/s. The current sample rate is displayed in the acquisition label at the top of the screen.

By default, the operating status label at the left top of the screen is illuminated green, indicating that the instrument is in real-time sampling, and the **STOP/RUN** button in the toolbar is in green. Click or tap the **STOP/RUN** button or press the front-panel



key to stop sampling. At this time, the operating status label shows "STOP" in

red, the **STOP/RUN** button turns red. Also, the backlight of the front-panel  key turns red. The oscilloscope will maintain its last captured graph. You can still pan or zoom the waveforms by using the horizontal/vertical controls.

## 7.3 Sample Rate

Sampling is the process of converting an analog signal into the digital signal at a specified time interval and then storing them sequentially in acquisition memory. The sample rate is the reciprocal of the time interval.

In **Horizontal** menu, the "SaRate" item shows the current sample rate. The current sample rate is also indicated in the acquisition label ("A" icon) at the top of the screen, as shown in the figure below.

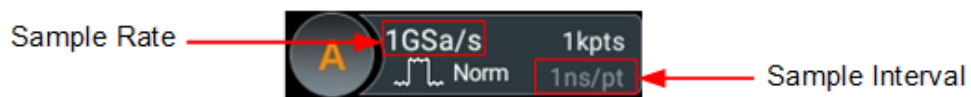

The sample rate of the analog channel is related to the instrument model and the current channel mode. For two-channel models (HDO1072, HDO1102, and HDO1202), the oscilloscope provides up to 2 GSa/s real-time sample rate in single channel mode and 1 GSa/s real-time sample rate in all channels mode. For four-channel models (HDO1074, HDO1104, and HDO1204), the oscilloscope provides up to 2 GSa/s real-time sample rate in single channel mode, 1 GSa/s real-time sample rate in half channels mode, and 500 MSa/s real-time sample rate in all channels mode.

- **Single channel mode:** If any one of the channels is enabled, it is called single channel mode.
- **Half channels mode:** For four-channel models, if two of the channels are enabled, it is called half channels mode.
- **All channels mode:** For two-channels models, if all two channels are enabled, it is called all channels mode; for four-channel models, if any three channels or all four channels are enabled, it is called all channels mode.

A sample rate that is too low might have the following effects on the waveform:

- **Waveform Distortion:** When the sample rate is too low, some waveform details are lost, and the sample waveform displayed is rather different from the actual waveform of the signal.



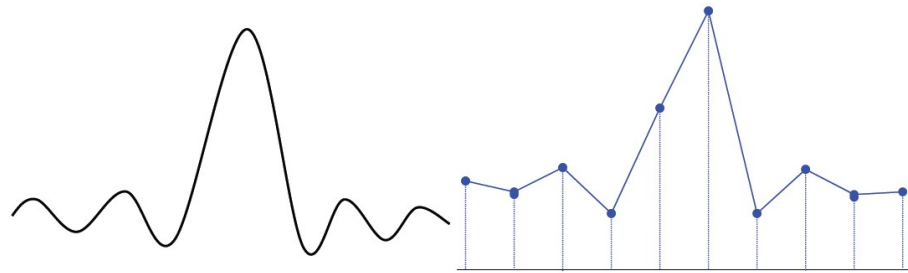

- **Waveform Aliasing:** Aliasing occurs when the sample rate is twice lower than the actual signal frequency (Nyquist Frequency). The frequency of the waveform reconstructed from the sample data is smaller than the actual signal frequency.



- **Waveform Leakage:** When the sample rate is too low, the waveform reconstructed from the sample data does not reflect all the actual signal information.

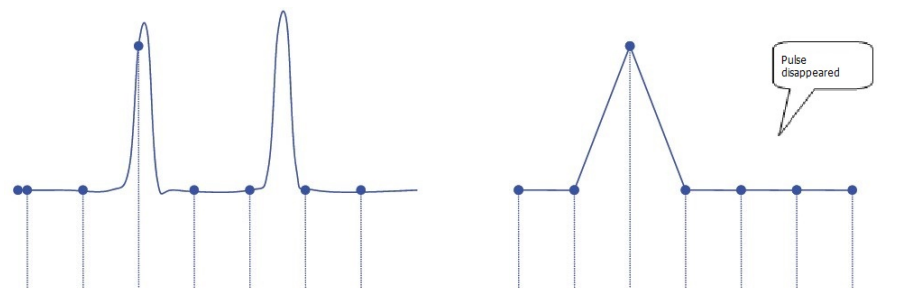

## 7.4 Memory Depth

Memory depth refers to the number of points that the oscilloscope can store in a single trigger acquisition. It reflects the storage capability of the acquisition memory. HDO1000 series oscilloscope provides up to 50 Mpts memory depth (100 Mpts optional).

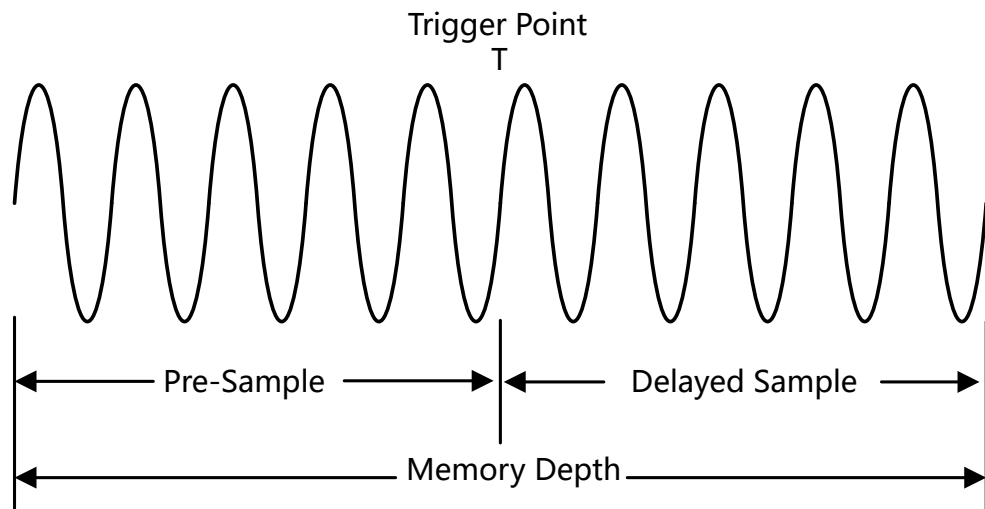

**Figure 7.3 Memory Depth**

The following equation shows the relations among memory depth, sample rate, and horizontal time base:

$$MDepth = SRate \times TScale \times HDivs$$

- **Mdepth** indicates the memory depth. The unit is pts.
- **SRate** indicates the sample rate. The unit is Sa/s.
- **TScale** indicates the horizontal time base. The unit is s/div.
- **HDivs** indicates the number of grids in the horizontal direction. The unit is div.

Therefore, under the same horizontal time base, a higher memory depth can ensure a higher sample rate.

In **Horizontal** menu, click or tap the **Mem Depth** drop-down button to select the memory depth. The default setting is "10k". The selected memory depth value is displayed in the acquisition label ("A" icon) at the top of the screen.



- When only one of the channels is enabled, the memory depths available include Auto, 1 kpts, 10 kpts, 100 kpts, 1 Mpts, 10 Mpts, 25 Mpts, 50 Mpts, and 100 Mpts (optional).
- When two of the channels are enabled, the memory depths available include Auto, 1 kpts, 10 kpts, 100 kpts, 1 Mpts, 10 Mpts, 25 Mpts, and 50 Mpts (optional).

- When three channels or all four channels are enabled (only available for four-channel models), the memory depths available include Auto, 1 kpts, 10 kpts, 100 kpts, 1 Mpts, 10 Mpts, and 25 Mpts (optional).

**TIP**

In "Auto" mode, the oscilloscope selects the memory depth automatically according to the current sample rate.

## 7.5 Horizontal Expansion Reference

This function allows you to set the position that the waveform on the display is referenced to when it is horizontally expanded or compressed when the horizontal time base is adjusted. In the **Horizontal** menu, click or tap the **Expand** drop-down button to select the reference position. Available options include Center (default), Left, Right, Trigger, and User.

- **Center:** when the horizontal time base is modified, the waveform will be expanded or compressed horizontally relative to the center of the display.
- **Left:** when the horizontal time base is modified, the waveform will be expanded or compressed horizontally relative to the leftmost position of the display.
- **Right:** when the horizontal time base is modified, the waveform will be expanded or compressed horizontally relative to the rightmost position of the display.
- **Trigger:** when the horizontal time base is modified, the waveform will be expanded or compressed horizontally relative to the trigger point.
- **User:** when the horizontal time base is modified, the waveform displayed will be expanded or compressed horizontally relative to the user-defined reference position.

When you select "User", click or tap the **Expand User** input field and set the value with the displayed numeric keypad. Its range is from -500 to 500, and the default is 0.

## 7.6 XY Mode

By default, this series oscilloscope uses the YT mode for waveform display window. In YT mode, Y-axis indicates the Voltage and X-axis indicates the Time. Besides, it also supports the XY display in which both X-axis and Y-axis indicate voltage. The XY mode converts the oscilloscope from a volts-versus-time display to a volts-versus-volts display using two input channels.

### Enable the XY Mode

You can enable the XY display mode in the following ways:

- Click or tap the **Windows** button in the function navigation menu or in the toolbar to enter the **Add Window** menu. In the Diagram menu, click or tap **XY > Add** to enable the XY display mode.
- Click or tap the **XY** button in the function navigation menu or in the toolbar to enable the XY display mode.
- In the "Horizontal" menu, tick **XY** to enable the XY mode.

### Configure the XY Mode

Click or tap  at the upper-right corner of the XY display window to enter the XY configuration menu.

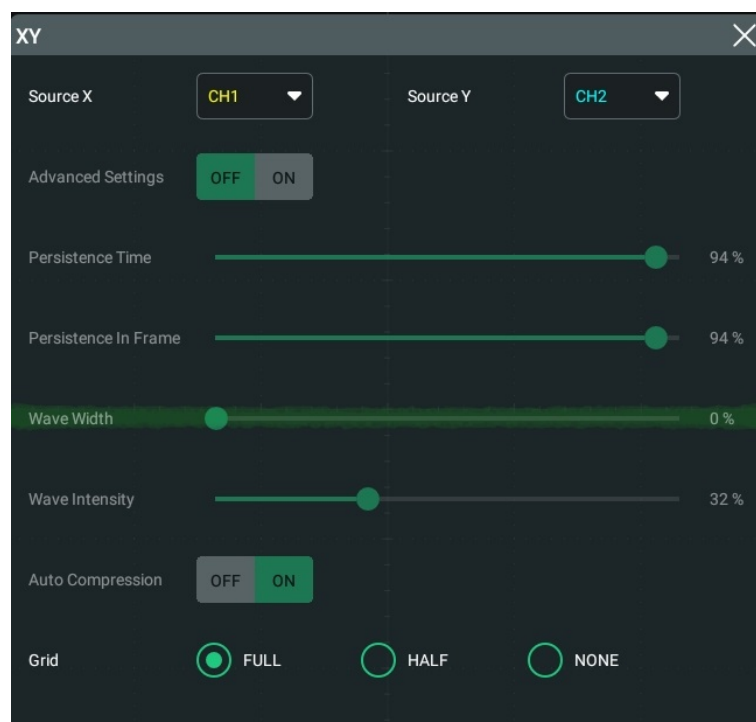

**Figure 7.4 XY Menu**

- **Source:** Click or tap the drop-down button of "Source X" to select the source channel of the X-axis in the XY window. Click or tap the drop-down button of "Source Y" to select the source channel of the Y-axis in the XY window.

In the *Add Window* menu, you can also configure Source Z. Source Z, as the Z-axis input in the XY display mode, is used to control whether to display the X-Y waveforms in the XY display mode. This function is called "blanking".

- When "None" is selected for "Source Z", the blanking function is disabled, and you can only see the X-Y waveforms.
- When you select "CH1-CH4" for "Source Z", the blanking function is enabled. The Z-axis input from the external connector determines whether to display the X-Y waveforms. When Z is high (the input level is greater than

0 V), the X-Y waveforms are displayed; when Z is low (the input level is smaller than 0 V), the waveforms are hidden.

- **Grid:** Refer to *To Set the Screen Grid*.



#### NOTE

Advanced settings are not available for now. The current settings can yield the best display.

### Phase Deviation Measurement

In this mode, you can use the Lissajous method to measure the phase deviation of the two input signals whose frequencies are the same. The following figure shows the measurement schematic diagram of phase deviation.

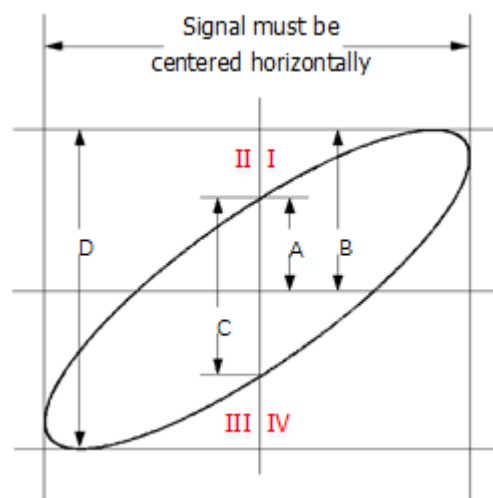

**Figure 7.5 Measurement Schematic Diagram of Phase Deviation**

According to  $\sin\theta = A/B$  or  $C/D$ ,  $\theta$  is the phase deviation angle between the two channels. The definitions of A, B, C, and D are shown in the figure above. The phase deviation angle is obtained, that is:

$$\theta = \pm \arcsin(A/B) \text{ or } \pm \arcsin(C/D)$$

If the principal axis of the ellipse is within Quadrant I and III, the phase deviation angle obtained should be within Quadrant I and IV, namely within  $(0 \text{ to } \pi/2)$  or  $(3\pi/2 \text{ to } 2\pi)$ . If the principal axis of the ellipse is within Quadrant II and IV, the phase deviation angle obtained should be within Quadrant II and III, namely within  $(\pi/2 \text{ to } \pi)$  or  $(\pi \text{ to } 3\pi/2)$ .

The XY mode can be used to measure the phase deviation occurred when the signal under test passes through a circuit network. Connect the oscilloscope to the circuit to monitor the input and output signals of the circuit.

## 8 Triggering the Oscilloscope

The trigger system allows you to set specific trigger conditions as required. The oscilloscope captures a waveform as well as its neighboring part and displays them on the screen once a particular trigger condition is met. For a digital oscilloscope, it samples waveform continuously no matter whether it is stably triggered. Rather, only stable triggering can produce stable display. The trigger module ensures that every time base sweep or acquisition starts from the user-defined trigger condition, namely every sweep is synchronous with the acquisition and the waveforms acquired are overlapped so as to display the stable waveforms.

You should set the triggers based on the features of the input signal. To quickly capture your desired waveforms, you need to understand the signal under test. This oscilloscope provides a variety of trigger types that help you focus on the desired waveform details.

You can enter the **Trigger** menu in the following ways:

- Press the front-panel  key to enter the trigger menu.
- In *Vertical System* menu, click or tap the **Trigger** button to enter the trigger menu.
- Click or tap the trigger label (as shown in the figure below) at the top of the screen to enter the trigger menu.



### 8.1 Trigger Source

In the "Trigger" menu, click or tap the drop-down button of **Source** to select the desired source. Analog channels (CH1-CH4), AC Line, or EXT (external trigger) can all be selected as the trigger source.

#### Analog channel input

Signals input from analog channels CH1-CH4 can all be used as trigger sources. No matter whether the channel selected is enabled, the channel can work normally.

#### AC line input



The trigger signal is obtained from the AC power input of the oscilloscope. AC trigger is usually used to measure signals relevant to the AC power frequency. For example, it can stably trigger the waveform output from the transformer of a transformer substation. It is mainly used in related measurements of the power industry.



## External trigger input

The external trigger source can be used to trigger on the fifth channel while all the other four channels are acquiring data. The trigger signal (e.g. external clock or signal of the circuit under test) will be connected to **EXT** trigger source via the external trigger input terminal [**EXT TRIG**] connector. You can set the trigger conditions within the range of the trigger level (from -8 V to +8 V).

## 8.2 Trigger Level

Trigger level determines where on the selected edge the trigger point occurs. The adjustment of the trigger level is related to the type of the trigger source.

- When the trigger source is CH1-CH4, rotate the front-panel  **LEVEL** knob or use the corresponding multipurpose knob (when the trigger menu is opened) to adjust the trigger level. You can also click or tap the **Level** input field to set the value with the pop-up numeric keypad. During the adjustment, a trigger level line (the color of the trigger level line is the same as that of the channel) and a trigger icon " " are displayed on the screen, and they move up and down with the variation of the trigger level. When you stopping modifying the trigger level, the trigger level line disappears in about 2 s. The current trigger level is displayed in the the trigger information label at the top of the screen.

In Runt Trigger, Slope Trigger, and Window trigger, you need to set the upper and lower limits of the trigger level. Two trigger level icons  and  are displayed at the right section of the screen.

- When the trigger source is AC Line, there is no trigger level.
- When the trigger source is EXT, rotate the front-panel  **LEVEL** knob or use the corresponding multipurpose knob (when the trigger menu is opened) to adjust the trigger level. You can also click or tap the **Level** input field to set the value with the pop-up numeric keypad. The current trigger level is displayed in the the trigger information label at the top of the screen.

For this trigger source, only the variation of the trigger level value is displayed on the screen during the adjustment of the trigger level, without displaying the trigger level lines on the screen.

To better trigger the waveforms, for a trigger with a single level, you can directly click or tap **50%** in the menu or press the trigger level knob to make the level move to the middle of the waveform. However, for a trigger with two levels (e.g. Slope trigger, Runt trigger, Window trigger), you need to click or tap **90%** for Level A and **10%** for Level B to make the level move within the range of the waveform amplitude.

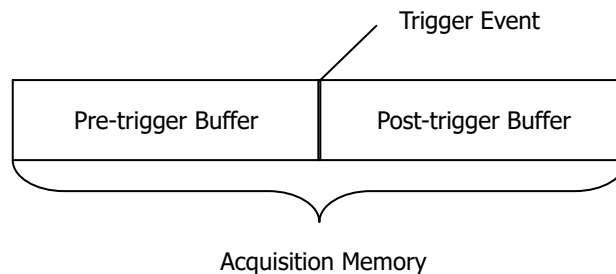

## 8.3 Trigger Mode

The following is the schematic diagram of the acquisition memory. To better understand the trigger event, you can think of the trigger event as dividing acquisition memory into a pre-trigger and post-trigger buffer.



**Figure 8.1 Schematic Diagram of the Acquisition Memory**

After the oscilloscope starts running, it first fills the pre-trigger buffer. Then, after the pre-trigger buffer is filled, the oscilloscope starts searching for a trigger. While searching for the trigger, the data sampled will still be transmitted to the pre-trigger buffer (the new data will continuously overwrite the previous data). When a trigger is found, the pre-trigger buffer contains the events that occurred just before the trigger. Then, the oscilloscope will fill the post-trigger buffer and display the data in the

acquisition memory. If the acquisition is initiated via the front-panel  key, the process repeats; if the acquisition is initiated via the  key, it stops after finishing a single acquisition (you can pan and zoom the currently displayed waveform).

This series provides Auto (default), Normal, and Single trigger modes.

Click or tap the trigger information label (as shown in the figure below) at the top of

the screen or press the front-panel  key to open the "Trigger" menu. In the **Sweep** item, you can quickly switch the current trigger mode. The selected trigger mode is displayed in the trigger information label at the top of the screen: A (Auto), N (Normal), or S (Single).



- **Auto:** In this trigger mode, if the specified trigger conditions are not found, triggers are forced and acquisitions are made so that signal activity is displayed on the oscilloscope. This trigger mode can be used when the signal levels are unknown, when the DC signals should be displayed, or when trigger conditions occur often enough that forced triggers are unnecessary.



- **Normal:** In this trigger mode, triggers and acquisitions only occur when the specified trigger conditions are found. This trigger mode can be used when the signal is at a low repetition rate, when you only want to acquire specific events specified by the trigger settings, or when you try to stabilize the display by preventing the oscilloscope from auto-triggering.
- **Single:** In this trigger mode, a single trigger and acquisition only occur when the specified trigger conditions are found, and then the oscilloscope stops. This trigger mode can be used when you need to make a single acquisition of the specified event and analyze the acquisition result. You can pan and zoom the currently displayed waveform without subsequent waveform data overwriting the current waveform. After a single trigger is initiated, the oscilloscope is in "STOP" state.

In **Normal** and **Single** trigger modes, you can click or tap the **Force** button in the trigger menu or press the front-panel  key to force a trigger event.

## 8.4 Trigger Coupling

Trigger coupling determines what part of the signal is passed to the trigger circuit. Please distinguish it from channel coupling (*To Specify Channel Coupling*). This function is available only when the trigger type is Edge and the trigger source is an analog channel.

In the "Trigger" menu, click or tap the **Coupling** drop-down button to select the desired coupling mode (by default, it is DC).



- **DC:** allows DC and AC components to pass the trigger circuitry.
- **AC:** blocks the DC components and attenuates the signals.
- **LFR:** blocks the DC components and rejects the low-frequency components.
- **HFR:** rejects the high frequency components.

### TIP



When "AC" or "LFR" is selected as the coupling mode, no trigger level lines and trigger icons are displayed. When you adjust the trigger level, you can only see the changes of the trigger level values in the trigger information label at the top of the screen.

## 8.5 Trigger Holdoff

Trigger holdoff can help stabilize triggering on complex repetitive waveforms that have multiple edges or other events between waveform repetitions (such as pulse series). Holdoff time is specified as the amount of time that the oscilloscope waits for re-arming the trigger circuitry after generating a correct trigger. The oscilloscope will not trigger even if the trigger condition is met during the holdoff time and will only re-arm the trigger circuitry after the holdoff time expires.

For example, to get a stable trigger on the repetitive pulse burst as shown in the figure below, set the holdoff time to be greater than  $t_1$  but less than  $t_2$ .

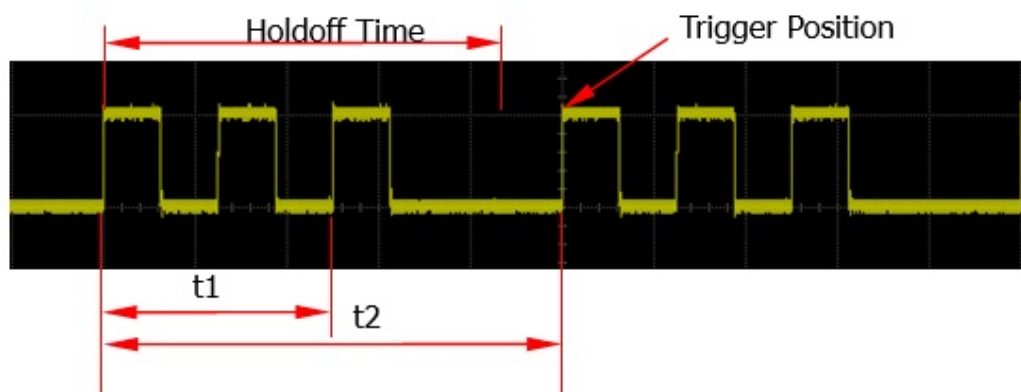



Figure 8.2 Trigger Holdoff

Click or tap the trigger information label (as shown in the figure below) at the top of the screen or press the front-panel  key to open the "Trigger" menu. Click or tap the input field of **Holdoff** to set the holdoff time (the holdoff to this time when the waveforms are stably triggered) with the pop-up numeric keypad. You can also use the corresponding multipurpose knob to set the value. The adjustable range of the holdoff time is from 8 ns (default) to 10 s.



## 8.6 Noise Rejection

Noise rejection can reject the high frequency noise in the signal and reduce the possibility of triggering the oscilloscope by mistake.

Click or tap the trigger information label (as shown in the figure below) or press the front-panel  key to open the "Trigger" menu. Click or tap the **Noise Reject** on/off switch to enable or disable the noise rejection function.

**TIP**

This function is available only when the trigger source is set to an analog channel or EXT.

## 8.7 Trigger Type

This series oscilloscope provides the following trigger types.

### 8.7.1 Edge Trigger

Edge trigger identifies a trigger on the trigger level of the specified edge on the input signal.

**Trigger Type**

Click or tap the **Type** drop-down button to select "Edge".

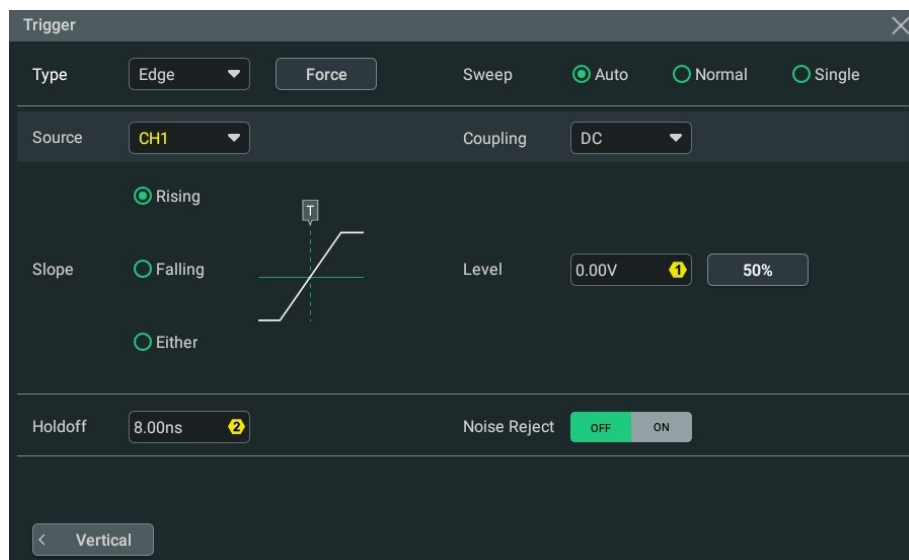

**Figure 8.3 Edge Trigger Setting Menu**

After a trigger type is selected, the current trigger setting information (including the trigger type, source, and level) is displayed in the trigger information label at the top of the screen, as shown in the figure below. The information will change based on the trigger settings.



### Source Selection

Click or tap **Source** drop-down button to select CH1-CH4, AC Line, or EXT. For details, refer to *Trigger Source*. The selected trigger source is indicated in the trigger information label at the top of the screen.

Only when you select the channel that has signal inputs as the trigger source, can you obtain a stable trigger.

### Edge Type

In the **Slope** item, select which edge of the input signal will trigger the oscilloscope. The selected slope will be indicated in the trigger information label.

- Rising: triggers on the rising edge of the input signal when the voltage level meets the specified trigger level.
- Falling: triggers on the falling edge of the input signal when the voltage level meets the specified trigger level.
- Either: triggers on the rising or falling edge of the input signal when the voltage level meets the preset trigger level.

### Trigger Mode

In **Sweep**, select Auto, Normal, or Single as the trigger mode. For details, refer to *Trigger Mode*.

### Trigger Parameter Setting

You can refer to *Trigger Coupling*, *Trigger Holdoff*, and *Noise Rejection* to set the trigger coupling, trigger holdoff, and noise rejection under this trigger type.

### Trigger Level

Click or tap the **Level** input field to set the trigger level with the pop-up numeric keypad. You can also use the front-panel trigger level knob or the corresponding multipurpose knob to set the trigger level. For details, refer to descriptions in *Trigger Level*. The current trigger level is displayed in the trigger information label at the top of the screen.

## 8.7.2 Pulse Width Trigger

Pulse width triggering sets the oscilloscope to trigger on the positive or negative pulse of a specified width. In this mode, the oscilloscope will trigger when the pulse width of the input signal satisfies the specified pulse width condition.

In this oscilloscope, positive pulse width is defined as the time difference between the two crossing points of the trigger level and positive pulse; negative pulse width is defined as the time difference between the two crossing points of the trigger level and negative pulse, as shown in the figure below.

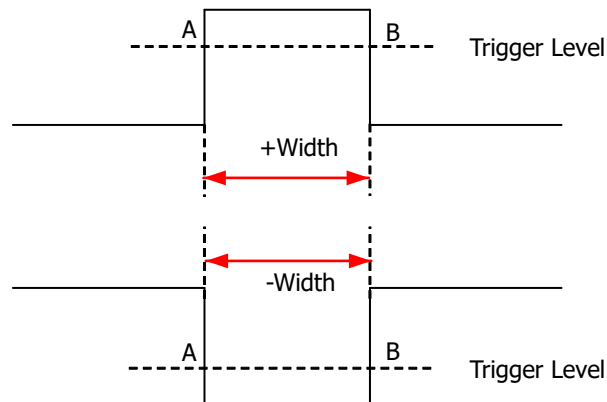

Figure 8.4 Positive/Negative Pulse Width

### Trigger Type

Click or tap **Type** drop-down button to select "Pulse".

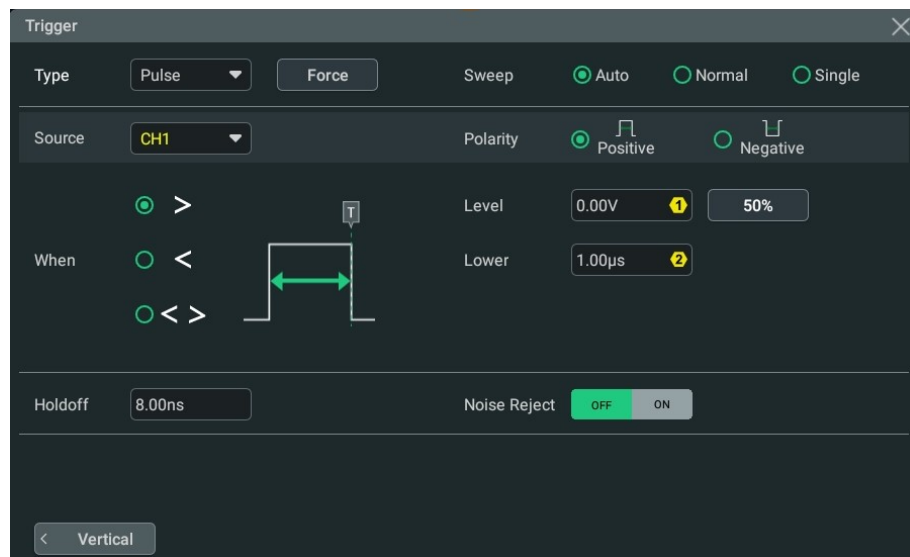

Figure 8.5 Pulse Width Trigger Setting Menu

After a trigger type is selected, the current trigger setting information (including trigger type, trigger source, and trigger level) is displayed in the trigger information label at the top of the screen, as shown in the figure below. The information will change based on the trigger settings.





### Source Selection

Click or tap **Source** drop-down button to select CH1-CH4. For details, refer to *Trigger Source*. The selected trigger source is indicated in the trigger information label at the top of the screen.

Only when you select the channel that has signal inputs as the trigger source, can you obtain a stable trigger.

### Polarity

In the **Polarity** item, select the desired polarity: positive polarity () or negative polarity ()

### Trigger Condition

Set the trigger condition in the **When** item.

- When you select "Positive" for polarity, ">" for trigger condition, the oscilloscope triggers when the positive pulse width of the input signal is greater than the specified pulse width.
- When you select "Positive" for polarity, "<" for trigger condition, the oscilloscope triggers when the positive pulse width of the input signal is smaller than the specified pulse width.
- When you select "Positive" for polarity, "< >" for trigger condition, the oscilloscope triggers when the positive pulse width of the input signal is greater than the specified lower limit of pulse width and smaller than the specified upper limit of pulse width.
- When you select "Negative" for polarity, ">" for trigger condition, the oscilloscope triggers when the negative pulse width of the input signal is greater than the specified pulse width.
- When you select "Negative" for polarity, "<" for trigger condition, the oscilloscope triggers when the negative pulse width of the input signal is smaller than the specified pulse width.
- When you select "Negative" for polarity, "< >" for trigger condition, the oscilloscope triggers when the negative pulse width of the input signal is greater than the specified lower limit of pulse width and smaller than the specified upper limit of pulse width.

### Pulse Width Setting

- In the **When** menu, when ">" or "<" is selected, click or tap the input field of **Lower** or **Upper** to set the lower limit value or the upper limit value with the pop-up numeric keypad. You can also use the corresponding knob to set the value. The pulse width available is from 100 ps to 10 s.

- In the **When** menu, when "< >" is selected, click or tap the input field of **Upper** and **Lower** respectively to set the lower limit value and the upper limit value with the pop-up numeric keypad. You can also use the corresponding knob to set the values. The lower limit of the pulse width must be smaller than the upper limit.

### Trigger Mode

In **Sweep**, select Auto, Normal, or Single as the trigger mode. For details, refer to *Trigger Mode*.

### Trigger Parameter Setting

You can refer to *Trigger Holdoff* and *Noise Rejection* to set the trigger holdoff and noise rejection under this trigger type.

### Trigger Level

Click or tap the **Level** input field to set the trigger level with the pop-up numeric keypad. You can also use the front-panel trigger level knob or the corresponding multipurpose knob to set the trigger level. For details, refer to descriptions in *Trigger Level*. The current trigger level is displayed in the trigger information label at the top of the screen.

## 8.7.3 Slope Trigger

Slope triggering sets the oscilloscope to trigger on the positive or negative slope of the specified time. This trigger mode is applicable to ramp and triangle waveforms.

In this oscilloscope, positive slope time is defined as the time difference between the two crossing points of trigger level line A and B with the rising edge; negative slope time is defined as the time difference between the two crossing points of trigger level line A and B with the falling edge. See the figure below.

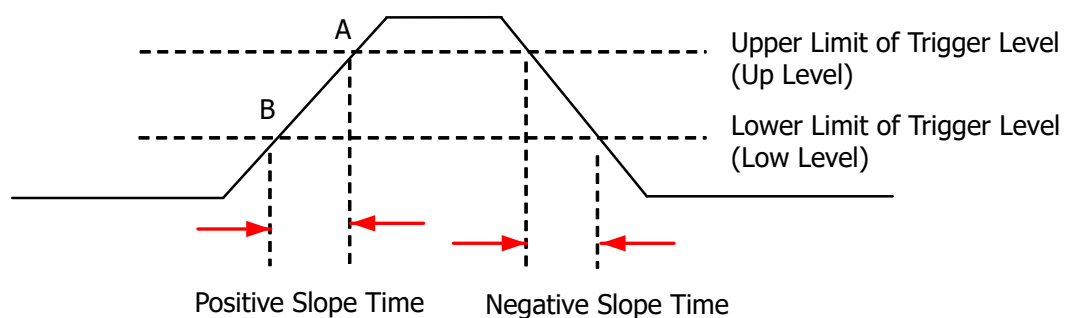

**Figure 8.6 Positive Slope Time/Negative Slope Time**

### Trigger Type

Click or tap the **Type** drop-down button to select "Slope".

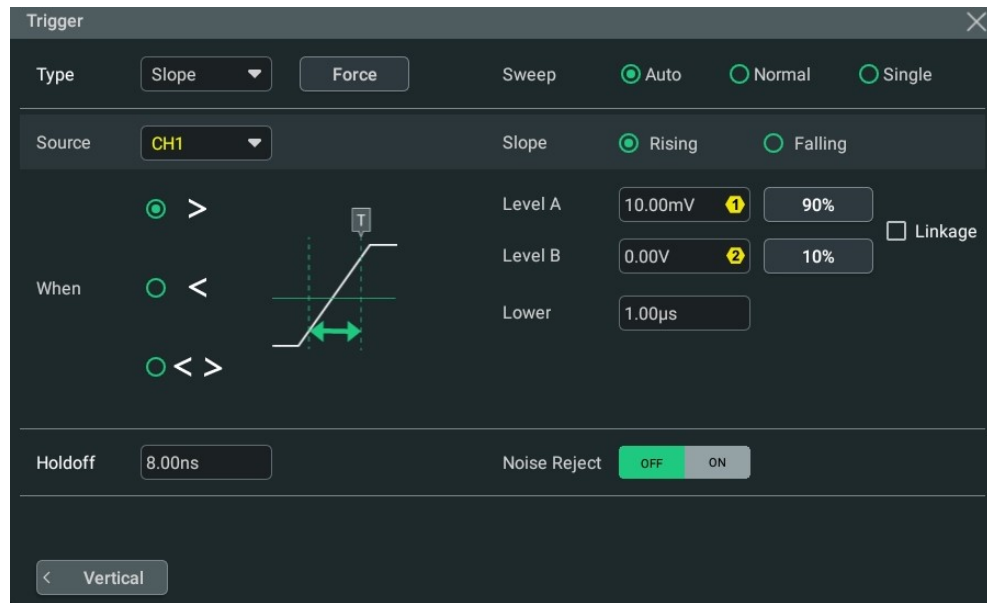

**Figure 8.7 Slope Trigger Setting Menu**

After a trigger type is selected, the current trigger setting information (including trigger type, trigger source, and trigger level) is displayed in the trigger information label at the top of the screen, as shown in the figure below. The information will change based on the trigger settings.



### Source Selection

Click or tap **Source** drop-down button to select CH1-CH4. For details, refer to *Trigger Source*. The selected trigger source is indicated in the trigger information label at the top of the screen.

Only when you select the channel that has signal inputs as the trigger source, can you obtain a stable trigger.

### Edge Type

Select the input signal edge (in the **Slope** menu) on which the oscilloscope triggers.

- Rising: triggers on the rising edge of the input signal.
- Falling: triggers on the falling edge of the input signal.

### Trigger Condition:

Sets the trigger condition in the **When** item.



- When you select "Rising" for the edge type, ">" for trigger condition, the oscilloscope triggers when the positive slope time of the input signal is greater than the specified time.
- When you select "Rising" for the edge type, "<" for trigger condition, the oscilloscope triggers when the positive slope time of the input signal is smaller than the specified time.
- When you select "Rising" for the edge type, "< >" for trigger condition, the oscilloscope triggers when the positive slope time of the input signal is greater than the specified lower limit time and smaller than the specified upper limit time.
- When you select "Falling" for the edge type, ">" for trigger condition, the oscilloscope triggers when the negative slope time of the input signal is greater than the specified time.
- When you select "Falling" for the edge type, "<" for trigger condition, the oscilloscope triggers when the negative slope time of the input signal is smaller than the specified time.
- When you select "Falling" for the edge type, "< >" for trigger condition, the oscilloscope triggers when the negative slope time of the input signal is greater than the specified lower limit time and smaller than the specified upper limit time.

### Slope Time Setting

- In the **When** item, when ">" or "<" is set to trigger conditions, click or tap the input field of **Lower** or **Upper** to set the lower limit value or the upper limit value with the pop-up numeric keypad. You can also use the corresponding knob to set the value. The slope time available is from 100 ps to 10 s.
- In the **When** item, when "< >" is set to trigger conditions, click or tap the input field of **Upper** and **Lower** respectively to set the lower limit value and the upper limit value with the pop-up numeric keypad. You can also use the corresponding knob to set the values. The lower slope time limit must be smaller than the upper slope time limit.

### Trigger Mode

In **Sweep**, select Auto, Normal, or Single as the trigger mode. For details, refer to *Trigger Mode*.

### Trigger Parameter Setting

You can refer to *Trigger Holdoff* and *Noise Rejection* to set the trigger holdoff and noise rejection under this trigger type.

## Level Selection and Setting

After the trigger condition setting is completed, you need to adjust the trigger level to correctly trigger the signal and obtain a stable waveform.

Click or tap the **Level A/Level B** input field to set the level A/level B with the pop-up numeric keypad. You can also use the corresponding multipurpose knob to adjust level A/level B or use the trigger level knob to adjust level A. When **Linkage** is ticked, the upper limit and lower limit values change at the same time. The difference between upper and lower limit remains unchanged. For details, refer to *Trigger Level*. The current trigger level is displayed in the trigger information label at the top of the screen.

## 8.7.4 Video Trigger

The video signal can include image information and timing information, which adopts different standards and formats. This series can trigger on the standard video signal field or line of NTSC (National Television Standards Committee), PAL (Phase Alternating Line), or SECAM (Sequential Couleur A Memoire).

### Trigger Type

Click or tap the **Type** drop-down button to select "Video".

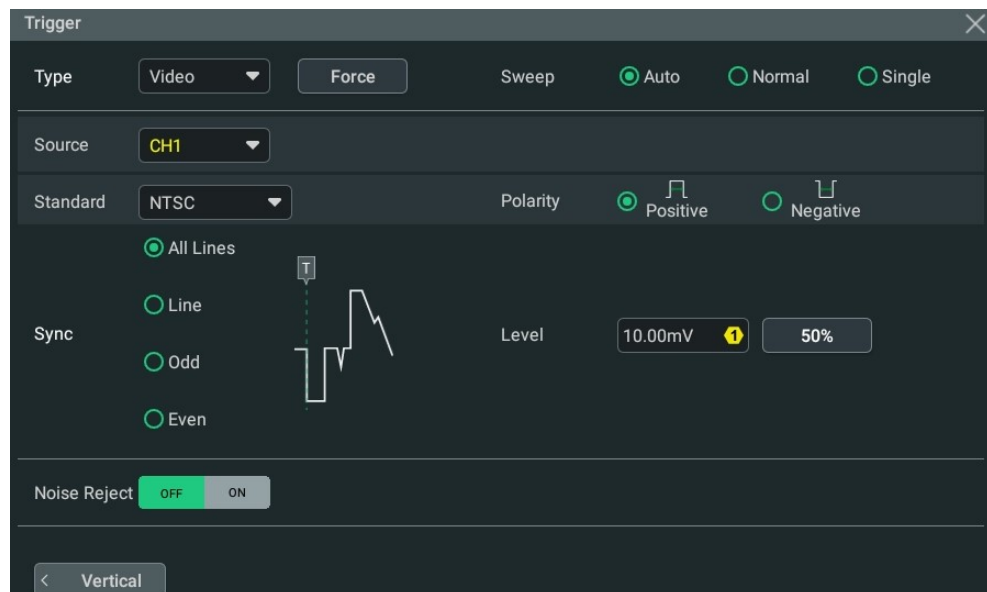

**Figure 8.8 Video Trigger Setting Menu**

After a trigger type is selected, the current trigger setting information (including trigger type, trigger source, and trigger level) is displayed in the trigger information label at the top of the screen, as shown in the figure below. The information will change based on the trigger settings.





### Source Selection

Click or tap **Source** drop-down button to select CH1-CH4. For details, refer to *Trigger Source*. The selected trigger source is indicated in the trigger information label at the top of the screen.

Only when you select the channel that has signal inputs as the trigger source, can you obtain a stable trigger.

### Video Polarity

In the **Polarity** item, select the desired polarity: positive polarity () or negative polarity ()

### Video Standard

Click or tap the drop-down button of **Standard** to select the desired video standard.

**Table 8.1 Video Standard**

Video Standard	Frame Frequency (Frame)	Scan Type	TV Scan Line
NTSC	30	Interlaced Scan	525
PAL/SECAM	25	Interlaced Scan	625
480p/60Hz	60	Progressive Scan	525
576p/50Hz	50	Progressive Scan	625
720p/60Hz	60	Progressive Scan	750
720p/50Hz	50	Progressive Scan	750
720p/30Hz	30	Progressive Scan	750
720p/25Hz	25	Progressive Scan	750
720p/24Hz	24	Progressive Scan	750
1080p/60Hz	60	Progressive Scan	1125
1080p/50Hz	50	Progressive Scan	1125
1080p/30Hz	30	Progressive Scan	1125
1080p/25Hz	25	Progressive Scan	1125
1080p/24Hz	24	Progressive Scan	1125
1080i/60Hz	60	Interlaced Scan	1125
1080i/50Hz	50	Interlaced Scan	1125

### Sync

In the **Sync** item, select the desired sync type.

- All Lines: triggers on the first line found.
- Line: triggers on the specified line.

When this sync type is selected, you can specify a line number. Click or tap the input field of **Line** to set the line number by using the pop-up numeric keypad. You can also use the corresponding multipurpose knob to set the value. The range of the line number is related to the currently selected video standards. The range is from 1 to 525 (NTSC), 1 to 625 (PAL/SECAM), 1 to 525 (480p), 1 to 625 (576p), 1 to 750 (720p), or 1 to 1125 (1080p/ 1080i).

- Odd: triggers on the rising edge of the first ramp pulse in the odd field. It is only available when the video standard is set to "NTSC" or "PAL/SECAM".
- Even: triggers on the rising edge of the first ramp pulse in the even field. It is only available when the video standard is set to "NTSC" or "PAL/SECAM".

### Trigger Mode

In **Sweep**, select Auto, Normal, or Single as the trigger mode. For details, refer to *Trigger Mode*.

### Trigger Parameter Setting

You can refer to *Noise Rejection* to set the noise rejection under this trigger type.

### Trigger Level

Click or tap the **Level** input field to set the trigger level with the pop-up numeric keypad. You can also use the front-panel trigger level knob or the corresponding multipurpose knob to set the trigger level. For details, refer to descriptions in *Trigger Level*. The current trigger level is displayed in the trigger information label at the top of the screen.

### TIP

- To better observe the waveform details in the video signal, you can set a larger memory depth first.
- In the trigger debugging process of video signals, the frequency in different part of the signal can be reflected by a different brightness, as RIGOL's digital oscilloscope provides the intensity graded color display function. Experienced users can quickly judge the signal quality and discover abnormalities during the debugging process.



## 8.7.5 Pattern Trigger

The pattern trigger identifies a trigger condition by looking for a specified pattern. This pattern is a logical "AND" combination of channels. Each channel can be set to H (high), L (low), or X (don't care). A rising or falling edge (you can only specify a single edge) can be specified for one channel included in the pattern. When an edge is specified, the oscilloscope will trigger at the edge specified if the pattern set for the other channels are true (namely the actual pattern of the channel is the same as the

preset pattern). If no edge is specified, the oscilloscope will trigger on the last edge that makes the pattern true. If all the channels in the pattern are set to "X", the oscilloscope will not trigger.

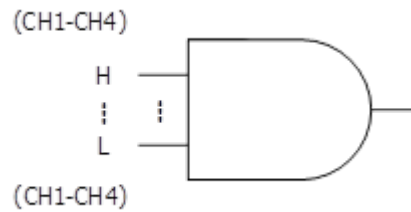

Figure 8.9 Pattern Trigger

### Trigger Type

Click or tap the **Type** drop-down button to select "Pattern".

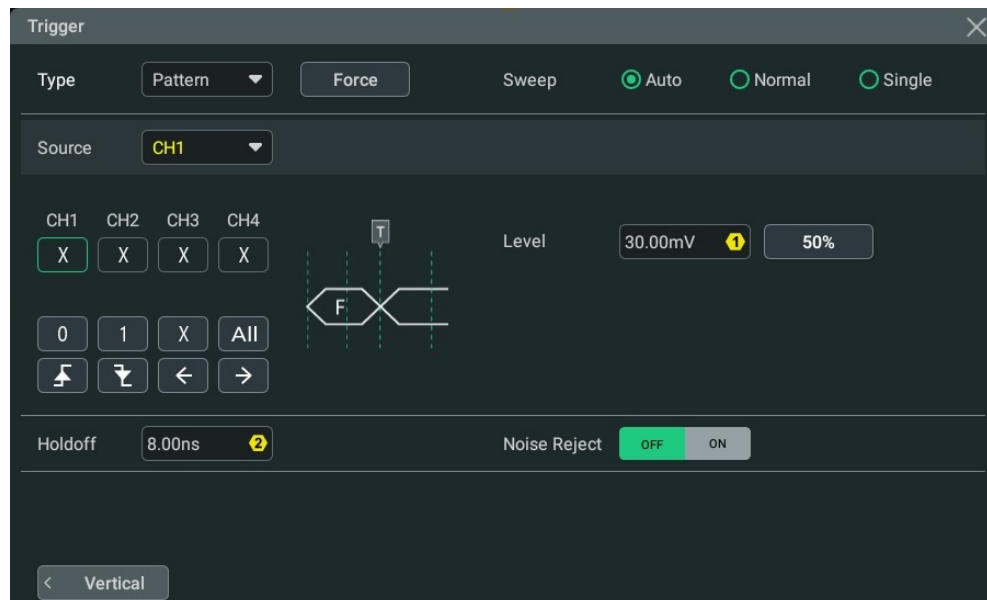

Figure 8.10 Pattern Trigger Setting Menu

After a trigger type is selected, the current trigger setting information (including trigger type, trigger source, and trigger level) is displayed in the trigger information label at the top of the screen, as shown in the figure below. The information will change based on the trigger settings.





### Source Selection

Click or tap **Source** drop-down button to select CH1-CH4. For details, refer to *Trigger Source*. The selected trigger source is indicated in the trigger information label at the top of the screen.

Only when you select the channel that has signal inputs as the trigger source, can you obtain a stable trigger.

### Pattern Setting

The following five patterns are available:

- 1: sets the pattern of the channel selected to "1", i.e. the voltage level is higher than the trigger level of the channel.
- 0: sets the pattern of the channel selected to "0", i.e. the voltage level is lower than the trigger level of the channel.
- X: sets the pattern of the channel selected to "X", i.e. this channel is not used as a part of the pattern. When all channels in the pattern are set to "X", the oscilloscope will not trigger.
- : sets the pattern to the rising edge of the channel selected.
- : sets the pattern to the falling edge of the channel selected.

The Left/Right arrow key indicates moving left/right to switch the channel pattern. "All" indicates all bits. Select a pattern for a channel and then click or tap **All**. The patterns of all the other channels will be set to the currently selected pattern. The pattern setting is as shown in the figure below.



Only one edge (rising or falling edge) can be specified in the pattern. If one edge item is currently defined and then another edge item is defined in another channel in the pattern, then a prompt message "Invalid input" is displayed.

### Trigger Mode

In **Sweep**, select Auto, Normal, or Single as the trigger mode. For details, refer to *Trigger Mode*.

### Trigger Parameter Setting

You can refer to *Trigger Holdoff* and *Noise Rejection* to set the trigger holdoff and noise rejection under this trigger type.

### Trigger Level

Click or tap the **Level** input field to set the trigger level with the pop-up numeric keypad. You can also use the front-panel trigger level knob or the corresponding multipurpose knob to set the trigger level. For details, refer to descriptions in *Trigger Level*. The current trigger level is displayed in the trigger information label at the top of the screen.

## 8.7.6 Duration Trigger

In duration trigger, the oscilloscope identifies a trigger condition by searching for the duration of a specified pattern. This pattern is a logical "AND" combination of the channels. Each channel can be set to 1 (high), 0 (low), or X (don't care). The instrument triggers when the duration ( $\Delta T$ ) of this pattern meets the preset time, as shown in the figure below.

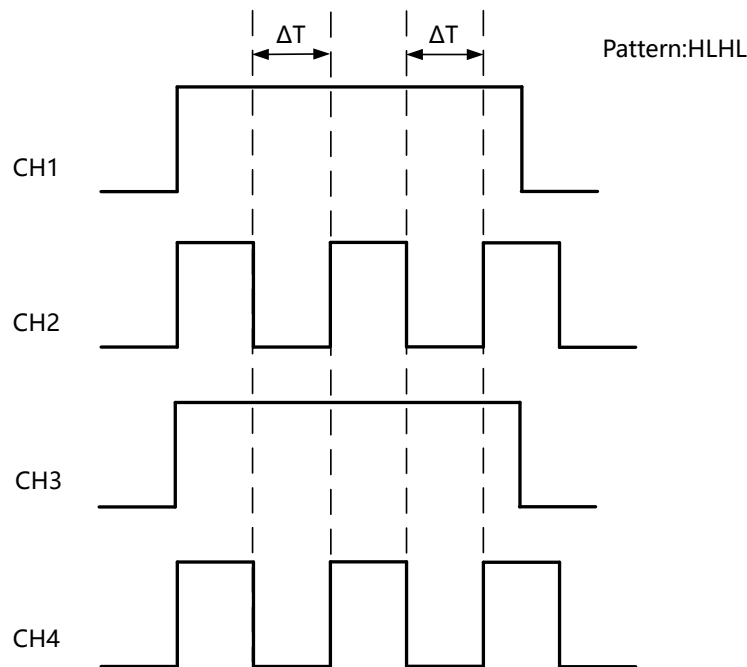
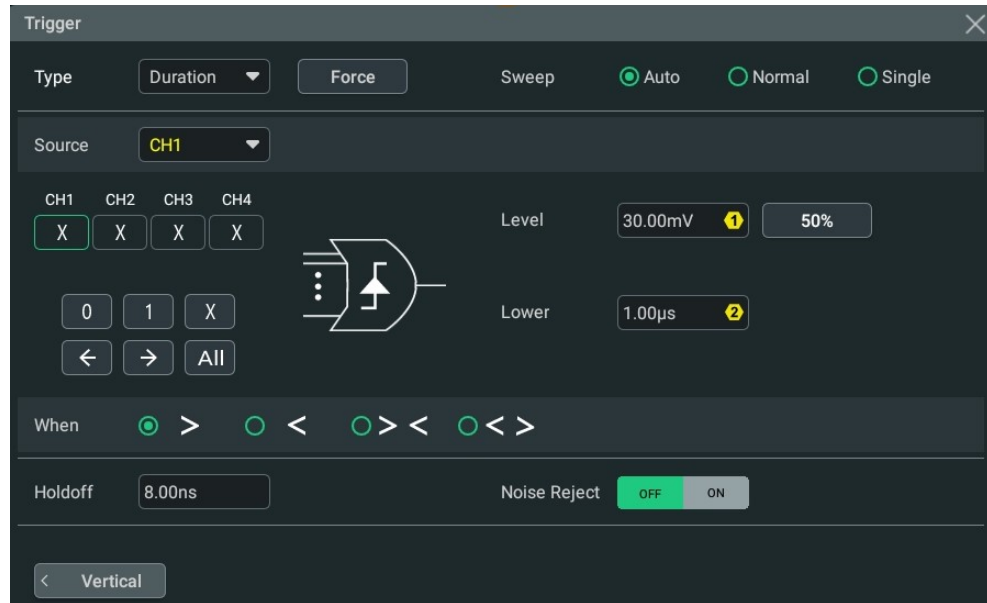

Figure 8.11 Duration Trigger

### Trigger Type

Click or tap the **Type** drop-down button to select "Duration".



**Figure 8.12 Duration Trigger Setting Menu**

After a trigger type is selected, the current trigger setting information (including trigger type, trigger source, and trigger level) is displayed in the trigger information label at the top of the screen, as shown in the figure below. The information will change based on the trigger settings.



### Source Selection

Click or tap **Source** drop-down button to select CH1-CH4. For details, refer to *Trigger Source*. The selected trigger source is indicated in the trigger information label at the top of the screen.

Only when you select the channel that has signal inputs as the trigger source, can you obtain a stable trigger.

### Pattern Setting

The following three patterns are available:

- 1: sets the pattern of the channel selected to "1", i.e. the voltage level is higher than the trigger level of the channel.
- 0: sets the pattern of the channel selected to "0", i.e. the voltage level is lower than the trigger level of the channel.
- X: sets the pattern of the channel selected to "X", i.e. this channel is not used as a part of the pattern. When all channels in the pattern are set to "X", the oscilloscope will not trigger.



The Left/Right arrow key indicates moving left/right to switch the channel pattern. "All" indicates all bits. Select a pattern for a channel, then click or tap **All**. The patterns of all the other channels will be set to the currently selected pattern.

### Trigger Condition

Sets the trigger condition in the **When** item.

- **>**: triggers when the duration of the pattern is greater than the preset time. Click or tap the input field of **Lower** to set the lower limit of the duration of the pattern with the pop-up numeric keypad. You can also use the corresponding multipurpose knob to set the value. Its range is from 100 ps to 10 s.
- **<**: triggers when the duration of the pattern is smaller than the preset time. Click or tap the input field of **Upper** to set the upper limit of the duration of the pattern. You can also use the corresponding multipurpose knob to set the value. Its range is from 100 ps to 10 s.
- **< >**: triggers when the duration of the pattern is smaller than the upper limit of the preset time and greater than the lower limit of the preset time. Click or tap the input field of **Upper** to set the upper limit of the duration of the pattern, and the range is from 101 ps to 10 s. Click or tap the input field of **Lower** to set the lower limit of the duration of the pattern, and the range is from 100 ps to 9.9 s. You can also use the corresponding multipurpose knob to set the upper/lower limit. The lower time limit must be smaller than the upper time limit.
- **> <**: triggers when the duration of the pattern is greater than the upper limit of the preset time or smaller than the lower limit of the preset time. Click or tap the input field of **Upper** to set the upper limit of the duration of the pattern, and the range is from 100 ps to 10 s. Click or tap the input field of **Lower** to set the lower limit of the duration of the pattern, and the range is from 100 ps to 9.9 s. You can also use the corresponding multipurpose knob to set the upper and lower limit. The lower time limit must be smaller than the upper time limit.

### Trigger Mode

In **Sweep**, select Auto, Normal, or Single as the trigger mode. For details, refer to *Trigger Mode*.

### Trigger Parameter Setting

You can refer to *Trigger Holdoff* and *Noise Rejection* to set the trigger holdoff and noise rejection under this trigger type.

### Trigger Level

Click or tap the **Level** input field to set the trigger level with the pop-up numeric keypad. You can also use the front-panel trigger level knob or the corresponding multipurpose knob to set the trigger level. For details, refer to descriptions in *Trigger Level*. The current trigger level is displayed in the trigger information label at the top of the screen.

### 8.7.7 Timeout Trigger

In Timeout trigger, the oscilloscope triggers when the time interval ( $\Delta T$ ) (the time from when the rising edge (or falling edge) of the input signal passes through the trigger level to the time from when the neighboring falling edge (or rising edge) passes through the trigger level) is greater than the preset timeout value, as shown in *Figure 8.13*.

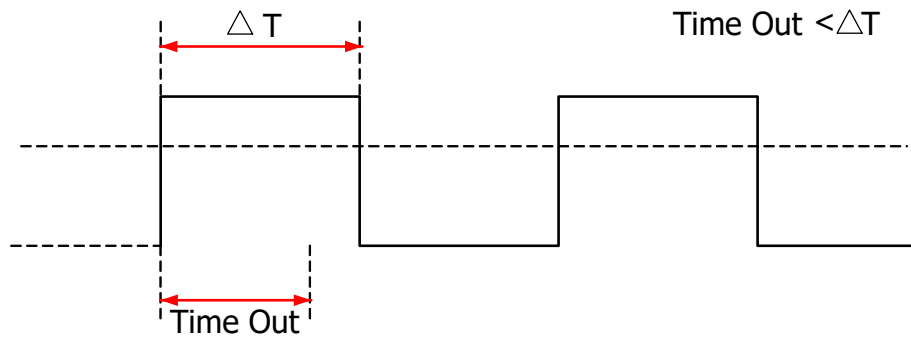

Figure 8.13 Timeout Trigger

#### Trigger Type

Click or tap the drop-down button of **Type** to select "Timeout".

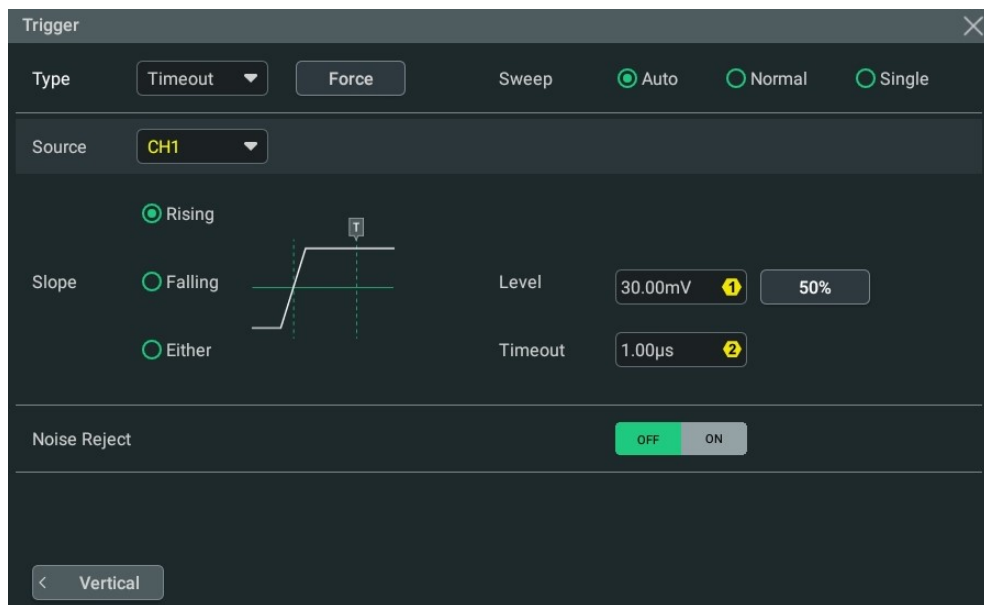

Figure 8.14 Timeout Trigger Menu

After a trigger type is selected, the current trigger setting information (including trigger type, trigger source, and trigger level) is displayed in the trigger information label at the top of the screen, as shown in the figure below. The information will change based on the trigger settings.



### Source Selection

Click or tap **Source** drop-down button to select CH1-CH4. For details, refer to *Trigger Source*. The selected trigger source is indicated in the trigger information label at the top of the screen.

Only when you select the channel that has signal inputs as the trigger source, can you obtain a stable trigger.

### Edge Type

In **Slope** item, select the edge type from which the input signal passes through the trigger level.

- Rising: starts timing when the rising edge of the input signal passes through the trigger level.
- Falling: starts timing when the falling edge of the input signal passes through the trigger level.
- Either: starts timing when either edge of the input signal passes through the trigger level.

### Timeout Value

Timeout value represents the maximum time that the signal remains idle before the signal passes through the trigger level. Click or tap the input field of **Timeout**, and then use the pop-up numeric keypad to set the timeout value of Timeout trigger. You can also use the corresponding multipurpose knob to set the value.

### Trigger Mode

In **Sweep**, select Auto, Normal, or Single as the trigger mode. For details, refer to *Trigger Mode*.

### Trigger Parameter Setting

You can refer to *Noise Rejection* to set the noise rejection under this trigger type.

### Trigger Level

Click or tap the **Level** input field to set the trigger level with the pop-up numeric keypad. You can also use the front-panel trigger level knob or the corresponding multipurpose knob to set the trigger level. For details, refer to descriptions in *Trigger Level*. The current trigger level is displayed in the trigger information label at the top of the screen.

### 8.7.8 Runt Trigger

The runt trigger sets the oscilloscope to trigger pulses that cross one trigger level but not another, as shown in the figure below.

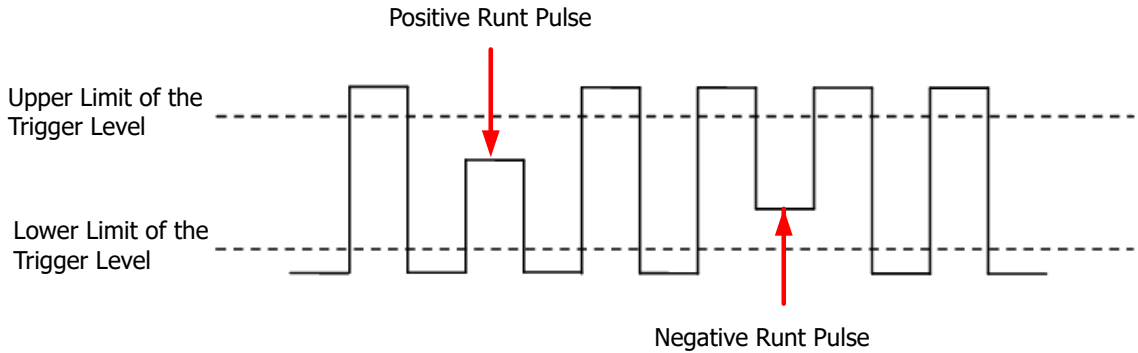

Figure 8.15 Runt Trigger

#### Trigger Type

Click or tap the drop-down button of **Type** to select "Runt".

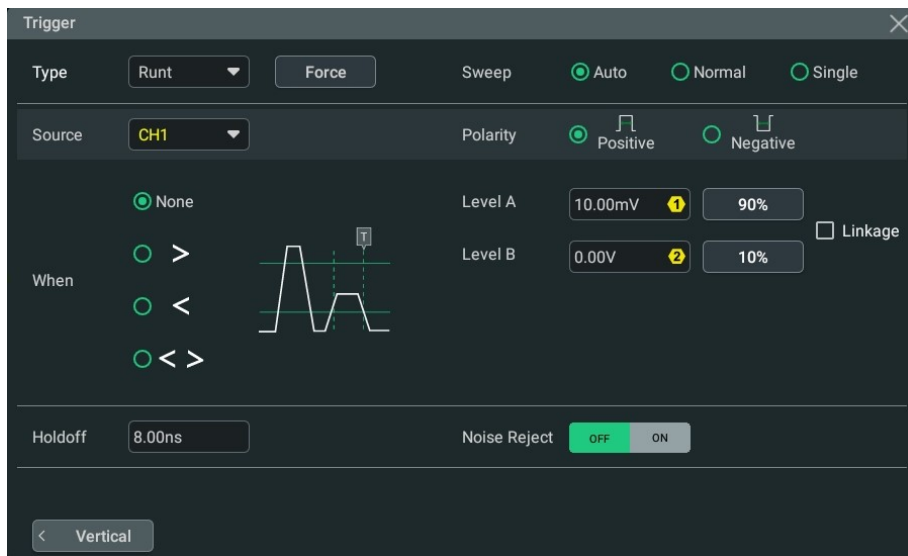
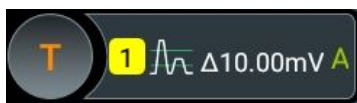

Figure 8.16 Runt Trigger Setting Menu

After a trigger type is selected, the current trigger setting information (including trigger type, trigger source, and trigger level) is displayed in the trigger information label at the top of the screen, as shown in the figure below. The information will change based on the trigger settings.





### Source Selection

Click or tap **Source** drop-down button to select CH1-CH4. For details, refer to *Trigger Source*. The selected trigger source is indicated in the trigger information label at the top of the screen.

Only when you select the channel that has signal inputs as the trigger source, can you obtain a stable trigger.

### Polarity

Selects the pulse polarity of Runt trigger under the **Polarity** item.

- Positive : triggers on the positive runt pulse.
- Negative : triggers on the negative runt pulse.

### Trigger Condition

Sets the Runt trigger condition in the **When** item.

- **None**: indicates not setting the trigger condition of Runt trigger.
- **>**: triggers when the runt pulse width is greater than the lower limit of pulse width. Click or tap the input field of **Lower** to set the minimum pulse width of Runt trigger with the pop-up numeric keypad. You can also use the corresponding multipurpose knob to modify the value.
- **<**: triggers when the runt pulse width is smaller than the upper limit of pulse width. Click or tap the input field of **Upper** to set the maximum pulse width of Runt trigger with the pop-up numeric keypad. You can also use the corresponding multipurpose knob to modify the value.
- **< >**: triggers when the runt pulse width is greater than the lower limit and smaller than the upper limit of pulse width. Click or tap the input field of **Upper** to set the maximum pulse width of Runt trigger with the pop-up numeric keypad. Click or tap the input field of **Lower** to set the minimum pulse width of Runt trigger with the pop-up numeric keypad. You can also use the corresponding multipurpose knob to modify the maximum and minimum pulse width. The lower limit of the pulse width must be smaller than the upper limit.

### Level Selection and Setting

After the trigger condition setting is completed, you need to adjust the trigger level to correctly trigger the signal and obtain a stable waveform.

Click or tap the **Level A/Level B** input field to set the level A/level B with the pop-up numeric keypad. You can also use the corresponding multipurpose knob to adjust level A/level B or use the trigger level knob to adjust level A. When **Linkage** is ticked, the upper limit and lower limit values change at the same time. The difference between upper and lower limit remains unchanged. For details, refer to *Trigger Level*.

The current trigger level is displayed in the trigger information label at the top of the screen.

### Trigger Mode

In **Sweep**, select Auto, Normal, or Single as the trigger mode. For details, refer to *Trigger Mode*.

### Trigger Parameter Setting

You can refer to *Trigger Holdoff* and *Noise Rejection* to set the trigger holdoff and noise rejection under this trigger type.

## 8.7.9 Window Trigger

Window trigger provides a high trigger level and a low trigger level. The instrument triggers when the input signal passes through the high trigger level or the low trigger level.

### Trigger Type

Click or tap the drop-down button of **Type** to select "Over".

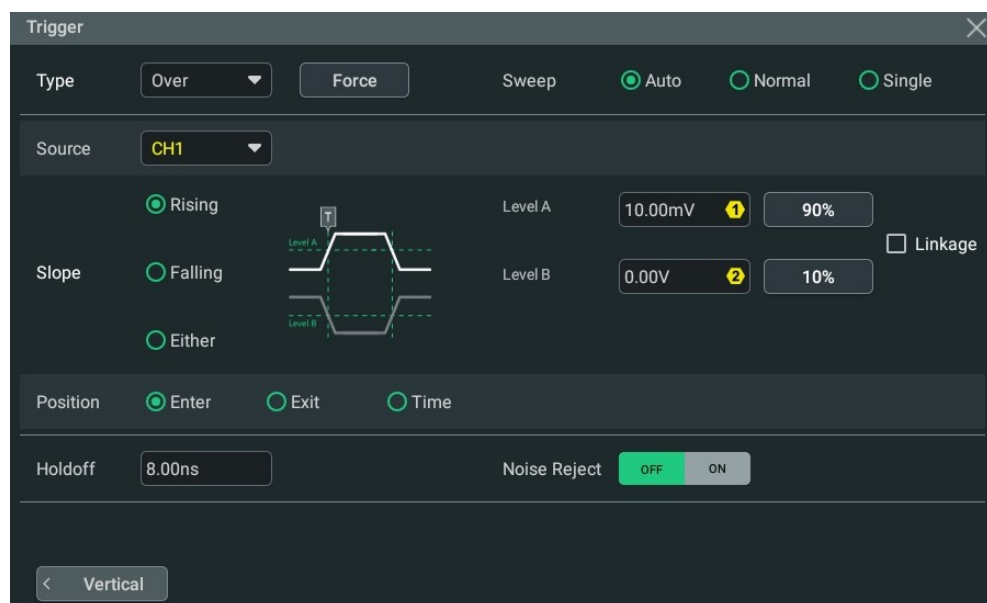
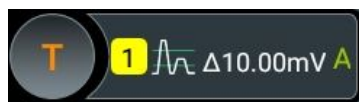

Figure 8.17 Window Trigger Setting Menu

After a trigger type is selected, the current trigger setting information (including trigger type, trigger source, and trigger level) is displayed in the trigger information label at the top of the screen, as shown in the figure below. The information will change based on the trigger settings.



### Source Selection

Click or tap the **Source** drop-down button to select CH1-CH4. For details, refer to *Trigger Source*. The selected trigger source is indicated in the trigger information label at the top of the screen.

Only when you select the channel that has signal inputs as the trigger source, can you obtain a stable trigger.

### Edge Type

Select the input signal edge (in the **Slope** item) on which the oscilloscope triggers.

- **Rising**: triggers on the rising edge of the input signal when the voltage level is higher than the preset high trigger level.
- **Falling**: triggers on the falling edge of the input signal when the voltage level is lower than the preset low trigger level.
- **Either**: triggers on the rising or falling edge of the input signal when the voltage level meets the preset trigger level.

### Trigger Position

After selecting the window type, specify the time point of trigger by selecting the trigger position (in **Position** item).

- **Enter**: triggers when the input signal enters the specified trigger level range.
- **Exit**: triggers when the input signal exits the specified trigger level range.
- **Time**: triggers when the accumulated hold time since the input signal entered the specified trigger level range is equal to the window time. After you select this type, click or tap the input field of **Time** to set it by using the pop-up numeric keypad. The available range is from 1 ns to 10 s.

### Level Selection and Setting

After the trigger condition setting is completed, you need to adjust the trigger level to correctly trigger the signal and obtain a stable waveform.

Click or tap the **Level A/Level B** input field to set the level A/level B with the pop-up numeric keypad. You can also use the corresponding multipurpose knob to adjust level A/level B or use the trigger level knob to adjust level A. When **Linkage** is ticked, the upper limit and lower limit values change at the same time. The difference between upper and lower limit remains unchanged. For details, refer to *Trigger Level*. The current trigger level is displayed in the trigger information label at the top of the screen.

### Trigger Mode

In **Sweep**, select Auto, Normal, or Single as the trigger mode. For details, refer to *Trigger Mode*.

### Trigger Parameter Setting

You can refer to *Trigger Holdoff* and *Noise Rejection* to set the trigger holdoff and noise rejection under this trigger type.

## 8.7.10 Delay Trigger

In Delay trigger, you need to set Source A and Source B. The oscilloscope triggers when the time difference ( $\Delta T$ ) between the specified edges (Edge A and Edge B) of Source A and Source B meets the preset time limit, as shown in the figure below. Edge A and Edge B must be two neighboring edges.

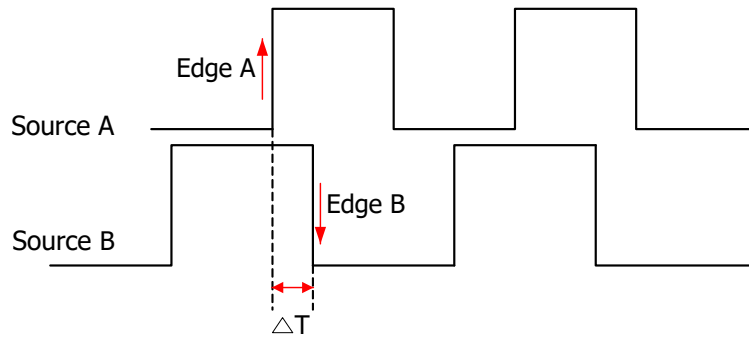

Figure 8.18 Delay Trigger

### Trigger Type

Click or tap the drop-down button of **Type** to select "Delay".

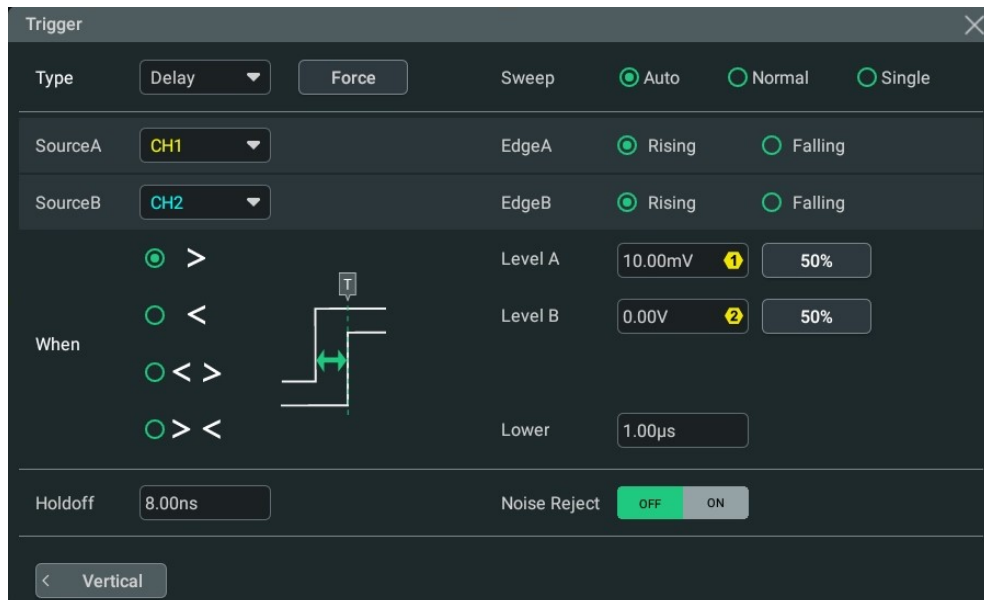

Figure 8.19 Delay Trigger Setting Menu

After a trigger type is selected, the current trigger setting information (including trigger type, trigger source, and trigger level) is displayed in the trigger information



label at the top of the screen, as shown in the figure below. The information will change based on the trigger settings.



### Source Setting

- **Source A:**

Click or tap the drop-down button of **SourceA** to select CH1-CH4. For details, refer to *Trigger Source*. The selected trigger source is indicated in the trigger information label at the top of the screen.

Only when you select the channel that has signal inputs as the trigger source, can you obtain a stable trigger.

- **Edge A:**

Select the trigger edge type ("Rising" or "Falling") of Source A in Delay trigger in the **EdgeA** item.

- **Source B:**

Click or tap the drop-down button of **SourceB** to select CH1-CH4. For details, refer to *Trigger Source*. The selected trigger source is indicated in the trigger information label at the top of the screen.

Only when you select the channel that has signal inputs as the trigger source, can you obtain a stable trigger.

- **Edge B:**

Select the trigger edge type ("Rising" or "Falling") of Source B in Delay trigger in the **EdgeB** item.

### Set the trigger condition

Sets the time limit condition of Delay trigger in the **When** item.

- **>**: triggers when the time difference ( $\Delta T$ ) between the specified edges of Source A and Source B is greater than the preset time lower limit. Click or tap the input field of **Lower** to set the delay time lower limit in Delay trigger with the pop-up numeric keypad. You can also use the corresponding multipurpose knob to set the value.
- **<**: triggers when the time difference ( $\Delta T$ ) between the specified edges of Source A and Source B is smaller than the preset time upper limit. Click or tap the input field of **Upper** to set the delay time upper limit in Delay trigger with the pop-up numeric keypad. You can also use the corresponding multipurpose knob to set the value.

- **< >**: triggers when the time difference ( $\Delta T$ ) between the specified edges of Source A and Source B is greater than the lower limit of the preset time and smaller than the upper limit of the preset time. Click or tap the input field of **Upper** to set the delay time upper limit in Delay trigger with the pop-up numeric keypad. Click or tap the input field of **Lower** to set the delay time lower limit in Delay trigger with the pop-up numeric keypad. You can also use the corresponding multipurpose knob to set the upper and lower limit. The lower time limit must be smaller than the upper time limit.
- **> <**: triggers when the time difference ( $\Delta T$ ) between the specified edges of Source A and Source B is smaller than the lower limit of the preset time or greater than the upper limit of the preset time. Click or tap the input field of **Upper** to set the delay time upper limit in Delay trigger with the pop-up numeric keypad. Click or tap the input field of **Lower** to set the delay time lower limit in Delay trigger with the pop-up numeric keypad. You can also use the corresponding multipurpose knob to set the upper and lower limit. The lower time limit must be smaller than the upper time limit.

### Level Selection and Setting

After the trigger condition setting is completed, you need to adjust the trigger level to correctly trigger the signal and obtain a stable waveform.

- **Level A:**

Click or tap the input field of **Level A** to input the level of Source A with the pop-up numeric keypad. You can also use the corresponding multipurpose knob or trigger level knob to set the value. For details, refer to descriptions in *Trigger Level*. The current trigger level is displayed in the trigger information label at the top of the screen.

- **Level B:**

Click or tap the input field of **Level B** to input the level of Source B with the pop-up numeric keypad. You can also use the corresponding multipurpose knob or trigger level knob to set the value. For details, refer to descriptions in *Trigger Level*. The current trigger level is displayed in the trigger information label at the top of the screen.

### Trigger Mode

In **Sweep**, select Auto, Normal, or Single as the trigger mode. For details, refer to *Trigger Mode*.

### Trigger Parameter Setting

You can refer to *Trigger Holdoff* and *Noise Rejection* to set the trigger holdoff and noise rejection under this trigger type.

## 8.7.11 Setup/Hold Trigger

In setup&hold trigger, you need to set the clock source and data source. The setup time starts when the data signal passes the trigger level and ends at the coming of the specified clock edge; the hold time starts at the coming of the specified clock edge and ends when the data signal crosses the trigger level again, as shown in the figure below. The oscilloscope triggers when the setup time or hold time is smaller than the preset time.

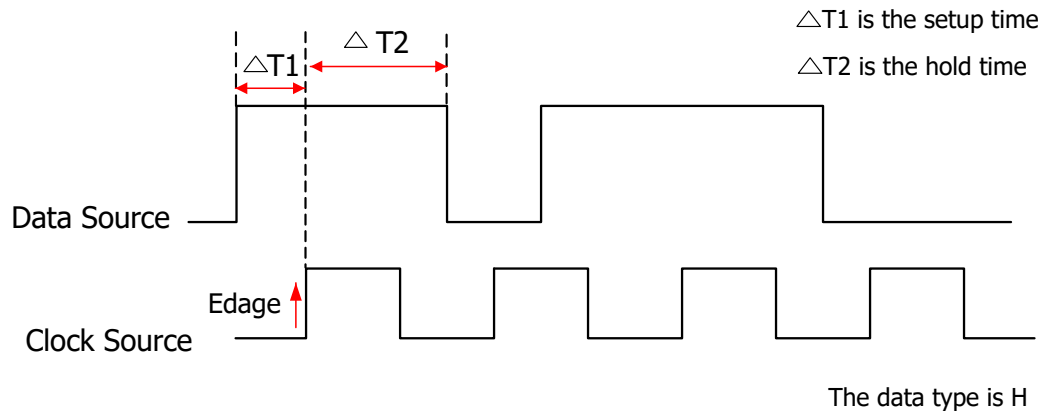

Figure 8.20 Setup/Hold Trigger

### Trigger Type

Click or tap the drop-down button of **Type** to select "Setup/Hold".

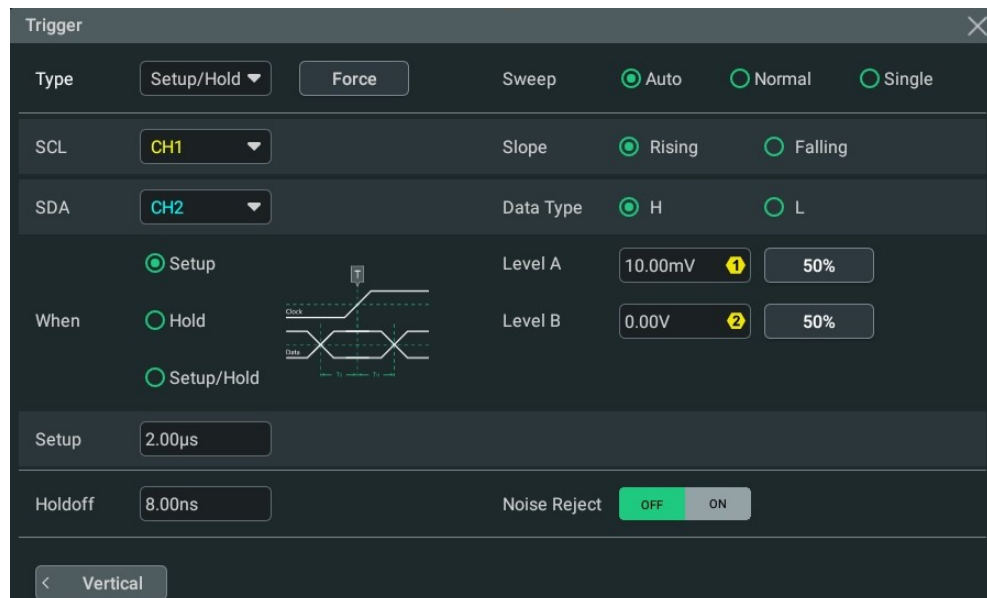

Figure 8.21 Setup/Hold Trigger Setting Menu

After a trigger type is selected, the current trigger setting information (including trigger type, trigger source, and trigger level) is displayed in the trigger information

label at the top of the screen, as shown in the figure below. The information will change based on the trigger settings.



### Clock Source

Click or tap the drop-down button of **SCL** to select CH1-CH4. For details, refer to descriptions in *Trigger Source*. The current trigger source is displayed in the trigger information label at the top of the screen.

Only when you select the channel that has signal inputs as the trigger source, can you obtain a stable trigger.

### Edge Type

Select the desired clock edge type in the **Slope** item, and it can be set to "Rising" or "Falling".

### Data Source

Click or tap the drop-down button of **SDA** to select CH1-CH4. For details, refer to descriptions in *Trigger Source*. The current trigger source is displayed in the trigger information label at the top of the screen.

Only when you select the channel that has signal inputs as the trigger source, can you obtain a stable trigger.

### Data Type

Select the effective pattern of the data signal in the **Data Type** item. It can be set to H (high level) or L (low level).

### Trigger Condition

Sets the Setup/Hold trigger condition in the **When** item.

- **Setup**: the oscilloscope triggers when the setup time is smaller than the specified setup time. After selecting this type, click or tap the input field of **Setup** to set the setup time with the pop-up numeric keypad. You can also use the corresponding multipurpose knob to set the value.
- **Hold**: the oscilloscope triggers when the hold time is smaller than the specified hold time. After selecting this type, click or tap the input field of **Hold** to set the hold time with the pop-up numeric keypad. You can also use the corresponding multipurpose knob to set the value.
- **Setup/Hold**: the oscilloscope triggers when the setup time or hold time smaller than the specified time value. After selecting this type, click or tap the input field of **Setup** and **Hold** respectively to set the setup and hold time with the pop-up

numeric keypad. You can also use the corresponding multipurpose knob to set the values.

### Trigger Mode

In **Sweep**, select Auto, Normal, or Single as the trigger mode. For details, refer to *Trigger Mode*.

### Trigger Parameter Setting

You can refer to *Trigger Holdoff* and *Noise Rejection* to set the trigger holdoff and noise rejection under this trigger type.

### Level Selection and Setting

After the trigger condition setting is completed, you need to adjust the trigger level to correctly trigger the signal and obtain a stable waveform.

- **Level A:**

Click or tap the input field of **Level A** to input the level of Source A with the pop-up numeric keypad. You can also use the corresponding multipurpose knob or trigger level knob to set the value. For details, refer to descriptions in *Trigger Level*. The current trigger level is displayed in the trigger information label at the top of the screen.

- **Level B:**

Click or tap the input field of **Level B** to input the level of Source B with the pop-up numeric keypad. You can also use the corresponding multipurpose knob or trigger level knob to set the value. For details, refer to descriptions in *Trigger Level*. The current trigger level is displayed in the trigger information label at the top of the screen.

## 8.7.12 Nth Edge Trigger

The Nth edge trigger lets you to trigger on the Nth edge that occurs after a specified idle time. For example, in the waveform as shown in the figure below, the instrument should trigger on the second rising edge after the specified idle time (the time between two neighboring rising edges), and the idle time should be within the range between P and M ( $P < \text{Idle Time} < M$ ). Wherein, M is the time between the first rising edge and its previous rising edge; P is the maximum time between the rising edges that participate in counting.

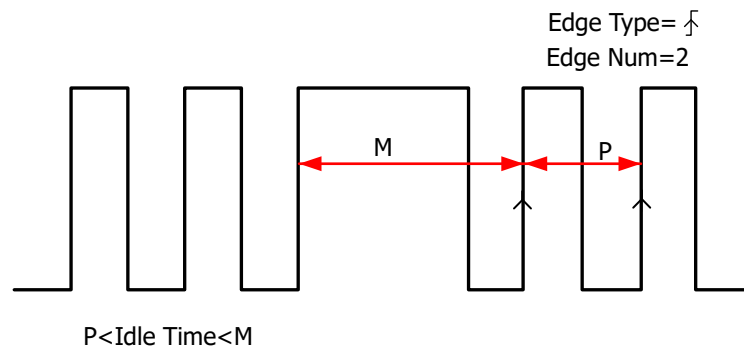

Figure 8.22 Nth Edge Trigger

### Trigger Type

Click or tap the drop-down button of **Type** to select "Nth Edge".

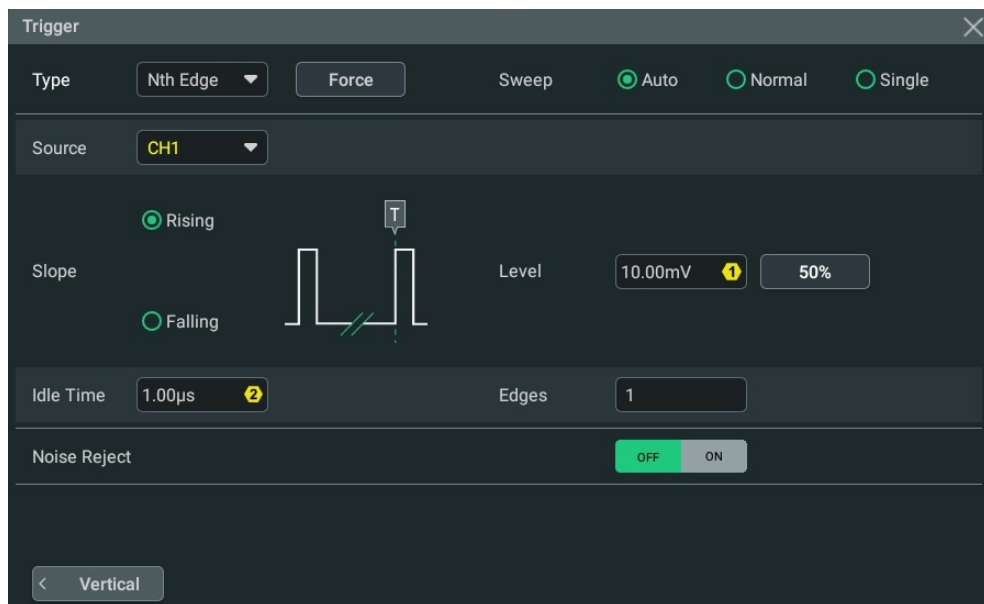

Figure 8.23 Nth Edge Trigger Setting Menu

After a trigger type is selected, the current trigger setting information (including trigger type, trigger source, and trigger level) is displayed in the trigger information label at the top of the screen, as shown in the figure below. The information will change based on the trigger settings.



### Source Selection

Click or tap the drop-down button of **Source** to select CH1-CH4. For details, refer to descriptions in *Trigger Source*. The current trigger source is displayed in the trigger information label at the top of the screen.

Only when you select the channel that has signal inputs as the trigger source, can you obtain a stable trigger.

### Edge Type

Select the input signal edge (in the **Slope** item) on which the oscilloscope triggers.

- Rising: triggers on the rising edge of the input signal when the voltage level meets the specified trigger level.
- Falling: triggers on the falling edge of the input signal when the voltage level meets the specified trigger level.

### Idle Time

Click or tap the input field of **Idle Time**, and then use the pop-up numeric keypad to set the idle time before the edge counting in Nth edge trigger. You can also use the corresponding multipurpose knob to set the value.

### Edge Count

Click or tap the input field of **Edges**, then use the pop-up numeric keypad to set the value of "N" in Nth edge trigger. You can also use the corresponding multipurpose knob to set the value. The available range is from 1 to 65,535.

### Trigger Mode

In **Sweep**, select Auto, Normal, or Single as the trigger mode. For details, refer to *Trigger Mode*.

### Trigger Parameter Setting

You can refer to *Noise Rejection* to set the noise rejection under this trigger type.

### Trigger Level

Click or tap the **Level** input field to set the trigger level with the pop-up numeric keypad. You can also use the front-panel trigger level knob or the corresponding multipurpose knob to set the trigger level. For details, refer to descriptions in *Trigger Level*. The current trigger level is displayed in the trigger information label at the top of the screen.

## 8.7.13 RS232 Trigger

RS232 bus is a serial communication mode used in data transmission between PCs or between a PC and a terminal. In RS232 serial protocol, a character is transmitted as a frame of data. The frame consists of 1 start bit, 5-8 data bits, 1 check bit, and 1-2 stop

bits. Its format is as shown in the figure below. This series oscilloscope triggers when detecting the start frame, error frame, check error, or the specified data of the RS232 signal.

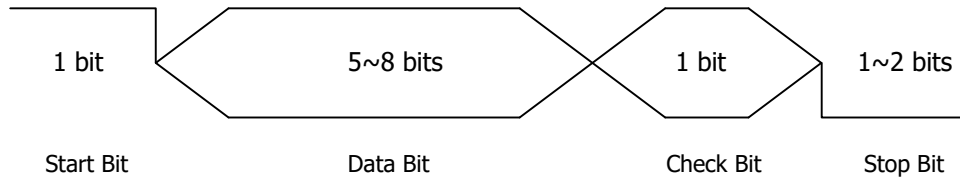

Figure 8.24 Schematic Diagram of RS232 Protocol

### Trigger Type

Click or tap the drop-down button of **Type** to select "RS232".

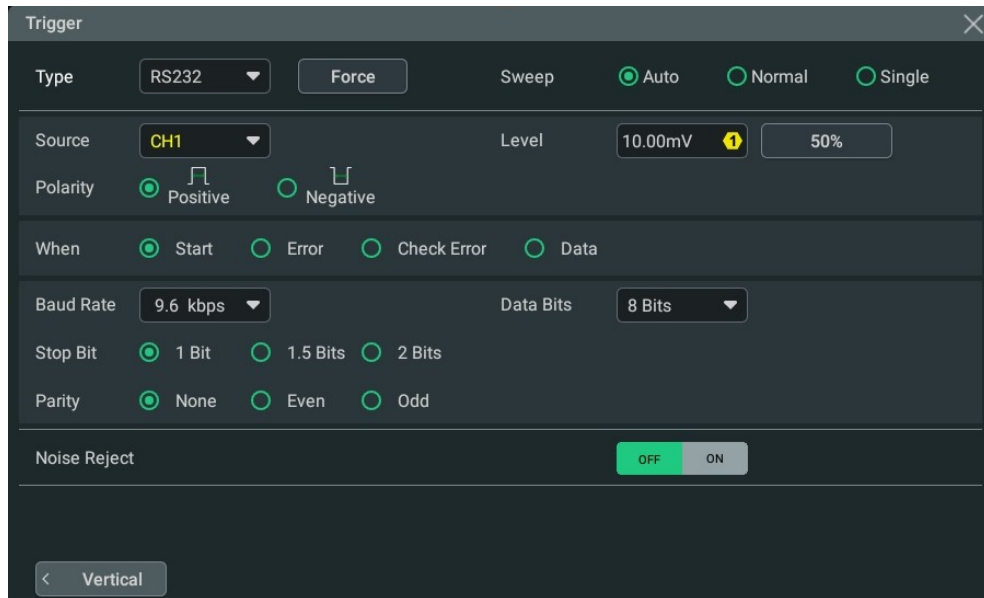
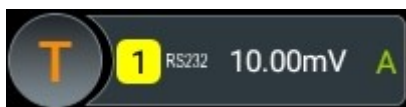

Figure 8.25 RS232 Trigger Setting Menu

After a trigger type is selected, the current trigger setting information (including trigger type, trigger source, and trigger level) is displayed in the trigger information label at the top of the screen, as shown in the figure below. The information will change based on the trigger settings.





### Source Selection

Click or tap the drop-down button of **Source** to select CH1-CH4. For details, refer to descriptions in *Trigger Source*. The current trigger source is displayed in the trigger information label at the top of the screen.

Only when you select the channel that has signal inputs as the trigger source, can you obtain a stable trigger.

### Polarity

Select the polarity of data transmission in the **Polarity** item. It can be set to "Positive"



or "Negative"

### Trigger Condition

Set the desired trigger condition in the **When** item.

- Start: triggers on the start frame position.
- Error: triggers when an error frame is detected.
- Check Error: triggers when a check error is detected.
- Data: triggers on the last bit of the preset data bits. Click or tap the input field of **Data**, and then use the pop-up numeric keypad to set the data of RS232 trigger. You can also use the corresponding multipurpose knob to set the value.

### Baud Rate

Set the baud rate of data transmission (i.e. specifies a clock frequency). Click or tap the drop-down button of **Baud Rate**, then select the preset baud rate. The available baud rates include 50 bps, 75 bps, 110 bps, 134 bps, 150 bps, 300 bps, and etc.

### Data Bits

Indicate the number of bits per frame. Click or tap the drop-down button of **Data Bits** to select the desired data bits. The available data bits include "5 Bits", "6 Bits", "7 Bits", and "8 Bits".

### Stop Bit

Indicates when to stop outputting data. Select the desired stop bit in the **Stop Bit** item. The available data bits include 1 Bit, 1.5 Bits, and 2 Bits.

### Parity

Used to check whether the data are properly transmitted. Select None, Even, or Odd in the **Parity** item.

### Trigger Mode

In **Sweep** item, select Auto, Normal, or Single as the trigger mode. For details, refer to descriptions in *Trigger Mode*.

### Trigger Parameter Setting

You can refer to *Noise Rejection* to set the noise rejection under this trigger type.

### Trigger Level

Click or tap the **Level** input field to set the trigger level with the pop-up numeric keypad. You can also use the front-panel trigger level knob or the corresponding multipurpose knob to set the trigger level. For details, refer to descriptions in *Trigger Level*. The current trigger level is displayed in the trigger information label at the top of the screen.

## 8.7.14 I2C Trigger

I2C is a 2-wire serial bus used to connect the microcontroller and its peripheral device. It is a bus standard widely used in the microelectronic communication control field.

The I2C serial bus consists of SCL and SDA. Its transmission rate is determined by SCL, and its transmission data is determined by SDA, as shown in the figure below. The instrument triggers on the start condition, restart, stop, missing acknowledgment, specific device address, or data value. Besides, it can also trigger on the specific device address and data values at the same time.

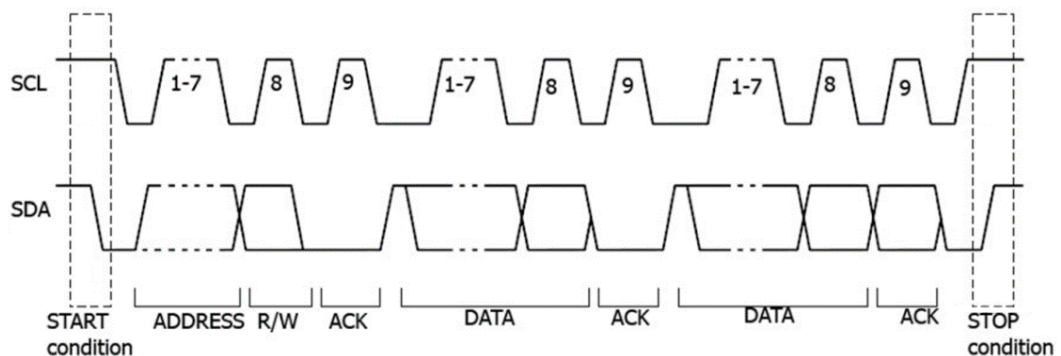
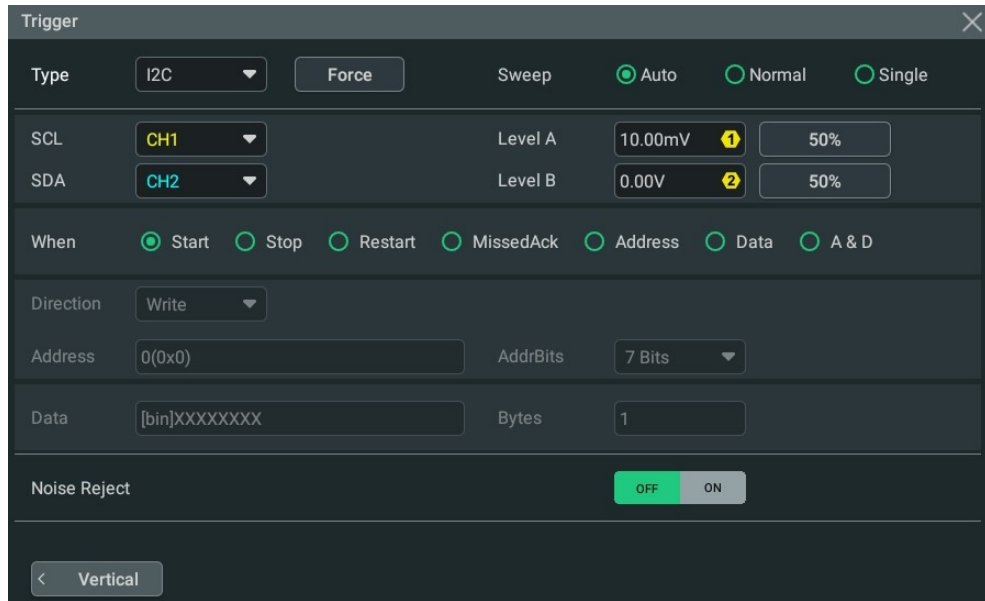

Figure 8.26 Schematic Diagram of I2C Protocol

### Trigger Type

Click or tap the drop-down button of **Type** to select "I2C".



**Figure 8.27 I2C Trigger Setting Menu**

After a trigger type is selected, the current trigger setting information (including trigger type, trigger source, and trigger level) is displayed in the trigger information label at the top of the screen, as shown in the figure below. The information will change based on the trigger settings.



### Source Selection

Click or tap the drop-down buttons of **SCL** and **SDA** to select CH1-CH4 to specify the sources of SCL and SDA respectively. For details, refer to descriptions in *Trigger Source*. The current trigger source is displayed in the trigger information label at the top of the screen.

Only when you select the channel that has signal inputs as the trigger source, can you obtain a stable trigger.

### Trigger Condition

Select the desired trigger condition in the **When** item.

- **Start:** triggers when SDA data transitions from high level to low level while SCL is high level.
- **Stop:** triggers when SDA data transitions from low level to high level while SCL is high level.
- **Restart:** triggers when another start condition occurs before a stop condition.

- **MissedAck:** triggers when the SDA data is high level during any acknowledgment of SCL clock position.
- **Address:** the trigger searches for the specified address value. When this event occurs, the oscilloscope will trigger on the read/write bit. After this trigger condition is selected:
  - Click or tap the drop-down button of **Direction** to select "Write", "Read", or "R/W".  
This setting is not available when **AddrBits** is set to "8 Bits".
  - Click or tap the drop-down button of **AddrBits** to select the desired address bits. The available address bits are "7 Bits", "8 Bits", and "10 Bits".
  - Click or tap the input field of **Address**, and then use the pop-up numeric keypad to set the address of I2C trigger. You can also use the corresponding multipurpose knob to set the value.
- **Data:** the trigger searches for the specified data value on the data line (SDA). When this event occurs, the oscilloscope will trigger on the clock line (SCL) transition edge of the last bit of data. After this trigger condition is selected, you can set the length of bytes and data format.
  - Click or tap the input field of **Bytes**, and then use the pop-up numeric keypad to set the length of the data. You can also use the corresponding multipurpose knob to set the value. Its range is from 1 to 5.
  - Click or tap the input field of **Data**, and then the "Format" interface is will displayed. As shown in the figure below, you can select "Bin" or "Hex" data format.

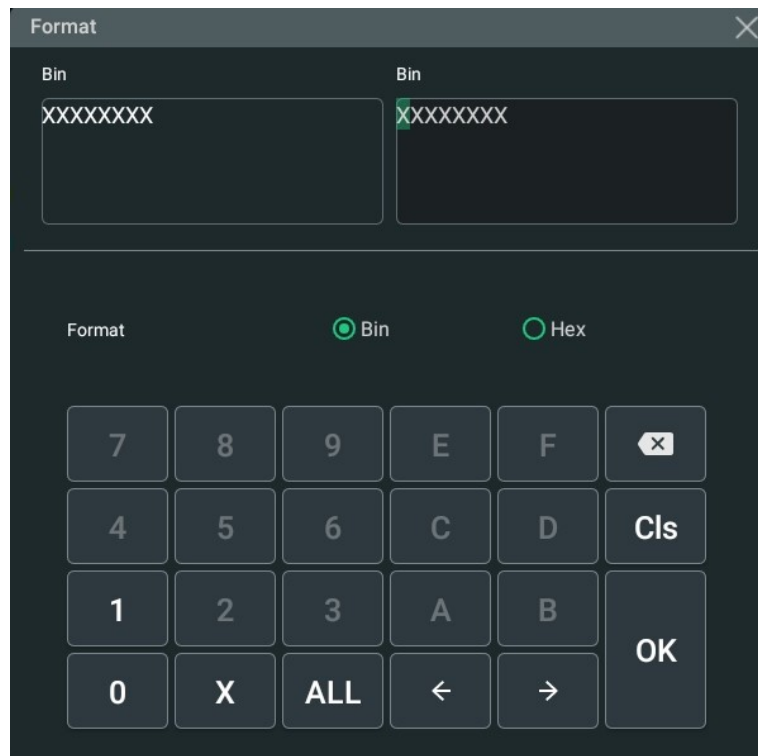

Figure 8.28 Bin Format Setting

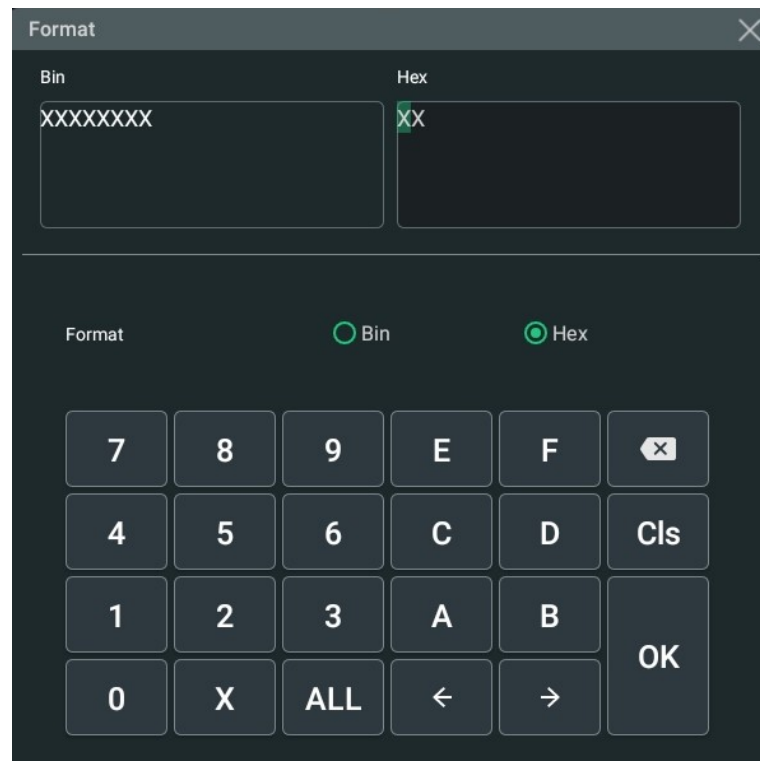

Figure 8.29 Hex Format Setting

- **A&D:** the oscilloscope searches for the specified address and data at the same time, then triggers when both the address and data meet the conditions. After this condition is selected, you need to set the sub-menu items such as **Direction**, **Bytes**, **AddrBits**, **Address**, and **Data**. For the setting methods, refer to descriptions in "Address" and "Data" conditions.

### Trigger Mode

In **Sweep**, select Auto, Normal, or Single as the trigger mode. For details, refer to *Trigger Mode*.

### Trigger Parameter Setting

You can refer to *Noise Rejection* to set the noise rejection under this trigger type.

### Level Selection and Setting

After the trigger condition setting is completed, you need to adjust the trigger level to correctly trigger the signal and obtain a stable waveform.

- **Level A**

Click or tap the input field of **Level A** to input the level of SCL with the pop-up numeric keypad. You can also use the corresponding multipurpose knob or trigger level knob to set the value. For details, refer to descriptions in *Trigger Level*. The current trigger level is displayed in the trigger information label at the top of the screen.

- **Level B**

Click or tap the input field of **Level B** to input the level of SDA with the pop-up numeric keypad. You can also use the corresponding multipurpose knob to set the value. For details, refer to descriptions in *Trigger Level*. The current trigger level is displayed in the trigger information label at the top of the screen.

### 8.7.15 SPI Trigger

In SPI trigger, after the CS or timeout condition is satisfied, the oscilloscope triggers when the specified data is found. When using SPI trigger, you need to specify the CLK clock sources and MISO data sources.

The figure below shows the sequential chart of SPI bus.

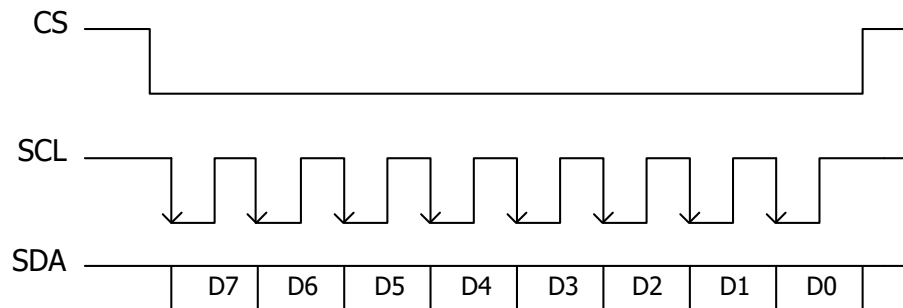

Figure 8.30 Sequential Chart of SPI Bus

#### Trigger Type

Click or tap the drop-down button of **Type** to select "SPI".

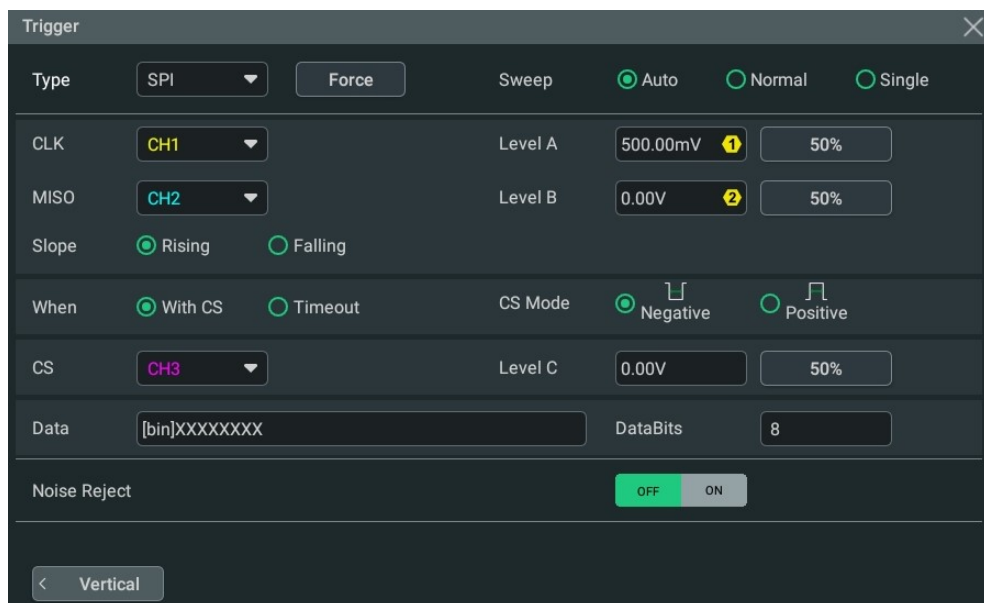
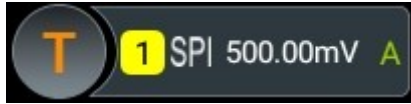

Figure 8.31 SPI Trigger Setting Menu

After a trigger type is selected, the current trigger setting information (including trigger type, trigger source, and trigger level) is displayed in the trigger information label at the top of the screen, as shown in the figure below. The information will change based on the trigger settings.



### Source Selection

Click or tap the drop-down buttons of **CLK** and **MISO** to select CH1-CH4 to specify the sources of CLK and MISO respectively. For details, refer to descriptions in *Trigger Source*. The current trigger source is displayed in the trigger information label at the top of the screen.

Only when you select the channel that has signal inputs as the trigger source, can you obtain a stable trigger.

### Edge Type

Select the desired clock edge type in **Slope**.

- Rising: samples the MISO data on the rising edge of the clock.
- Falling: samples the MISO data on the falling edge of the clock.

### Trigger Condition

Select the desired trigger condition in **When**.

- With CS: if the CS signal is valid, the oscilloscope will trigger when the data (SDA) satisfying the trigger conditions is found.
  - Click or tap the drop-down button of **CS** to select CH1-CH4 as the CS signal line.
  - After selecting this condition, you can click or tap "Positive" (high level is valid) or "Negative" (low level is valid) in **CS Mode**.
- Timeout: the oscilloscope starts to search for the data (MISO) on which to trigger after the clock signal (CLK) stays in the idle state for a specified period of time. After selecting this condition, you can click or tap **Timeout**, then use the numeric keypad to set the idle time. You can also use the corresponding multipurpose knob to set the value. The range is from 8 ns to 10 s.

### Data

Click or tap the of field of **Data**, and then the "Format" interface is displayed. You can set the data bit that needs to be operated on. For details, refer to descriptions in *I2C Trigger*.

### Data Bits

Click or tap the input field of **DataBits**, and then use the pop-up numeric keypad to set the number of bits in the serial data string. You can also use the corresponding multipurpose knob to set the value. The number of bits in the string can be set to any integer ranging from 4 to 32.

### Trigger Mode

In **Sweep**, select Auto, Normal, or Single as the trigger mode. For details, refer to *Trigger Mode*.

### Trigger Parameter Setting

You can refer to *Noise Rejection* to set the noise rejection under this trigger type.

### Level Selection and Setting

After the trigger condition setting is completed, you need to adjust the trigger level to correctly trigger the signal and obtain a stable waveform.

- **Level A**

Click or tap the input field of **Level A** to input the level of CLK with the pop-up numeric keypad. You can also use the corresponding multipurpose knob or the trigger level knob to adjust the level of CLK. For details, refer to descriptions in *Trigger Level*. The current trigger level is displayed in the trigger information label at the top of the screen.

- **Level B**

Click or tap the input field of **Level B** to input the level of MISO with the pop-up numeric keypad. You can also use the corresponding multipurpose knob to adjust the level of MISO. For details, refer to descriptions in *Trigger Level*. The current trigger level is displayed in the trigger information label at the top of the screen.

- **Level C**

Click or tap the input field of **Level C** to input the level of CS with the pop-up numeric keypad. You can also use the corresponding multipurpose knob to adjust the level of CS. For details, refer to descriptions in *Trigger Level*. The current trigger level is displayed in the trigger information label at the top of the screen.

## 8.7.16 CAN Trigger

This series oscilloscope can trigger on the start of a frame, end of a frame, frame of the specified type (e.g. Remote, Overload, Data, etc.), or error frame of the specified type (e.g. Answer Error, Check Error, Format Error, etc.) of the CAN signal.

The data frame format of the CAN bus is as shown in the figure below.



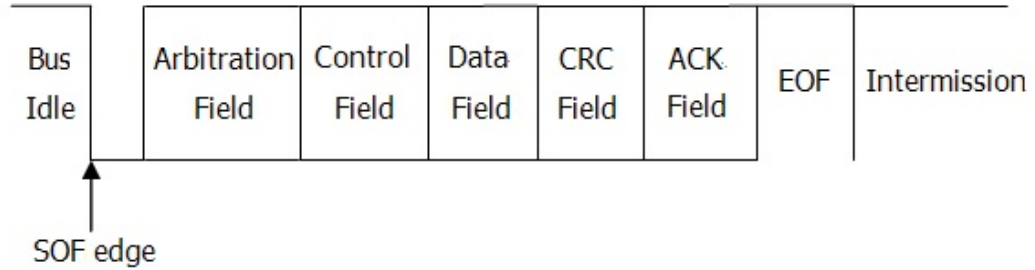

Figure 8.32 Data Frame Format of the CAN Bus

### Trigger Type

Click or tap the drop-down button of **Type** to select "CAN".

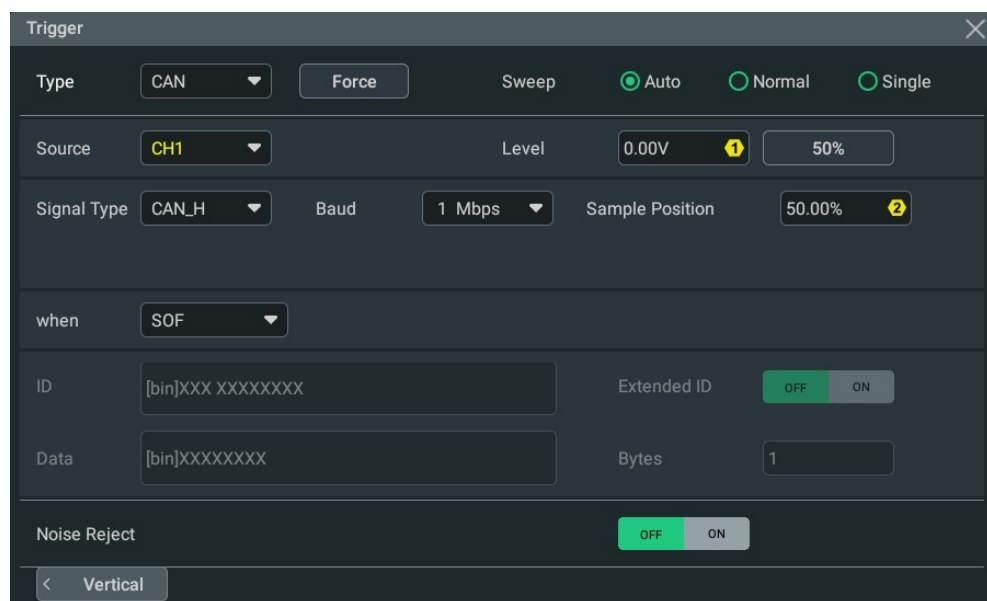

Figure 8.33 CAN Trigger Setting Menu

After a trigger type is selected, the current trigger setting information (including trigger type, trigger source, and trigger level) is displayed in the trigger information label at the top of the screen, as shown in the figure below. The information will change based on the trigger settings.



### Source Selection

Click or tap the drop-down button of **Source** to select CH1-CH4. For details, refer to descriptions in *Trigger Source*. The current trigger source is displayed in the trigger information label at the top of the screen.

Only when you select the channel that has signal inputs as the trigger source, can you obtain a stable trigger.

### Signal Type

Click or tap the drop-down button of **Signal Type** to select the desired signal type.

- CAN\_H: indicates the actual CAN\_H bus signal.
- CAN\_L: indicates the actual CAN\_L bus signal.
- TX/RX: indicates the Transmit signal and Receive signal from the CAN bus transceiver.
- DIFF: indicates the CAN differential bus signals connected to an analog channel by using a differential probe. Connect the probe's positive lead to the CAN\_H bus signal and connect the negative lead to the CAN\_L bus signal.

### Baud Rate

Click or tap the drop-down button of **Baud** to select the preset baud rate. The available baud rates include 10 kbps, 20 kbps, 33.3 kbps, 50 kbps, 62.5 kbps, 83.3 kbps, and etc.

### Sample Position

Sample position is a point within a bit's time. The oscilloscope samples the bit level at this point. The sample position is represented by the proportion of "the time from the start of the bit to the sample position" to the "bit time", as shown in the figure below.

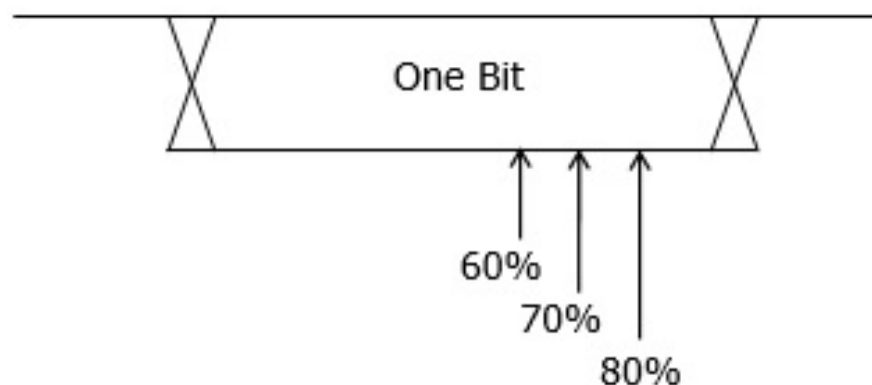

Figure 8.34 Sample Position

Click or tap the input field of **Sample Position** to set it by using the pop-up numeric keypad. You can also use the corresponding multipurpose knob to set the value. The settable range is from 10% to 90%.

## Trigger Condition

Click or tap the drop-down button of **When** to select the desired trigger condition.

- SOF: triggers at the start of a frame.
- EOF: triggers at the end of a frame.
- Remote ID: triggers on the specified ID of Remote frame. When you select **Remote ID**, you need to set the following parameters.
  - Click or tap the **Extended ID** on/off switch to enable or disable the extended ID.
  - Click or tap the input field of **Data**, and then the "Format" interface is displayed. You can set the data bit that needs to be operated on. For details, refer to descriptions in *I2C Trigger (Option)*.
- Overload: triggers on the overload frames.
- Frame ID: triggers on the data frames with the specified ID. After you select **Frame ID**, you can refer to the "Remote ID" mentioned above to set the **Extended ID** and **ID**.
- Frame Data: triggers on the data frames with the specified Data. When you select **Frame Data**, you need to set the following parameters.
  - Click or tap the input field of **Data**, and then the "Format" interface is displayed. You can set the data bit that needs to be operated on. For details, refer to descriptions in *I2C Trigger (Option)*.
  - Click or tap the input field of **Bytes** and use the pop-up numeric keypad to set the value. You can also use the corresponding numeric keypad to set the value. The range is from 1 to 8.
- Data & ID: triggers on the data frames with the specified ID and data. When you select **Data & ID**, you need to set the **ID**, **Data**, and **Bytes**.
- Frame Error: triggers on the error frame.
- Bit Fill: triggers on the error frame with the bit fill.
- Answer Error: triggers on the answer error frame.
- Check Error: triggers on the check error frame.
- Format Error: triggers on the format error frame.
- Random Error: triggers on the random error frame, such as the format error frame, answer error frame, etc.

## Trigger Mode

In **Sweep**, select Auto, Normal, or Single as the trigger mode. For details, refer to *Trigger Mode*.

### Trigger Parameter Setting

You can refer to *Noise Rejection* to set the noise rejection under this trigger type.

### Trigger Level

Click or tap the **Level** input field to set the trigger level with the pop-up numeric keypad. You can also use the front-panel trigger level knob or the corresponding multipurpose knob to set the trigger level. For details, refer to descriptions in *Trigger Level*. The current trigger level is displayed in the trigger information label at the top of the screen.

## 8.7.17 LIN Trigger

This series can trigger on the sync field of LIN signal, and can also trigger on the specified identifier, data, or frame.

The data frame format of the LIN bus is as shown in the figure below.

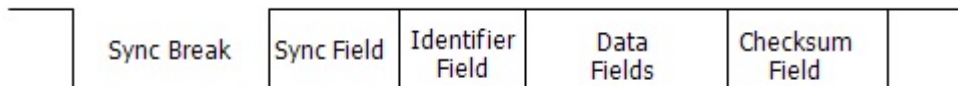

Figure 8.35 Data Frame Format of the LIN Bus

### Trigger Type

Click or tap the drop-down button of **Type** to select "LIN".

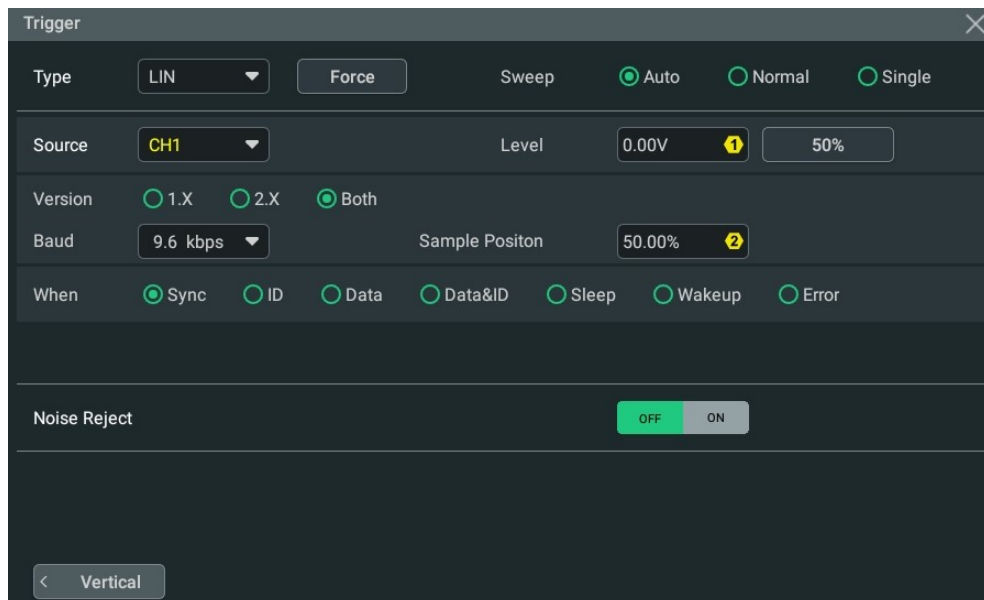

Figure 8.36 LIN Trigger Setting Menu

After a trigger type is selected, the current trigger setting information (including trigger type, trigger source, and trigger level) is displayed in the trigger information

label at the top of the screen, as shown in the figure below. The information will change based on the trigger settings.



### Source Selection

Click or tap the drop-down button of **Source** to select CH1-CH4. For details, refer to descriptions in *Trigger Source*. The current trigger source is displayed in the trigger information label at the top of the screen.

Only when you select the channel that has signal inputs as the trigger source, can you obtain a stable trigger.

### Protocol Version

In **Version**, select the protocol version that matches the signal under test. The available versions include 1.X, 2.X and Both.

### Baud Rate

Click or tap the drop-down button of **Baud** to select the preset baud rate. The available baud rates include 1.2 kbps, 2.4 kbps, 4.8 kbps, 9.6 kbps, 19.2 kbps, and etc.

### Sample Position

Sample position is a point within a bit's time. The oscilloscope samples the bit level at this point. The sample position is represented by the proportion of "the time from the start of the bit to the sample position" to the "bit time", as shown in the figure below.

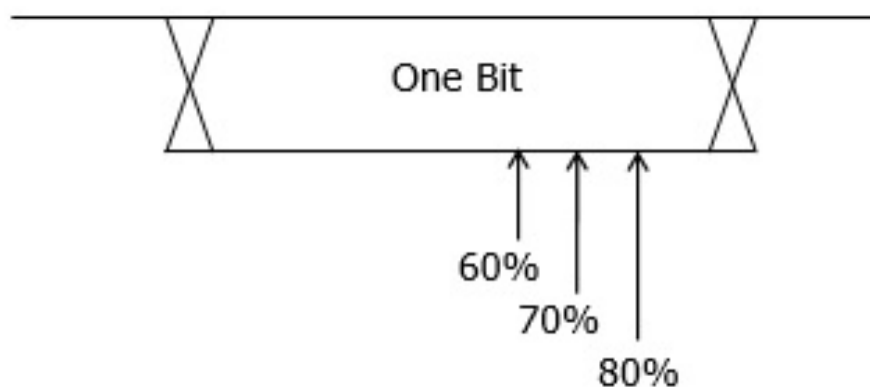

Figure 8.37 Sample Position

Click or tap the input field of **Sample Position** to set it by using the pop-up numeric keypad. You can also use the corresponding multipurpose knob to set the value. The settable range is from 10% to 90%.

## Trigger Condition

Click or tap the drop-down button of **When** to select the desired trigger condition.

- **Sync:** triggers on the last bit of the sync field.
- **ID:** triggers when the frames with the specified ID are found.

Click or tap the input field of **ID**, and then use the pop-up numeric keypad to set ID. You can also use the corresponding multipurpose knob to set the value.

- **Data:** triggers when the data that meet the preset conditions are found.
  - Click or tap the input field of **Data**, and then the "Format" interface is displayed. You can set the data bit that needs to be operated on. For details, refer to descriptions in *I2C Trigger*.
  - Click or tap the input field of **Bytes**, and then use the pop-up numeric keypad to set the length of the data. You can also use the corresponding multipurpose knob to set the value. Its range is from 1 to 8.
- **Data&ID:** triggers when the frames with the specified ID and data that meet the preset conditions are both found.

When **Data&ID** is selected, you need to set the **Data**, **Bytes**, and **ID**.

- **Sleep:** triggers when the sleep frame is found.
- **Wakeup:** triggers when the wakeup frame is found.
- **Error:** triggers on the specified type of error frame. Click or tap the drop-down button of **Error Type** to select the error type: Sync, Even Odd, or Check Sum.

## Trigger Mode

In **Sweep**, select Auto, Normal, or Single as the trigger mode. For details, refer to *Trigger Mode*.

## Trigger Parameter Setting

You can refer to *Noise Rejection* to set the noise rejection under this trigger type.

## Trigger Level

Click or tap the **Level** input field to set the trigger level with the pop-up numeric keypad. You can also use the front-panel trigger level knob or the corresponding multipurpose knob to set the trigger level. For details, refer to descriptions in *Trigger Level*. The current trigger level is displayed in the trigger information label at the top of the screen.

## 8.8 Trigger Output Connector

The rear-panel trigger output connector (**[AUX OUT]**) of this series can output trigger signals determined by the current setting (hardware trigger).

Click or tap  > **Utility**. Click or tap **Setup**, and then select "TrigOut" in **Aux Out**. A signal which reflects the current oscilloscope capture rate can be output from **[AUX OUT]** connector each time a trigger is generated by the oscilloscope. If this signal is connected to a waveform display device to measure the frequency, the measurement result is the same as the current capture rate.

If "PassFail" is selected in **Aux Out**, the instrument can output a pulse from the **[AUX OUT]** connector when a pass/failed event is detected during the pass/fail test.

## 9 Math Operation

This series oscilloscopes can realize multiple math operations between waveforms of different channels, including arithmetic operation, spectrum operation, logic operation, function operation, and digital filter. You can access the **Math** menu in the following ways.

- Click or tap the function navigation icon  at the lower-left corner of the screen, and then select **Math** to enter the "Math" menu.
- Click or tap the **Math** button in the Toolbar at the upper-right corner of the screen to enter the "Math" menu.
- Click or tap the Math1~Math4 label at the bottom of the screen, and the corresponding math window appears on the screen, as shown in *Figure 9.2*.

Click or tap the label again, or the  icon at the upper-right corner of the window to enter the "Math" menu.

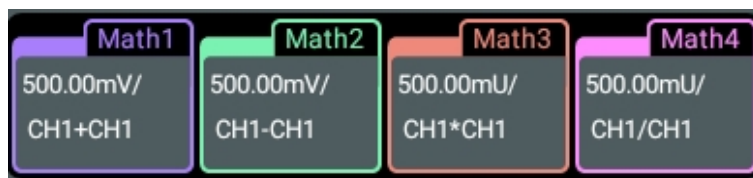

- Press the front-panel  key to enter the "Math" menu.

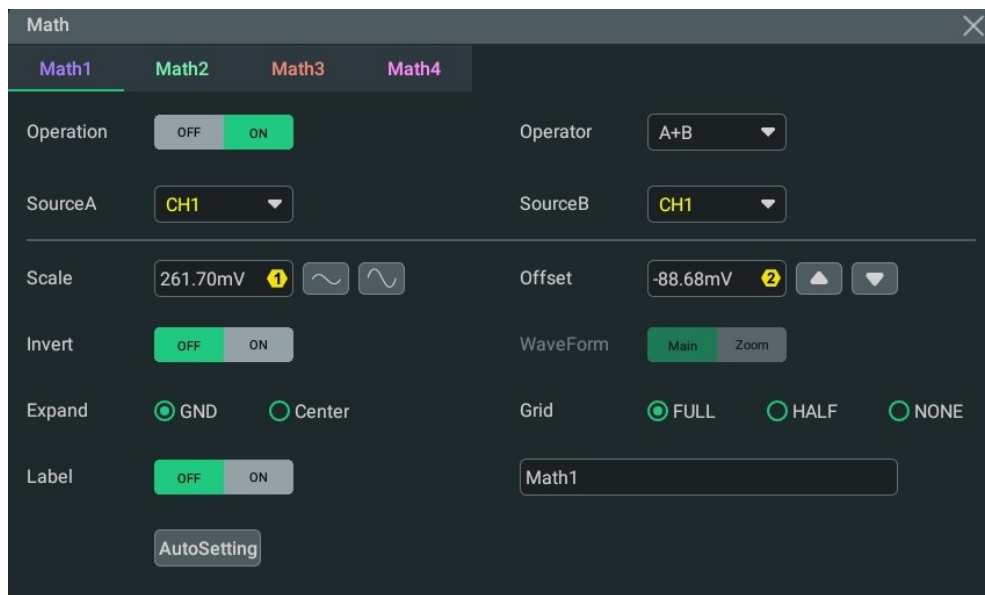

**Figure 9.1 Math Menu**

This oscilloscope provides four math operations: Math1, Math2, Math3, and Math4. You can select the desired math operation type by clicking or tapping the



**Math1**~**Math4** label or by sliding the menu left and right. This manual takes Math1 as an example to introduce math operation.

In the **Math** menu, click or tap the **Operation** on/off switch to show or hide the waveform display window of the operation results. By default, it is OFF. When "ON" is selected for Math1 ~ Math4, the figure as shown in *Figure 9.2* is displayed on the screen.

**Figure 9.2 Waveform Display Window of the Operation Results**

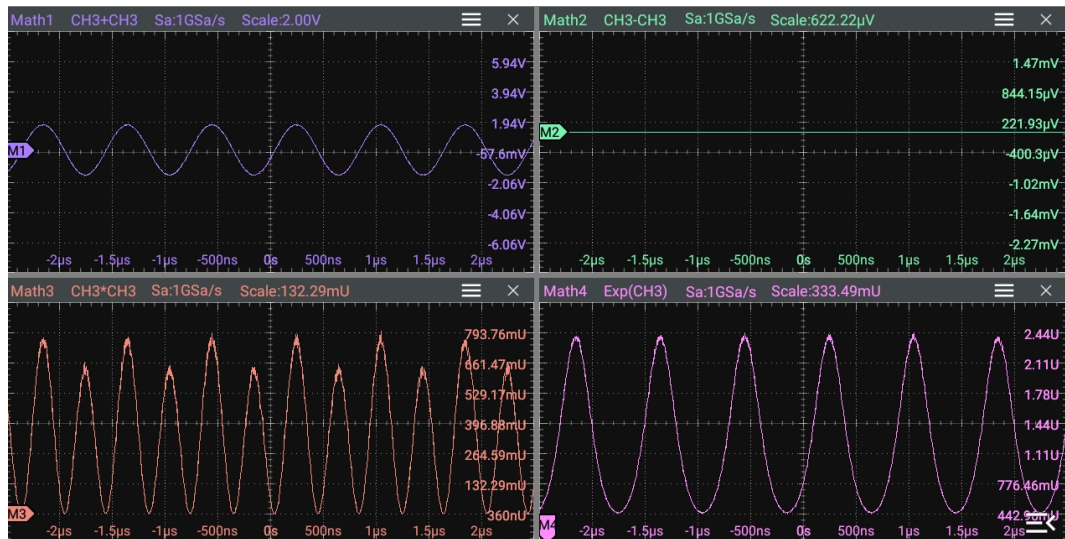

You can drag the title bar of the display window to change the position of the window. You can also click or tap  at the upper-right corner of the window to close it.

## 9.1 Arithmetic Operation

In the **Math** menu, click or tap the **Operator** drop-down button to select the desired math operation. The arithmetic operations supported by this oscilloscope include  $A+B$ ,  $A-B$ ,  $A \times B$ , and  $A \div B$ .

- **$A+B$**  adds the waveform voltage values of signal source A and B point by point and displays the results.
- **$A-B$**  subtracts the waveform voltage values of signal source B from that of source A point by point and displays the results.
- **$A \times B$**  multiplies the waveform voltage values of signal source A and B point by point and displays the results.
- **$A \div B$**  divides the waveform voltage values of signal source A by that of source B point by point and displays the results. It can be used to analyze the Multiple relation of the two channels waveforms.



**TIP**

When the voltage of signal source B is 0 V, the division result is treated as 0.

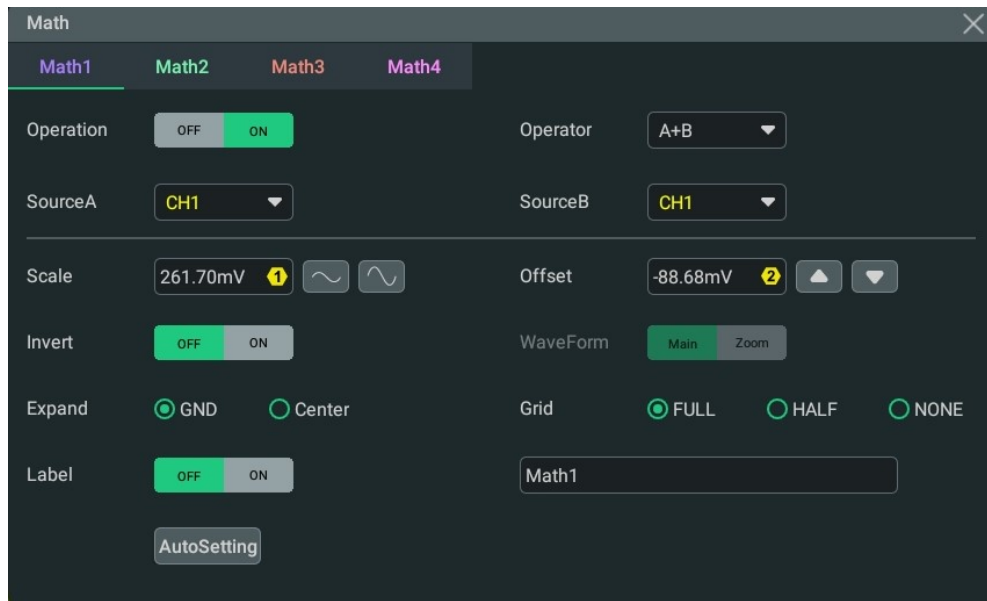
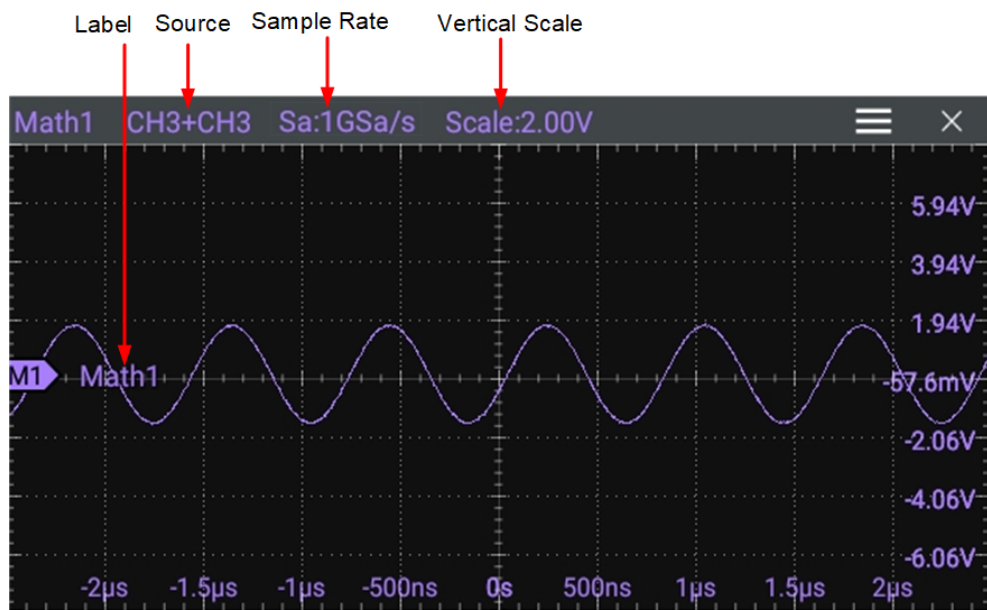

**Figure 9.3 Arithmetic Operation Menu**

**Operation Result Display Window**

Click or tap the **Operation** on/off switch to enable the display of the arithmetic operation result window. The source and the vertical scale parameters are displayed at the top of the window, as shown in the figure below.

**Figure 9.4 Operation Result Display Window**



### Source

Click or tap the drop-down button of **SourceA** or **SourceB** to select CH1, CH2, CH3, or CH4. When a source channel is selected, the selected channel automatically switches to the ON state.

### Scale

Scale is used to set the vertical scale of the operation result. You can set the vertical scale in the following ways.

- In **Vertical** menu, rotate the corresponding multipurpose knob on the front panel or click or tap the icon at the right side of the input field of **Scale** to increase or decrease the scale value. You can also click or tap the input field to input a specific value with the displayed numeric keypad.
- Close the menu and then adjust the vertical scale with the pinch & stretch gesture on the touch screen. You can also rotate the corresponding multipurpose knob on the front panel to adjust the vertical scale. Please refer to *Front Panel Overview* to configure the front-panel multipurpose knobs.

### Offset

Offset is used to set the vertical offset of the operation result. You can set the vertical offset in the following ways.

- In **Vertical** menu, rotate the corresponding multipurpose knob on the front panel or click or tap the icon at the right side of the input field of **Offset** to increase or decrease the scale value. You can also click or tap the input field to input a specific value with the displayed numeric keypad.
- Close the menu and then adjust the vertical offset with the drag gesture on the touch screen. You can also rotate the corresponding multipurpose knob on the front panel to adjust the vertical offset. Please refer to *Front Panel Overview* to configure the front-panel multipurpose knobs.

### Invert

Invert is used to enable or disable the inverted display of the waveform. For setting methods, refer to descriptions in *To Invert a Waveform*.

### Waveform

This oscilloscope supports Main (default) and Zoom.

- **Main** indicates that the measurement range is within the main time base region.
- **Zoom** indicates that the measurement range is within the zoomed time base region.

To use "Zoom", first enable the *Zoom Mode (Delayed Sweep)* in the Horizontal menu (*Horizontal System*).

### Expand

The oscilloscope supports two vertical expansion modes: GND (default) and Center.

- **GND:** When the vertical scale is changed, the math operation waveform will expand or compress about the ground level of the signal.
- **Center:** When the vertical scale is changed, the math operation waveform will expand or compress about the center of the display.

### Auto Set

Click or tap **AutoSetting** to adjust the vertical scale and the offset of the operation results to the optimal value according to the current configuration for you to better observe.

### Label

It is used to set the label for the math operation results. For setting methods, refer to descriptions in *To Turn the Channel Label Display On/Off*.

### Grid

For setting methods, refer to the descriptions in *To Set the Screen Grid*.

## 9.2 Function Operation

In the **Math** menu, click or tap the **Operator** drop-down button to select the desired function operation. The available function operation types of this oscilloscope include Intg, Diff, Sqrt, Lg (Base 10 Exponential), Ln, Exp, Abs, and AX+B.

- **Intg:** calculates the integral of the selected source. For example, you can use integral to measure the area under a waveform or the pulse energy.
- **Diff:** calculates the discrete time derivative of the selected source. For example, you can use differentiate to measure the instantaneous slope of a waveform.
- **Sqrt:** calculates the square roots of the selected source point by point and displays the results.
- **Lg (Base 10 Exponential):** calculates the base 10 exponential of the selected source point by point and displays the results.
- **Ln:** calculates the natural logarithm (Ln) of the selected source point by point and displays the results.
- **Exp:** calculates the exponential of the selected source point by point and displays the results.
- **Abs:** calculates the absolute value of the selected source and displays the results.
- **AX+B:** applies a linear function to the selected source, and displays the results.

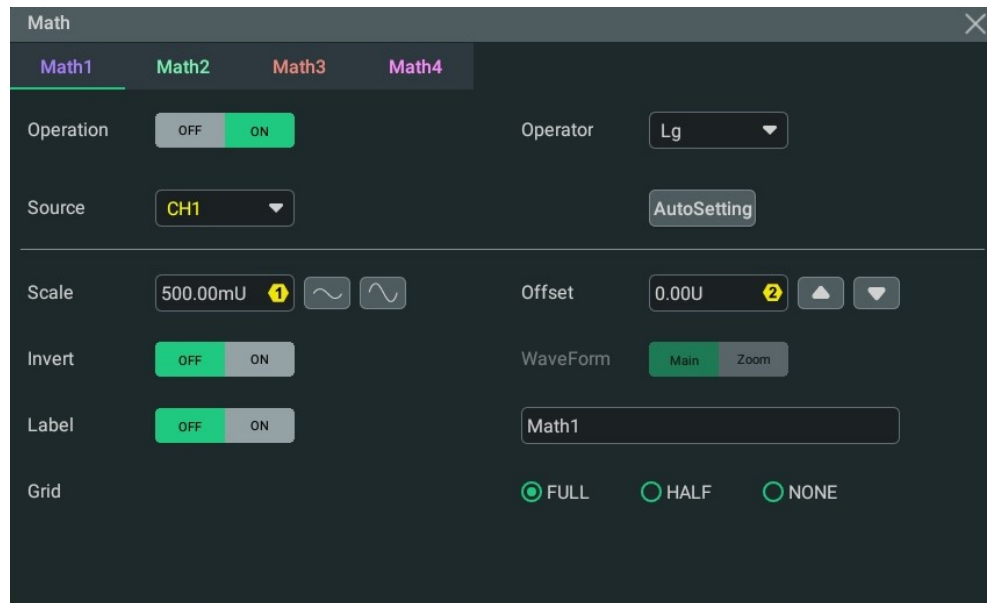

Figure 9.5 Function Operation Menu

### Operation Result Display Window

Click or tap the **Operation** on/off switch to enable or disable the display of the operation result window. The source and the vertical scale parameters are displayed at the top of the window, as shown in the figure below.

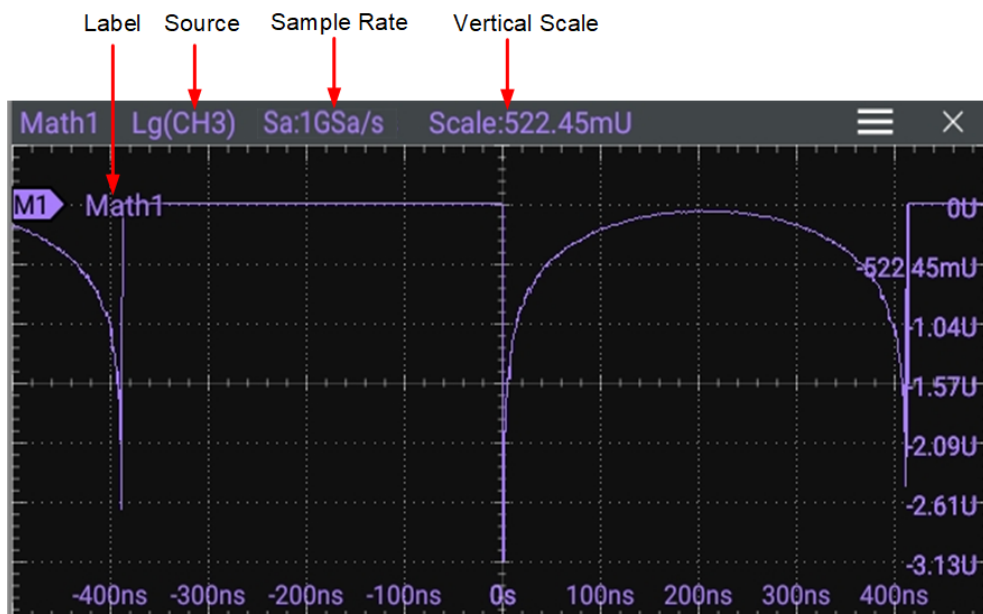

Figure 9.6 Operation Result Display Window

### Source

Click the **Source** drop-down button to select the source as CH1, CH2, CH3, and CH4. When a source channel is selected, the selected channel automatically switches to the ON state.

### Auto Set

Click or tap **AutoSetting** to adjust the vertical scale and the offset of the operation results to the optimal value according to the current configuration for you to better observe.

### Scale

Scale is used to set the vertical scale of the operation result. You can set the vertical scale in the following ways.

- In **Vertical** menu, rotate the corresponding multipurpose knob on the front panel or click or tap the icon at the right side of the input field of **Scale** to increase or decrease the scale value. You can also click or tap the input field to input a specific value with the displayed numeric keypad.
- Close the menu and then adjust the vertical scale with the pinch & stretch gesture on the touch screen. You can also rotate the corresponding multipurpose knob on the front panel to adjust the vertical scale. Please refer to *Front Panel Overview* to configure the front-panel multipurpose knobs.

### Offset

Offset is used to set the vertical offset of the operation result. You can set the vertical offset in the following ways.

- In **Vertical** menu, rotate the corresponding multipurpose knob on the front panel or click or tap the icon at the right side of the input field of **Offset** to increase or decrease the scale value. You can also click or tap the input field to input a specific value with the displayed numeric keypad.
- Close the menu and then adjust the vertical offset with the drag gesture on the touch screen. You can also rotate the corresponding multipurpose knob on the front panel to adjust the vertical offset. Please refer to *Front Panel Overview* to configure the front-panel multipurpose knobs.

### Invert

Invert is used to enable or disable the inverted display of the waveform. For setting methods, refer to descriptions in *To Invert a Waveform*.

### Waveform

This oscilloscope supports Main (default) and Zoom.

- **Main** indicates that the measurement range is within the main time base region.

- **Zoom** indicates that the measurement range is within the zoomed time base region.

To use "Zoom", first enable the *Zoom Mode (Delayed Sweep)* in the Horizontal menu (*Horizontal System*).

### Label

It is used to set the label for the math operation results. For setting methods, refer to descriptions in *To Turn the Channel Label Display On/Off*.

### Grid

For setting methods, refer to the descriptions in *To Set the Screen Grid*.

### Parameter Setting

- When the operator is "Intg", click or tap the **Offset** input field and use the pop-up numeric keypad to set the DC offset calibration factor of the input signal. You can also use the corresponding multipurpose knob to set the value.
- When the operator is "Diff", click or tap **Smooth** input field and use the pop-up numeric keypad to set the number of smooth times for the differential operation. You can also use the corresponding multipurpose knob to set the value.

## 9.3 FFT Operation

FFT (Fast Fourier Transform) is used to transform time-domain signals to frequency-domain components (frequency spectrum). This oscilloscope provides FFT operation function which enables you to observe the time-domain waveform and spectrum of the signal at the same time. FFT operation can facilitate the following works:

- Measure harmonic components and distortion in the system;
- Display the characteristics of the noise in DC power;
- Analyze vibration.

In the **Math** menu, click or tap the **Operator** drop-down button to select **FFT** to access the menu as shown in *Figure 9.7*.

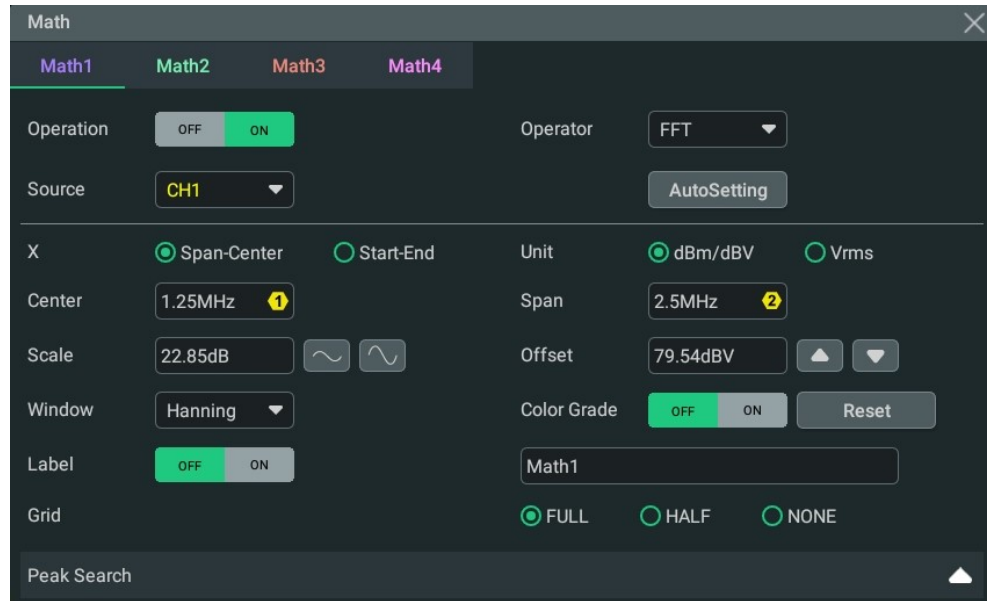

Figure 9.7 FFT Operation Menu

### Operation

Click or tap the **Operation** on/off switch to enable or disable the FFT operation result window. The parameters such as center frequency, frequency range, and resolution are displayed at the top of the window, as shown in the figure below. FFT resolution is the quotient of the sample rate and the number of FFT points. If the number of FFT points is a fixed value (65535 at most), then the lower the sample rate, the higher the resolution.



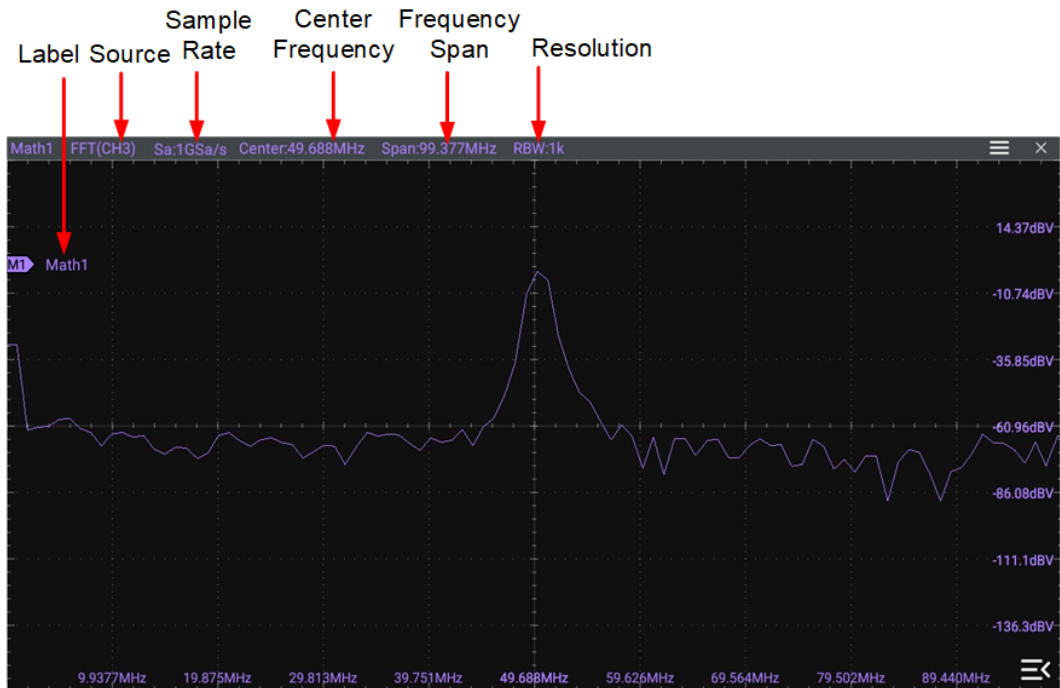

Figure 9.8 FFT Operation Window

### Source

Click or tap the **Source** drop-down button to select CH1, CH2, CH3, or CH4 as the source. When a source channel is selected, the selected channel automatically switches to the ON state.

### Auto Set

Click or tap **AutoSetting** to adjust the vertical scale and the offset of the operation results to the optimal value according to the current configuration for you to better observe.

### Frequency Range

In the **X** item, select "Span-Center" (frequency span to center frequency) or "Start-End" (start frequency to stop frequency) to define the frequency range.

- **Span-Center (frequency span to center frequency):** Span specifies the frequency range represented by the width of the display. Divide the frequency span by 10 to obtain the frequency per division.

Click or tap the **Center** input field to set the frequency of the frequency-domain waveform relative to the horizontal center of the screen. You can also use the corresponding multipurpose knob to set the value. Its range is from 5 Hz to 1 GHz. Click or tap the **Span** input field to set the frequency span with the pop-up numeric keypad. You can also use the corresponding multipurpose knob to set the value. Its range is from 10 Hz to 1 GHz.

- **Start-End (start frequency to stop frequency):** Start frequency specifies the frequency at the left side of the display. Click or tap the **Start** input field to set the start frequency with the pop-up numeric keypad or use the corresponding multipurpose knob to set the value. Its range is from 0 Hz to (stop frequency-10 Hz). Stop frequency specifies the frequency at the right side of the display. Click or tap the **End** input field to set the stop frequency with the pop-up numeric keypad or use the corresponding multipurpose knob to set the value. Its range is from (start frequency+10 Hz) to 1 GHz. By default, it is 10 MHz.

### Vertical Scale/Offset

In **Unit** item, you can select **dBm/dBV** or **Vrms** as the unit for **Scale** and **Offset**.

For how to set the **Scale**, refer to the descriptions in *Scale* "Arithmetic Operation". For how to set the **Offset**, refer to the descriptions in *Offset* in "Arithmetic Operation".

### Window Function

Spectral leakage can be considerably minimized when a window function is used. The oscilloscope provides 6 FFT window functions which have different characteristics and are applicable to measure different waveforms, as shown in the table below. You need to select the window function according to the characteristics of the waveform to be measured. Click or tap the **Window** drop-down button to select the desired window function.

**Table 9.1 Window Function**

Window Function	Characteristics	Waveforms Applicable to the Window Function
Rectangular	Best frequency resolution Poorest amplitude resolution Similar to the situation when no window is applied.	Transient or short pulse, the signal levels before and after the multiplication are basically the same Sine waveforms with the same amplitudes and rather similar frequencies Wide band random noise with relatively slow change of waveform spectrum
Blackman-Harris	Best amplitude resolution Poorest frequency resolution	Single frequency signal, searching for higher order harmonics

Window Function	Characteristics	Waveforms Applicable to the Window Function
Hanning	Better frequency resolution and poorer amplitude resolution compared with Rectangular	Sine, periodic, and narrow band random noise
Hamming	A little bit better frequency resolution than Hanning	Transient or short pulse, the signal levels before and after the multiplication are rather different
Flattop	Measure the signals accurately	The signal that has no accurate reference and requires an accurate measurement
Triangle	Better frequency resolution	Narrow band signal and that has strong noise interference

### Color Grade

Click or tap the **Color Grade** on/off switch to enable/disable the color grade display of FFT operation results. When enabled, different colors are displayed on the screen to indicate the times of data acquisition or acquisition probability. Click or tap the **Reset** button for the Color Grade menu to clear the color grade display and display the color grade again.

### Peak Search

Click or tap the icon  at the right side of **Peak Search** to enter the peak search menu, as shown in the figure below.

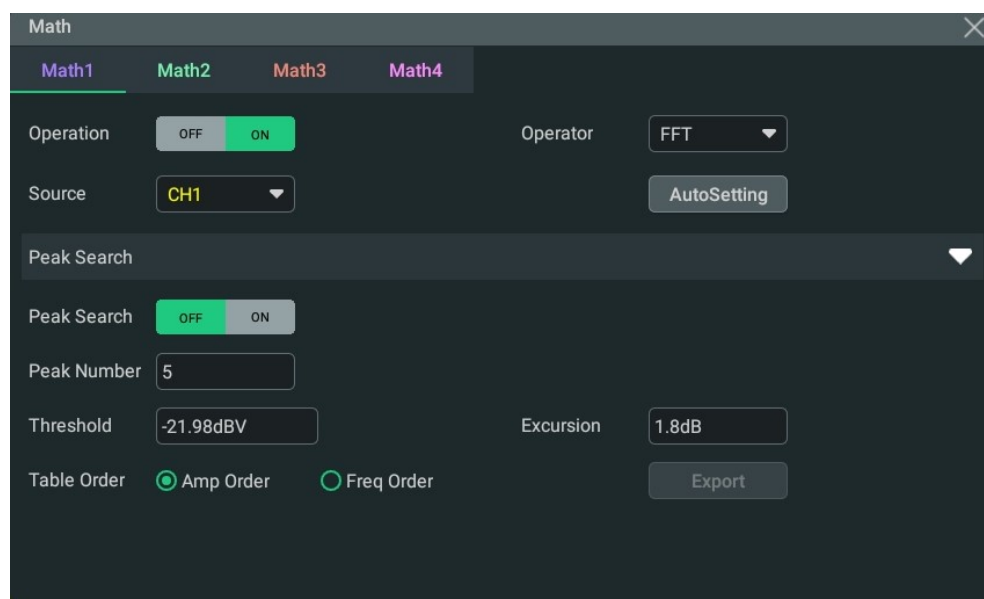



Figure 9.9 Peak Search

- **Peak Search ON/OFF:** click or tap the **Peak Search** on/off switch to enable or disable the display of the peak search window. By default, it is OFF.
- **Peak Number:** click or tap the **Peak Number** input field and use the pop-up numeric keypad to set the number of peaks or use the corresponding multipurpose knob to set the value. Its range is from 1 to 15. Its default value is 5.
- **Threshold:** click or tap the **Threshold** input field to set the threshold of the peak with the pop-up numeric keypad. The range of the threshold is related to the current FFT scale and offset.
- **Excursion:** click or tap the **Excursion** input field to set the excursion of the peak or use the corresponding multipurpose knob to set the value. The minimum value of Excursion is 0 and its unit is dB.
- **Table Order:** in **Table Order**, select **Amp Order** or **Freq Order** as the sorting mode. By default, it is "Amp Order".

Click or tap **Export**, then the save setting interface is displayed. You can export the peak search results to the internal memory or the external USB storage device in CSV format. In the menu, click or tap **File Name** input field to set the file name; click or tap **File Path** input field and the disk management menu (*Disk Management*) is displayed. Select the desired location to save the file and then click or tap **Save** to save the peak search results.

Clicking or tapping the icon  at the right side of **Peak Search** can close the peak search menu.

## 9.4 Logic Operation

In the **Math** menu, click or tap the **Operator** drop-down button to select the desired math operation. The logic operations supported by this oscilloscope include  $A \& B$ ,  $A || B$ ,  $A \wedge B$ , and  $\neg A$ . After selecting the desired logic operation in the drop-down button of **Operator**, you can configure its settings for the selected logic operation type.

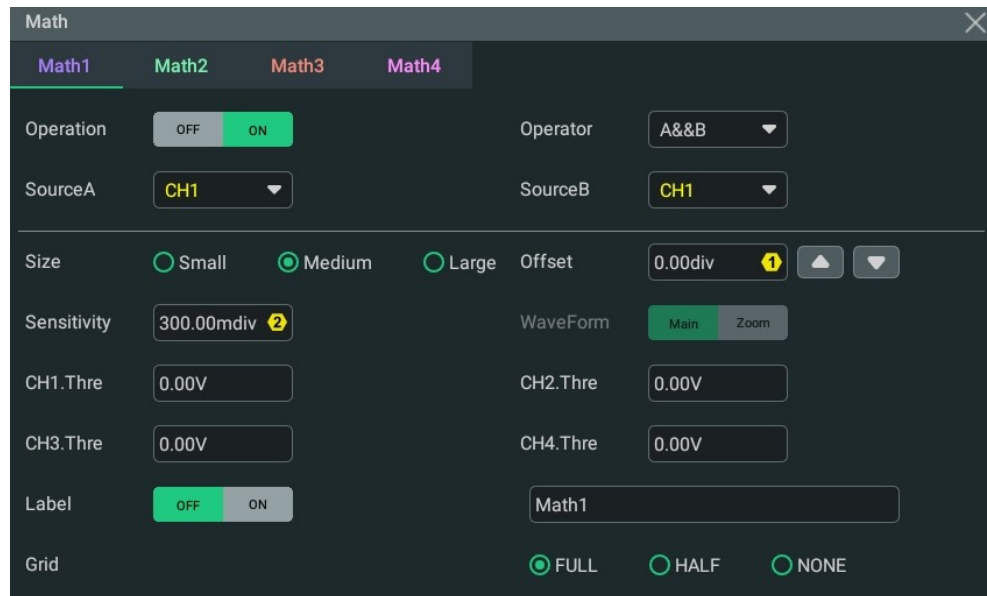

**Figure 9.10 Logic Operation Menu**

- **A&&B:** Performs logic "AND" operation on the waveform voltage values of the specified sources point by point and displays the results. In operation, when the voltage value of the source channel is greater than the threshold of the corresponding channel, it is regarded as logic "1"; otherwise it is logic "0". The results of logic AND operation of two binary bits are shown in [Table 9.2 Logic Operation](#).
- **A||B:** Performs logic "OR" operation on the waveform voltage values of the specified sources point by point and displays the results. In operation, when the voltage value of the source channel is greater than the threshold of the corresponding channel, it is regarded as logic "1"; otherwise it is logic "0". The results of logic OR operation of two binary bits are shown in [Table 9.2 Logic Operation](#).
- **A^B:** Performs logic "XOR" operation on the waveform voltage values of the specified sources point by point and displays the results. In operation, when the voltage value of the source channel is greater than the threshold of the corresponding channel, it is regarded as logic "1"; otherwise it is logic "0". The results of logic XOR operation of two binary bits are shown in [Table 9.2 Logic Operation](#).
- **!A:** Performs logic "NOT" operation on the waveform voltage values of the specified sources point by point and displays the results. In operation, when the voltage value of the source channel is greater than the threshold of the corresponding channel, it is regarded as logic "1"; otherwise it is logic "0". The results of logic "NOT" operation of one binary bit are shown in [Table 9.2 Logic Operation](#).

Table 9.2 Logic Operation

A	B	A&&B	A  B	A^B	!A
0	0	0	0	0	1
0	1	0	1	1	1
1	0	0	1	1	0
1	1	1	1	0	0

### Operation Result Display Window

Click or tap the **Operation** on/off switch to enable or disable the display of the operation result window. The source and the waveform sizes parameters are displayed at the top of the window, as shown in the figure below.

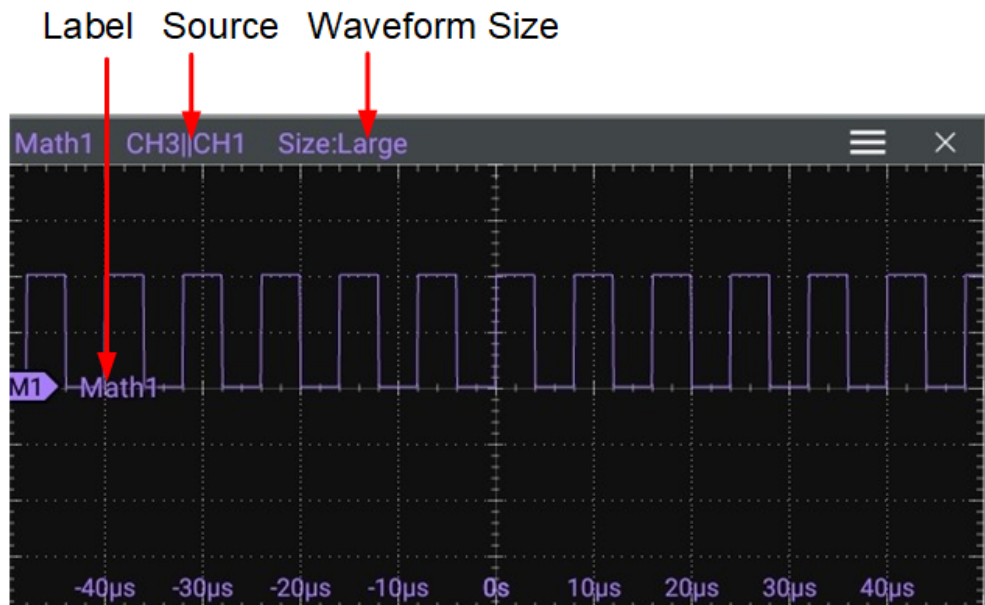

Figure 9.11 Operation Result Display Window

### Source

Click or tap the drop-down button of **SourceA** or **SourceB** to select CH1, CH2, CH3, or CH4. When a source channel is selected, the selected channel automatically switches to the ON state.

### Wave Size

You can select "Small", "Medium", or "Large" as the the waveform display mode.



## Offset

Offset is used to set the vertical offset of the operation result. You can set the vertical offset in the following ways.

- In **Vertical** menu, rotate the corresponding multipurpose knob on the front panel or click or tap the icon at the right side of the input field of **Offset** to increase or decrease the scale value. You can also click or tap the input field to input a specific value with the displayed numeric keypad.
- Close the menu and then adjust the vertical offset with the drag gesture on the touch screen. You can also rotate the corresponding multipurpose knob on the front panel to adjust the vertical offset. Please refer to *Front Panel Overview* to configure the front-panel multipurpose knobs.

## Sensitivity

Sets the sensitivity of the digital signal converted from the analog signal on the source. Click or tap the **Sensitivity** input field to set the sensitivity with the pop-up numeric keypad or use the corresponding multipurpose knob to set the value. For details, refer to *Parameter Setting Method*.

## Waveform

This oscilloscope supports Main (default) and Zoom.

- **Main** indicates that the measurement range is within the main time base region.
- **Zoom** indicates that the measurement range is within the zoomed time base region.

To use "Zoom", first enable the *Zoom Mode (Delayed Sweep)* in the Horizontal menu (*Horizontal System*).

## Threshold

Click or tap the threshold input field of the specified channel and use the pop-up numeric keypad to set the threshold or use the corresponding multipurpose knob to set the value.

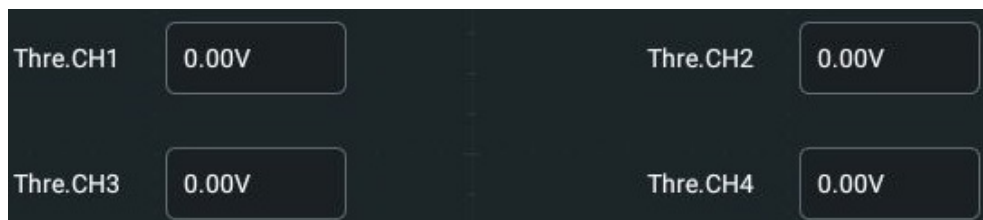

## Label

It is used to set the label for the math operation results. For setting methods, refer to descriptions in *To Turn the Channel Label Display On/Off*.

## Grid

For setting methods, refer to the descriptions in *To Set the Screen Grid*.

## 9.5 Digital Filter

In the **Math** menu, click or the **Operator** drop-down button to select the desired math operation. The digital filters supported by this oscilloscope include: low-pass filter, high-pass filter, band-pass filter, and band-stop filter.

- **LowPass** only allows the signals whose frequencies are lower than the current upper limit frequency to pass.
- **HighPass** only allows the signals whose frequencies are higher than the current lower limit frequency to pass.
- **BandPass** only allows the signals whose frequencies are higher than the current lower limit frequency and lower than the current upper limit frequency to pass.
- **BandStop** only allows the signals whose frequencies are lower than the current lower limit frequency or higher than the current upper limit frequency to pass.

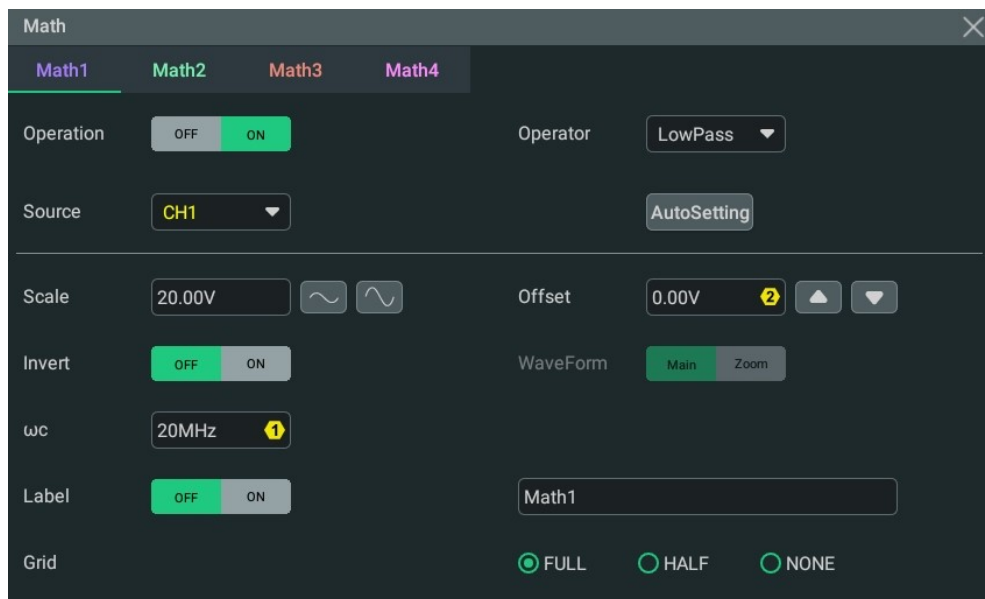

Figure 9.12 Digital Filter Menu

### Operation Result Display Window

Click or tap the **Operation** on/off switch to enable or disable the display of the operation result window. The source and the vertical scale parameters are displayed at the top of the window, as shown in the figure below.



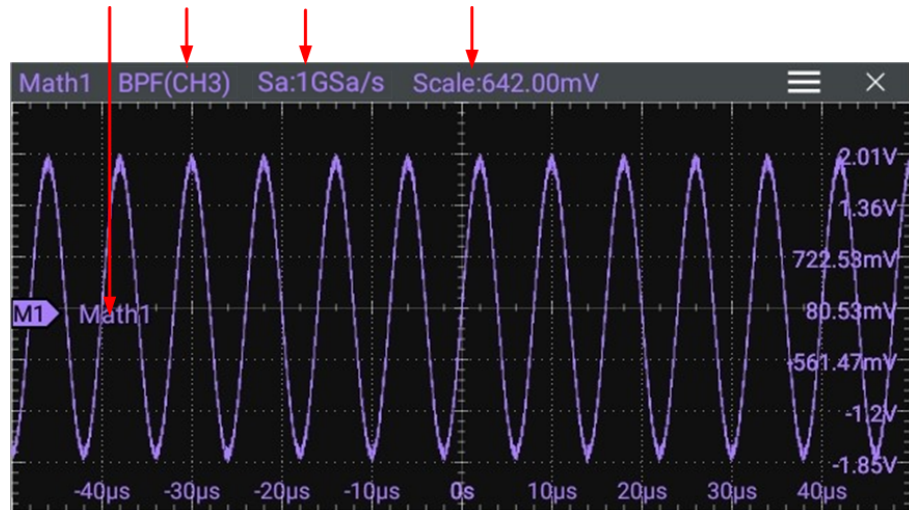

Figure 9.13 Operation Result Display Window

### Source

Click or tap the drop-down button for the **Source** to select CH1, CH2, CH3, or CH4 as the source. When a source channel is selected, the selected channel automatically switches to the ON state.

### Auto Set

Click or tap **AutoSetting** to adjust the vertical scale and the offset of the operation results to the optimal value according to the current configuration for you to better observe.

### Scale

Scale is used to set the vertical scale of the operation result. You can set the vertical scale in the following ways.

- In **Vertical** menu, rotate the corresponding multipurpose knob on the front panel or click or tap the icon at the right side of the input field of **Scale** to increase or decrease the scale value. You can also click or tap the input field to input a specific value with the displayed numeric keypad.
- Close the menu and then adjust the vertical scale with the pinch & stretch gesture on the touch screen. You can also rotate the corresponding multipurpose knob on the front panel to adjust the vertical scale. Please refer to *Front Panel Overview* to configure the front-panel multipurpose knobs.

### Offset

Offset is used to set the vertical offset of the operation result. You can set the vertical offset in the following ways.

- In **Vertical** menu, rotate the corresponding multipurpose knob on the front panel or click or tap the icon at the right side of the input field of **Offset** to

increase or decrease the scale value. You can also click or tap the input field to input a specific value with the displayed numeric keypad.

- Close the menu and then adjust the vertical offset with the drag gesture on the touch screen. You can also rotate the corresponding multipurpose knob on the front panel to adjust the vertical offset. Please refer to *Front Panel Overview* to configure the front-panel multipurpose knobs.

### Invert

Invert is used to enable or disable the inverted display of the waveform. For setting methods, refer to descriptions in *To Invert a Waveform*.

### Waveform

This oscilloscope supports Main (default) and Zoom.

- **Main** indicates that the measurement range is within the main time base region.
- **Zoom** indicates that the measurement range is within the zoomed time base region.

To use "Zoom", first enable the *Zoom Mode (Delayed Sweep)* in the Horizontal menu (*Horizontal System*).

### Frequency Limit

- **LowPass:** click or tap the **ωc** input field and use the pop-up numeric keypad to set the upper limit frequency or use the corresponding multipurpose knob to set the value.
- **HighPass:** click or tap the **ωc** input field and use the pop-up numeric keypad to set the lower limit frequency or use the corresponding multipurpose knob to set the value.
- **BandPass:** click or tap the **ωc1** input field and use the pop-up numeric keypad to set the lower limit frequency. Click or tap the **ωc2** input field and use the pop-up numeric keypad to set the upper limit frequency. You can also use the corresponding multipurpose knob to set the value to set the lower/upper limit frequency.
- **BandStop:** click or tap the **ωc1** input field and use the pop-up numeric keypad to set the lower limit frequency. Click or tap the **ωc2** input field and use the pop-up numeric keypad to set the upper limit frequency. You can also use the corresponding multipurpose knob to set the value to set the lower/upper limit frequency.

The settable ranges of the upper and lower limit frequencies are related to the Math sample rate (displayed at the bottom of the screen when the Math function is enabled). The sample rate of the analog channel or the changes of the memory depth can affect the Math sample rate.

**Label**



It is used to set the label for the math operation results. For setting methods, refer to descriptions in *To Turn the Channel Label Display On/Off*.

**Grid**

For setting methods, refer to the descriptions in *To Set the Screen Grid*.

## 10 Measurements

You can enter the **Measure** menu in the following ways:

- Click or tap the function navigation icon  at the lower-left corner of the screen, and then select **Measure** to enter the "Measure" menu.
- Press the front-panel  key to enter the "Measure" menu.
- Click or tap the **Measure** button in the toolbar to enter the "Measure" menu.
- In *Vertical System* menu, click or tap the **Measure** button to enter the "Measure" menu.

### 10.1 Measurement Parameter

This oscilloscope allows you to set the measurement source, enable or disable the all measurement function, the statistical function, and etc. You can make quick measurements for many waveform parameters. The measurement results will be displayed in the **Result** sidebar at the right section of the screen.



#### TIP

If there is no signal input for the current source or the measurement result is not within the valid range (too large or too small), then the measurement results are invalid, and "\*\*\*\*\*" is displayed on the screen. Please re-input the signal or set the signal.

## 10.1.1 Time Parameters

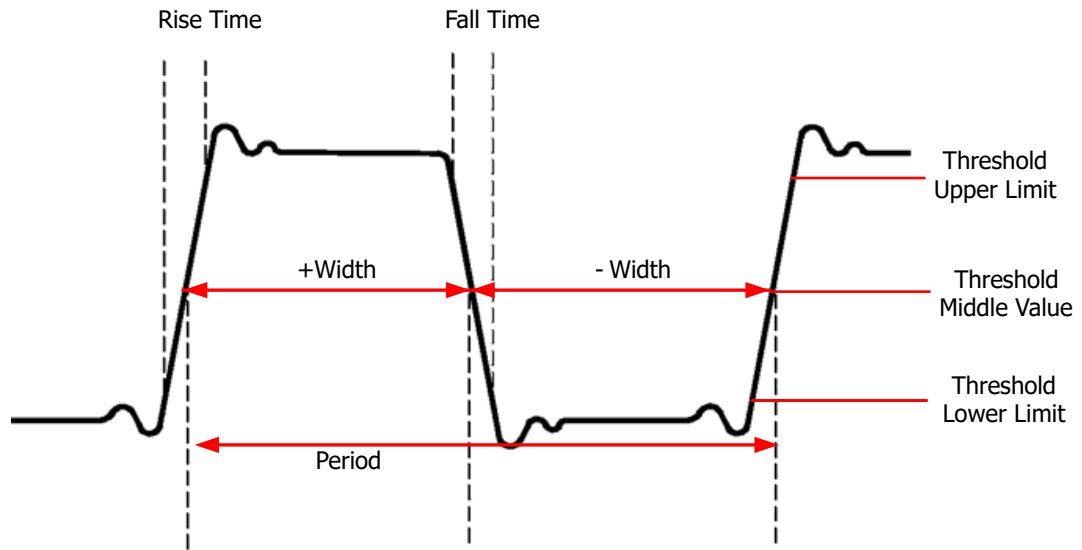

**Figure 10.1 Time Parameters**

- **Period:** defined as the time between the middle threshold points of two consecutive, like-polarity edges.
- **Frequency:** defined as the reciprocal of period.
- **Rise Time:** indicates the time for the signal amplitude to rise from the threshold lower limit to the threshold upper limit.
- **Fall Time:** indicates the time for the signal amplitude to rise from the threshold upper limit to the threshold lower limit.
- **+Width:** indicates the time between the threshold middle value of a rising edge to the threshold middle value of the next falling edge.
- **-Width:** indicates the time between the threshold middle value of a falling edge to the threshold middle value of the next rising edge.
- **+Duty:** indicates the ratio of the positive pulse width to the period.
- **-Duty:** indicates the ratio of the negative pulse width to the period.
- **Tvmax:** indicates the time that corresponds to the maximum value of the waveform ( $V_{max}$ ).
- **Tvmin:** indicates the time that corresponds to the minimum value of the waveform ( $V_{min}$ ).

The default values for threshold upper limit, threshold middle value, and threshold low limit are 90%, 50%, and 10%, respectively.

## 10.1.2 Count Values

The default values for threshold upper limit and threshold low limit are 90% and 10%, respectively.

### Positive Pulse Count

It is specified as the number of positive pulses that rise from under the threshold lower limit to above the threshold upper limit.

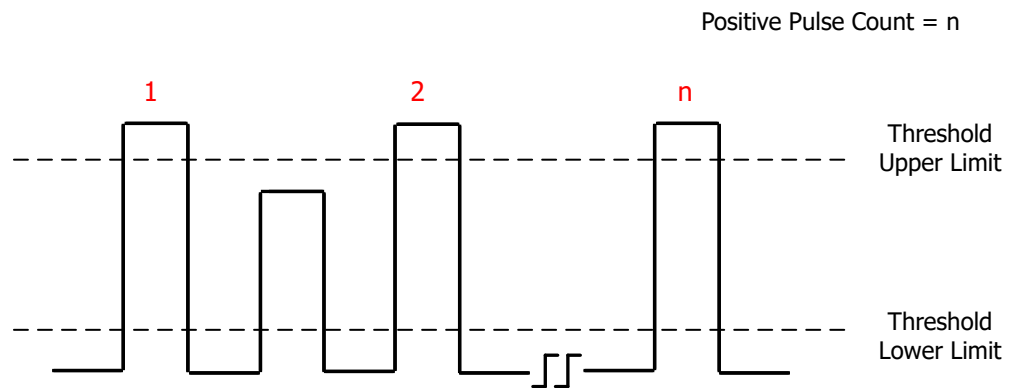

### Negative Pulse Count

It is specified as the number of negative pulses that fall from above the threshold upper limit to below the threshold lower limit.

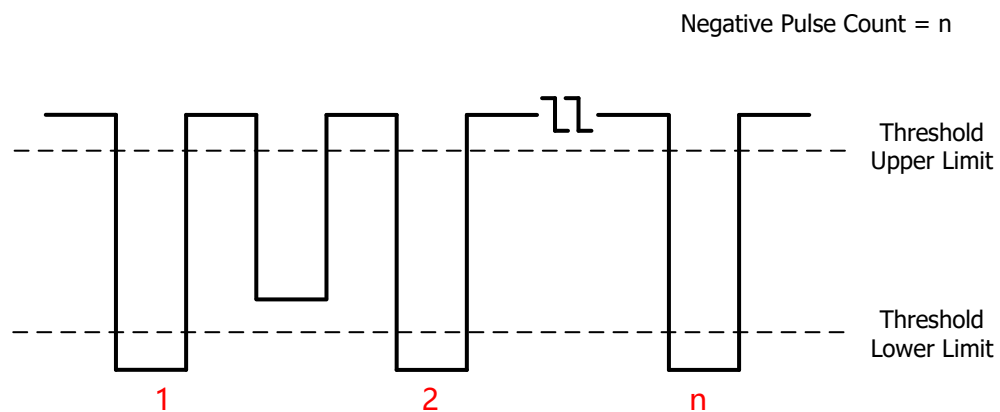

### Rising Edge Count

It is specified as the number of rising edges that rise from under the threshold lower limit to above the threshold upper limit.

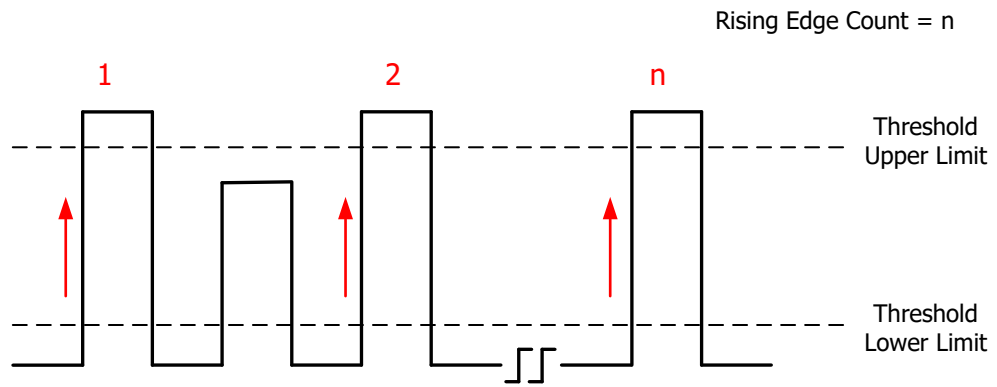

### Falling Edge Count

It is specified as the number of falling edges that fall from above the threshold upper limit to below the threshold lower limit.

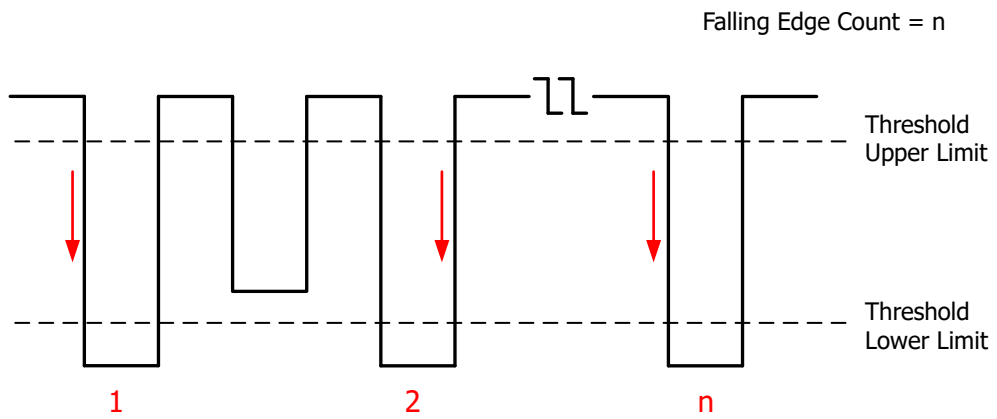

### 10.1.3 Delay and Phase Parameters

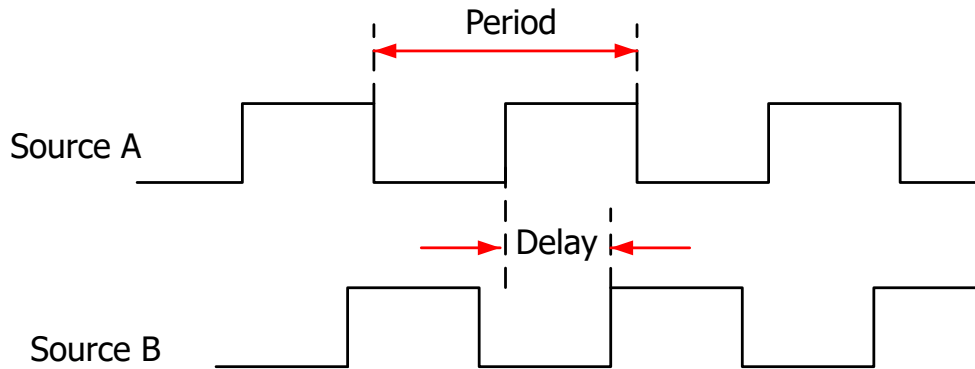

**Figure 10.2 Delay and Phase Parameters**

1. **Delay(r-r)**: indicates the time difference between the threshold middle values of the rising edge of Source A and that of Source B. Negative delay indicates that the rising edge of Source A occurred after that of Source B.
2. **Delay(f-f)**: indicates the time difference between the threshold middle values of the falling edge of Source A and that of Source B. Negative delay indicates that the falling edge of Source A occurred after that of Source B.
3. **Delay(r-f)**: indicates the time difference between the threshold middle values of the rising edge of Source A and the falling edge of Source B. Negative delay indicates that the rising edge of Source A occurred after the falling edge of Source B.
4. **Delay(f-r)**: indicates the time difference between the threshold middle values of the falling edge of Source A and the rising edge of Source B. Negative delay indicates that the falling edge of Source A occurred after the rising edge of Source B.
5. **Phase(r-r)**: indicates the phase deviation between the threshold middle values of the rising edge of Source A and that of Source B. The phase formula is as follows:

$$PhaseA_{RB_R} = \frac{DelayA_{RB_R}}{Period_{sourceA}} \times 360^\circ$$

Wherein,  $PhaseA_{RB_R}$  represents Phase(r-r),  $DelayA_{RB_R}$  represents Delay(r-r), and  $Period_{sourceA}$  represents period of Source A.

6. **Phase(f-f)**: indicates the phase deviation between the threshold middle values of the falling edge of Source A and that of Source B. The phase formula is as follows:

$$PhaseA_{FB_F} = \frac{DelayA_{FB_F}}{Period_{sourceA}} \times 360^\circ$$



Wherein,  $PhaseA_R B_R$  represents Phase(r-r),  $DelayA_R B_R$  represents Delay(r-r), and  $Period_{sourceA}$  represents period of Source A.

- 7. Phase(r-f):** indicates the phase deviation between the threshold middle values of the rising edge of Source A and the falling edge of Source B. The phase formula is as follows:

$$PhaseA_R B_F = \frac{DelayA_R B_F}{Period_{sourceA}} \times 360^\circ$$

Wherein,  $PhaseA_R B_R$  represents Phase(r-r),  $DelayA_R B_R$  represents Delay(r-r), and  $Period_{sourceA}$  represents period of Source A.

- 8. Phase(f-f):** indicates the phase deviation between the threshold middle values of the falling edge of Source A and the rising edge of Source B. The phase formula is as follows:

$$PhaseA_F B_R = \frac{DelayA_F B_R}{Period_{sourceA}} \times 360^\circ$$

Wherein,  $PhaseA_R B_R$  represents Phase(r-r),  $DelayA_R B_R$  represents Delay(r-r), and  $Period_{sourceA}$  represents period of Source A.



**TIP**

- Source A and Source B can be any channel among CH1~CH4 and Math1~Math4.
- The default threshold middle value is 50%.

## 10.1.4 Voltage Parameters

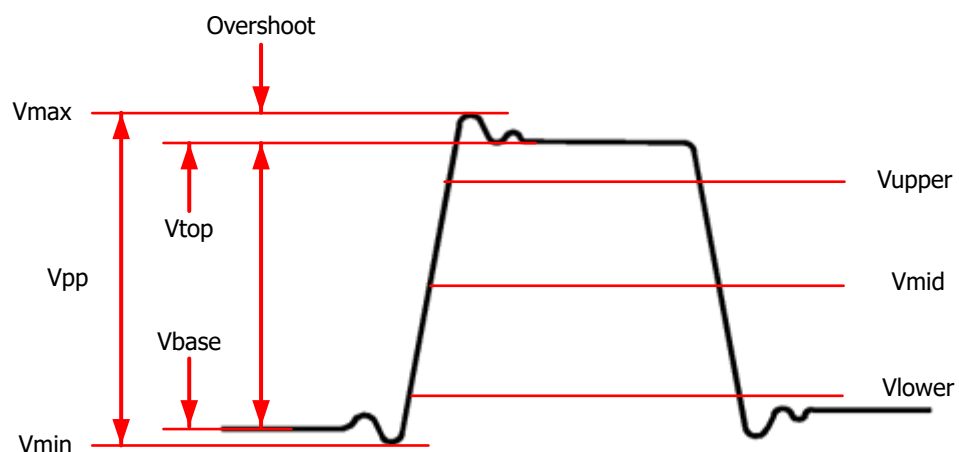

**Figure 10.3 Voltage Parameters**

- 1. Vmax:** indicates the voltage value from the highest point of the waveform to the GND.

2. **Vmin:** indicates the voltage value from the lowest point of the waveform to the GND.
3. **Vpp:** the voltage value from the highest point to the lowest point of the waveform.
4. **Vtop:** indicates the voltage value from the flat top of the waveform to the GND.
5. **Vbase:** indicates the voltage value from the flat base of the waveform to the GND.
6. **Vamp:** indicates the voltage value from the top of the waveform to the base of the waveform.
7. **Vupper:** indicates the actual voltage value that corresponds to the threshold maximum value.
8. **Vmid:** indicates the actual voltage value that corresponds to the threshold middle value.
9. **Vlower:** indicates the actual voltage value that corresponds to the threshold minimum value.
10. **Vavg:** indicates the arithmetic average value on the whole waveform or in the gating area. The formula is shown as follows:

$$Average = \frac{\sum_{i=1}^n x_i}{n}$$

Wherein,  $x_i$  is the  $i$ th point, and  $n$  is the number of points being measured.

11. **VRMS:** indicates the root mean square value on the whole waveform or in the gating area. The formula is as follows:

$$RMS = \sqrt{\frac{\sum_{i=1}^n x_i^2}{n}}$$

Wherein,  $x_i$  is the measurement result of the  $i$ th point, and  $n$  is the number of points being measured.

12. **Per.VRMS:** indicates the root mean square value within a period. The formula is as shown above.
13. **Overshoot:** indicates the ratio of the difference between the maximum value and the top value of the waveform to the amplitude value.
14. **Preshoot:** indicates the ratio of the difference between the minimum value and the base value of the waveform to the amplitude value.
15. **AC RMS:** indicates the root-mean-square value of the waveforms, with the DC component removed. The formula is shown as follows:

$$\text{Std.Dev} = \sqrt{\frac{\sum_{i=1}^n (x_i - \text{Average})^2}{n}}$$

Wherein,  $x_i$  is the amplitude of the  $i$ th point, *Average* is the waveform average value, and  $n$  is the number of points being measured.

### 10.1.5 Other Parameters

- **Positive Slew Rate:** On the rising edge, first calculate the difference between the high value and the low value, then use the difference to divide the corresponding time value to obtain the positive slew rate.
- **Negative Slew Rate:** On the falling edge, first calculate the difference between the low value and the high value, then use the difference to divide the corresponding time value to obtain the negative slew rate.
- **Area:** indicates the area of the whole waveform within the screen. The unit is V\*s. The area of the waveform above the zero reference (namely the vertical offset) is positive, and the area of the waveform below the zero reference is negative. The area measured is the algebraic sum of the area of the whole waveform within the screen.
- **Period Area:** indicates the area of the first period of waveform on the screen. The unit is V\*s. The area of the waveform above the zero reference (namely the vertical offset) is positive, and the area of the waveform below the zero reference is negative. The area measured is the algebraic sum of the whole period area.

## 10.2 Select the Measurement Item

In the **Measure** menu, click or tap **Horizontal**, **Vertical**, or **Other** to go to the desired menu. You can also slide to select the measurement item to enter the corresponding interface, as shown in *Figure 10.4*, *Figure 10.5*, and *Figure 10.6*. Click or tap any of the measurement items to enable the measurements. This series allows you to enable measurements of up to 14 items at the same time.

#### TIP

You can also refer to *Multi-pane Windowing* to enable all measurements.



- **Vertical:** Vmax, Vmin, Vpp, Vtop, Vbase, Vamp, Vupper, Vmid, Vlower, Vavg, VRMS, Per. VRMS, Overshoot, Preshoot, Area, Per.Area, and AC.RMS.

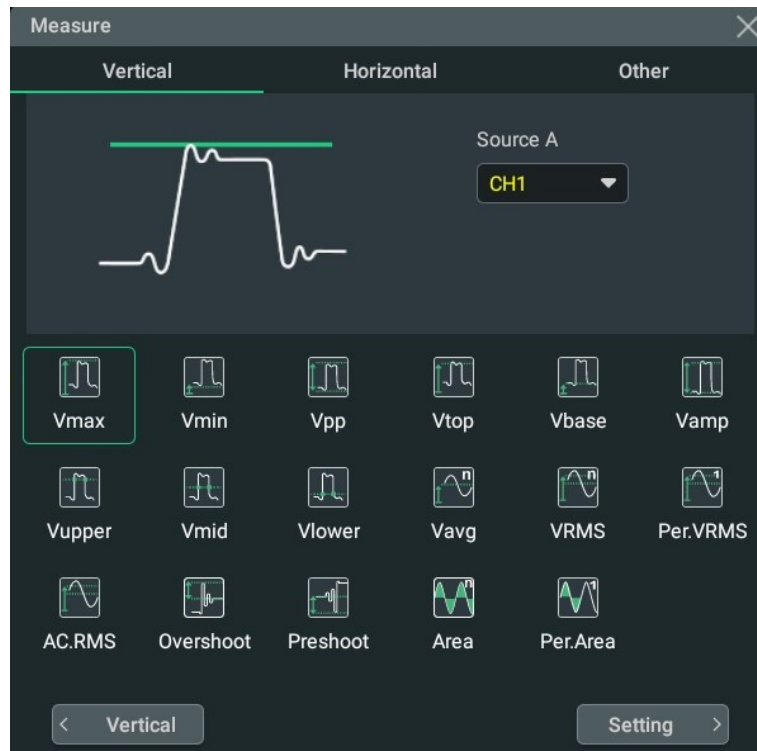

**Figure 10.4 Vertical Measurement Items**

- **Horizontal:** Period, Frequency, Rise Time, Fall Time, +Width, -Width, +Duty, -Duty, Positive Pulse Count, Negative Pulse Count, Rising Edge Count, Falling Edge Count, T<sub>vmax</sub>, T<sub>vmin</sub>, +Slew Rate, and -Slew Rate.

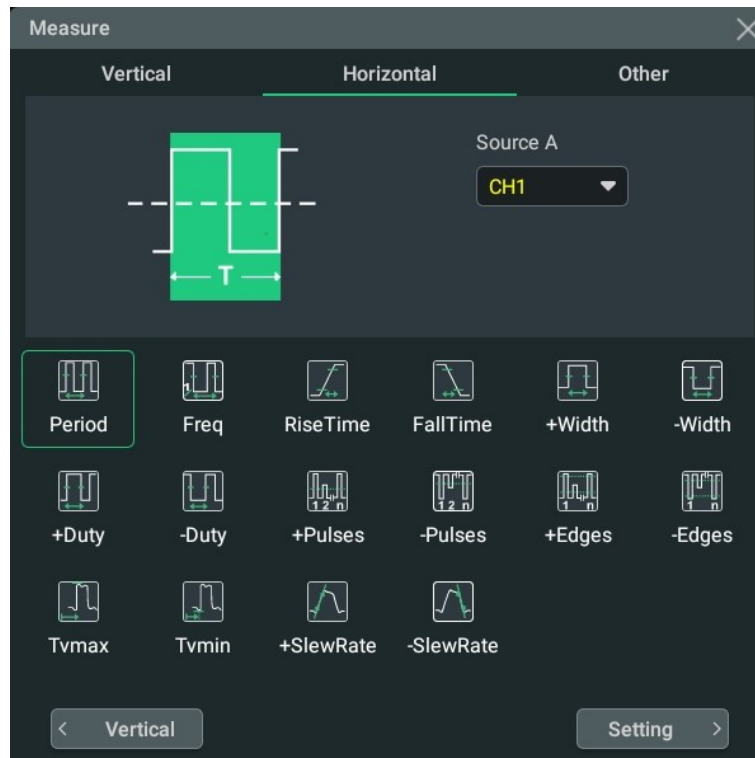

**Figure 10.5 Horizontal Measurement Items**

- **Other:** Delay (r-r), Delay (r-f), Delay (f-r), Delay (f-f), Phase (r-r), Phase (r-f), Phase(f-r), and Phase (f-f).

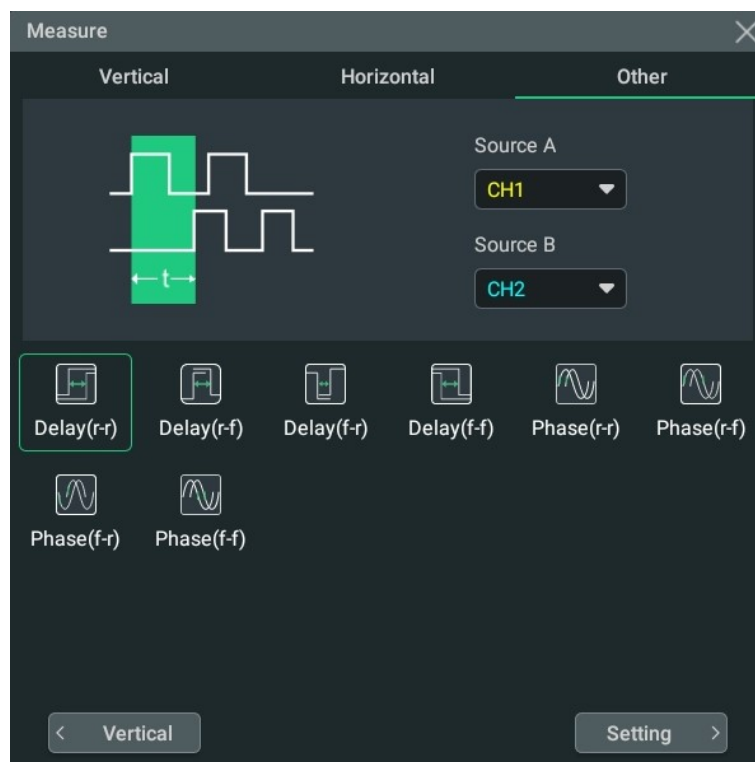

**Figure 10.6 Other Measurement Items**

## 10.3 Measurement Settings

In the **Measure** menu, click or tap the **Setting** button to enter the measurement setting menu.

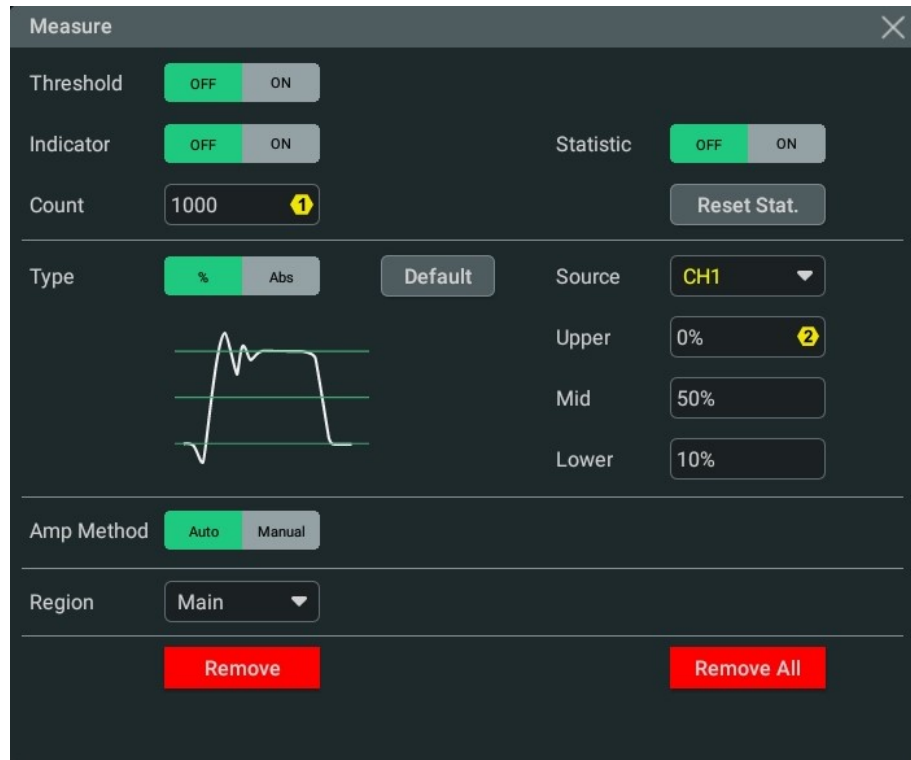

Figure 10.7 Measurement Settings

### Indicator

In the **Measure** setting menu, click or tap the **Indicator** on/off switch to enable or disable the indicator.

If enabled, one or more cursors will be displayed on the screen. Before enabling the indicator, you need to enable at least one auto measurement parameter and the number of cursors will change with the measurement parameter enabled.

### TIP

When no measurement parameter is selected or there is no source input, the indicator is not available. The indicator changes when the waveform is expanded or compressed horizontally.

### Measurement Threshold

- First, select **%** or **Abs** as the display type.
- Click or tap the drop-down button of **Source** to select the desired channel from CH1 to CH4 or from Math1 to Math4.

- Click or tap the input field of **Upper** and use the pop-up numeric keypad to set the upper limit of the measurement or use the corresponding multipurpose knob to set the value. When the upper limit is set to be smaller than or equal to the current middle value, a prompt message "Set at lower limit" is displayed. Then, the oscilloscope will automatically adjust the upper limit and make it greater than the middle value. By default, it is 90%. The default absolute value varies with the vertical setting of the channel.
- Click or tap the input field of **Mid** and use the pop-up numeric keypad to set the middle value of the measurement or use the corresponding multipurpose knob to set the value. The middle value is limited by the settings of the upper limit and lower limit. By default, it is 50%. The default absolute value varies with the vertical setting of the channel.
- Click or tap the input field of **Lower** and use the pop-up numeric keypad to set the lower limit of the measurement or use the corresponding multipurpose knob to set the value. When the lower limit is set to be greater than or equal to the current middle value, a prompt message "Set at upper limit" is displayed. Then, the oscilloscope will automatically adjust the lower limit and make it smaller than the middle value. By default, it is 10%. The default absolute value varies with the vertical setting of the channel.
- Click **Default** to return the upper, middle, and lower limits to their default values.

Click or tap the **Threshold** on/off switch to enable or disable the threshold settings.

#### TIP

Modifying the threshold will affect the measurement results of time, delay, and phase parameters.

#### Measurement Range

Click or tap the drop-down button of the **Region** to select "Main" or "Zoom".

- **Main:** indicates that the measurement range is within the main time base region.
- **Zoom:** indicates that the measurement range is within the zoomed time base region.

#### TIP

To use "Zoom", you need to enable *Zoom Mode (Delayed Sweep)* first.

#### Amplitude Measurement Method

Click or tap **Auto** or **Manual** as the amplitude measurement method, which affects the measurement method for the top and base values.

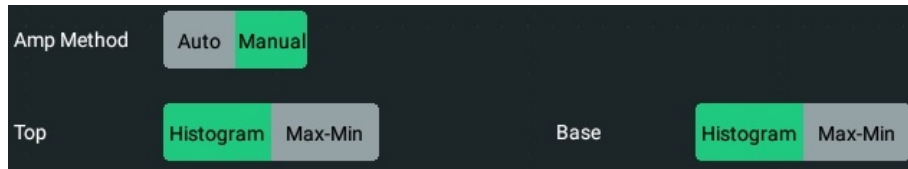

If you select "Manual", set the following parameters:

- Click or tap the **Top** toggle button to select **Histogram** or **Max-Min** as the top value measurement method.
- Click or tap the **Base** toggle button to select **Histogram** or **Max-Min** as the base value measurement method.



#### TIP

If you select "Manual" for the amplitude method, the measurement results of other parameters may be affected.

"Histogram" and "Max-Min" are the internal measurement algorithm for the oscilloscope.

#### Remove the Measurement Results

Refer to [Remove the Measurement Results](#).



#### Statistics

Click or tap the **Statistic** on/off switch to enable or disable the statistical function. This oscilloscope can make a statistics and display the current values of the multiple parameters, as shown in the figure below.



- Click or tap any measurement item in the "Result" sidebar at the right side of the screen and a window is displayed. Click or tap **Reset Stat.** to clear the history statistics data and makes statistics again. You can also click or tap **Reset Stat.** in the measurement setting menu.
- Click or tap the input field of **Count** and use the pop-up numeric keypad to set the count value. You can also use the corresponding multipurpose knob to set the value. Its range is from 2 to 100000. Its default value is 1000.



- Click or tap the icon  at the lower-right corner of the measurement statistics label to unfold the statistics result to display all the measurement statistics items.
- Click or tap the icon  to fold the measurement statistics label.

## 10.4 Remove the Measurement Results

This oscilloscope allows you to delete the measurement results of the parameters.

- In **Measure** setting menu, click or tap **Remove** to delete the currently selected measurement item that you've added; click or tap **Remove All** to delete all the displayed measurement items.
- Click or tap any measurement item in the "Result" sidebar at the right side of the screen and a window is displayed. Click or tap **Remove** to delete the currently selected measurement item that you've added; click or tap **Remove All** to delete all the displayed measurement items.
- In the "Result" sidebar, select a measurement item and drag it to the right to delete it quickly.

## 10.5 Auto Measurement

When the oscilloscope is correctly connected and has detected a valid input signal, you can click or tap the function navigation icon  at the lower-left corner of the screen and select **Auto** to enable the waveform auto setting function and open the auto setting function menu.

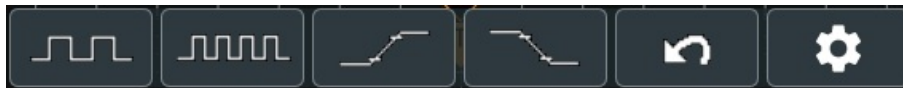

- Click or tap the first icon, and then the single period of the signal is displayed automatically on the screen. Meanwhile, the system will make measurements for the "period" and "frequency" of the currently displayed waveforms in a single period. The measurement results are displayed in the "Result" bar at the right side of the screen.
- Click or tap the second icon, and then multiple periods of the signal are displayed automatically on the screen. Meanwhile, the system will make measurements for the "period" and "frequency" of the currently displayed waveforms in a multiple periods. The measurement results are displayed in the "Result" bar at the right side of the screen.
- Click or tap the third icon, and then one rising edge of the signal is displayed automatically on the screen. Meanwhile, the system will make measurements for the "rise time" of the currently displayed rising edge. The measurement results

are displayed in the "Result" bar at the right side of the screen. By default, it is intended for the fast edge signal.

- Click or tap the fourth icon, and then one falling edge of the signal is displayed automatically on the screen. Meanwhile, the system will make measurements for the "Fall time" of the currently displayed falling edge. The measurement results are displayed in the "Result" bar at the right side of the screen. By default, it is intended for the fast edge signal.
- Click or tap the fifth icon to cancel the auto setting and recovers to the parameter settings prior to clicking or tapping **Auto**.
- Click or tap the sixth icon to enter the **Auto Config** sub-menu under the **Utility** menu. For details, please refer to *Auto Config*.



#### TIP

The waveform auto setting function requires that the frequency of the signal should be greater than or equal to 35 Hz, the amplitude greater than or equal to 5 mV. If not meeting the conditions, the waveform auto setting function may be invalid.

## 10.6 Cursor Measurements

Cursor measurement can measure the X axis values (e.g. Time) and Y axis values (e.g. Voltage) of the selected waveform. Before making cursor measurements, connect the signal to the oscilloscope to acquire stable display. All the parameters supported by the "*Auto Measurement*" function can be measured with cursor measurement. The cursor measurement function provides the following two cursors.

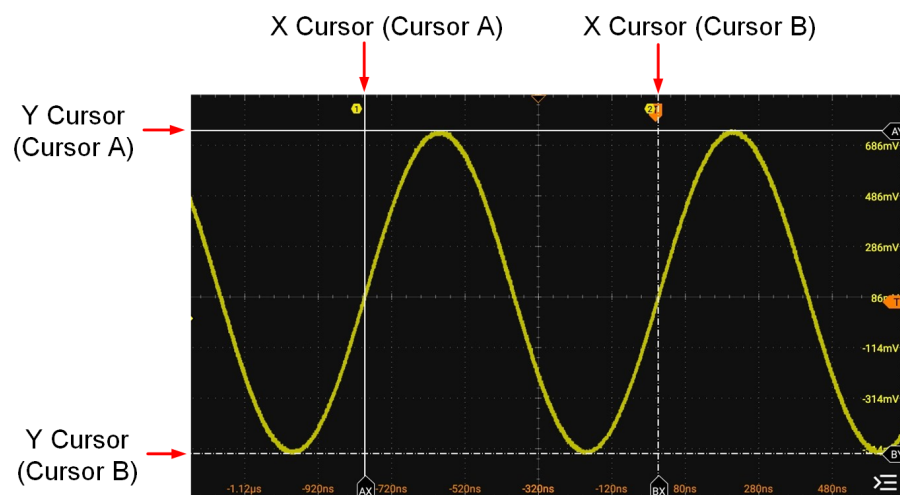







Figure 10.8 Cursor

- **X Cursor**

X cursor is a vertical solid/dotted line that is used to make horizontal adjustments. It can be used to measure time (s) and frequency (Hz).

- Cursor A is a vertical solid line ( is displayed at the bottom of the screen), and Cursor B is a vertical dotted line ( is displayed at the bottom of the screen).
- In the XY cursor mode, X cursor is used to measure the waveform amplitude of CH1.
- **Y Cursor**  
Y cursor is a horizontal solid/dotted line that is used to make vertical adjustments. It can be used to measure amplitude (the unit is the same as that of the source channel amplitude).
  - Cursor A is a horizontal solid line ( is displayed at the right section of the screen), and Cursor B is a horizontal dotted line ( is displayed at the right section of the screen).
  - In the XY cursor mode, Y cursor is used to measure the waveform amplitude of CH2.

You can enable cursor measurements in the following ways.

- Click or tap the function navigation icon  > **Cursors** to enable cursor measurements.
- Click or tap the **Cursors** button in the toolbar to enable cursor measurements.
- Press the front-panel  key to enable cursor measurements.

The measurement results will be displayed in the "Result" bar at the right section of the screen, as shown in the figure below.



```

Cursors(C1)
AX: 200ps
AY: 300mV
BX: 5ns
BY: -300mV
ΔX: 4.8ns
ΔY: -600mV
1/ΔX: 208.3MH
  
```

- AX: indicates the X value at Cursor A.
- AY: indicates the Y value at Cursor A.
- BX: indicates the X value at Cursor B.

- BY: indicates the Y value at Cursor B.
- $\Delta X$ : indicates the horizontal spacing between Cursor A and Cursor B.
- $\Delta Y$ : indicates the vertical spacing between Cursor A and Cursor B.
- $1/\Delta X$ : indicates the reciprocal of the horizontal spacing between Cursor A and Cursor B.

Click or tap the result bar and then select **Remove** or **Setting** in the pop-up window.

- If you select **Remove**, the current cursor measurement results will be cleared.
- Click or tap **Setting**. Then the "Cursors" menu is displayed. You can select the cursor mode: Manual, Track, and XY.

### 10.6.1 Manual Mode

In the manual cursor mode, you can adjust the cursor manually to measure the value of the waveforms of the specified source at the current cursor. If the settings for the parameter such as the cursor type and measurement source are different, the measurement results will be different for cursor measurement.

In the **Cursors** menu, click or tap **Manual** for the **Mode** item to enable the manual cursor measurement function. The measurement results are displayed in the "Result" bar at the right section of the screen. When you change the cursor position, the measurement results will be changed accordingly.

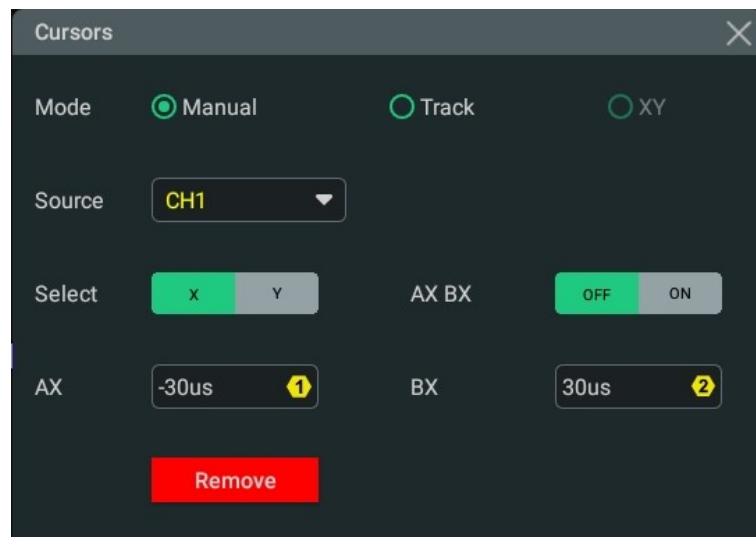

Figure 10.9 Manual Mode Setting Menu

#### Select Measurement Source

Click or tap the drop-down button of **Source** to select the desired channel (None, CH1~CH4, or Math1~Math4).

If the specified channel is selected as the source, the channel will be enabled automatically.

### Select Cursor Type

Click or tap the **Select** toggle button to select "X" or "Y".

- **X:** It is a pair of vertical solid (Cursor A)/dotted (Cursor B) lines, used for measuring time parameters. The measurement results include AX, BX,  $\Delta X$ , and  $1/\Delta X$ .
- **Y:** It is a pair of horizontal solid (Cursor A)/dotted (Cursor B) lines, used for measuring voltage parameters. The measurement results include AY, BY, and  $\Delta Y$ .

### Adjust Cursor Position

1. When "X" is selected, you can adjust the position of X cursor.

- Click or tap the input field of **AX** and use the pop-up numeric keypad to set the horizontal position of Cursor A (X cursors). The horizontal axis indicates time, and the unit of its setting value is the same as that of the horizontal unit. Its adjustable range is limited within the screen.
- Click or tap the input field of **BX** and then use the pop-up numeric keypad to set the horizontal position of Cursor B (X cursors). The horizontal axis indicates time, and the unit of its setting value is the same as that of the horizontal unit. Its adjustable range is limited within the screen.
- Click or tap the **AX BX** on/off switch to turn on/off adjusting the horizontal position of Cursor A and Cursor B (X cursors) simultaneously. The horizontal spacing between Cursor A and Cursor B (X cursors) remains unchanged.

2. When "Y" is selected, you can adjust the position of Y cursor.

- Click or tap the input field of **AY**, and then use the pop-up numeric keypad to set the vertical position of Cursor A (Y cursors). The vertical axis indicates voltage, and the unit of its setting value is the same as that of the vertical unit.
- Click or tap the input field of **BY**, and then use the pop-up numeric keypad to set the vertical position of Cursor B (Y cursor). The vertical axis indicates voltage, and the unit of its setting value is the same as that of the vertical unit.
- Click or tap the **AY BY** on/off switch to turn on/off adjusting the vertical position of Cursor A and Cursor B (Y cursors) simultaneously. The vertical spacing between Cursor A and Cursor B (Y cursors) remains unchanged.

You can also use the touch screen or the front-panel multipurpose knob  to adjust the cursor. To configure the multipurpose knobs, please refer to [Front Panel Overview](#).

## Measurement Example

Measure the period of a sine wave by using the manual cursor measurement and auto measurement respectively. The measurement results are both 800 ns.

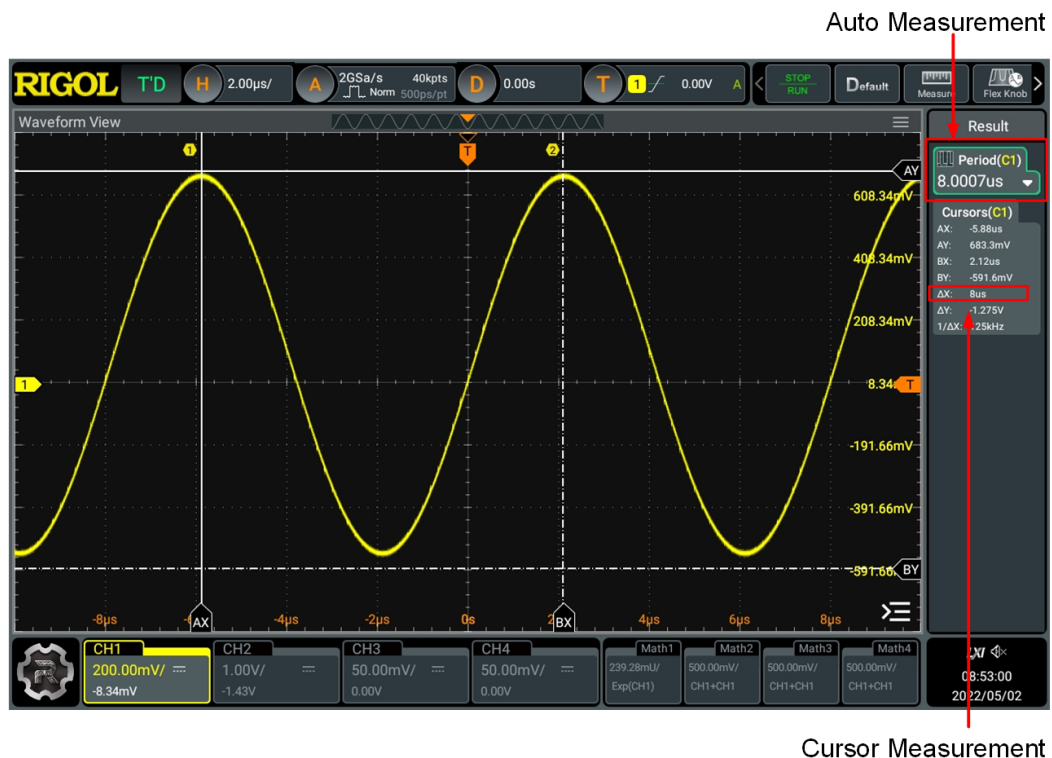

Figure 10.10 Manual Cursor Measurement Example

### Close the Cursor Measurement Result Window

In "Cursors" menu, click or tap **Remove** to close the cursor measurement result display window at the right side of the screen.

## 10.6.2 Track Mode

In the Track mode, you can adjust the two pairs of cursors (Cursor A and Cursor B) to measure the X and Y values on two different sources respectively. When the cursors are moved horizontally/vertically, the markers will position on the waveform automatically. When the waveform is expanded or compressed horizontally/vertically, the markers will track the points being marked at the last adjustment of the cursors.

In the **Cursors** menu, click or tap **Track** for the **Mode** item to enable the track cursor measurement function. The measurement results are displayed in the "Result" bar at the right section of the screen.

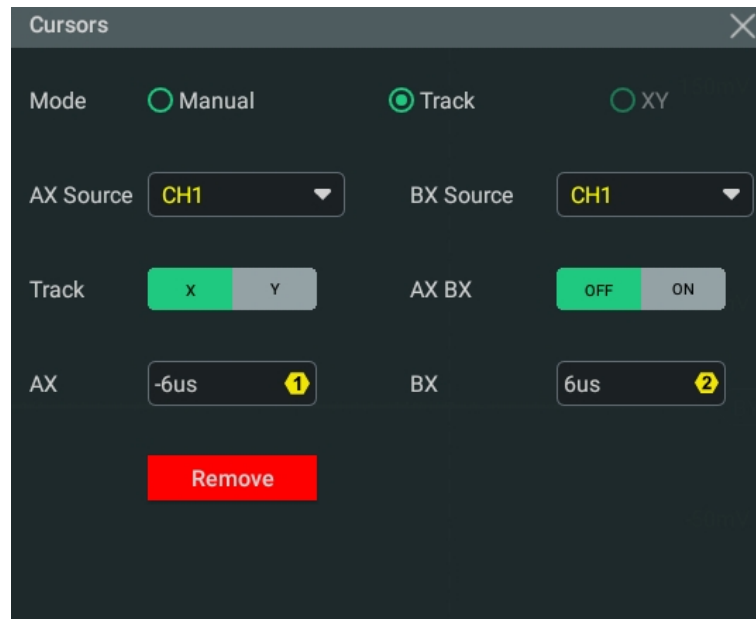

Figure 10.11 Track Mode Setting Menu

#### Select Measurement Source

- Click or tap the drop-down button of **AX Source** to select the desired channel (None, CH1~CH4, or Math1~Math4).
- Click or tap the drop-down button of **BX Source** to select the desired channel (None, CH1~CH4, or Math1~Math4).

If the specified channel is selected as the source, the channel will be enabled automatically.

#### Select the Track Mode

Click or tap the **Track** toggle button to select "X" or "Y" as the current track axis. By default, it is "X".

- **X:** When the X cursor position is adjusted, Y cursor will automatically track the intersection point between X cursor and source signal.
- **Y:** When the Y cursor position is adjusted, X cursor will automatically track the intersection point between Y cursor and source signal.

#### Adjust Cursor Position

- When "X" is selected, you can adjust the position of X cursor.
  - Click or tap the input field of **AX** and use the pop-up numeric keypad to set the horizontal position of Cursor A (X cursor). Its adjustable range is limited within the screen.

- Click or tap the input field of **BX** and use the pop-up numeric keypad to set the horizontal position of Cursor B (X cursors). Its adjustable range is limited within the screen.
- Click or tap the **AX BX** on/off switch to turn on/off adjusting the horizontal position of Cursor A and Cursor B (X cursors) simultaneously. The horizontal spacing between Cursor A and Cursor B (X cursors) remains unchanged.
- When "Y" is selected, you can adjust the position of Y cursor.
  - Click or tap the input field of **AY** and use the pop-up numeric keypad to set the vertical position of Cursor A (Y cursor).
  - Click or tap the input field of **BY** and use the pop-up numeric keypad to set the vertical position of Cursor B (Y cursor).
  - Click or tap the **AY BY** on/off switch to turn on/off adjusting the vertical position of Cursor A and Cursor B (Y cursors) simultaneously. The vertical spacing between Cursor A and Cursor B (Y cursors) remains unchanged.

You can also use the touch screen or the front-panel multipurpose knob  to adjust the cursor position. To configure the multipurpose knobs, please refer to *Front Panel Overview*.

### Measurement Example

Set the **AX source** to CH1, **BX source** to CH2, and **Track** to "X".

When the AX cursor position is adjusted, AY cursor will automatically track the intersection point between AX cursor and source signal (CH1); When the BX cursor position is adjusted, BY cursor will automatically track the intersection point between BX cursor and source signal (CH2). The measurement results are displayed in the "Result" bar, as shown in *Figure 10.12*. Then, expand the waveforms horizontally, and you will find that the cursor will track the point that has been marked, as shown in *Figure 10.13*.



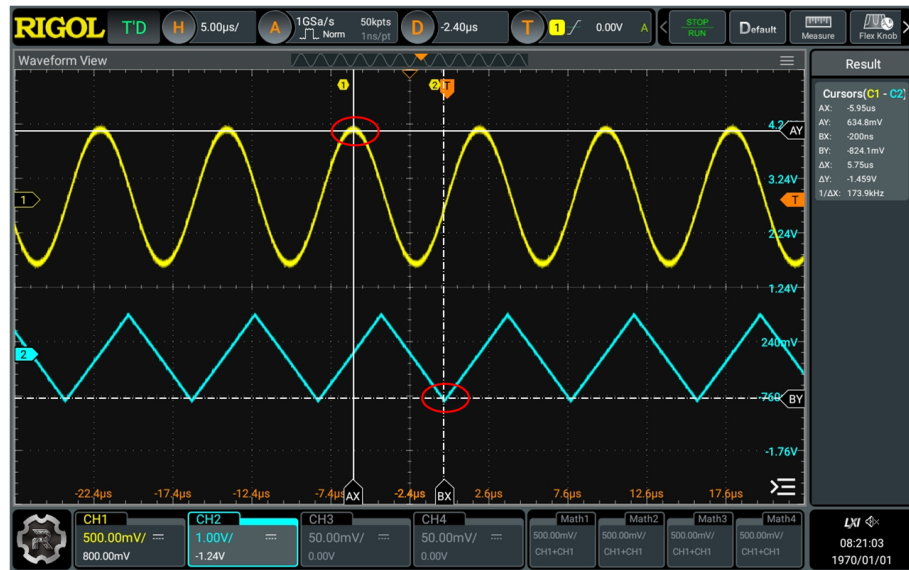

Figure 10.12 Track Measurement (before Horizontal Expansion)



Figure 10.13 Track Measurement (after Horizontal Expansion)

### Close the Cursor Measurement Result Window

In "Cursors" menu, click or tap **Remove** to close the cursor measurement result display window at the right side of the screen.

## 10.6.3 XY Mode

In the **Cursors** menu, click or tap **XY** for the **Mode** item to enable the XY cursor measurement function. The measurement results are displayed in the "Result" bar at the right section of the screen.

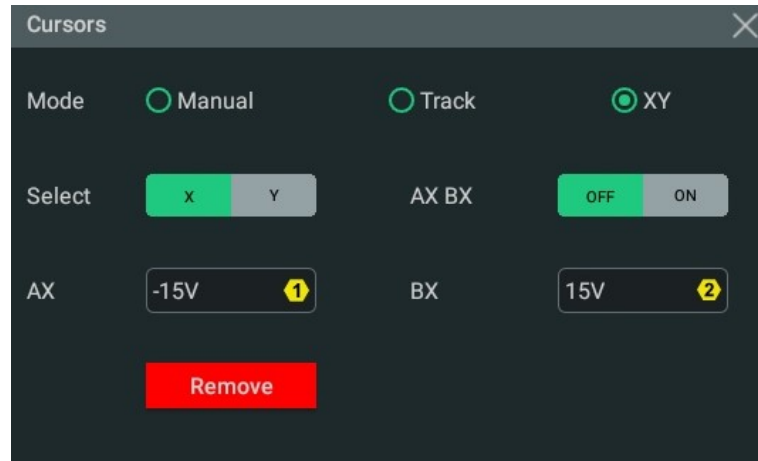



Figure 10.14 XY Mode

**TIP**

By default, XY mode is unavailable. It is available only when the horizontal time base mode is "XY". To enable the XY mode, please refer to [Enable the XY Mode](#).

**Adjust Cursor Position**

- Click or tap to select "X" under the **Select** item to set the X value for the specified cursor.
  - Click or tap the input field of **AX** and use the pop-up numeric keypad to set the X value at Cursor A.
  - Click or tap the input field of **BX** and use the pop-up numeric keypad to set the X value at Cursor B.
  - Click or tap the **AX BX** on/off switch to turn on/off adjusting the X value at Cursor A and the X value at Cursor B simultaneously.
- Click or tap to select "Y" under the **Select** item to set the Y value for the specified cursor.
  - Click or tap the input field of **AY** and use the pop-up numeric keypad to set the Y value at Cursor A.
  - Click or tap the input field of **BY** and use the pop-up numeric keypad to set the Y value at Cursor B.
  - Click or tap to the **AY BY** on/off switch to turn on/off adjusting the Y value at Cursor A and the Y value at Cursor B simultaneously.

You can also use the touch screen or the front-panel multipurpose knob  to adjust the cursor position. To configure the multipurpose knobs, please refer to [Front Panel Overview](#). During the adjustment, the measurement results will change accordingly. The adjustable range is limited within the screen.

### Close the Cursor Measurement Result Window



In "Cursors" menu, click or tap **Remove** to close the cursor measurement result display window at the right side of the screen.

# 11 Digital Voltmeter (DVM) and Frequency Counter

This series oscilloscope provides a built-in digital voltmeter (DVM) and frequency counter, which enable you to perform more accurate measurements, improving user experience in counter and frequency measurement.

## 11.1 Digital Voltmeter (DVM)

The built-in DVM of this oscilloscope provides 4-digit voltage measurements on any analog channel. DVM measurements are asynchronous from the oscilloscope's acquisition system and are always acquiring. You can enable the DVM measurements in the following ways.

- Click or tap the function navigation icon  > **DVM** to enable the DVM measurements.
- Click or tap the **DVM** button in the toolbar to enable the DVM measurements.
- Press the front-panel  key and then select **DVM** in the displayed "Analyse" menu to enable the DVM measurements.

After the DVM measurements are enabled, the "DVM" label displaying the current voltage value and voltage mode appears in the "Result" bar at the right section of the screen, as shown in the figure below.

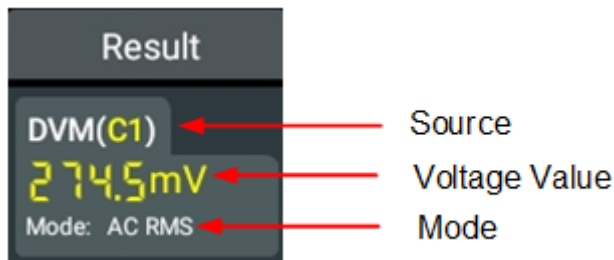

The specific value in the label shows the measurement extrema over the last 3 seconds.

Click or tap the "DVM" label and then a window is displayed. Click or tap **Setting** to enter the DVM setting menu as shown in *Figure 11.1*. You can click or tap **Remove** to disable the DVM measurements.

### 11.1.1 Measurement Settings

After the DVM is enabled, click or tap the "DVM" label in the "Result" bar at the right section of the screen and a window is displayed. Click or tap **Setting** in the window to enter the DVM setting menu, as shown in the figure below.

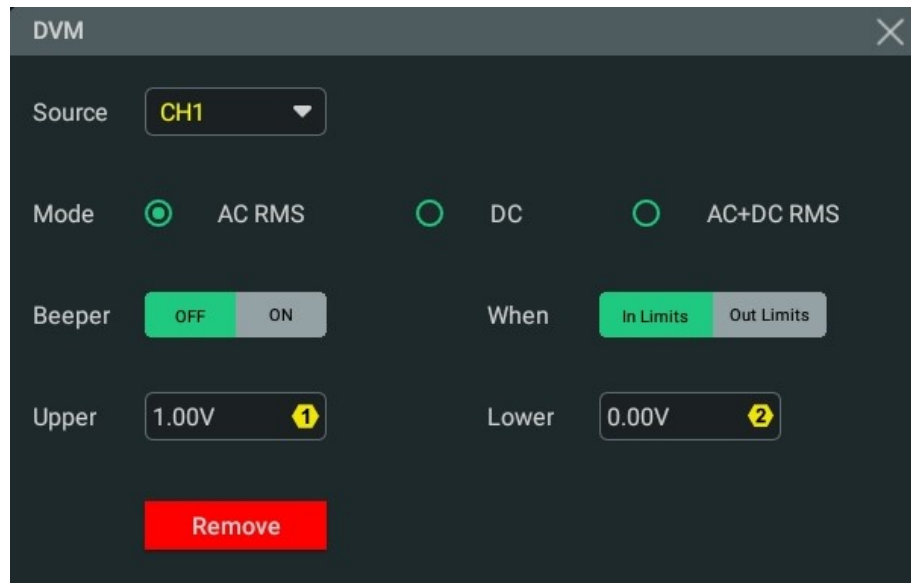

Figure 11.1 DVM Setting Menu

### Select the Measurement Source

Click or tap the **Source** drop-down button to select the desired source. The analog channel (CH1-CH4) can be selected to be the measurement source.

Even if the analog channel (CH1-CH4) is not enabled, you can still perform the DVM measurements.

### Select Measurement Mode

In the **Mode** item, you can select the DVM mode. The DVM measurement modes include AC RMS, DC, and AC+DC RMS.

- AC RMS: displays the root-mean-square value of the acquired data, with the DC component removed.
- DC: displays the average value of the acquired data.
- AC+DC RMS: displays the root-mean-square value of the acquired data.

### Set the Limits

When setting the limits, you can select when to turn on or off the beeper once it reaches the limit line.

- Limits Condition Setting

Click or tap the **When** toggle button to select "In Limits" or "Out Limits".

- In Limits: when the voltage value is inside the limited range, you can enable or disable the beeper to sound an alarm.

- Out Limits: when the voltage value is outside the limited range, you can enable or disable the beeper to sound an alarm.
- Upper/Lower Limit Setting

Click or tap the input field of **Upper**, then use the pop-up numeric keypad to set the upper limit of the voltage or use the corresponding multipurpose knob to set the value.

Click or tap the input field of **Lower**, and then use the pop-up numeric keypad to set the lower limit of the voltage or use the corresponding multipurpose knob to set the value.



### 11.1.2 Remove the Measurement

Click or tap the "DVM" label in the "Result" bar and a window is displayed. Click or tap **Remove** to disable the DVM measurements and clear the measurement results. You can also click or tap **Remove** in the DVM setting menu to disable the function.

## 11.2 Frequency Counter

The frequency counter analysis function provides frequency, period, or edge event counter measurements on any analog channel.

You can enable the counter in the following ways:

- Click or tap  > **Counter** to enable the counter.
- Click or tap the **Counter** button in the toolbar to enable the counter.
- Press the front-panel  key and then select **Counter** in the displayed "Analyse" menu to enable the counter.

After the counter is enabled, the "Counter" label displaying the counter measurement results appears in the "Result" bar at the right section of the screen, as shown in the figure below.

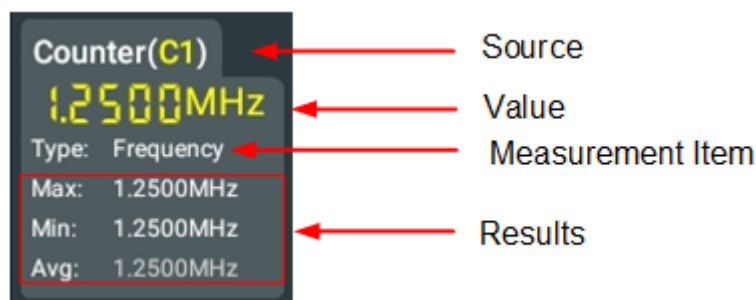

You can click or tap the "Counter" label in the "Result" bar and select **Reset Stat**, **Setting**, or **Remove** in the displayed window.

## 11.2.1 Measurement Settings

After the frequency counter is enabled, click or tap the "Counter" label in the "Result" bar at the right section of the screen and a window is displayed. Click or tap **Setting** in the window to enter the counter setting menu, as shown in the figure below.

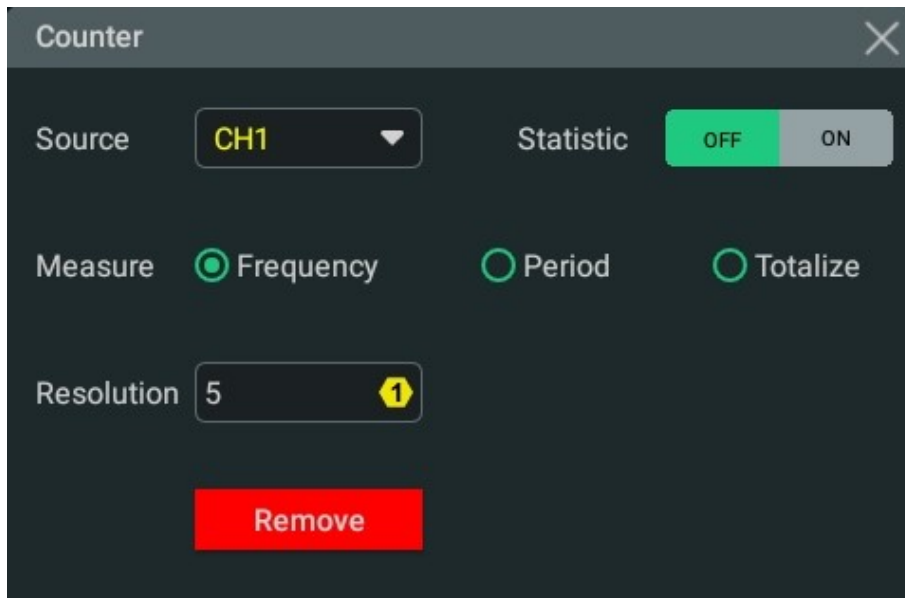

Figure 11.2 Frequency Counter Setting Menu

### Select the Measurement Source

Click or tap the drop-down button of **Source** to select the desired source. Analog channels (CH1-CH4) and EXT can be selected as the source of the frequency counter.

### Set Resolution

For Period and Frequency measurements, you need to set the readout resolution. Click or tap the input field of **Resolution** to set the resolution by using the pop-up numeric keypad. You can also use the corresponding multipurpose knob to set the value. The resolution ranges from 3 bits to 6 bits. By default, it is 5 bits.

The greater the resolution, the longer the gate time. In this way, the measurement time will be longer.

### Select the Measurement Item

In the **Measure** item, you can select the desired measurement item. Available options include Frequency, Period, and Totalize. Wherein, Totalize indicates the count of edge events on the signal.

### Clear Count

When "Totalize" is selected as the measurement item, the oscilloscope measures the count of edge events on the signal. At this time, you can click or tap **Clear Count** to clear the measurement results and measure again.

### Statistics Results

Click or tap the **Statistic** on/off switch to turn on/off displaying all statistical items. When enabled, all the statistical results will be displayed in the "Counter" label in the "Result" bar.

## 11.2.2 Reset Statistics

---

Click or tap the "Counter" label in the "Result" bar at the right section of the screen and a window is displayed. Click or tap **Reset Stat.** in the window to reset the statistics.

## 11.2.3 Remove the Measurement

---

Click or tap the "Counter" label in the "Result" bar and a window is displayed. Click or tap **Remove** to clear the measurement results. The "Counter" label disappears from the "Result" bar accordingly. You can also click or tap **Remove** in the counter setting menu to disable the function.





## 12 Reference Waveform

This series oscilloscope provides 10 reference waveform positions (Ref1~Ref10). In the actual test process, you can compare the signal waveform with the reference waveform to locate the failure.

### 12.1 To Enable Ref Function

You can enter the **Ref** menu in the following ways.

- Click or tap the function navigation icon  at the lower-left corner of the screen, and then select **Ref** to enter the reference waveform function menu.
- Press the front-panel  key to enter the reference waveform function menu.

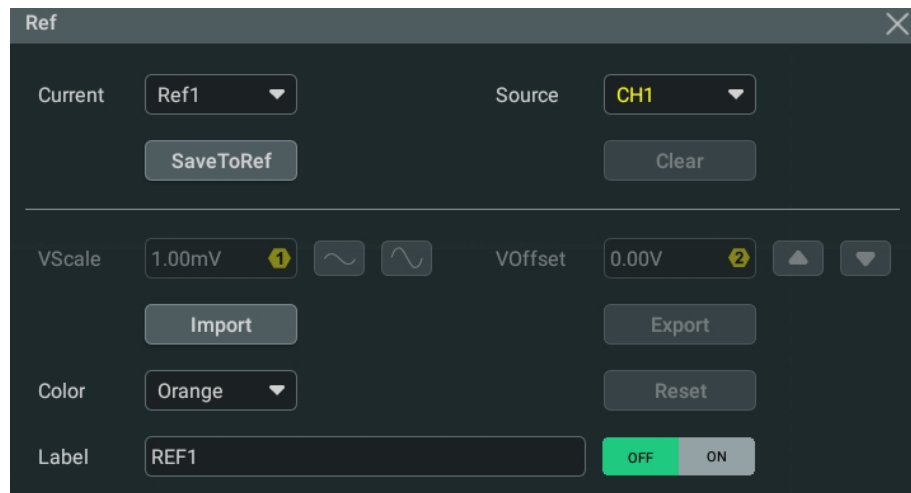

Figure 12.1 Reference Waveform Menu

When the Ref function is enabled, you can select different colors for reference waveforms, set the source of each reference channel, adjust the vertical scale and offset of the reference waveform, save the reference waveform to the internal or external memory, and recall it when necessary.

### 12.2 To Set the Reference Waveform

In the **Ref** menu, you can specify a channel to serve as the reference channel. You can save or clear the reference channel.

#### To Select the Reference Channel

Click or tap the drop-down button of **Current** to select the reference waveform channel (Ref1-Ref10). By default, Ref1 is enabled.

### To Select the Ref Source

Click or tap the drop-down button of **Source** to select the desired reference waveform source (CH1~ CH4 or Math1~ Math4).

### To Save the Reference Waveform to Internal Memory

Click or tap **SaveToRef** to save the displayed waveform for the specified source to the internal memory as the reference waveform.



#### CAUTION

**This operation only saves the reference waveform to the volatile memory, and the waveform will be cleared at power-off or restoring to the default settings. If you want to store reference waveforms that can be recalled when necessary, please export the waveform to internal or external memory (*To Export to Internal or External Memory*).**

### To Clear the Specified Reference Waveform

Click or tap **Clear** to clear the specified reference waveform for the "current channel".

You can also click or tap the **Clear** button in the function navigation menu or press

the front-panel  key to clear the reference waveforms of all the reference channels.

## 12.3 To Set the Ref Waveform Display

After clicking or tapping **SaveToRef**, you can adjust the vertical scale and offset of the reference waveform specified in **Current**.

### Modify the Vertical Scale

Click or tap the input field of **VScale**, and then use the pop-up numeric keypad to set the vertical scale of the reference waveform. You can directly click or tap the icons



at the right side of the input field of **VScale** to increase or decrease the vertical scale value. You can also use the corresponding multipurpose knob to adjust the scale.

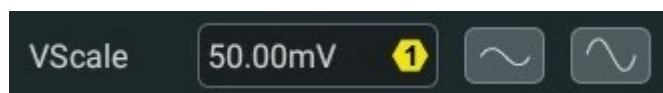

### Modify the Vertical Offset

Click or tap the input field of **VOffset**, and then use the pop-up numeric keypad to set the vertical offset of the reference waveform. You can directly click or tap the Up

and Down arrow icons  at the right side of the input field of **VOffset** to

increase or decrease the vertical offset value. You can also use the corresponding multipurpose knob to adjust the offset.



### Restore the Reference Waveform

If you have adjusted the vertical scale and offset for the specified reference waveform of the current channel, to reset the reference waveform to the position where the source channel stays prior to the **SaveToRef** operation, click or tap **Reset**.

### Set the Reference Waveform Color

This series oscilloscope provides five colors (gray, green, light blue, red, and orange) to mark the reference waveforms of different channels in order to distinguish them.

Click or tap the drop-down button of **Color** to select the color of the reference waveform of the channel.

### Set the Reference Waveform Label

Click or tap the **Label** on/off switch to enable or disable the label display of the specified reference waveform.

Click or tap the input field of **Label** to set the label of the specified reference channel with the pop-up numeric keypad.

## 12.4 Export and Import Operation

### To Export to Internal or External Memory

You can save the current reference waveform to the internal memory or external USB storage device. The file format of the reference waveform is "\*.ref", "\*.bin", or "\*.csv".

Click or tap **Export** to enter the reference waveform file saving interface.

- **Set the Format**

In the file saving interface, click or tap the drop-down button of **Format** to select "\*.ref", "\*.bin", or "\*.csv" as the saving format.

- **Set the Filename**

Click or tap the input field of **File Name**, then the filename editing interface is displayed. Input the filename with the pop-up numeric keypad. For the methods of using the numeric keypad, refer to descriptions in *Parameter Setting Method*.

- **Set the Save Path**

Click or tap the input field of **File Path**, then the disk management interface is displayed. Through the disk management menu, you can save the current

reference waveform to the internal memory or external USB storage device. Then click or tap **Save** to complete the save operation. For details about the disk management operation, refer to the *Disk Management* section in *Store and Load*.



#### TIP

Only when the reference waveform is saved, can this export function be valid.

This series oscilloscope only supports the flash memory USB storage device of FAT32 format.

For the ".bin" format file, refer to *Binary Data Format (.bin)*.

#### To Import from Internal or External Memory

You can import the stored reference waveform file from the internal memory or external USB storage device to the internal instrument and display the file on the screen.

Click or tap **Import** to enter the reference waveform file loading interface.

- **Set the Format**

In the file loading interface, click or tap the drop-down button of **Format** to select ".ref" as the loading format.



- **Set the Load Path**

Click or tap the input field of **File Path**, then the disk management interface is displayed.

Through the disk management menu, you can load the current reference waveform to the waveform view of the oscilloscope. Then click or tap **Load** to complete the load operation. For details about the disk management operation, refer to the *Disk Management* section in *Store and Load*.

## 13 Pass/Fail Test

During the product design and manufacturing process, you usually need to monitor the variations of the signal or judge whether the product is up to standard. The pass/fail test function of this series oscilloscope can accomplish this task perfectly. It compares the signal under test with "standard" waveforms and display the test results based on user-defined test rules. When the pass/fail status is detected, you can choose to stop monitoring, sound an alarm with the beeper, or save the current screen image.

Click or tap the function navigation icon  at the lower-left corner of the screen to open the function navigation. Then click or tap the **Pass/Fail** button to enter the "PassFail" setting menu. You can also press the front-panel  key and select **Pass/Fail** to enter the "PassFail" setting menu. The menu is as shown in the figure below.

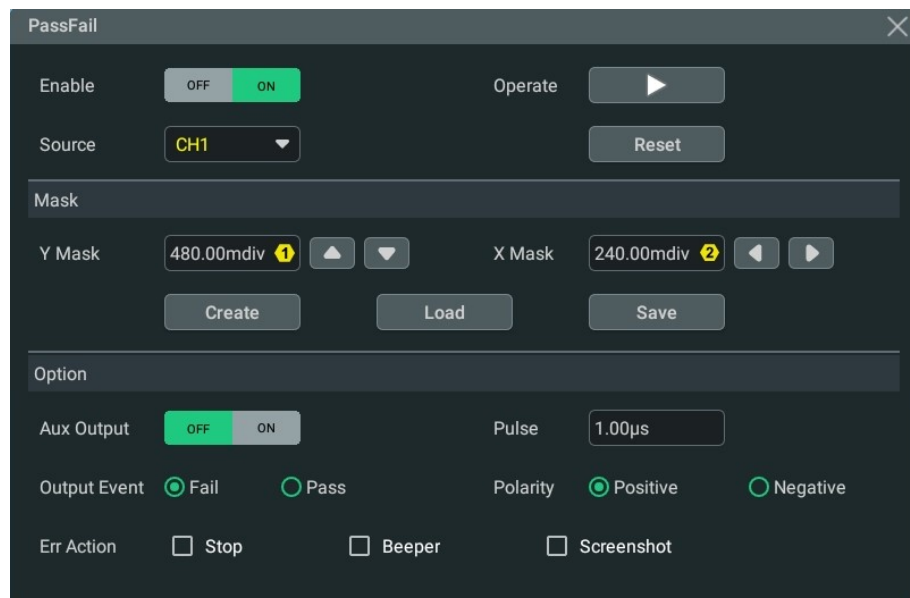

Figure 13.1 Pass/Fail Test Menu

### 13.1 To Enable or Disable the Pass/Fail Test Function

In the "Pass/Fail" setting menu, click or tap the **Enable** on/off switch to enable or disable the pass/fail test function.

You can select the source, create mask, and set test result output only after the pass/fail test function is enabled.

## 13.2 To Select the Source

Click or tap the drop-down button of **Source** to select the desired source. The available output channels include CH1-CH4.



### TIP

When a disabled channel is selected as the source, it will be automatically turned on.

## 13.3 To Create a Mask

In the **Pass/Fail** menu, you can self-define the mask of the pass/fail test. The mask can be imported or exported.

### To Create a Mask

Click or tap **X Mask** and **Y Mask** respectively to set the horizontal tolerance range and vertical tolerance range with the pop-up numeric keypad. You can also use the icons at the right side of the input fields or use the corresponding multipurpose knob to set the values. Then click or tap **Create** to apply the currently created mask (the region not covered by blue within the screen).

### To Load a Mask

When the pass/fail test function is enabled, you can load the test mask files from the internal memory or external USB storage device (when detected) and apply them to the current pass/fail test function.

Click or tap **Load** to enter the file loading interface. Click or tap the input field of **File Path** to load the specified test mask files (in \*.pf format) and apply them to the current pass/fail test function. For details, refer to descriptions in *Disk Management* section in *Store and Load*.

### To Save the Mask

When the pass/fail test function is enabled, you can save the current test mask range to the internal memory or external USB storage device (when detected) in "\*.pf" format.

Click or tap **Save** to enter the file saving interface. Click or tap the input field of **File Name** and **File Path** to input the filename and select the desired file path to save the test mask file to the internal or external memory. For details, refer to descriptions in *Disk Management* section in *Store and Load*.

## 13.4 To Set the Output Form of the Test Results

In **Option**, you can set what the oscilloscope will execute when test results are detected according to your needs.

### Set the output event and Aux output

- Click or tap the **Aux Output** on/off switch to enable or disable the Aux output. When enabled, in the **Utility** menu, the sub-menu **AUX Out** is automatically set to "PassFail". When a successful or failed event is detected, a pulse will be output from the rear-panel **[AUX OUT]** connector. If disabled, the sub-menu **AUX Out** in the **Utility** menu is automatically set to "TrigOut", and the output of the **[AUX OUT]** connector is irrelevant with the pass/fail test.
- Select "Pass" or "Fail" in **Output Event**. When a "pass" or "fail" event is detected, a pulse will be output from the rear-panel **[AUX OUT]** connector.

### Set the output polarity and output pulse width

Select "Positive" or "Negative" in **Polarity**, then click or tap the input field of **Pulse** to set the pulse width with the pop-up numeric keypad. You can also use the corresponding multipurpose knob to set the value. Its range is from 100 ns to 10 ms. By default, it is 1  $\mu$ s.

### Set the error action

In **Err Action**, select one operation that the oscilloscope will execute once a pass/fail test is detected.

- **Stop:** stop sampling when a failed event is found.
- **Beeper:** the beeper sounds an alarm when a failed event is found (irrelevant with the on/off status of the beeper).
- **Screenshot:** perform the screenshot operation when a failed event is found. If an external storage device is detected, the screenshot will be saved to the external storage device directly. Otherwise, it will be saved to the local disk.

If "Screenshot" is selected, "Stop" action will be executed forcibly. The sampling stops automatically. After the Screenshot operation is completed, the sampling will continue.

## 13.5 To Start or Stop the Pass/Fail Test Operation

After the Pass/Fail test function is enabled, click or tap the **Operate** button



to start the test operation or

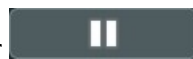

to stop the operation.

During the test process, the oscilloscope will test the waveforms, display the test information, and output the test information based on the current of settings. The "**Pass/Fail**" result will be displayed in the "Result" bar at the right side of the screen, as shown in the figure below.

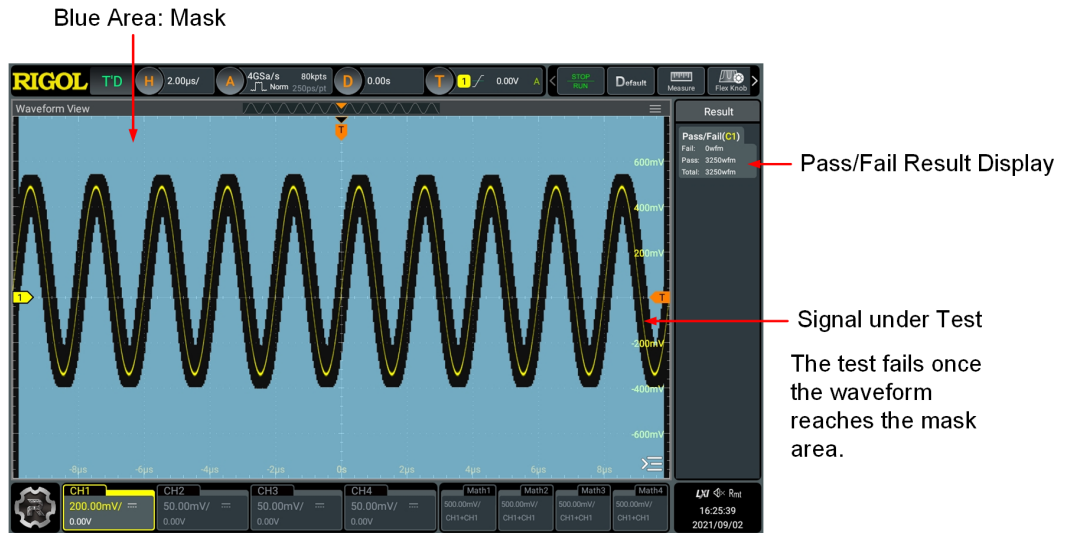



Figure 13.2 Pass/Fail Test Interface

**TIP**

- Only when the pass/fail test function is enabled, can you start or stop the pass/fail test operation, save and recall the test mask range.
- After starting the test operation, you can neither modify the source channel nor adjust the test mask.

## 13.6 Display the Statistics of the Test Results

After the "Pass/Fail" function is enabled, the test results will be displayed in the

"Result" bar at the right side of the screen. You can click or tap the icon  at the lower-right corner of the screen to hide the "Result" sidebar.

The test results statistics include the number of failed frames, the number of successful frames, and total number of frames, as shown in the figure below.

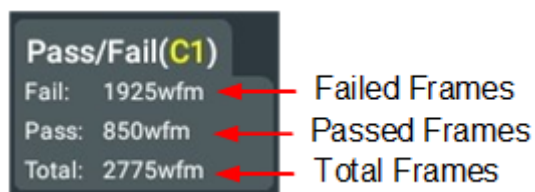

Click or tap the "Pass/Fail" label and a window is displayed for you to perform the following operations.

- Click or tap **Reset Stat.**, then the statistics in the "Pass/Fail" label will be reset to 0.
- Click or tap **Setting**, then the **PassFail** setting menu is displayed.



- Click or tap **Remove**, then the pass/fail function is disabled.

## 14 Protocol Decoding

You can use the protocol analysis to discover errors, debug hardware, and accelerate development easily, ensuring you to accomplish the projects with high speed and good quality. Protocol decoding is the basis of protocol analysis. Only protocol analyses with correct protocol decoding are acceptable, and only correct protocol decoding can identify more error information. This oscilloscope provides four bus decoding modules (Decode 1, Decode 2, Decode 3, and Decode 4) to make common protocol decoding for the input signals of the analog channels. It provides standard serial decodes including Parallel, RS232/UART, I2C, SPI, LIN, and CAN. As the decoding functions and setting methods of Decode1, Decode2, Decode3, and Decode4, this chapter takes Decode1 as an example for illustration.

- Click or tap  > **Decode** to enter the "Decode" menu.
- Click or tap the **Decode** button in the toolbar to enter the "Decode" menu.

### 14.1 Parallel Decoding

Parallel bus consists of clock line and data line. As shown in the figure below, CLK is the clock line, whereas Bit0 and Bit1 are the 0 bit and 1st bit on the data line respectively. The oscilloscope will sample the channel data on the rising edge, falling edge, or the rising/falling edge of the clock and judge each data point (logic "1" or logic "0") according to the preset threshold level.

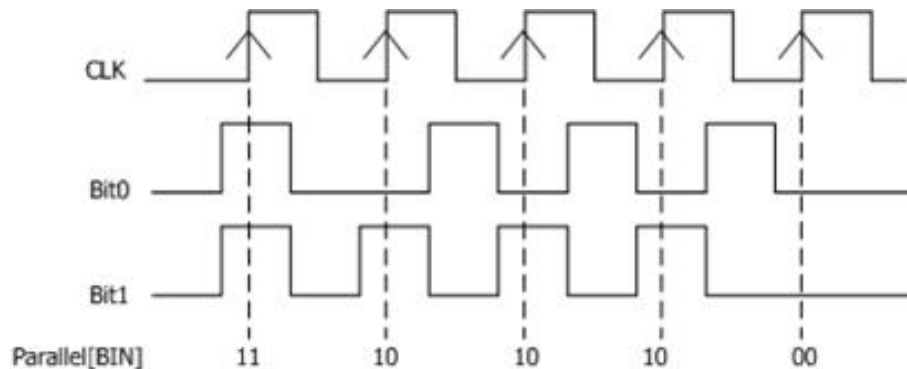

Figure 14.1 Schematic Diagram of Parallel Decoding

In the **Decode** menu, click or tap the drop-down button of **Bus Type** to select **Parallel**, then configure the parameters for Parallel decoding.

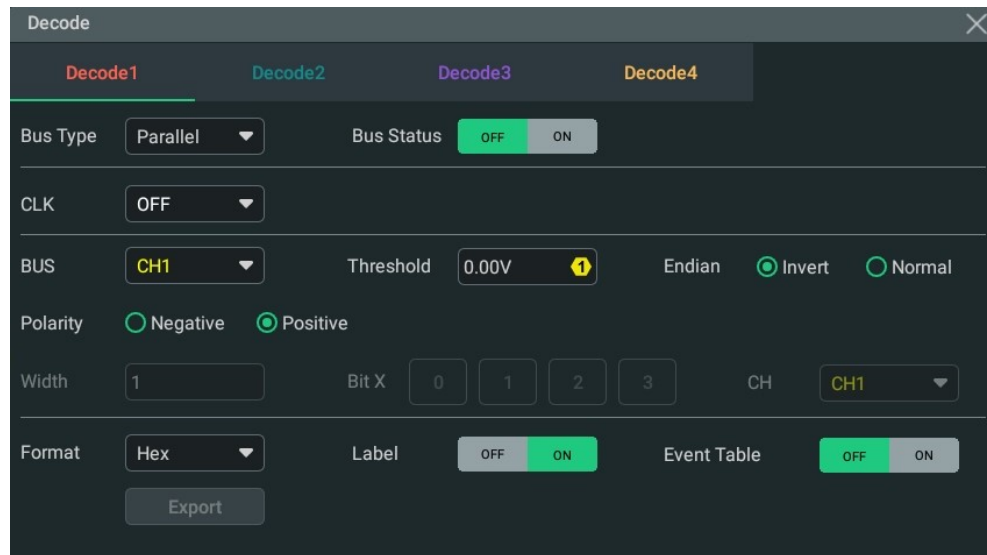

Figure 14.2 Parallel Decoding Menu

### Bus Status

Click or tap the **Bus Status** on/off switch to enable or disable the bus decoding.

## 14.1.1 Clock Setting (CLK)

### Clock Setting (CLK)

Click or tap the drop-down button of **CLK** select the desired source of the clock channel (CH1-CH4) from the drop-down list. If "OFF" is selected, no clock channel is set, and sampling is performed when a hop occurs to the data of the data channel during decoding.

### Threshold

When the clock signal is an analog channel (CH1-CH4), you need to set a threshold. Click or tap the input field of **Threshold**, and then use the pop-up numeric keypad to set the threshold. You can also use the corresponding multipurpose knob to set the value. The range of the threshold is related to the current vertical scale and offset.

### CLK Edge

When the clock channel is set to an analog channel (CH1-CH4), you can select "Rising", "Falling", or "Both" in **CLK Edge**.

- **Rising:** samples the channel data on the rising edge of the clock.
- **Falling:** samples the channel data on the falling edge of the clock.
- **Both:** samples the channel data on the rising edge or the falling edge of the clock.

## 14.1.2 Bus Setting

### Set the Bus

Click or tap drop-down button of **BUS** to select the digital bus (CH1-CH4) for Parallel decoding. You can also self-define the bus.

**Table 14.1 Bus Setting**

Bus	Width	Bit X	Channel	Remarks
CH1	1	0	CH1	Width, Bit X, and CH are set automatically, and you cannot modify them.
CH2	1	0	CH2	Width, Bit X, and CH are set automatically, and you cannot modify them.
CH3	1	0	CH3	Width, Bit X, and CH are set automatically, and you cannot modify them.
CH4	1	0	CH4	Width, Bit X, and CH are set automatically, and you cannot modify them.
User	1 (Default) to 4	0 (Default)	CH1~CH4	-

### Set the Threshold Level

To judge logic "1" and logic "0" of the buses, you need to set a threshold for each analog channel (CH1~ CH4). When the channel signal amplitude is greater than the preset threshold, it is judged as logic "1"; otherwise logic "0".

Click or tap the input field of **Threshold**, and then use the pop-up numeric keypad to set the threshold. You can also use the corresponding multipurpose knob to set the value. The range of the threshold is related to the current vertical scale and offset.

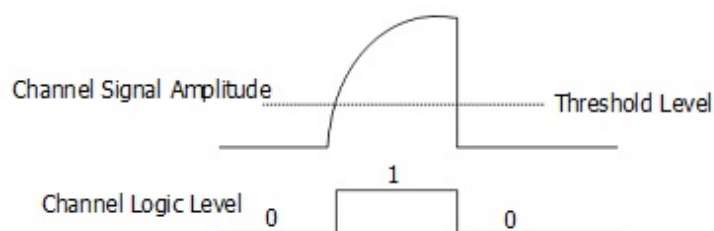

### Endian

In **Endian**, select "Invert" or "Normal" as the endian of the bus.

### Polarity

In **Polarity**, select "Positive" or "Negative" as the data polarity.

### 14.1.3 Display-related Settings

In **Decode** menu, set the following display-related parameters.

#### Set the Display Format

Click or tap the drop-down button of **Format** to select the display format of the bus data. The available options include "Hex", "Dec", "Bin", and "ASCII".

#### Set the Label Display

Click or tap the **Label** on/off switch to enable or disable the label display of the decoding bus. When enabled, the bus label will be displayed at the upper-left side of the bus (when the bus display is enabled). The label shows the current bus type.

### 14.1.4 Event Table

The event table displays the decoded data and the corresponding decoding information in time order in the form of a table. It can be used to observe relatively longer decoded data. The decoding information includes the decoded data, the corresponding line number, and time information.

#### Open or Close the Event Table

Click or tap the **Event Table** on/off switch to enable or disable the display of the event table. When enabled, the event table is displayed as shown in the figure below.

You can also click or tap the icon  at the upper-right corner of the table to close the event table.

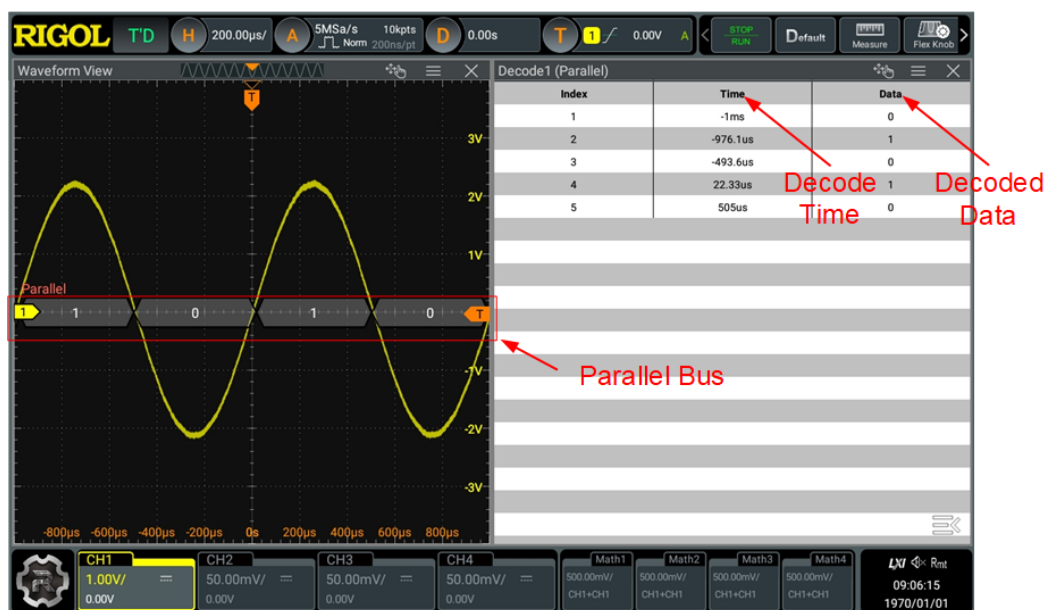

Figure 14.3 Parallel Decoding Event Table

**TIP**

- When you adjust the horizontal time base, the waveform displayed on the screen will also change, and the total number of lines containing the decoding information in the event table will also be changed.
- The displayed decoded data information in the bus is related to the value of the horizontal time base. Reducing the horizontal time base can help you view the detailed information.

**Set the Event Table Format**

In the Decode menu, click or tap the drop-down button of **Format** to select the display format of "Data" in the event table. The available options include "**Hex**", "**Dec**", "**Bin**", or "**ASCII**".

## 14.2 RS232 Decoding

RS232 serial bus consists of the transmitting data line (TX) and the receiving data line (RX).

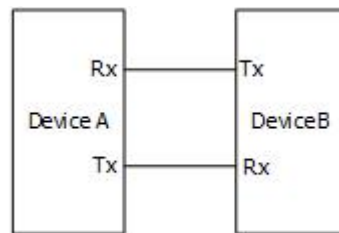

**Figure 14.4 Schematic Diagram of RS232 Serial Bus**

The industry standard of RS232 uses "Negative Logic", i.e. high level is logic "0" and low level is logic "1".

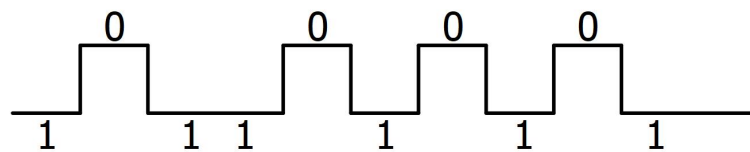

**Figure 14.5 Schematic Diagram of Negative Logic**

In RS232, baud rate is used to represent the transmission rate (namely bits per second) of the data. You need to set the start bit, data bits, check bit (optional), and stop bits for each frame of data.

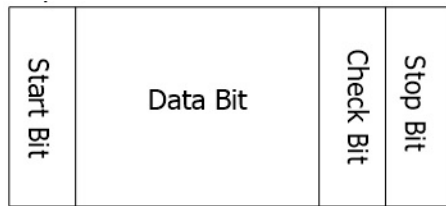

- **Start Bit:** indicates when to output data.
- **Data Bit:** indicates the number of data bits actually contained in each frame of data.
- **Check Bit:** used to check whether the data are properly transmitted.
- **Stop Bit:** indicates when to stop outputting data.

In the **Decode** menu, click or tap the drop-down button of **Bus Type** to select **RS232**, then configure the parameters for RS232 decoding.

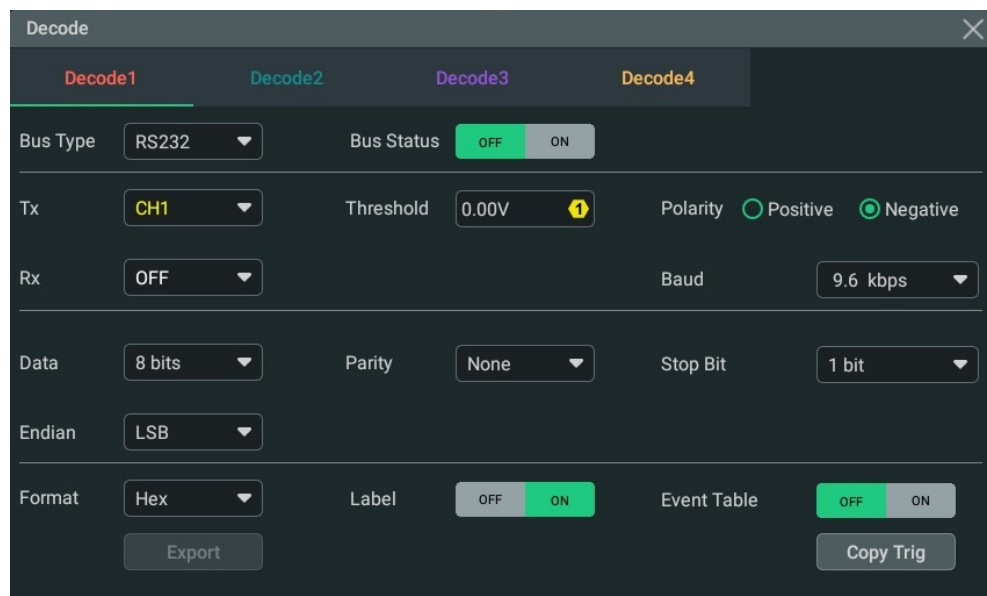

Figure 14.6 RS232 Decoding Menu

### Bus Status

Click or tap the **Bus Status** on/off switch to enable or disable the bus decoding.

### Quickly apply trigger settings to decoding

Copy trig indicates applying the trigger settings to the specified decoding setting.

Click or tap **Copy Trig** to apply the trigger settings to the specified decoding setting.

## 14.2.1 Source Setting

### Set the Tx source and the threshold

Click or tap drop-down button of **Tx** to select the desired source. The sources include CH1-CH4.

Click or tap the input field of **Threshold**, and then use the pop-up numeric keypad to set the threshold of Tx source. You can also use the corresponding multipurpose knob to set the value. The range is from -1.00 V to 1.00 V. Its default value is 0 V.

When you modify the threshold of the Tx source channel, a dotted line displaying the current threshold level is displayed on the screen. It disappears in about 2 s after you stop modifying the threshold.

### Set the Rx source and the threshold

Use the same method to select the **Rx** source and set the threshold. The default state of **Rx** is OFF.

### Polarity

Select "Positive" or "Negative" in **Polarity**.

- **Positive:** Uses negative logic. High level is logic "0" and low level is logic "1".
- **Negative:** Uses positive logic. High level is logic "1" and low level is logic "0".

### Set the baud rate

Click or tap the drop-down button of **Baud** to select the preset baud rate. The available baud rates include 50 bps, 75 bps, 110 bps, 134 bps, 150 bps, and etc.

The oscilloscope allows you to self-define the baud rate. Click or tap the drop-down button of **Baud** to select "User" and then set the baud rate with the pop-up numeric keypad.

## 14.2.2 To Set Data Package

### Data

Click or tap the drop-down button of **Data** to select the data bits. The available data bits are 5 bits, 6 bits, 7 bits, 8 bits, and 9 bits.

### Parity

It is used to check whether the data transmission is correct. Click or tap the drop-down button of **Parity** to select the desired parity mode.

- **None:** indicates that no check bit appears during the transmission.



- **Even:** indicates that the total number of "1" in the data bit and check bit is an even number. For example, when 0x55 (01010101) is sent, "0" should be added to the check bit.
- **Odd:** indicates that the total number of "1" in the data bit and check bit is an odd number. For example, when 0x55 (01010101) is sent, "1" should be added to the check bit.

### Stop Bit

Click or tap the drop-down button of **Stop Bit** to set the stop bits after each frame of data. It can be set to 1 bit, 1.5 bits, or 2 bits.

### Endian

Click or tap the drop-down button of **Endian** to select the desired endian.

- **LSB:** indicates Least Significant Bit transmission sequence, i.e. the lowest bit of the data is transmitted first.
- **MSB:** indicates Most Significant Bit transmission sequence, i.e. the highest bit of the data is transmitted first.

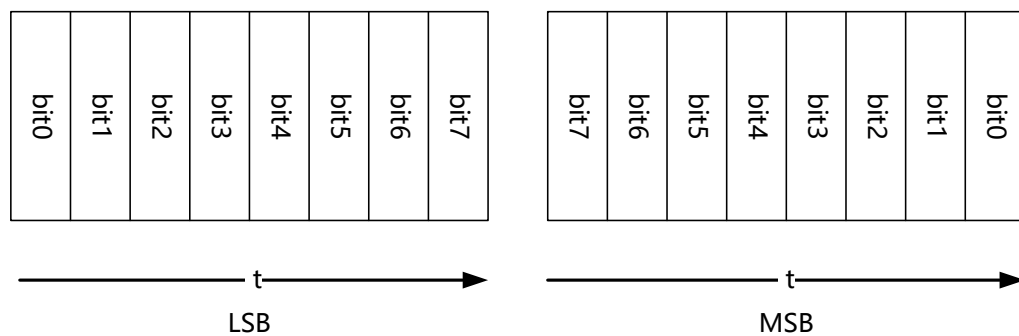

## 14.2.3 Display-related Settings

In **Decode** menu, set the following display-related parameters.

### Set the Display Format

Click or tap the drop-down button of **Format** to select the display format of the bus data. The available options include "Hex", "Dec", "Bin", and "ASCII".

### Set the Label Display

Click or tap the **Label** on/off switch to enable or disable the label display of the decoding bus. When enabled, the bus label will be displayed at the upper-left side of the bus (when the bus display is enabled). The label shows the current bus type.

## 14.2.4 Event Table

Click or tap the **Event Table** on/off switch to enable or disable the display of the event table. When enabled, the event table is displayed as shown in the figure below.

You can also click or tap the icon  at the upper-right corner of the table to close the event table.

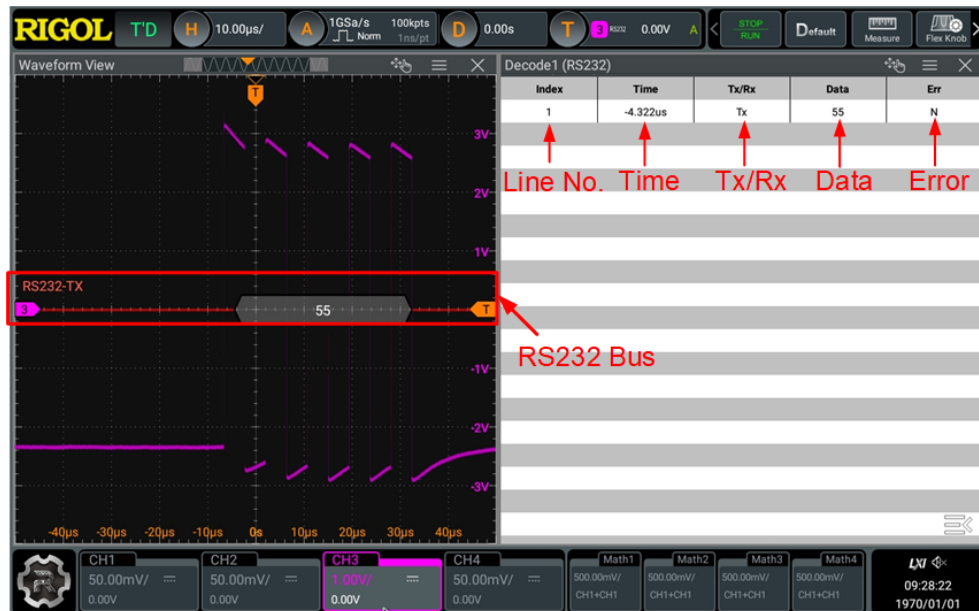

Figure 14.7 RS232 Decoding Event Table



### TIP

- When you adjust the horizontal time base, the waveform displayed on the screen will also change, and the total number of lines containing the decoding information in the event table will also be changed.
- The displayed decoded data information in the bus is related to the value of the horizontal time base. Reducing the horizontal time base can help you view the detailed information.

### Set the Event Table Format

In the Decode menu, click or tap the drop-down button of **Format** to select the display format of "Data" in the event table. The available options include "**Hex**", "**Dec**", "**Bin**", or "**ASCII**".

## 14.3 I2C Decoding

I2C serial bus consists of the clock line (SCL) and the data line (SDA).

**SCL:** samples SDA on the of rising or falling edge of the clock.

**SDA:** indicates the data channel.

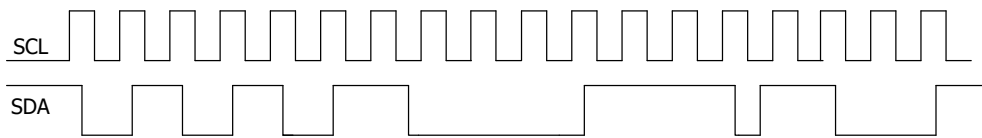

Figure 14.8 I2C Serial Bus

In the **Decode** menu, click or tap the drop-down button of **Bus Type** to select **I2C**, then configure the parameters for I2C decoding.

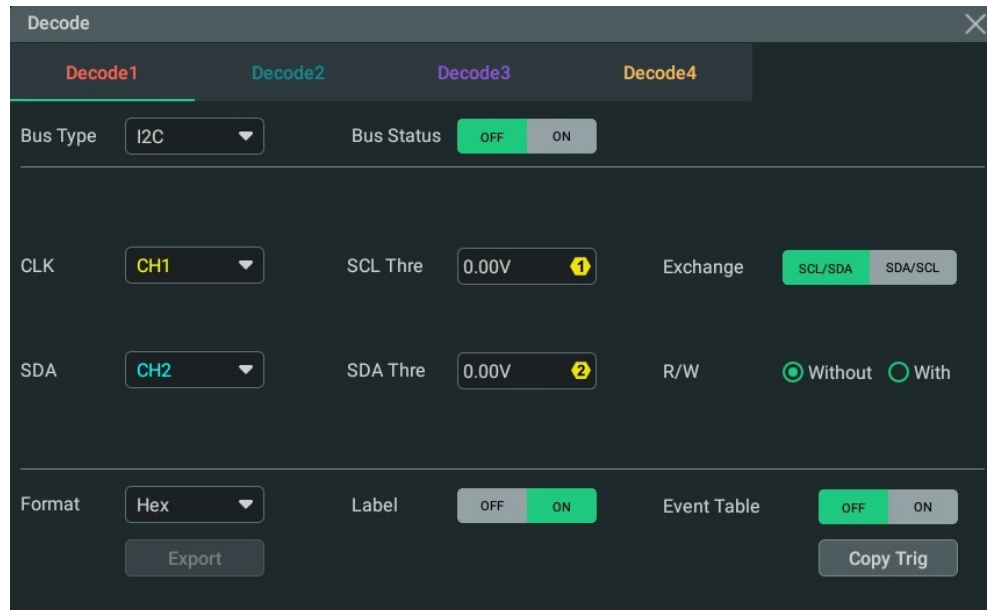

Figure 14.9 I2C Decoding Menu

### Bus Status

Click or tap the **Bus Status** on/off switch to enable or disable the bus decoding.

### Quickly apply trigger settings to decoding

Copy trig indicates applying the trigger settings to the specified decoding setting.

Click or tap **Copy Trig** to apply the trigger settings to the specified decoding setting.

## 14.3.1 Source Setting

### Set the clock channel source and the threshold

- Click or tap the drop-down button of **CLK** to select the desired source of the clock channel (CH1-CH4).
- Click or tap the input field of **SCL Thre**, and then use the pop-up numeric keypad to set the threshold of the clock channel.

When you modify the threshold of the clock channel, a dotted line displaying the current threshold level is displayed on the screen. It disappears in about 2 s after you stop modifying the threshold.

#### Set the data channel source and the threshold

- Click or tap the drop-down button of **SDA** to select the desired source of the data channel (CH1-CH4).
- Click or tap the input field of **SDA Thre**, and then use the pop-up numeric keypad to set the threshold of the data channel. You can also use the corresponding multipurpose knob to set the value.

#### Exchange Sources

Select "SCL/SDA" or "SDA/SCL" in **Exchange** to exchange the sources of the current clock channel and data channel.

#### Specify whether the address information includes the "R/W" bit

For I2C bus, each frame of data starts with the address information. The address information includes the read address and the write address.

Select "Without" or "With" in **R/W** to decide whether the address information includes the "R/W" bit. When "**With**" is selected, the "R/W" bit will be included in the address information and located at the lowest bit; when "**Without**" is selected, the "R/W" bit will not be included in the address information.

## 14.3.2 Display-related Settings

In **Decode** menu, set the following display-related parameters.

#### Set the Display Format

Click or tap the drop-down button of **Format** to select the display format of the bus data. The available options include "**Hex**", "**Dec**", "**Bin**", and "**ASCII**".

#### Set the Label Display

Click or tap the **Label** on/off switch to enable or disable the label display of the decoding bus. When enabled, the bus label will be displayed at the upper-left side of the bus (when the bus display is enabled). The label shows the current bus type.

## 14.3.3 Event Table

#### Open or Close the Event Table

Click or tap the **Event Table** on/off switch to enable or disable the display of the event table. When enabled, the event table is displayed as shown in the figure below.

You can also click or tap the icon  at the upper-right corner of the table to close the event table.

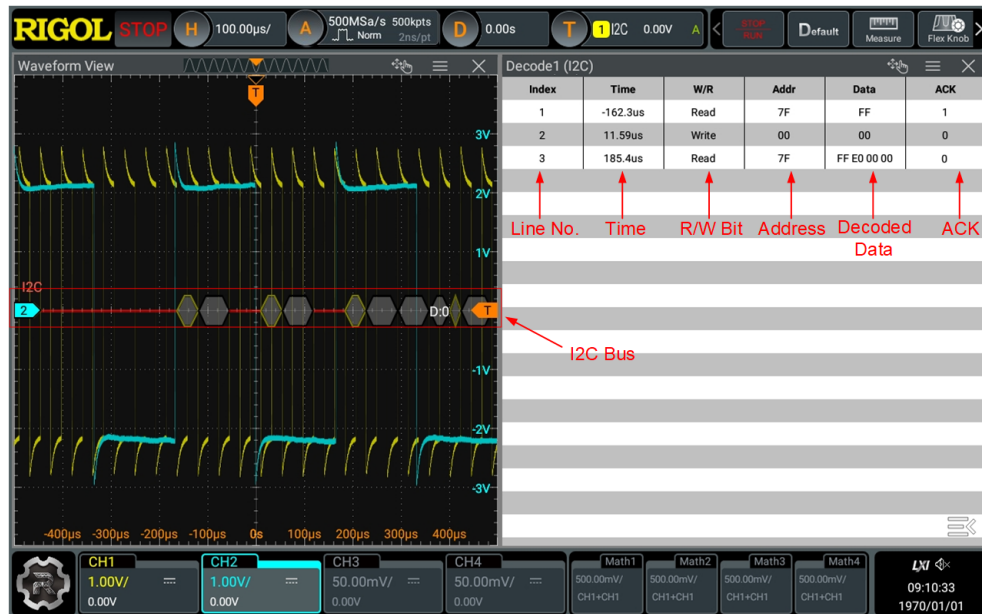

Figure 14.10 I2C Decoding Event Table

**TIP**

- When you adjust the horizontal time base, the waveform displayed on the screen will also change, and the total number of lines containing the decoding information in the event table will also be changed.
- The displayed decoded data information in the bus is related to the value of the horizontal time base. Reducing the horizontal time base can help you view the detailed information.

**Set the Event Table Format**

In the Decode menu, click or tap the drop-down button of **Format** to select the display format of "Data" in the event table. The available options include "**Hex**", "**Dec**", "**Bin**", or "**ASCII**".

**Address information in decoding**

For I2C bus, each frame of data starts with the address information (read address and write address). In the address information, "Read" indicates the read address

(**Read:7f**) and "Write" indicates the write address (**Write:1c**). You can decide whether to include or exclude the "R/W" bit for the address information.

**Error expressions in decoding**

In I2C decoding, when ACK (acknowledgment) is 1, ACK error occurs. When the

detected ACK is 1, red error report information (**ACK:1**) (the display form is related to the value of the horizontal time base) is displayed.

## 14.4 SPI Decoding

SPI bus is based on the master — slave configuration and usually consists of chip select line (CS), clock line (CLK), and data line (SDA). Wherein, the data lines include the master input/slave output (MISO) data line and master output/slave input (MOSI) data line. The oscilloscope samples the channel data on the rising or falling edge of the clock signal (if the source is an analog channel, the oscilloscope will also judge each data point (logic "1" or logic "0") according to the preset threshold level).

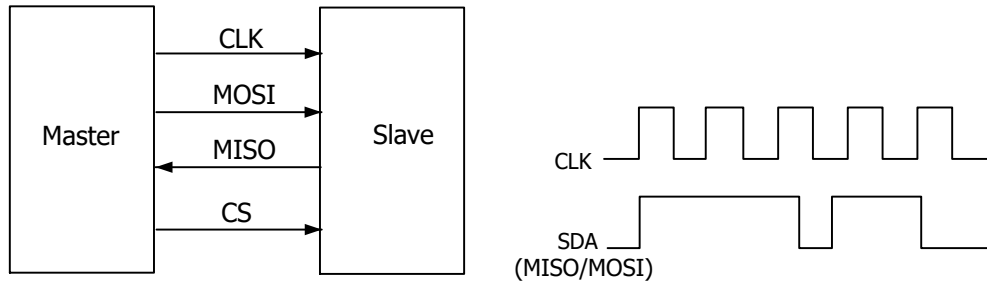

Figure 14.11 SPI Serial Bus

In the **Decode** menu, click or tap the drop-down button of **Bus Type** to select **SPI**, then configure the parameters for SPI decoding.

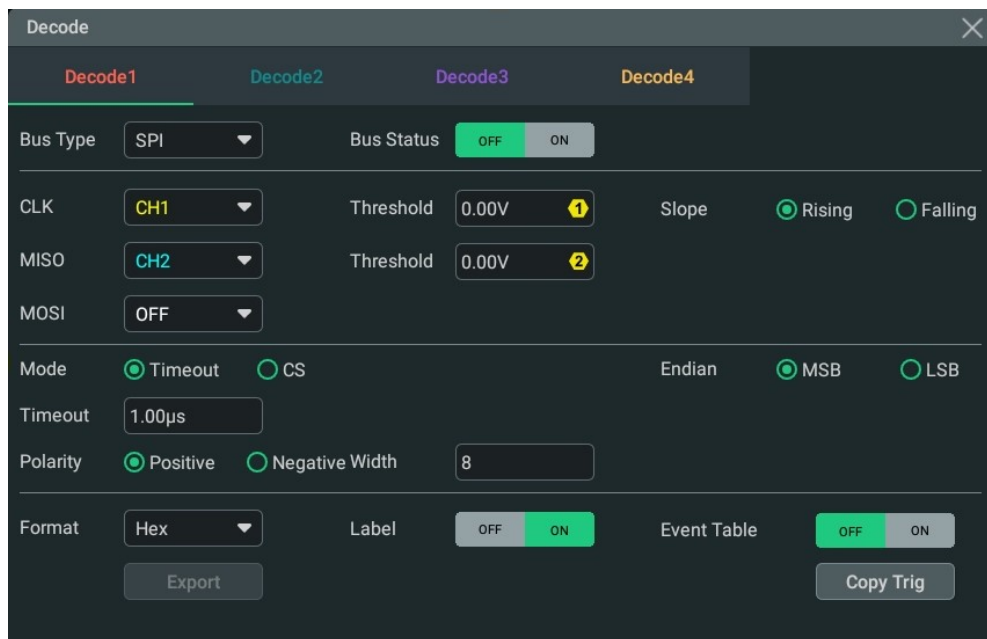

Figure 14.12 SPI Decoding Menu

### Bus Status

Click or tap the **Bus Status** on/off switch to enable or disable the bus decoding.

### Quickly apply trigger settings to decoding

Copy trig indicates applying the trigger settings to the specified decoding setting.

Click or tap **Copy Trig** to apply the trigger settings to the specified decoding setting.

## 14.4.1 To Set the Source

### Set the Clock Signal

- Click or tap the drop-down button of **CLK** to select the desired source of the clock channel. The sources include CH1-CH4.
- Click or tap the input field of **Threshold** at the right side of the **CLK** menu, and then use the pop-up numeric keypad to set the threshold of the clock channel. You can also use the corresponding multipurpose knob to set the value.
- Select "**Rising**" or "**Falling**" in **Slope** to set the instrument to sample MISO and MOSI on the CLK.

### MISO and MOSI Setting

- Click or tap drop-down button of **MISO** to select the desired source of MISO. The sources include CH1-CH4.
- Click or tap the input field of **Threshold** at the right side of **MISO**, and then use the pop-up numeric keypad to set the threshold of the MISO channel. You can also use the corresponding multipurpose knob to set the value.
- Click or tap drop-down button of **MOSI** to select the desired source of MOSI. The sources include CH1-CH4 and OFF.

## 14.4.2 To Set Mode and Data

### Mode

Select "**Timeout**" or "**CS**" in **Mode**.

- **Timeout:**

You can perform frame synchronization according to the timeout, and the timeout value must be greater than half of the clock cycle. Click or tap the input field of **Timeout**, and then use the pop-up numeric keypad to set the timeout value. You can also use the corresponding multipurpose knob to set the value. The adjustable range of the timeout value is from 8 ns to 10 s. By default, it is 1  $\mu$ s.

- **CS:**

It contains a chip select line (CS). You can perform frame synchronization according to CS. When "CS" is selected,

- Click or tap drop-down button of **CS** to select the desired source. The sources include CH1-CH4.
- Click or tap the input field of the **Threshold** to set the threshold with the pop-up numeric keypad. You can also use the corresponding multipurpose knob to set the value.
- In **CS Polarity**, select "**Positive**" or "**Negative**".

### Endian

Click or tap the drop-down button of **Endian** to select the desired endian.

- **LSB:** indicates Least Significant Bit transmission sequence, i.e. the lowest bit of the data is transmitted first.
- **MSB:** indicates Most Significant Bit transmission sequence, i.e. the highest bit of the data is transmitted first.

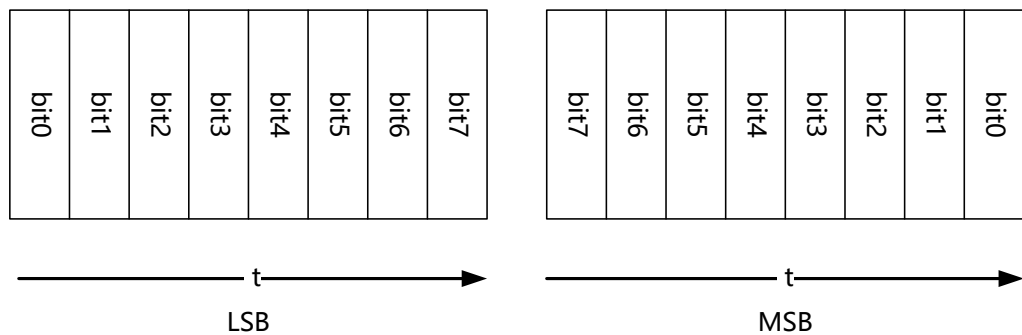

### Polarity

In **Polarity**, select "**Positive**" or "**Negative**".

### Width Setting

Click or tap the input field of **Width**, and then use the pop-up numeric keypad to set the bits of each frame of data. You can also use the corresponding multipurpose knob to set the value. The setting range is from 4 to 32. By default, it is 8.

## 14.4.3 Display-related Settings

In **Decode** menu, set the following display-related parameters.

### Set the Display Format

Click or tap the drop-down button of **Format** to select the display format of the bus data. The available options include "**Hex**", "**Dec**", "**Bin**", and "**ASCII**".



## Set the Label Display

Click or tap the **Label** on/off switch to enable or disable the label display of the decoding bus. When enabled, the bus label will be displayed at the upper-left side of the bus (when the bus display is enabled). The label shows the current bus type.

## 14.4.4 Event Table

### Open or Close the Event Table

Click or tap the **Event Table** on/off switch to enable or disable the display of the event table. When enabled, the event table is displayed as shown in the figure below.

You can also click or tap the icon  at the upper-right corner of the table to close the event table.



Figure 14.13 SPI Decoding Event Table



### TIP

- When you adjust the horizontal time base, the waveform displayed on the screen will also change, and the total number of lines containing the decoding information in the event table will also be changed.
- The displayed decoded data information in the bus is related to the value of the horizontal time base. Reducing the horizontal time base can help you view the detailed information.

### Set the Event Table Format

In the Decode menu, click or tap the drop-down button of **Format** to select the display format of "Data" in the event table. The available options include "Hex", "Dec", "Bin", or "ASCII".

## 14.5 LIN Decoding

The oscilloscope samples the LIN signal, and judges each data point to be logic "1" or logic "0" according to the preset threshold level. The LIN decoding is required to specify the LIN signal protocol version.

In the **Decode** menu, click or tap the drop-down button of **Bus Type** to select **LIN**, then configure the parameters for LIN decoding.

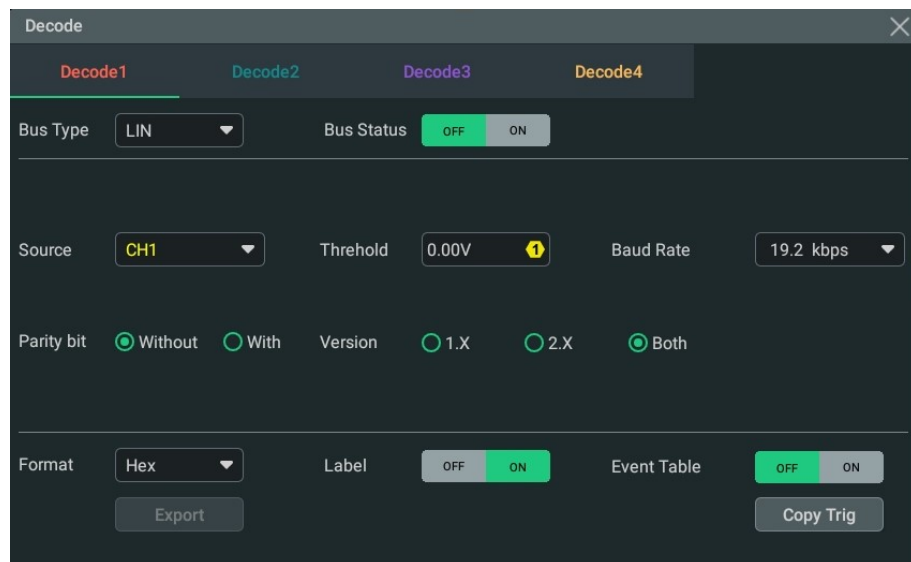

Figure 14.14 LIN Decoding Menu

### Bus Status

Click or tap the **Bus Status** on/off switch to enable or disable the bus decoding.

### Quickly apply trigger settings to decoding

Copy trig indicates applying the trigger settings to the specified decoding setting.

Click or tap **Copy Trig** to apply the trigger settings to the specified decoding setting.

### 14.5.1 Signal Configuration

#### Set the source and the threshold

- Click or tap drop-down button of **Source** to select the desired source. The sources include CH1-CH4.
- Click or tap the input field of **Threshold**, and then use the pop-up numeric keypad to set the threshold of the source channel. You can also use the corresponding multipurpose knob to set the value.

When you modify the threshold of the clock channel, a dotted line displaying the current threshold level is displayed on the screen. It disappears in about 2 s after you stop modifying the threshold.

### Set the signal

- Click or tap the drop-down button of **Baud Rate** to select the baud rate. The available baud rates include 2.4 kbps, 4.8 kbps, 9.6 kbps, 19.2 kbps, and etc.
- In **Parity bit**, click or tap "With" or "Without" to select whether the data contain the parity bit.
- In **Version**, select the protocol version that matches the LIN bus signal. The available versions include "1.X", "2.X", and "Both".

## 14.5.2 Display-related Settings

In **Decode** menu, set the following display-related parameters.

### Set the Display Format

Click or tap the drop-down button of **Format** to select the display format of the bus data. The available options include "Hex", "Dec", "Bin", and "ASCII".

### Set the Label Display

Click or tap the **Label** on/off switch to enable or disable the label display of the decoding bus. When enabled, the bus label will be displayed at the upper-left side of the bus (when the bus display is enabled). The label shows the current bus type.

## 14.5.3 Event Table

### Open or Close the Event Table

Click or tap the **Event Table** on/off switch to enable or disable the display of the event table. When enabled, the event table is displayed as shown in the figure below.

You can also click or tap the icon  at the upper-right corner of the table to close the event table.

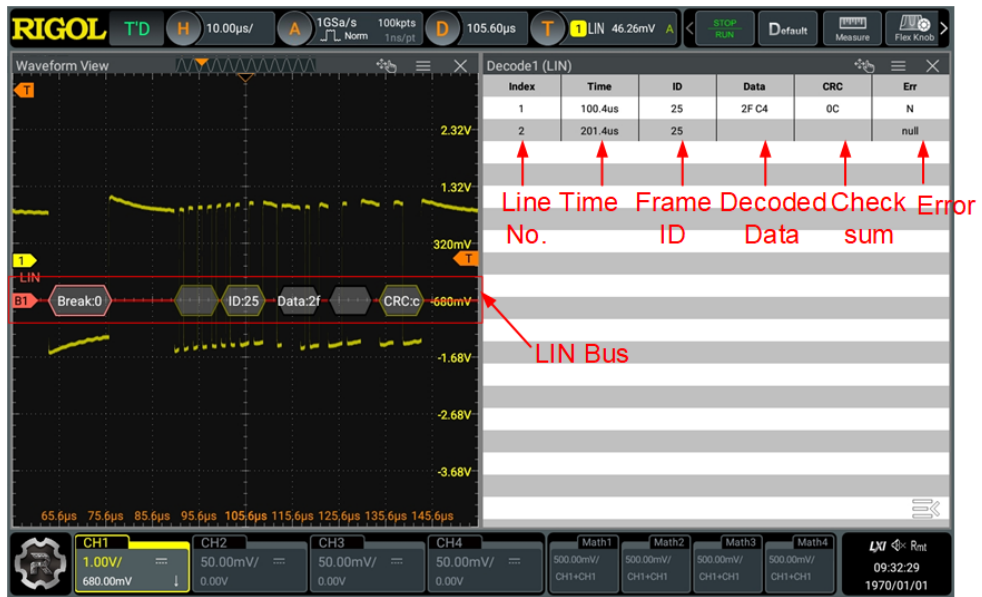

Figure 14.15 LIN Decoding Event Table



**TIP**

- When you adjust the horizontal time base, the waveform displayed on the screen will also change, and the total number of lines containing the decoding information in the event table will also be changed.
- The displayed decoded data information in the bus is related to the value of the horizontal time base. Reducing the horizontal time base can help you view the detailed information.

**Set the Event Table Format**

In the Decode menu, click or tap the drop-down button of **Format** to select the display format of "Data" in the event table. The available options include "**Hex**", "**Dec**", "**Bin**", or "**ASCII**".

**Interpret the Decoded LIN Data**

- Break (Sync Break): expressed in Hex, identified as "Break:".
- SYNC (Sync): expressed in Hex, identified as "SYNC:".
- ID (Frame ID): expressed in Hex, identified as "ID:".
- Data (Data): Its display format is the same as that of the bus data (Hex, Dec, Bin, or ASCII), identified as "Data:".
- CRC (Cyclic Redundancy Check): expressed in Hex, identified as "CRC:". When errors occur, it is displayed as a red patch for the checksum error.
- Wakeup (wake up symbol): identified as "Wakeup:".

## 14.6 CAN Decoding (Optional)

The oscilloscope samples the CAN signal at the specified sample position, and judges each data point to be logic "1" or logic "0" according to the preset threshold level. You need to specify the CAN signal type and sample position.

In the **Decode** menu, click or tap the drop-down button of **Bus Type** to select **CAN**, then configure the parameters for CAN decoding.

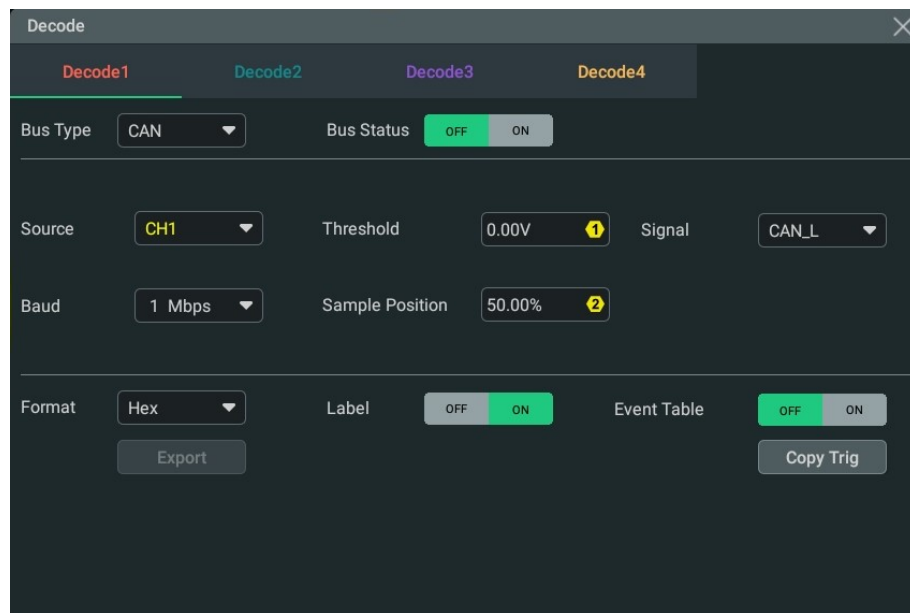

Figure 14.16 CAN Decoding Menu

### Bus Status

Click or tap the **Bus Status** on/off switch to enable or disable the bus decoding.

### Quickly apply trigger settings to decoding

Copy trig indicates applying the trigger settings to the specified decoding setting.

Click or tap **Copy Trig** to apply the trigger settings to the specified decoding setting.

### 14.6.1 Signal Configuration

#### Set the source and the threshold

- Click or tap drop-down button of **Source** to select the desired source. The sources include CH1-CH4.
- Click or tap the input field of **Threshold**, and then use the pop-up numeric keypad to set the threshold of the source channel. You can also use the corresponding multipurpose knob to set the value.

When you modify the threshold of the clock channel, a dotted line displaying the current threshold level is displayed on the screen. It disappears in about 2 s after you stop modifying the threshold.

### Select the Signal Type

Click or tap the drop-down button of **Signal** to select a signal type that matches the CAN bus signal. The available signal types include CAN\_H, CAN\_L, Rx, Tx, and Diff.

- **CAN\_H**: indicates the actual CAN\_H bus signal.
- **CAN\_L**: indicates the actual CAN\_L bus signal.
- **Rx**: indicates the Receive signal from the CAN bus transceiver.
- **Tx**: indicates the Transmit signal from the CAN bus transceiver.
- **DIFF**: The CAN differential bus signals connected to an analog source channel by using a differential probe. Connect the probe's positive lead to the CAN\_H bus signal and connect the negative lead to the CAN\_L bus signal.

### Specify the Standard Signal Rate

Click or tap the drop-down button of **Baud** to select the preset baud rate. The available baud rates include 10.0 kbps, 19.2 kbps, 20.0 kbps, 33.3 kbps and etc.

### Sample Position

Sample position is a point within a bit's time. The oscilloscope samples the bit level at this point. The sample position is represented by the proportion of "the time from the start of the bit to the sample point" to the "bit time", as shown in the figure below.

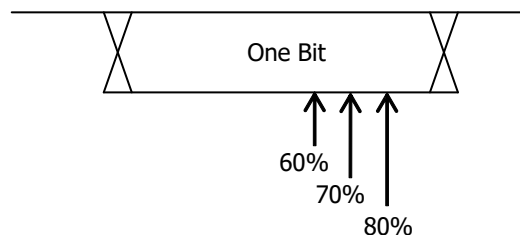

Figure 14.17 Sample Position

Click or tap the input field of **Sample Position** to set it by using the pop-up numeric keypad. You can also use the corresponding multipurpose knob to set the value. The settable range is from 10% to 90%.

## 14.6.2 Display-related Settings

In **Decode** menu, set the following display-related parameters.

## Set the Display Format

Click or tap the drop-down button of **Format** to select the display format of the bus data. The available options include "Hex", "Dec", "Bin", and "ASCII".

## Set the Label Display

Click or tap the **Label** on/off switch to enable or disable the label display of the decoding bus. When enabled, the bus label will be displayed at the upper-left side of the bus (when the bus display is enabled). The label shows the current bus type.

## 14.6.3 Event Table

### Open or Close the Event Table

Click or tap the **Event Table** on/off switch to enable or disable the display of the event table. When enabled, the event table is displayed as shown in the figure below.

You can also click or tap the icon  at the upper-right corner of the table to close the event table.



Figure 14.18 CAN Decoding Event Table



### TIP

- When you adjust the horizontal time base, the waveform displayed on the screen will also change, and the total number of lines containing the decoding information in the event table will also be changed.
- The displayed decoded data information in the bus is related to the value of the horizontal time base. Reducing the horizontal time base can help you view the detailed information.

### Set the Event Table Format

In the Decode menu, click or tap the drop-down button of **Format** to select the display format of "Data" in the event table. The available options include "**Hex**", "**Dec**", "**Bin**", or "**ASCII**".

### Interpret the Decoded CAN Data

- Frame ID: expressed in Hex, identified as "ID:".
- DLC (Data Length Code): expressed in Hex, identified as "DLC:".
- Data: Its display format is the same as that of the bus data (Hex, Dec, Bin, or ASCII), identified as "Data:".
- CRC (Cyclic Redundancy Check): expressed in Hex, identified as "CRC:".
- ACK (Acknowledgement): identified as "ACK". When errors (ACK is detected to be 1) occur, displayed as a red patch.
- R (remote frame): identified as "R:".
- Stuff (Bit filling error): identified as "Stuff".



## 15 Multi-pane Windowing

This series oscilloscope supports multi-pane windowing. You can add multiple windows and result display windows for display and view.

Click or tap  > **Windows** to enter the "Add Window" menu. You can also click or tap the **Windows** button in the toolbar at the top of the screen to enter the menu, as shown in the figure below.

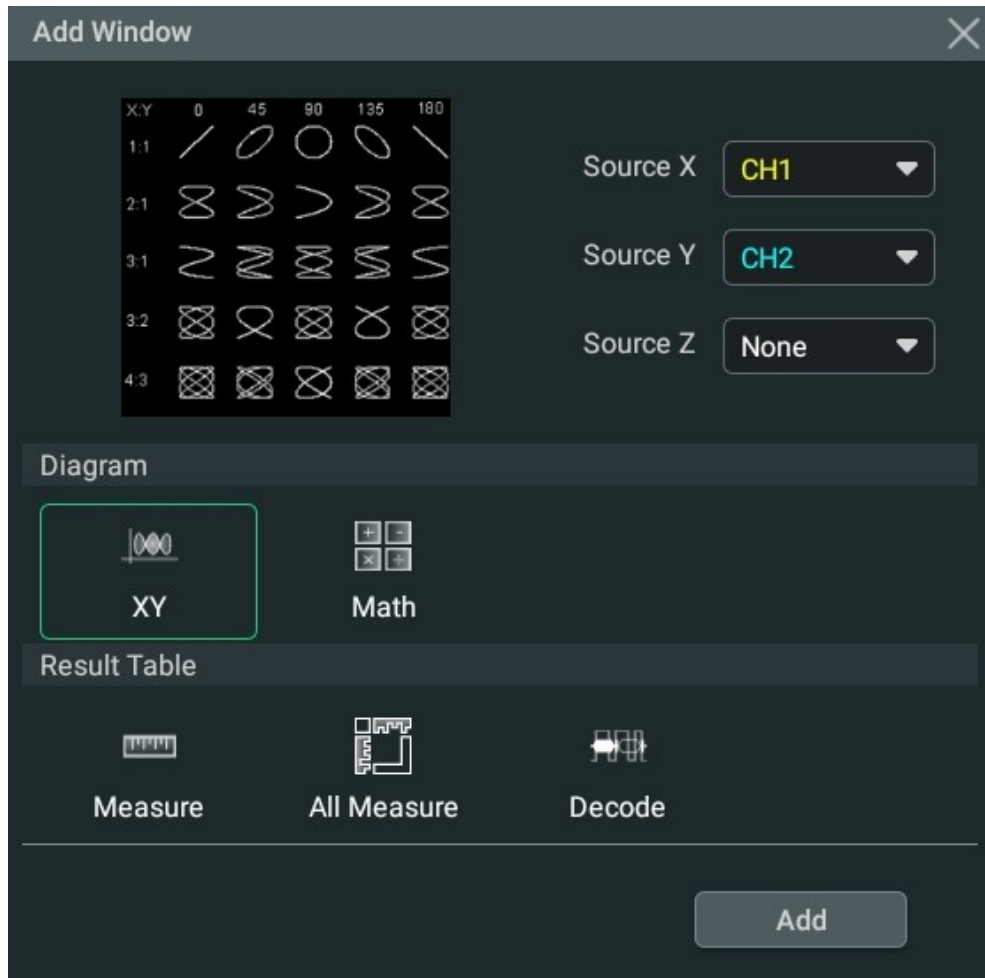

Figure 15.1 "Add Window" Menu

### Add Diagram Windows

1. First, select "XY" or "Math" in **Diagram**. When a diagram is selected, its preview and parameter setting items can be displayed at the upper part of the "Add Window" menu.
2. You can set the corresponding parameters according to your needs. For details, refer to descriptions of relevant chapters.
3. Click or tap **Add** and then the selected diagram is displayed on the screen.



### Add Result Table Window

Click or tap "**Measure**", "**All Measure**", or "**Decode**" in **Result Table**, then click or tap **Add**. The corresponding measurement results will be displayed on the screen.

## 16 Waveform Recording and Playing

Waveform recording/playing function can play the recorded waveforms of the analog input channels (CH1-CH4), enabling you to analyze the waveforms better.

You can enter the "Record" menu in the following ways.

- Click or tap the function navigation icon  and then select **Record** to enter the "Record" menu.
- Click or tap **Record** in the toolbar to enter the "Record" menu.
- Press the front-panel  key and select **Record** in the pop-up "Analyse" menu to enter the "Record" menu.

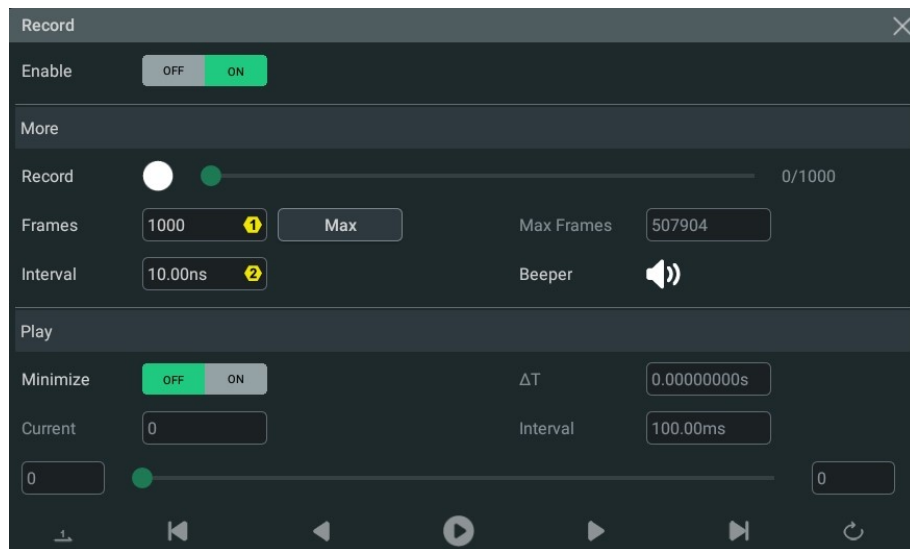

Figure 16.1 "Record" Menu









### TIP

When the acquisition mode is set to *UltraAcquire*, the waveform recording/playing function is not available. You can view waveform segments using *To navigate segments*.

## 16.1 Common Settings

### Waveform Recording



Click or tap the **Record** on/off switch to enable or disable the waveform recording function. Before recording the waveform, you can refer to descriptions in *Record Options* to set the waveform recording parameters.

- Click or tap the **Record** button  to start recording the waveforms. Then the record icon turns into  from .
- The data besides the record progress bar indicate the current frame/total frames. During recording, the current recording information is displayed on the screen in real time with the current frames constantly changing.
- After the recording is completed,  turns into  and recording stops automatically.
- During recording, you can also click or tap  to suspend the recording manually.



Currently Recorded Frames    Total Frames

### Waveform Playing

Click or tap the play icon  in **Play** to start playing the recorded waveforms. Then the play icon turns into  from . For details about playing, refer to descriptions in *Play Options*. During waveform playing, the value in **Current** changes dynamically.

During playing, you can also click or tap the icon  again to suspend playing manually.  $\Delta T$  indicates the time interval between the current frame and the first frame during the recording process.

## 16.2 Record Options

During the waveform recording, the oscilloscope records the waveforms of the currently enabled channel at a specified interval until you manually stops the recording operation or the number of recorded frames has reached the limit.

Before recording the waveforms, set the following parameters.

### 1. Interval

The recording interval indicates the time interval between the frames during the recording process.

Click or tap the **Interval** input field and use the pop-up numeric keypad to set the time interval between frames. You can also use the front-panel multipurpose knob to set the value. The available range is from 10 ns to 10 s.

### 2. Frames

The recording frames refer to the number of frames that can be recorded actually. After starting the recording operation, the oscilloscope stops the recording

operation automatically when the number of recorded frames reaches the set value.

Click or tap the **Frames** input field to set the number of waveform frames to be recorded currently. You can also use the front-panel multipurpose knob to set the value. The range available is from 1 to the maximum number of frames that can be recorded currently.

### 3. Max Frames

The input field of **Max Frames** displays the maximum number of frames that can be recorded currently. Click or tap **Max** and the frames will be automatically set to the maximum value.

As the waveform memory is fixed, the more points in each frame, the fewer waveform frames that can be recorded. Therefore, the maximum number of recorded frames is related to the currently selected "memory depth" (refer to *Memory Depth*). The current memory depth refers to the number of waveform points per frame.  $\text{Memory Depth} = \text{Sample Rate} \times \text{Horizontal Time Base} \times \text{Number of Grids in the Horizontal Direction}$ . Therefore, the Max. value of waveform recording is also related to the "Sample Rate" and "Horizontal Time Base".

### 4. Beeper



: the beeper sounds at the end of recording.



: the beeper does not sound at the end of recording.

## 16.3 Play Options

Waveform playing function can play back the waveforms currently recorded. In **Play**, click or tap the **Minimize** on/off switch to select whether to minimize the menu. When **ON** is selected, the window is minimized, making the display more simplified, easy for observation and operation. The minimized menu is as shown in the figure below.

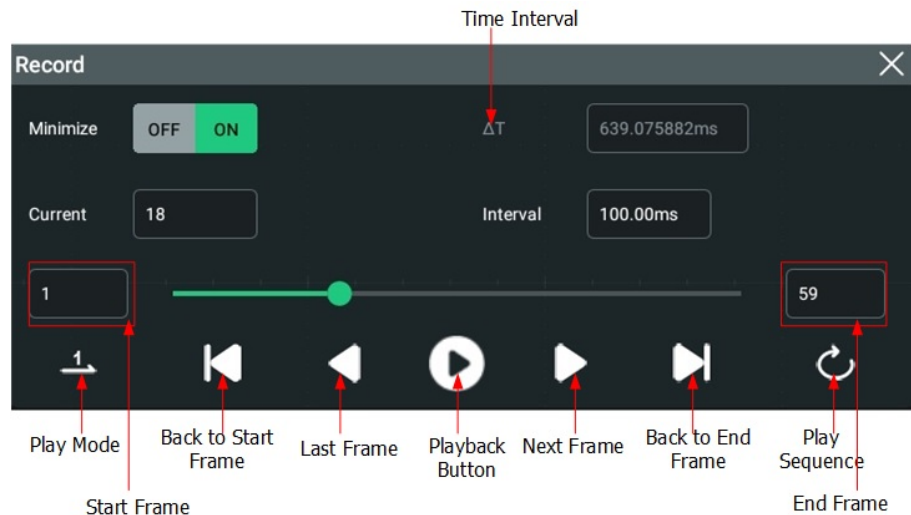



**Figure 16.2 Minimized "Play" Menu**

Before playing the waveforms, set the following parameters.



### 1. Play Mode

You can play the waveforms in single mode () or cycle mode (.

- : plays from the start frame to the end frame, and then stops automatically.
- : plays from the start frame to the end frame, then such playback operation is repeated until you stop it manually.

### 2. Play Sequence

You can play back the waveforms clockwise () or counterclockwise (.

- : plays from the start frame to the end frame.
- : plays from the end frame to the start frame.

### 3. Interval

The playback interval indicates the time interval between the frames during the playing process.

Click or tap the **Interval** input field, then use the pop-up numeric keypad to set the time interval between frames. You can also use the corresponding multipurpose knob to set the value. The available range is from 1 ms to 10 s.

### 4. Start Frame

Click or tap the "Start Frame" input field in *Figure 16.2* to set the start frame for playing back the waveforms. You can also use the corresponding multipurpose knob to set the value. The default is 1, and the maximum value is the maximum number of frames recorded.

#### 5. End Frame

Click or tap the "End Frame" input field in *Figure 16.2* to set the end frame for playing back the waveforms. You can also use the corresponding multipurpose knob to set the value. The default is the number of frames of the recorded waveforms.

#### 6. Current Frame

When the playing is stopped, click or tap the **Current** input field in *Figure 16.2* to set the currently displayed frame with the pop-up numeric keypad. You can also use the corresponding numeric keypad to set the value. The maximum allowed is the number of recorded frames.

# 17 Search and Navigation

The Search function allows you to quickly find and mark the event of interest and then go to the specified event in the marktable by navigating search events. The search types include edge and pulse.

The Navigation function allows you to quickly view and navigate waveforms. You can navigate time, search events, and segments.

## 17.1 Search

This function allows you to search for the specified edge and pulse width trigger. Found search events are marked with small inverted triangles (▼) at the top of the graticule. You can click or tap  and select **Search** to access the Search menu, as is shown in the figure below.

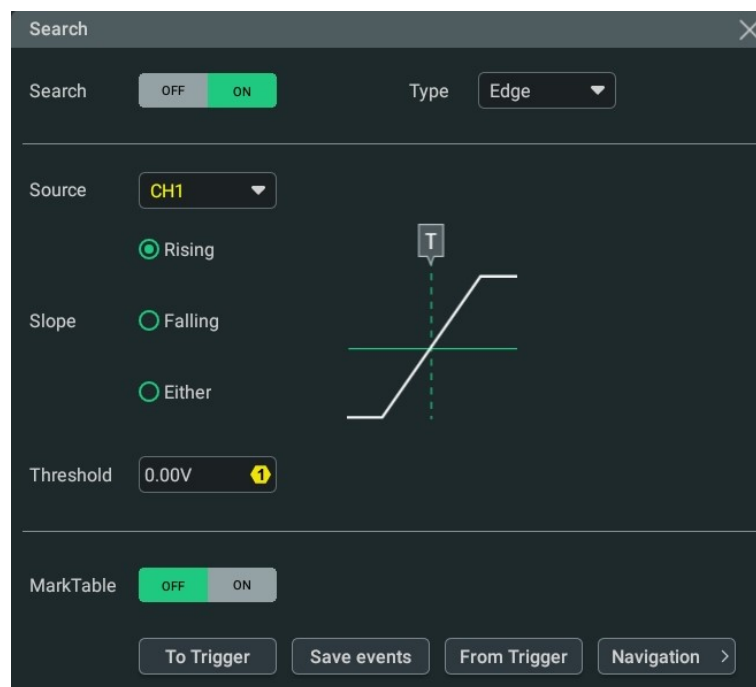

Figure 17.1 Search Menu

### 1. Search On/Off

Click or tap **Search** on /off switch to enable or disable the search function.



#### TIP

Enabling the search function automatically turns on the *Zoom Mode (Delayed Sweep)*.

### 2. To Set up searches



Click or tap the **Type** drop-down button to select "Edge" or "Pulse". Click or tap the **Source** drop-down button to select the source.

- **Edge Searches:** After setting the search type to "Edge", you can select the slope type. For details, please refer to *Edge Trigger*. You can click or tap the **Threshold** input field to set the threshold with the pop-up numeric keypad or use the corresponding multipurpose knob to set the value.
- **Pulse Width Searches:** After setting the search type to "Pulse", you can set the trigger condition. For details, please refer to *Pulse Width Trigger*. You can click or tap the **Threshold** input field to set the threshold with the pop-up numeric keypad or use the corresponding multipurpose knob to set the value.

### 3. To copy search setups

- **Copy to Trigger**

Click or tap **To Trigger** to copy the setup for the selected search type to the same trigger type. For example, if the current search type is "Edge", clicking or tapping **To Trigger** copies the search settings to the "*Edge Trigger*" settings.

- **Copy from Trigger**



Click or tap **From Trigger** to copy the trigger setup for the selected search type to the search setup. For example, if the current trigger type is "*Edge Trigger*", clicking or tapping **From Trigger** copies the trigger settings to the "Edge" search setup.

#### NOTE

To use the "Copy from Trigger" function, please first set the search type and then copy the specified trigger setup in the Trigger menu.

### 4. Marktable On/Off

Click or tap the **MarkTable** on /off switch to turn on or off the marktable display. When "ON" is selected, a table is displayed in the interface as shown in the figure below. The table lists all events of the current waveform in the Waveform View. Zooming on or adjusting the waveform causes the events in the table to change. You can perform the following operations on the table:

- When acquisitions are stopped (STOP mode), click or tap any row of the table to select the specified event. The inverted triangle mark of the selected event turns red like .
- Click or tap  at the upper-right side of the table to open the search menu.

- Select the gray title bar of the table to drag the table and move the table window.
- Click or tap  at the upper-right side of the table to close the search menu.

Search			
Index	Time	EventCount	Info
1	-50us	1	Rising edge
2	-49.59us	1	Rising edge
3	-48.79us	1	Rising edge
4	-47.99us	1	Rising edge
5	-47.19us	1	Rising edge
6	-46.39us	1	Rising edge
7	-45.59us	1	Rising edge
8	-44.79us	1	Rising edge
9	-43.99us	1	Rising edge
10	-43.19us	1	Rising edge

Figure 17.2 MarkTable Display

## 5. Navigation

Click or tap **Navigation** to access the navigation menu. You can use the "Search Event" mode in *Navigation* to navigate through the search events.

## 6. To Save search events

You can save the event data to the instrument's internal memory or an external USB storage device in format of "\*.csv".

Click or tap **Save events** to access the "Save" menu. For details, please refer to *To Save a File*.



### NOTE

This series only supports the flash memory USB storage device of FAT32 format.

## 17.2 Navigation

The Navigation function allows you to navigate time, search events, and segments. You can access the **Navigation** menu in the following ways.

- Press the front-panel  key to access the menu.
- Click or tap **Navigate** in the toolbar at the upper-right of the interface.

- In the "Search" menu, click or tap **Navigation** to access the menu.

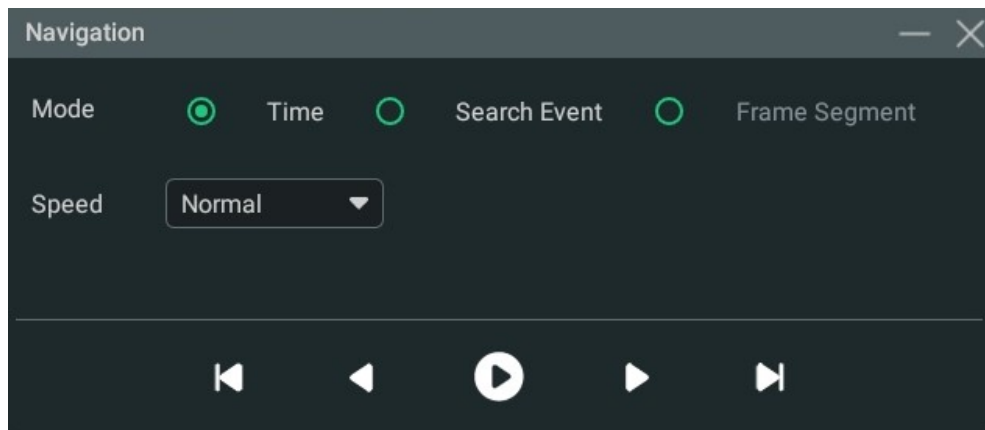

**Figure 17.3 Navigation Menu**

The normal Navigation menu is as shown in the figure above. You can click or tap  to minimize the menu (see the figure below) for a simplified interface.

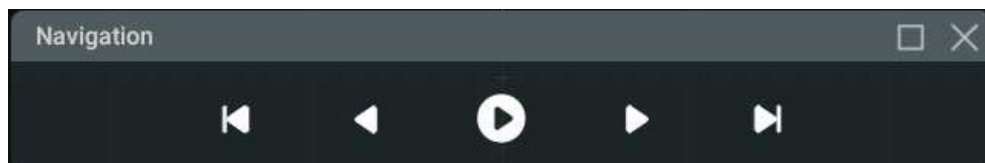







**Figure 17.4 Simplified Navigation Menu**



#### **TIP**





The navigation function is available only when the oscilloscope is in "STOP" state (acquisition stopped).

#### **To navigate time**

It is available only when in "YT" time mode. When "Time" is selected, click or tap  in "Navigation" menu or press the front-panel  key to start/stop playback. During playback, you can click or tap  to play backward or  to play forward. The playback automatically stops when it reaches the left or right edges. When it stops, clicking or tapping  /  moves the waveform. Click or tap the **Speed** drop-down button to select the speed level.

#### **To navigate search events**

After searching events using the Search function, you can select the "Search Event" mode in Navigation menu to navigate to specific events in the marktable. After "Search Event" is selected, click or tap **Search** to open the "Search" menu and set the



search condition. For search setup, please refer to *Search*. Click or tap the **Type** drop-down button to select "Edge" or "Pulse". Click or tap  to go to the previous search event or  to go to the next search event. Click or tap  to go to the first event or  to go to the last event.







### To navigate segments

This mode is available only in UltraAcquire acquisition mode. When UltraAcquire is enabled, the **Mode** is automatically set to "Frame Segment" which cannot be modified.

- In this mode, you can click or tap the **Display mode** drop-down button to set the display mode of segments. For details, please refer to *UltraAcquire*.
- Click or tap **Start Frame** and **End Frame** input fields to set the start and end frames which define the segment range to navigate through. You can also use the corresponding multipurpose knob to set the start/end frame. After you click or tap the play/stop key, it plays from the "Start Frame" and the number of frames that can display on each screen page is (End Frame-Start Frame+1).

For example, if you set the start frame to 3 and the end frame to 9, it will play from the 3rd frame and displays 7 frames at a page.

- Click or tap  in "Navigation" menu or press the front-panel  key to start/stop playing through the frames between the **Start Frame** and **End Frame**.

During playout, you can click or tap  to play backward or  to play forward. The playout automatically stops when it reaches the left or right edges. When it stops, you can click or tap  /  to go forward or backward. You can also click or tap  to go to the first page or  to go to the last page. The current page/total pages is indicated in **Current Page**.

### TIP

During segment playing, you are not allowed to change the start/end frame.



## 18 Display Control

In the **Display** setting menu, you can set the type, persistence time, waveform intensity, grid type, grid brightness, and etc. Click or tap the function navigation icon



at the lower-left corner of the screen, and then select **Display** to enter the

"Display" menu. You can also click or tap the icon at the upper-right of the Waveform View to enter the "Display" menu.

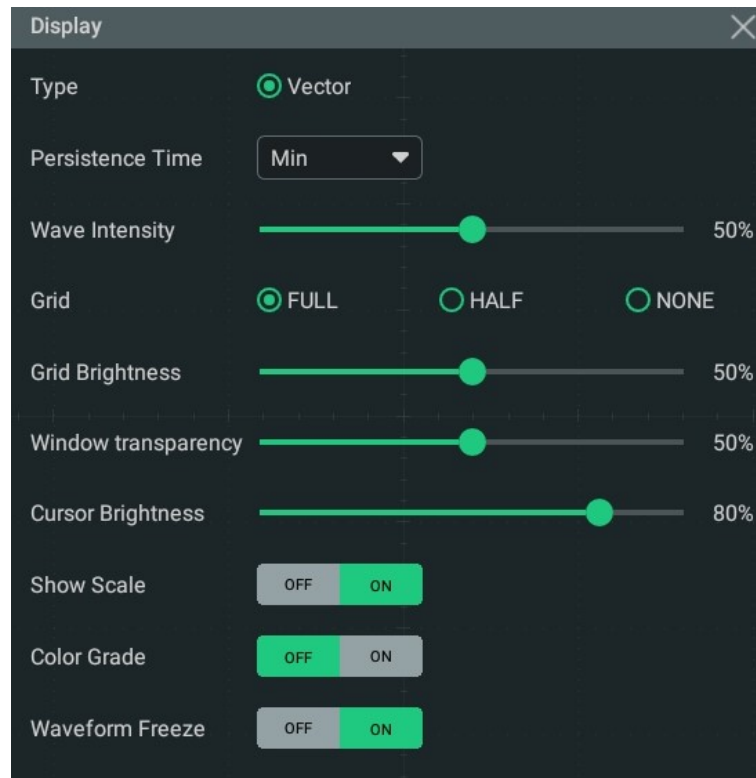

Figure 18.1 Display Setting Menu

### 18.1 Display Type

This series oscilloscope provides the "Victor" display mode in which the sample points are connected by lines and displayed. In most cases, this mode can provide the most vivid waveform for you to view the steep edge of the waveform (such as square waveform).

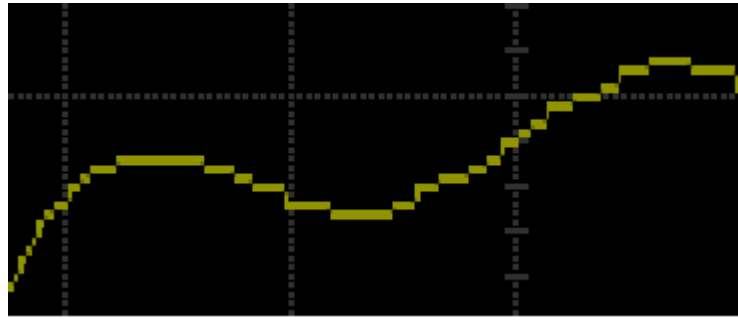

Figure 18.2 Vector Display

## 18.2 Persistence Time

In the **Display** setting menu, click or tap the drop-down button of **Persistence Time** to select the persistence time. The available values are Min, specific values (100 ms, 200 ms, 500 ms, 1 s, 2 s, 5 s, 10 s), and Infinite.

In the following part, a frequency sweep signal of the sine waveform is used to show the waveform effects in different persistence times.

- **Min**

Enables you to view waveform changing in high refresh rate.

- **Specific Values**

Enables you to view glitches that change relatively slowly or glitches with lower occurrence probability. The persistence time can be set to 100 ms, 200 ms, 500 ms, 1 s, 2 s, 5 s, or 10 s.

- **Infinite**

In this mode, the oscilloscope displays the waveform newly acquired without clearing the waveforms acquired formerly. The waveforms acquired formerly will be displayed in relatively low-brightness color and the newly acquired waveforms will be displayed in normal brightness and color. Infinite persistence can be used to measure noise and jitter and to capture incidental events.

## 18.3 Waveform Intensity

In **Display** menu, drag the slide bar of **Wave Intensity** to set the brightness of waveforms. The default is 50%, and the range available is from 1% to 100%.

## 18.4 To Set the Screen Grid

In the **Display** menu, select "FULL", "HALF", or "NONE" in **Grid**.

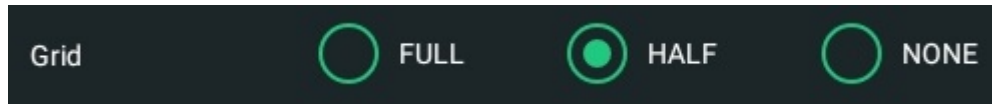

- **FULL:** turns the background grid and coordinate on.
- **HALF:** turns the background grid off.
- **NONE:** turns the background grid and coordinate off.

## 18.5 Display Settings

### Grid Brightness

In the **Display** setting menu, drag the slider of **Grid Brightness** to set the grid brightness. The default is 50%, and the range available is from 1% to 100%.

### Window Transparency

In the **Display** setting menu, drag the slider of **Window Transparency** to set the window transparency. The default is 50%, and the range available is from 0% to 100%.

### Cursor Brightness

In the **Display** setting menu, drag the slider of **Cursor Brightness** to set the cursor brightness. The default is 80%, and the range available is from 0% to 100%.

## 18.6 Show Scale

In the **Display** setting menu, click or tap the **Show Scale** on/off switch to enable or disable scale display on the screen. By default, it is ON.

## 18.7 Color Grade

In the **Display** setting menu, click or tap the **Color Grade** on/off switch to enable or disable the color grade display. By default, it is OFF.

When it is enabled, different colors are displayed on the screen to indicate the times of data acquisition or acquisition probability.

## 18.8 Waveform Freeze

In the **Display** setting menu, click or tap the **Waveform Freeze** on/off switch to enable or disable the waveform freeze function. By default, it is ON.

When the function is enabled, the oscilloscope displays the waveform after multiple sampling and superposition when sampling is stopped. You can click or tap the **STOP/RUN** button at the upper-right side of the screen or press the front-panel



key to stop sampling. If this function is disabled, the last triggered waveform is displayed.



## 19 Store and Load

---

You can save the current setups, waveforms, screen image, and parameters of the oscilloscope to the internal memory or external USB storage device (such as USB storage device) in various formats and recall the stored setups or waveforms when necessary. You can also load the upgrade software to the system and perform the upgrade operation for the instrument.

You can also copy, delete, or rename the specified type of file from the internal memory or external USB storage device via the disk management menu.

This oscilloscope provides two USB HOST interfaces on the front panel, which can all be connected to the USB storage device for external storage. The USB storage devices connected are marked as "Removable USB Disk (D)" and "Removable USB Disk (E)".

### TIP



This oscilloscope only supports the flash memory USB storage device of FAT32 format.

### 19.1 To Enter the Storage Menu

---

You can enter the storage setting menu in the following ways.

- Click or tap the function navigation icon  at the lower-left corner corner of the screen, and then select **Storage** to enter the storage setting menu.
- Click or tap the **Storage** button in the toolbar to enter the storage setting menu.

In the **Storage** setting menu, there are three sub-menus (Save, Load, and Upgrade) for you to choose. Select the specified sub-menu and configure the corresponding parameters.

### 19.2 To Save a File

---

In the **Storage** menu, click or tap the **Save** tab to enter the save setting menu. In this menu, you can save the image, waveform, or setup files.

#### 19.2.1 Save Image

---

In the **Storage** menu, click or tap the **Save** tab to enter the save operation menu. In this menu, click or tap the drop-down button of **Choose** to select "**Save Image**" to enter the "Save Image" setting menu. Set the relevant parameters and save the image to the internal or external memory.

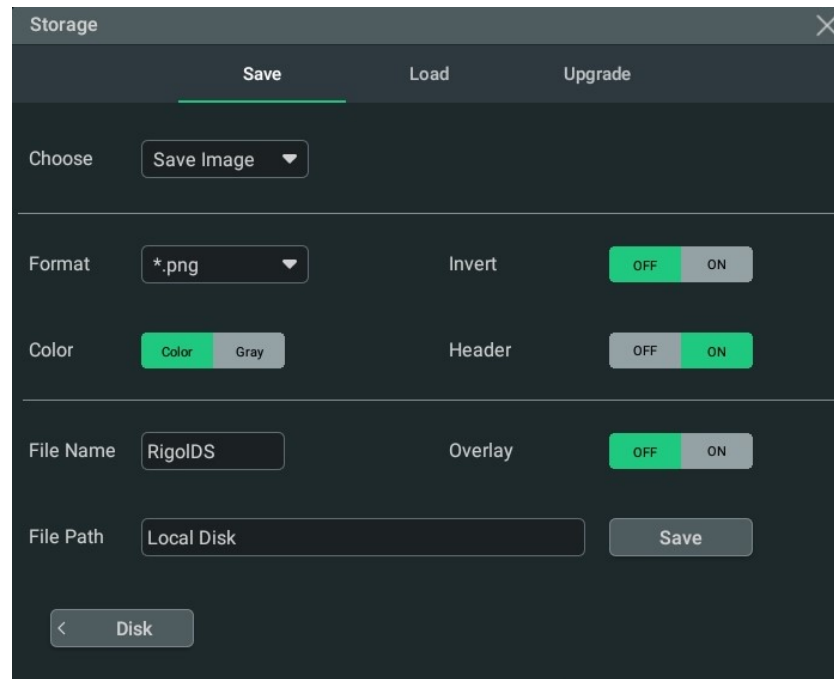

Figure 19.1 Image Saving Setting Menu

#### Set the image format

- **Format:**

Click or tap the drop-down button of **Format** to select **"\*.png"**, **"\*.bmp"**, or **"\*.jpg"**. Then the screen image will be saved to the internal or external memory in ".png", ".bmp", or ".jpg" format.

- **Invert:**

Click or tap the **Invert** on/off switch to turn on/off inverting image colors.

- **Color:**

Click or tap the **Color** toggle button to select **"Color"** or **"Gray"** images.

- **Header:**

Click or tap the **Header** on/off switch to enable or disable the display of the header. If you select "ON", the instrument model and the image creation date will be displayed in the header of the image after you save the image file.

#### Set the file saving parameters

- **Set the filename**

Click or tap the input field of **File Name** to input the file name to be saved with the pop-up virtual keypad.

- **Set the file path**

Click or tap the input field of **File Path**, then the disk management interface is displayed. You can click or tap the saved file to view the saved image file. For detailed operations, refer to descriptions in *Disk Management*.

When a USB device is not connected, the default file path is the "Local Disk"; when a USB device is detected, the path is automatically set to "D:".

- **Overlay**

Click or tap the **Overlay** on/off switch to enable or disable the overwriting function. When this function is enabled, the existing file in the specified file path will be overwritten by the newly saved file that has the same filename as the existing one.

Click or tap **Save**, the current screen image is saved based on the settings and the storage menu is disabled.



**TIP**

When the quick action function is set to "Save Image" or "Save Group" with "Save Image" selected, you can press the front-panel  key to save the image.

## 19.2.2 Save Wave

In the **Storage** menu, click or tap the **Save** tab to enter the save operation menu. In this menu, click or tap the drop-down button of **Choose** to select "**Save Wave**" to enter the "Save Wave" setting menu. The main settings (e.g. channel "On/Off" state, vertical scale, and horizontal time base) and waveform data of all enabled channel will be save to the internal or external memory.

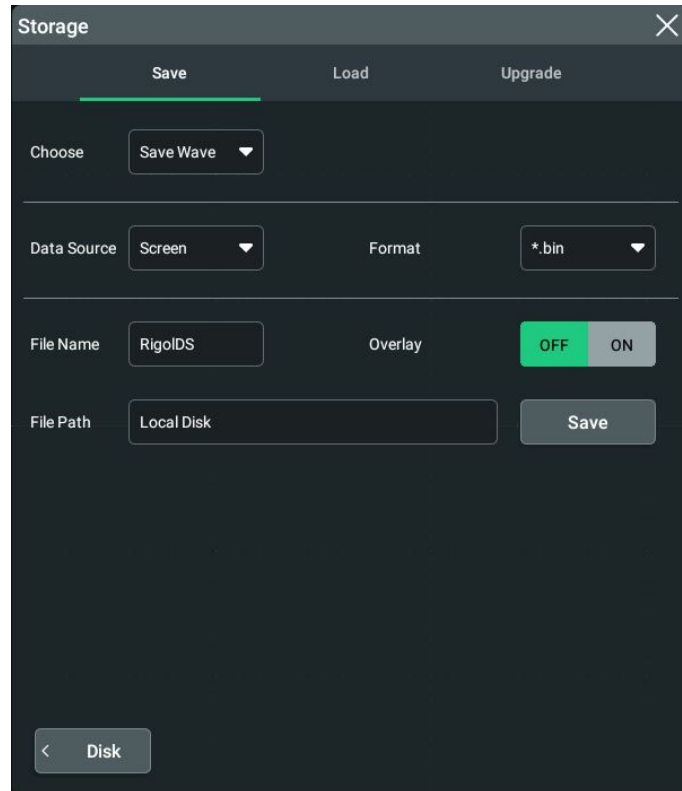

Figure 19.2 Waveform Saving Setting Menu

### Set the Source of the Waveform Data and the Format of the Saved Waveform

- **Data Source**

Click or tap the drop-down button of **Data Source** to select "Screen" or "Memory".

- **Waveform Format**

Click or tap the drop-down button of **Format** to select "\*.bin" or "\*.csv" as the format of the saved waveform.

### Set the file saving parameters

- **Set the filename**

Click or tap the input field of **File Name** to input the file name to be saved with the pop-up virtual keypad.

- **Set the file path**

Click or tap the input field of **File Path**, then the disk management interface is displayed. You can click or tap the saved file to view the saved file. For detailed operations, refer to descriptions in *Disk Management*.

When a USB device is not connected, the default file path is the "Local Disk"; when a USB device is detected, the path is automatically set to "D:".

- **Overlay**

Click or tap the **Overlay** on/off switch to enable or disable the overwriting function. When this function is enabled, the existing file in the specified file path will be overwritten by the newly saved file that has the same filename as the existing one.

Click or tap **Save**, the current waveform file is saved based on the settings and the storage menu is disabled.



**TIP**

When the quick action function is set to "Save Wave" or "Save Group" with "Save Wave"

selected, you can press the front-panel  key to save the waveform.

## 19.2.3 Save Setup

In the **Storage** menu, click or tap the **Save** tab to enter the save operation menu. In this menu, click or tap the drop-down button of **Choose** to select "**Save Setup**" to enter the "Save Setup" setting menu. Save the settings of the oscilloscope to the internal or external memory in "\*.stp" format. When loading, the stored settings can be recalled.

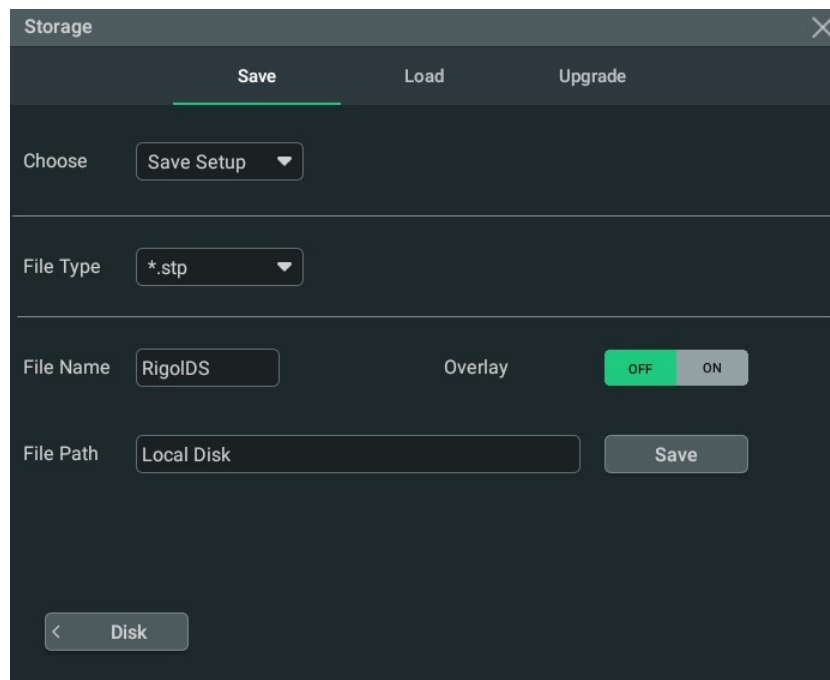

**Figure 19.3 Setup Saving Setting Menu**

### Set the file saving parameters

- **Set the filename**

Click or tap the input field of **File Name** to input the file name to be saved with the pop-up virtual keypad.

- **Set the file path**

Click or tap the input field of **File Path**, then the disk management interface is displayed. Select the target file path and then click or tap **OK**. For detailed operations, refer to descriptions in *Disk Management*.

When a USB device is not connected, the default file path is the "Local Disk"; when a USB device is detected, the path is automatically set to "D:".

- **Overlay**

Click or tap the **Overlay** on/off switch to enable or disable the overwriting function. When this function is enabled, the existing file in the specified file path will be overwritten by the newly saved file that has the same filename as the existing one.

Click or tap **Save**, the current waveform file is saved based on the settings and the storage menu is disabled.

**TIP**

When the quick action function is set to "Save Setup" or "Save Group" with "Save Setup"

selected, you can press the front-panel  key to save the setup.



## 19.2.4 Binary Data Format (.bin)

Binary data format stores waveform data in binary format and provides data headers that describe these data. As data are displayed in binary format, its file size is much more smaller than that in ASCII format. If several channels are enabled, then all the displayed channels will be saved (save the first channel then save the second, and then it goes on like this until all the displayed channels are saved).

**Table 19.1 BIN File Format**

File Header	Waveform Header	Waveform Data Header	Channel Data	Waveform Header	Waveform Data Header	Channel Data
12 Bytes	128 Bytes	12 Bytes	n Bytes	128 Bytes	12 Bytes	n Bytes

In BIN file format, it contains the following channel data:

- CH1 Data
- CH2 Data
- CH3 Data
- CH4 Data

- Math Waveform Data

## Binary Header Format

### 1. File Header

There is only one file header in a binary file. The file header contains the following information.

**Table 19.2 File Header**

Cookie	Two-byte characters, RG, indicating that the file is the <b>RIGOL</b> binary data file format.
Version	Two-byte, indicating the file version.
File Size	A 4-byte integer, indicating the number of bytes in the file. It includes the header.
Number of Waveforms	A 4-byte integer, indicating the number of waveforms that are stored in the file.

### 2. Waveform Header

It is possible to store several waveforms in the file. Each stored waveform has a waveform header. When several channels are stored, each channel can be considered as a separate waveform. The waveform header contains the information about the type of waveform data that are stored following the waveform data header.

**Table 19.3 Waveform Header**

Header Size	A 4-byte integer, indicating the number of bytes in the header.
Waveform Type	<p>A 4-byte integer, indicating the type of the waveform stored in the file.</p> <p>0 = Unknown</p> <p>1 = Normal</p> <p>2 = Peak Detection</p> <p>3 = Average</p> <p>4 = Not Used</p> <p>5 = Not Used</p> <p>6 = Logic</p>

Number of Waveform Buffers	A 4-byte integer, indicating the number of waveform buffers required to read the data.
Number of Points	A 4-byte integer, indicating the number of waveform points in the data.
Count	A 4-byte integer, indicating the number of hits at each time interval during waveform recording when using a certain sample mode (e.g. Average) to create the waveforms. For example, when averaging, a count of 4 indicates that each waveform data point in the waveform recording has been averaged at least 4 times. The default value is 0.
X Display Range	A 4-byte float, indicating the X-axis duration of the waveform that is displayed. For time-domain waveforms, it indicates the duration of time across the display. If the value is zero, then no data has been acquired.
X Display Origin	An 8-byte double, indicating the X-axis value at the left edge of the screen. For time-domain waveforms, it indicates the time at the start of the display. The value is treated as a double precision 64-bit float point number. If the value is zero, then no data has been acquired.
X Increment	An 8-byte double, indicating the duration between data points on the X axis. For time-domain waveforms, it indicates the time between points. If the value is zero, then no data has been acquired.
X Origin	An 8-byte double, indicating the X-axis value of the first data point in the data recording. For time-domain waveforms, it indicates the time of the first point. The value is treated as a double precision 64-bit float point number. If the value is zero, then no data has been acquired.
X Units	<ul style="list-style-type: none"> <li>- A 4-byte integer, indicating the unit of measurement for X values in the acquired data.</li> <li>- 0 = Unknown</li> <li>- 1 = Volts (V)</li> <li>- 2 = Seconds (s)</li> <li>- 3 = Constant</li> <li>- 4 Amps (A)</li> <li>- 5 = dB</li> <li>- 6 = Hz</li> </ul>



Y Units	A 4-byte integer, indicating the unit of measurement for Y values in the acquired data. The possible values are listed above under X Units.
Date	A 16-byte character array, not used
Time	A 16-byte character array, not used
Frame	A 24-byte character array, indicating the model number and serial number of the oscilloscope in the format: MODEL#:SERIAL#.
Waveform Label	A 16-byte character array that contains the label assigned to the waveform.

### 3. Waveform Data Header

A waveform may have multiple data sets. Each waveform data set has a waveform data header. The waveform data header consists of information about the waveform data set. The header is stored before the data set.

**Table 19.4 Waveform Data Header**

Header Size	A 4-byte integer, indicating the number of bytes in the waveform data header.
Buffer Type	<ul style="list-style-type: none"> <li>- A 2-byte integer, indicating the type of the waveform data stored in the file.</li> <li>- 0 = Unknown</li> <li>- 1 = Normal 32-bit float data</li> <li>- 2 = Maximum float data</li> <li>- 3 = Minimum float data</li> <li>- 4 = Not Used</li> <li>- 5 = Not Used</li> <li>- 6 = Digital unsigned 8-bit character data (for digital channels)</li> </ul>
Bytes Per Point	A 2-byte short integer, indicating the number of bytes per data point.
Buffer Size	A 4-byte integer, indicating the size of the buffer required to hold the data points.

## 19.3 Load a File

In the storage setting menu, click or tap the **Load** tab to switch to the load menu. In this menu, you can load the local file to the instrument.

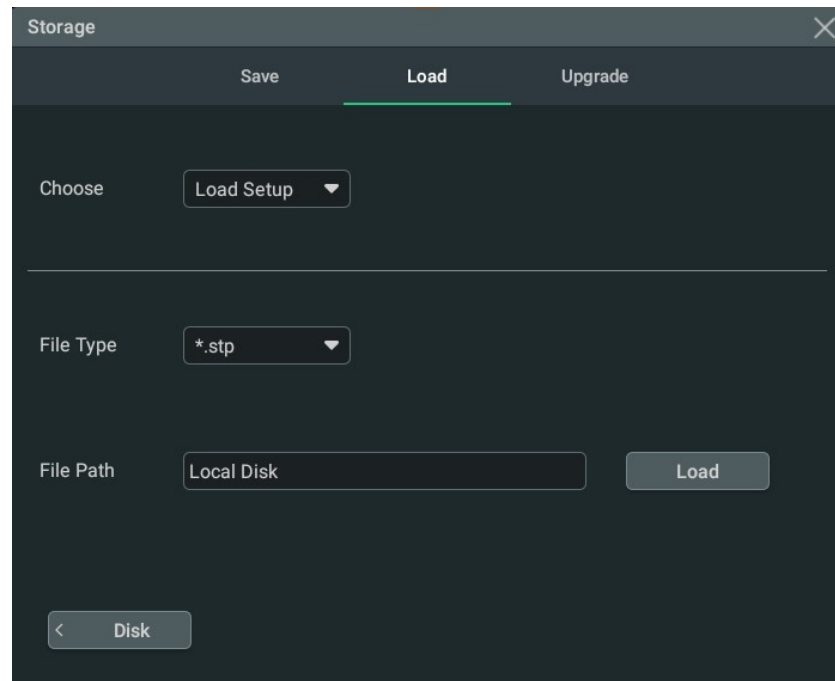

Figure 19.4 Load Setting Menu

### Load Setup

Click or tap the drop-down button of **Choose** to select "Load Setup". Then, click or tap **File Path** to load the setups from the internal memory or the external USB disk. The default file type is "\*.stp", and no other options are available. Select the file to be loaded from the memory. Click or tap **Load** to load the selected file.

## 19.4 System Upgrade

This instrument supports local upgrade and online upgrade.

### Local upgrade

1. In the storage setting menu, click or tap **Upgrade** to enter the local upgrade setting menu.

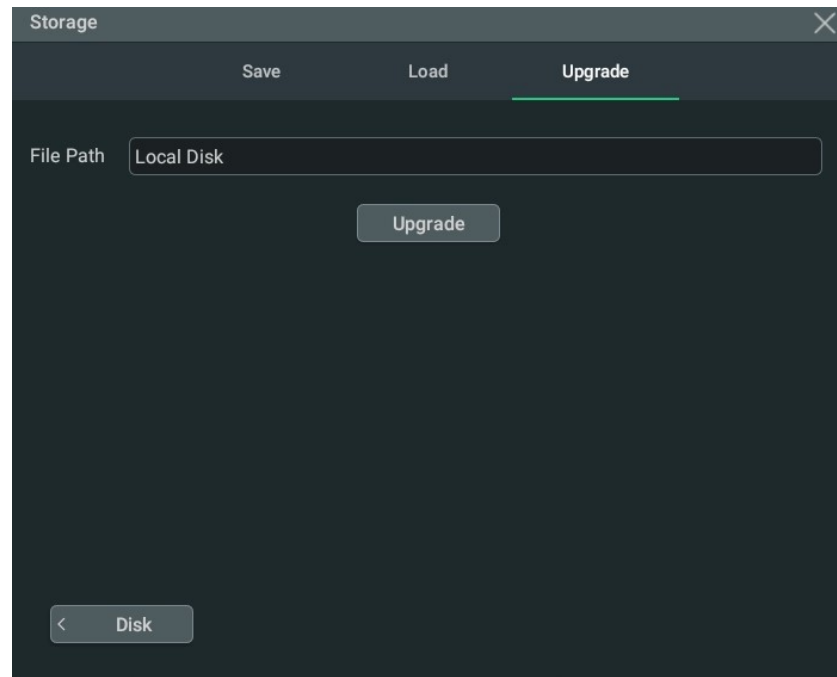

**Figure 19.5 Upgrade Menu**

2. Click or tap the input field of **File Path**, then the disk management interface is displayed. Select the upgrade file. For detailed operations, refer to the descriptions in *Disk Management*.
3. Click or tap **Upgrade** to complete the local upgrade.

### Online upgrade

1. First ensure that the rear-panel LAN interface is connected to the network (if you do not have the access to the Internet, please ask the administrator to open the specified network authority).
2. Click or tap the function navigation icon  at the lower-left corner of the screen to enter the function navigation.
3. Then click or tap **Upgrade** to perform the upgrade operation.

## 19.5 Disk Management

You can enter the storage setting menu in the following ways.

- Click or tap the function navigation icon  at the lower-left corner corner of the screen, and then select **Storage** to enter the storage setting menu.
  - Click or tap the **Storage** button in the toolbar to enter the storage setting menu.
- Then click or tap **Disk** at the lower-left corner of the "Storage" menu to enter the disk management interface, as shown in the figure below.

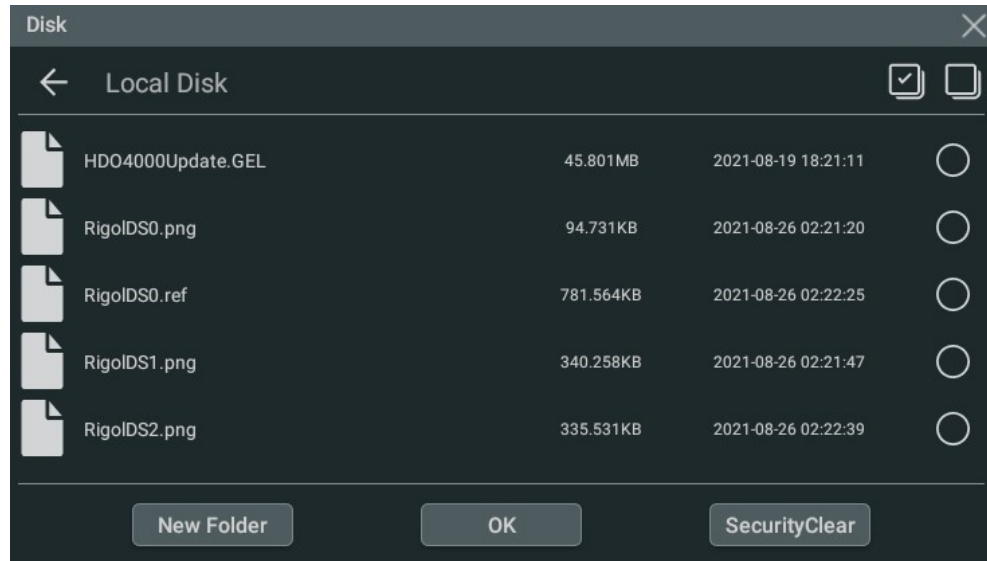

**Figure 19.6 Disk Management Interface**

Execute the following operations through the disk management menu:

### Select a Disk

Before using the external storage device, make sure that a USB storage device (FAT32 format, flash memory) is connected correctly.

By default, the "Local Disk(C)" is selected. If an external storage device is inserted, under the "Disk" menu, two available storage disks can be selected at the upper-left corner of the "Disk" interface: Local Disk (C) and Removable USB Disk (D). If you select an external storage device, for example, if you select "Removable USB Disk (D)", the contents in USB Disk(D) will be displayed.

### Create a Folder

Click or tap **New Folder**, then a folder name input keyboard is displayed.

For how to use the keypad, refer to descriptions in [Parameter Setting Method](#). Click or tap any place on the screen to exit the keyboard.



### Clear the Internal Memory Safely



Click or tap **SecurityClear**, then a prompt message "Execute secure memory wipe?" is displayed. Click or tap **OK** to clear all the files stored in the internal disk. Otherwise, click or tap **Cancel** to cancel security clear operation.

### Select a File

Before operating on the file or folder, first select the desired file or folder.

Click or tap the check box at the right side of the folder, if checked, it is selected, with

an icon  being displayed. Click or tap the check box again or  to deselect it. The check box restores its original state.

This series supports selecting multiple files or folders to operate on. You can also click or tap the icon  at the upper-right corner of the interface to select all the files and folders under the current disk. Click or tap  to cancel the select-all operation.

### Cut, Copy, or Paste a File or a Folder

- **Cut a File to a Specified Folder**

Select a specified file or folder. Click or tap **Cut** to cut the specified file or folder. Then select the destination folder. Then click or tap **Paste** to paste the specified file or folder to the destination folder.

- **Copy a File to a Specified Folder**

Select a specified file or folder. Click or tap **Copy** to copy the specified file or folder. Then select the destination folder. Then click or tap **Paste** to paste the specified file or folder to the destination folder.

### Delete a File or Folder

In the current folder, select the file or folder to be deleted. Click or tap **Delete**, then a prompt message "Are you sure to delete the file" is displayed. Click or tap **OK** to delete the file. Otherwise, click or tap **Cancel** to cancel the deletion operation.

### Rename a File or Folder

Select a specified file or folder, then click or tap **Rename** to input a new filename or folder name with the pop-up numeric keypad. Then, the rename operation is completed.

## 19.6 Factory Settings

Click or tap the **Default** button in the toolbar at the top of the screen or press the

front-panel  key, then a prompt message "Restore default settings?" is displayed. Click or tap **OK** to restore the instrument to its factory default settings, as shown in the table below.

**Table 19.5 Factory Settings**



Parameter	Factory Settings
<b>Horizontal</b>	
Horizontal Scale	2 ns
Horizontal Position	0 s
Delayed Sweep	OFF
Roll	Auto
Fine	OFF

Parameter	Factory Settings
Horizontal Expansion	Center
<b>Acquisition</b>	
Acquisition Mode	Normal
Memory Depth	10 kpts
<b>Vertical</b>	
CH1	ON
CH2	OFF
CH3	OFF
CH4	OFF
Fine	OFF
Vertical Scale	50 mV
Vertical Offset	0 V
Channel Unit	[V]
Channel Coupling	DC
Bias	0 V
BW Limit	OFF
Channel Delay	0 s
Display Label	OFF
Invert	OFF
Attenuation	1X
<b>Trigger</b>	
Trigger Type	Edge Trigger
Trigger Mode	Auto
Source Selection	CH1
Edge Type	Rising
Trigger Coupling	DC
Trigger Holdoff	8 ns
Noise Rejection	OFF
<b>Display</b>	
Display Type	Vector
Persistence Time	Min
Intensity	50%
Grid	FULL
Grid Brightness	50%
Window Transparency	50%
Cursor Brightness	80%
Show Scale	ON
Color Grade	OFF

Parameter	Factory Settings
Waveform Freeze	ON
<b>Measure</b>	
Threshold	OFF
Indicator	OFF
Statistics	OFF
Count	1,000
Type	%
Source	CH1
Upper	90%
Mid	50%
Lower	10%
Amplitude Measurement Method	Auto
Region	Main
<b>Cursor</b>	
Mode	OFF
<b>Manual</b>	
Source	CH1
Select	X
AX BX	OFF
AY	-6 $\mu$ s
BY	6 $\mu$ s
<b>Track</b>	
AX Source	CH1
BX Source	CH1
AX BX	OFF
Track	X
AX	-6 $\mu$ s
BX	6 $\mu$ s
<b>XY</b>	
Select	X
AX BX	OFF
AX	-150 mV
BX	150 mV
<b>Counter</b>	
Source	CH1
Statistic	OFF
Measure	Frequency
Resolution	4

Parameter	Factory Settings
<b>DVM</b>	
Source	CH1
Mode	AC RMS
Beeper	OFF
Upper	1 V
Lower	0 V
<b>Save Image</b>	
Format	*.png
Invert	OFF
Color	Color
Header	ON
Overlay	OFF
<b>Save Wave</b>	
Data Source	Screen
Format	*.bin
<b>Save Setup</b>	
File Type	*.stp
<b>Load Setup</b>	
File Type	*.stp
<b>System Setting</b>	
Beeper	OFF
AUX Out	TrigOut
Input Lock	OFF
Expand	GND
Show Time	ON
<b>Other Setting</b>	
EXT 10M IN	OFF
<b>Auto Config</b>	
Peak to Peak	ON
Live CH	OFF
Overlay	ON
Coupling	OFF
<b>Quick Settings</b>	
Operation	Save Image
Format	*.png



Parameter	Factory Settings
Invert	OFF
Color	Color
<b>Pass/Fail Test</b>	
Enable	OFF
Source	CH1
Y Mask	480 mdiv
X Mask	240 mdiv
Format	*.pf
Format	*.pf
File Name	RigolDS
Aux Output	OFF
Pulse	1 $\mu$ s
Output Event	Fail
Polarity	Positive
Error Action	N/A
<b>Power Analysis</b>	
Display	OFF
Cnt	1000
<b>Power Quality</b>	
Voltage	CH1
Current	CH2
Freq.Ref	Voltage
Type	Percent (%)
Upper	90%
Mid	50%
Lower	10%
<b>Ripple</b>	
Source	CH1
<b>Waveform Recording</b>	
Waveform Recording	OFF
<b>Record</b>	
Interval	10 ns
Frames	1,000
Beeper	
<b>Play</b>	
Minimize	OFF
Mode	
Sequence	
Interval	100 ms

Parameter	Factory Settings
<b>Math Operation</b>	
Invert	OFF
Expand	GND
Display Label	OFF
Grid	FULL
<b>A+B</b>	
Operation	OFF
SourceA	CH1
SourceB	CH1
Scale	500 mV
Offset	0 V
<b>A-B</b>	
Operation	OFF
SourceA	CH1
SourceB	CH1
Scale	500 mV
Offset	0 V
<b>A×B</b>	
Operation	OFF
SourceA	CH1
SourceB	CH1
Scale	500 mU
Offset	0 U
<b>A÷B</b>	
Operation	OFF
SourceA	CH1
SourceB	CH1
Scale	500 mU
Offset	0 U
<b>FFT</b>	
Operation	OFF
Source	CH1
X	Span-Center
Unit	dBm/dBV
Center Frequency	5 MHz
Frequency Span	10 MHz
Vertical Scale	20 dBV
Offset	0 dBV
Window Function	Hanning
Color Grade	OFF
Peak Search	OFF

Parameter	Factory Settings
Peak Number	5
Threshold	5.5 dBV
Excursion	1.8 dBV
Table Order	Amp Order
<b>A&amp;&amp;B</b>	
Operation	OFF
SourceA	CH1
SourceB	CH1
Wave Size	Medium
Offset	0 div
Sensitivity	300 mdiv
Thre.CH1	0 V
Thre.CH2	0 V
Thre.CH3	0 V
Thre.CH4	0 V
<b>A  B</b>	
Operation	OFF
SourceA	CH1
SourceB	CH1
Wave Size	Medium
Offset	0 div
Sensitivity	300 mdiv
Thre.CH1	0 V
Thre.CH2	0 V
Thre.CH3	0 V
Thre.CH4	0 V
<b>A^B</b>	
Operation	OFF
SourceA	CH1
SourceB	CH1
Wave Size	Medium
Offset	0 div
Sensitivity	300 mdiv
Thre.CH1	0 V
Thre.CH2	0 V
Thre.CH3	0 V
Thre.CH4	0 V
<b>!A</b>	
Operation	OFF
SourceA	CH1
Wave Size	Medium

Parameter	Factory Settings
Offset	0 div
Sensitivity	300 mdiv
Thre.CH1	0 V
Thre.CH2	0 V
Thre.CH3	0 V
Thre.CH4	0 V
<b>Intg</b>	
Operation	OFF
Source	CH1
Scale	500 mV*s
Offset	0 V*s
Bias	0
<b>Diff</b>	
Operation	OFF
Source	CH1
Scale	500 mV/s
Offset	0 V/s
Smooth	5
<b>Sqrt</b>	
Operation	OFF
Source	CH1
Scale	500 mU
Offset	0 U
<b>Lg</b>	
Operation	OFF
Source	CH1
Scale	500 mU
Offset	0 U
<b>Ln</b>	
Operation	OFF
Source	CH1
Scale	500 mU
Offset	0 U
<b>Exp</b>	
Operation	OFF
Source	CH1
Scale	500 mU
Offset	0 U
<b>Abs</b>	
Operation	OFF
Source	CH1

Parameter	Factory Settings
Scale	500 mV
Offset	0 V
<b>Low Pass</b>	
Operation	OFF
Source	CH1
Scale	500 mV
Offset	0 V
$\omega c$	4 kHz
<b>High Pass</b>	
Operation	OFF
Source	CH1
Scale	500 mV
Offset	0 V
$\omega c$	4 kHz
<b>Band Pass</b>	
Operation	OFF
Source	CH1
Scale	500 mV
Offset	0 V
$\omega c1$	4 kHz
$\omega c2$	8 kHz
<b>Band Stop</b>	
Operation	OFF
Source	CH1
Scale	500 mV
Offset	0 V
$\omega c1$	4 kHz
$\omega c2$	8 kHz
<b>AX+B</b>	
Operation	OFF
Source	CH1
Scale	500 mV
Offset	0 V
A	1
B	0
<b>Ref</b>	
Current	Ref1
Source	CH1
VScale	50 mV
VOffset	0 V
Label	REF1

Parameter	Factory Settings
Label Display	OFF
Color	Orange
<b>Decode</b>	
Bus Type	Parallel
Bus Status	OFF
CLK	OFF
Format	Hex
Label	ON
Event Table	OFF
Event Table Format	OFF
<b>Parallel</b>	
BUS	CH1
Threshold	0 V
Endian	Invert
Polarity	Positive
<b>RS232</b>	
TX	CH1
RX	OFF
Threshold	0 V
Polarity	Negative
Baud Rate	9.6 kbps
Data	8 bits
Endian	LSB
Parity	None
Stop Bit	1 bit
<b>I2C</b>	
CLK	CH1
SCL Thre	0 V
SDA	CH2
SDA Thre	0 V
Exchange	SCL/SDA
R/W	Without
<b>SPI</b>	
CLK	CH1
CLK Threshold	0 V
Slope	Rising
MISO	CH2
MISO Threshold	0 V
MOSI	OFF
Mode	Timeout
Timeout	1 $\mu$ s

Parameter	Factory Settings
Polarity	Positive
Width	8
Endian	MSB
<b>LIN</b>	
Source	CH1
Threshold	0 V
Baud Rate	19.2 kbps
Parity	Without
Version	Both
<b>CAN</b>	
Source	CH1
Threshold	0 V
Signal	CAN_L
Baud	1 Mbps
Sample Position	50%
<b>FlexRay</b>	

## 20 System Utility Function Setting

In the **Utility** menu, you can set the I/O parameters and the system-related function parameters. You can enter the "Utility" menu in the following ways.

- Click or tap the Notification Area at the lower-right corner of the screen. Then the **Utility** menu is displayed.
- Click or tap the function navigation icon  at the lower-left corner of the screen, then select **Utility** to enter the **Utility** menu.

### 20.1 I/O Setting

In **Utility** menu, click or tap **IO** to enter the I/O setting menu to configure the following parameters.

#### Network Status

Different prompts will be displayed according to the current network connection status.

- Network Config Succeeded!
- Acquiring IP...
- IP Conflict!
- DISCONNECTED!
- DHCP Config Failed
- Read Status Fail!
- CONNECTED
- Invalid IP
- IP lost
- Please wait...

#### MAC Address

For each instrument, the MAC address is unique. When assigning the IP address for the instrument, the system uses the MAC address to identify the instrument.

#### VISA Address

Displays the VISA address currently used by the the instrument.



## IP Configuration Type

The configuration type of the IP address can be DHCP, Auto IP, or Static IP. In different IP configuration types, the configurations for IP address and other network parameters are different.

- **DHCP**

If "DHCP" is selected, the DHCP server in the current network will assign the network parameters (e.g. IP address, Subnet, Gateway, and DNS) for the instrument.

- **Auto IP**

When "Auto IP" is selected, the instrument will acquire the IP address ranging from "169.254.0.1" to "169.254.255.254" and the subnet mask (255.255.0.0) automatically based on the current network configuration. The "Auto IP" works only when "DHCP" is not selected or connection is failed.

- **Static IP**

If "Static IP" is selected, the instrument is configured with static IP. In this case, you need to disable DHCP and Auto IP manually. Then you need to configure the parameters such as "IP address", "Subnet", "Gateway", and "DNS" manually. At this time, you can self-define the network parameters (e.g. IP address) of the instrument.

- **Set the IP address**

The format of the IP address is nnn.nnn.nnn.nnn. The range of the first segment (nnn) of the address is from 0 to 255 (except 127); wherein, the valid range is from 0 to 223. The range for the other three segments is from 0 to 255. You are recommended to ask your network administrator for an IP address available.

This setting will be saved to the non-volatile memory; if "Load Last" is set to "Last", then DHCP and Auto IP are disabled at the next power-on. The instrument will load the preset IP address automatically.

- **Set the subnet mask**

The format of the subnet mask is nnn.nnn.nnn.nnn. Wherein, the range of "nnn" is from 0 to 255. You are recommended to ask your network administrator for a subnet mask available.

This setting will be saved in the non-volatile memory; if "Load Last" is set to "Last", then DHCP and Auto IP are disabled at the next power-on. The instrument will load the preset subnet mask automatically.

- **Set the default gateway**

You can set this parameter in Static IP mode. The format of the gateway is nnn.nnn.nnn.nnn. The range of the first segment (nnn) is from 0 to 223 (except 127), and the range for the other three segments is from 0 to 255.

You are recommended to ask your network administrator for a gate address available.

This setting will be saved in the non-volatile memory; if "Load Last" is set to "Last", then DHCP and Auto IP are disabled at the next power-on. The instrument will load the preset gateway automatically.

- **Set the DNS address**

You can set this parameter in Static IP mode. The format of the DNS address is "nnn.nnn.nnn.nnn". The range for the first segment (nnn) of the address is from 0 to 223 (except 127); and the range for the other three segments is from 0 to 255. You are recommended to ask your network administrator for an address available.

Generally, you do not need to set the DNS, so this parameter setting can be ignored.



**TIP**

- When the three IP configuration types are all turned on, the priority of the parameter configuration from high to low is "DHCP", "Auto IP", and "Static IP".
- The three IP configuration types cannot be all turned off at the same time.

**mDNS**

Click or tap the mDNS on/off switch to enable or disable the multicast Domain Name System (mDNS). This system is used to provide the function of DNS server for service discovery in a small network without a DNS server.

**Host Name**

A maximum of 26-byte strings can be supported.

**GPIB**

When using the GPIB interface, use the USB-GPIB interface converter to extend the GPIB interface, and then use the GPIB cable to connect the instrument to the PC. Configure the GPIB address. Its settable range is from 1 to 30. By default, it is 1.

**Apply the Network Parameter Setting**

Click or tap **Apply** to validate the current network parameter setting.

## 20.2 Basic Settings

In the **Utility** menu, click or tap **Setup** to enter the basic setting menu.

**Language**

This product supports menus in multiple languages, including the display of the help information, prompt messages, and interface. Click or tap the drop-down button of **Language** to select the specified system language.

### Load last

You can set the system configuration to be recalled when the oscilloscope is powered on again after power-off. Click or tap "Default" or "Last" for **Load last**.

- Last: returns to the setting of the system at last power-off.
- Default: returns to the factory setting of the system.

### Power status

- Switch Off: After the oscilloscope is connected to power, you need to press the power key on the front panel to power on the instrument.
- Switch On: After the the oscilloscope is connected to power, it will be powered on immediately.

### Beeper

Click or tap the **Beeper** on/off switch to enable or disable the beeper. When the beeper is enabled, you can hear the beeper sound in the following situations:

- Use a front-panel key or a menu key
- Use the touch screen
- When a prompt message is displayed

### AUX Out

You can set the type of the signal output from the **[AUX OUT]** connector on the rear panel.

- TrigOut: After this type is selected, at each trigger (hardware trigger), the oscilloscope outputs a signal from the **[AUX OUT]** connector on the rear panel that can reflect the current capture rate of the oscilloscope. If this signal is connected to a waveform display device to measure the frequency, the found measurement result is the same as the current capture rate.
- PassFail: When this type is selected, the instrument can output a positive or negative pulse via the **[AUX OUT]** connector when a successful or failed event is detected. Refer to descriptions in *To Set the Output Form of the Test Results*. Enabling the Aux Output function in "PassFail" menu automatically toggles the **AUX Out** parameter to "PassFail"; setting the **AUX Out** parameter to "TrigOut" automatically disables the Aux Output function in "PassFail" menu.

### Input Lock

Once the input lock is enabled, the input function is disabled, for which you can no longer use the touch screen, front-panel keys (except for the power switch key) and knobs to configure the instrument.

Press the front-panel channel keys in the order of , , ,  to disable the input lock.



### Expand

The waveform display can be set to expand or compress about the "Center" or "GND".

- **Center:** When the vertical scale is changed, the displayed waveform will expand or compress about the center of the display.
- **GND:** When the vertical scale is changed, the displayed waveform will expand or compress about the ground level position of the signal.

### Display Date and Time

Click or tap the **Show Time** on/off switch to turn on/off showing the date and time on the screen. The date is displayed in "yyyy/mm/dd" format, and the time is displayed in "hh:mm:ss" format in the Notification Area at the lower-right corner of the screen. You can set the system date and time so that saved images are marked with the data and time information.

- **Date:** Click or tap the "Date" input field, then the date setting menu is displayed. Select a proper date, then click or tap **OK** to confirm the date modification.  
Otherwise, click or tap  or any area outside this menu to cancel date modification and exit the menu.
- **Time:** Click or tap the "Time" input field, then the time setting menu is displayed. Select the proper hour and minute to set the time. After setup, click or tap **OK** to confirm the setting. Otherwise, click or tap  or any area outside this menu to cancel time modification and exit the menu.

## 20.3 About this Oscilloscope

In **Utility** menu, click or tap **About**, and then you can view the model, version, and other information about this instrument in **About** menu.

- **Model**  
Indicates the product model.
- **Serial Number**  
Indicates the serial number, the unique identification for the product.
- **Firmware**  
Indicates the firmware version number of the product.
- **Hardware**

Indicates the hardware version number of the product.

- **Build**

Indicates the creation time of the software version.

- **Android.Build**

Indicates the creation time of the Android operating system.

- **Android.Version**

Indicates the version number of the Android operating system. For example, 7.1.0.

- **Launcher**

Indicates the desktop UI version number of the Android operating system.

- **WebControl**

Indicates the version number of browser remote control module.

## 20.4 Other Settings

### EXT 10M IN

Controls the on/off state of the rear-panel [10MHz REF IN] interface. You can use the **EXT 10M IN** on/off switch to enable or disable this interface.

### Open Source Acknowledgment

Click or tap **Open Source Acknowledgment** to view the open source acknowledgment of this series oscilloscope in the pop-up window.

## 20.5 Auto Config

In "Utility" menu, click or tap **Auto Config** to enter the menu in which you can configure the **Auto** function.

- Click or tap **Peak to Peak** on/off switch to enable or disable the peak-to-peak priority setting. This function is intended for the shifted signal. If there is a large deviation, you can view the signal waveform in priority when you enable the function.
- Click or tap **Live CH** on/off switch to turn on/off examining channels that are turned on.

If "OFF" is selected, enable the Auto function and 4 analog channels (CH1-CH4) will be examined for signal activity in sequence. If no signal is detected for a specified channel, the channel will be turned off; otherwise, if a signal is detected, the channel will be autoscaled to best display the signal. If "ON" is selected, enable the Auto function and only the channels that are turned on will be examined.

- Click or tap **Overlay** on/off switch to enable or disable the waveform overlay display function. If enabled, waveforms of different channels will be displayed in the same position of the screen; if disabled, waveforms of different channels will be displayed on the screen from top to bottom in sequence.
- Click or tap **Keep Coupling** on/off switch to turn on/off maintaining channel coupling. If "ON" is selected, enable the Auto function and the channel coupling setting is maintained; if "OFF" is selected, the channel coupling is DC coupling by default.

## 20.6 SelfCal

The self-calibration program can quickly make the oscilloscope to work in an optimal state to get the precise measurement results. You can perform self-calibration at any time, especially when the changes of the ambient temperature reach or above 5°C. Make sure that the oscilloscope has been warmed up or operating for more than 30 minutes before the self-calibration.

In "Utility" menu, click or tap **SelfCal**, the self-calibration menu is as shown below.

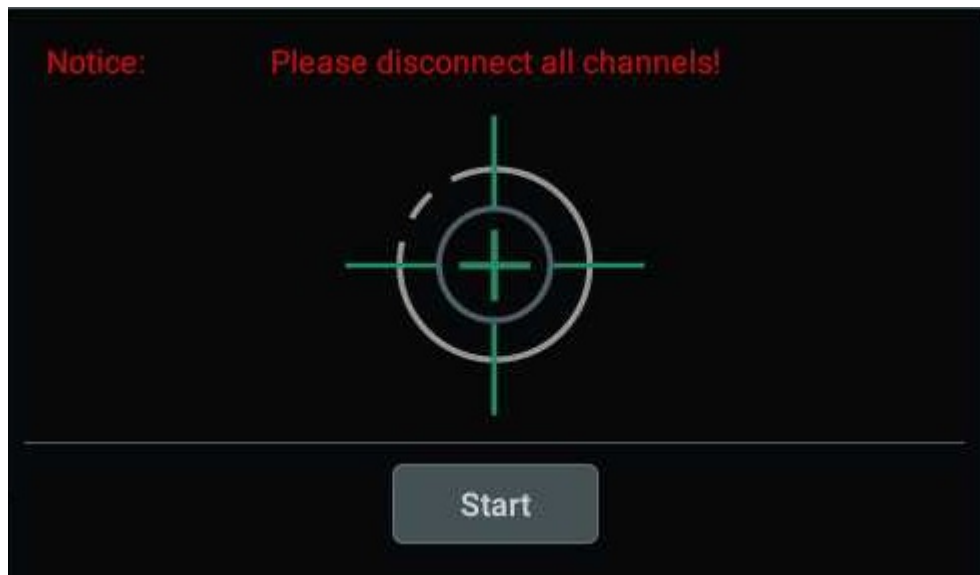

Figure 20.1 Self-calibration Menu

- Click or tap **Start**, and then the oscilloscope will start to execute the self-calibration program.
- After starting the self-calibration program, click or tap **Exit** to cancel self-calibration operation at any time.

- Click or tap **Close** to close the self-calibration information window.

## 20.7 Option List

In the "Utility" menu, click or tap **Option list**, then all the options that have currently been installed can be displayed. For detailed procedures of installing the options, please refer to [Viewing the Option Information and Installation](#).

## 20.8 Quick Action Settings

In **Utility** menu, click or tap **Quick** to enter the menu to configure the quick action key on the front panel.

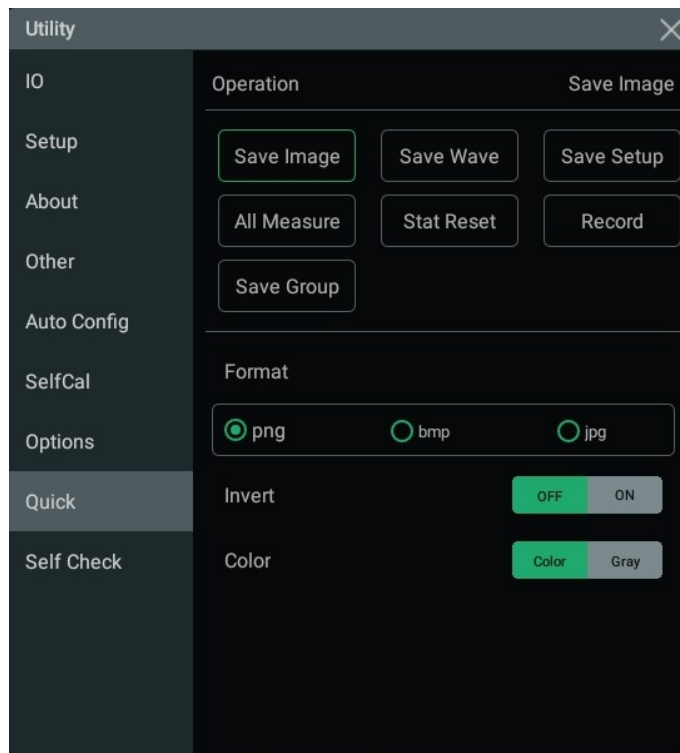



Figure 20.2 Quick Menu

### Save Image

- Click or tap **Save Image**, then **Operation** is set to "Save Image".
- In the **Format** menu item, available image types include "\*.png", "\*.bmp", and "\*.jpg".
- Click or tap the **Invert** on/off switch to enable or disable the invert function.
- Click or tap "Color" or "Gray" for **Color** to select the desired image color.

After setup, click or tap the  key at the upper-right corner of the front panel to capture the current screen and save the image with the specified format. The location where the file is saved depends on the **File Path** setting in Storage menu. For details, please refer to *To Save a File*.

### Save Wave

- Click or tap **Save Wave**, then **Operation** is set to "Save Wave".
- Select "Memory" or "Screen" under **Data Source** as the source of the saved waveform.
- Available options under **Format** include "\*.bin" and "\*.csv".

After setup, click or tap the  key at the upper-right corner of the front panel to save the waveform based on the settings. The location where the file is saved depends on the **File Path** setting in Storage menu. For details, please refer to *To Save a File*.

### Save Setup

Click or tap **Save Setup**, then **Operation** is set to "Save Setup".

After setup, click or tap the  key at the upper-right corner of the front panel to save the setup file suffixed with "\*.stp". The location where the file is saved depends on the **File Path** setting in Storage menu. For details, please refer to *To Save a File*.

### All Measurement

- Click or tap **All Measure**, then **Operation** is set to "All Measure".
- In **All Measure** item, click or tap the drop-down button to select the channel (CH1-CH4) to measure.

After setup, click or tap the  key at the upper-right corner of the front panel to perform the measurement on the specified channel.

### Reset Statistics

- Click or tap **Stat Reset**, then **Operation** is set to "Stat Reset".
- Click or tap "Measure" or "Pass/Fail" under **Stat Reset** to reset all statistics of the "Measure" or "Pass/Fail" function.

After setup, click or tap the  key at the upper-right corner of the front panel. This resets all statistics of the specified function in the **Result** sidebar at the right side of the screen and begins recording statistical data again.



## Waveform Recording

Click or tap **Record**, then **Operation** is set to "Record".

After setup, click or tap the  key at the upper-right corner of the front panel to perform the waveform recording.

## Save Group

- Click or tap **Save Group**, then **Operation** is set to "Save Group".
- Under **Save Group**, select one or multiple items from "Save Image", "Save Wave", and "Save Setup".

After setup, click or tap the  key at the upper-right corner of the front panel to save the selected items based on the settings. The location where the file is saved depends on the **File Path** setting in Storage menu. For details, please refer to [To Save a File](#).

## 20.9 Self-check

In **Utility** menu, click or tap **Self Check** to enter the "Self Check" menu. You can test the following self-check items for the device.

### Key Test

Click or tap **Key Test** to enter the key test interface (virtual front panel key), as shown in the figure below.

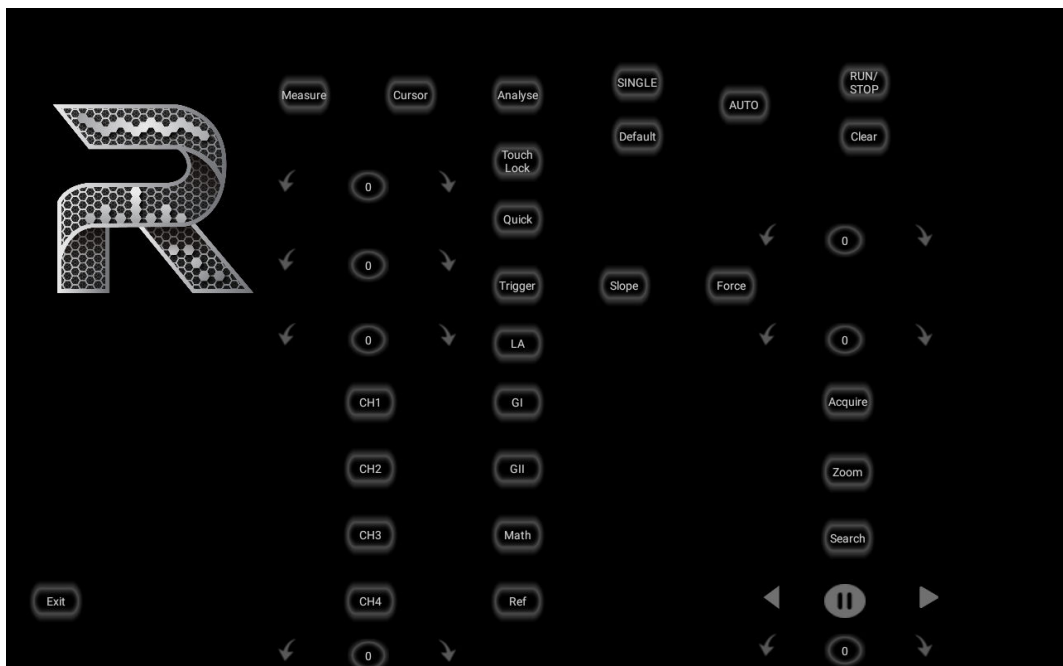

Figure 20.3 Key Test Interface

At this time, you can press the front-panel keys to check whether the virtual keys are highlighted. If yes, it indicates that the keys work normally; if no, it indicates that there's something wrong with the keys. Click or tap **Exit** at the lower-left corner of the

interface or press  for three consecutive times to exit the key test interface.

### Touch Test

Click or tap **Touch Test** to enter the touch screen test interface, as shown in the figure below.

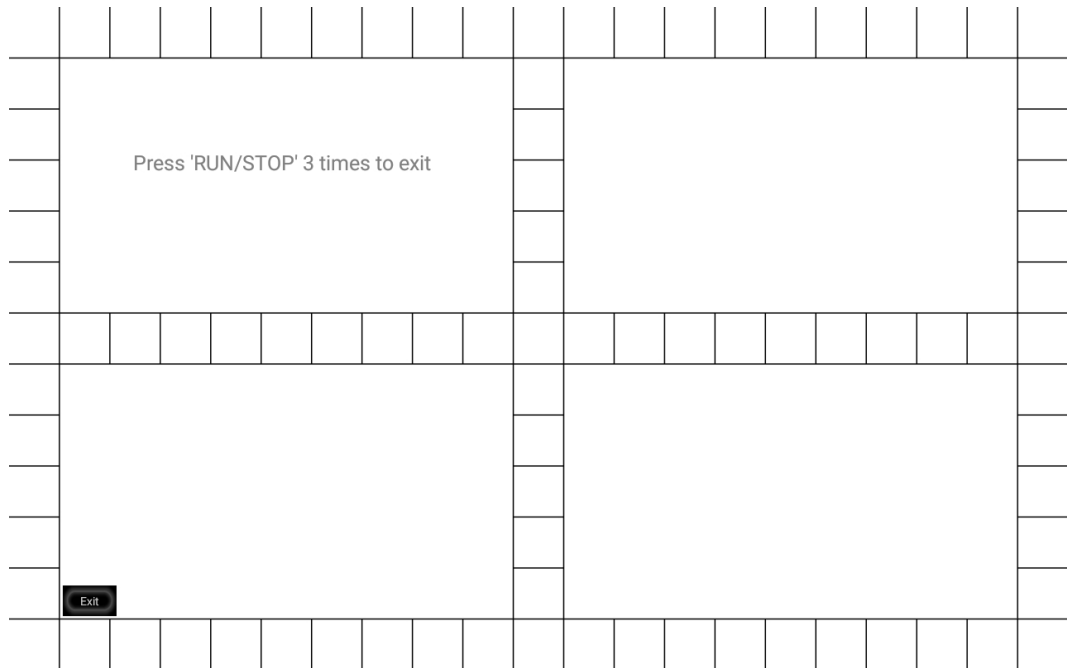

**Figure 20.4 Touch Screen Test Interface**

Slide with your finger on the screen. If there is a line displaying at the empty area where you slide on the screen and the box that you tap turns out to be filled with green background, it indicates that the touch function of this area is normal. Click or

tap **Exit** at the lower-left corner of the interface or press  for three consecutive times to exit the key test interface.

### Screen Test

Click or tap **Screen Test** to enter the screen test interface and check whether the defective pixel exists.

There are 15 screen test interfaces. Click or tap the to switch to the next screen test

interface. Press  for three consecutive times to exit the key test interface.

## Board Test

Click or tap **Board Test**, then the board test interface is displayed. Check whether the status of each module is in good condition.

## 21 Remote Control

The instrument can be remotely controlled by the following three methods:

- **User-defined Programming**

Users can program and control the instrument by using the SCPI (Standard Commands for Programmable Instruments) commands. For details about the SCPI commands and programming, refer to *Programming Guide*.

- **PC Software**

Users can use the PC software to send commands to control the instrument remotely. RIGOL Ultra Sigma is recommended. You can download the software from RIGOL official website (<http://www.rigol.com>).

**Operation Procedures:**

- Set up communication between the instrument and PC.
- Run Ultra Sigma and search for the instrument resource.
- Open the remote command control panel to send commands.

- **Web Control**

This instrument supports Web Control. Connect the instrument to the network, then input the IP address of the instrument into the address bar of the browser of your computer. The web control interface is displayed. Click Web Control to enter the web control page. Then you can view the display of the real-time interface of the instrument. Through the Web Control method, you can migrate the device control to the control terminals (e.g. PC, Mobile, iPad, and other smart terminals) to realize remote control of the instrument. When you first log in to the Web Control, the user name is "admin" and password is "rigol".

This instrument can be connected to the PC via the USB, LAN, or GPIB interface to set up communication and realize remote control through the PC. The remote control can be realized by using SCPI (Standard Commands for Programmable Instruments) commands.

This chapter will illustrate how to use the RIGOL Ultra Sigma software to remotely control the instrument via various interfaces. Note: When communicating with the PC via GPIB, the instrument does not support large data transmission operation such as screen shot and waveform reading.



**CAUTION**

**Before connecting the communication cable, please turn off the instrument to avoid causing damage to the communication interfaces.**

## 21.1 Remote Control via USB

---

### 1. Connect the device

Use the USB cable to connect the rear-panel USB DEVICE interface of the instrument to the USB HOST interface of the PC.

### 2. Search for the device resource

Start up Ultra Sigma and the software will automatically search for the resource currently connected to the PC via the USB interface. You can also click **USB-TMC** to search for the resource.

### 3. View the device resource

The resources found will appear under the "RIGOL Online Resource" directory, and the model number and USB interface information of the instrument will also be displayed.

### 4. Control the instrument remotely

Right-click the device resource name and select "SCPI Panel Control" to open the remotely command control panel. Then you can send commands and read data through the panel. For details about the SCPI commands and programming, refer to the Programming Guide of this instrument.

## 21.2 Remote Control via LAN

---

### 1. Connect the device

Use the network cable to connect the instrument to your local area network (LAN).

### 2. Configure network parameters

Configure the network parameters of the instrument according to "*#unique\_196*".

### 3. Search for Search device resource

Start up Ultra Sigma and click **LAN** to open the panel as shown in the figure below. Click **Search** and the software searches for the instrument resources currently connected to the LAN and the resources found are displayed at the right section of the window as shown in the figure below. Click **OK** to add it.

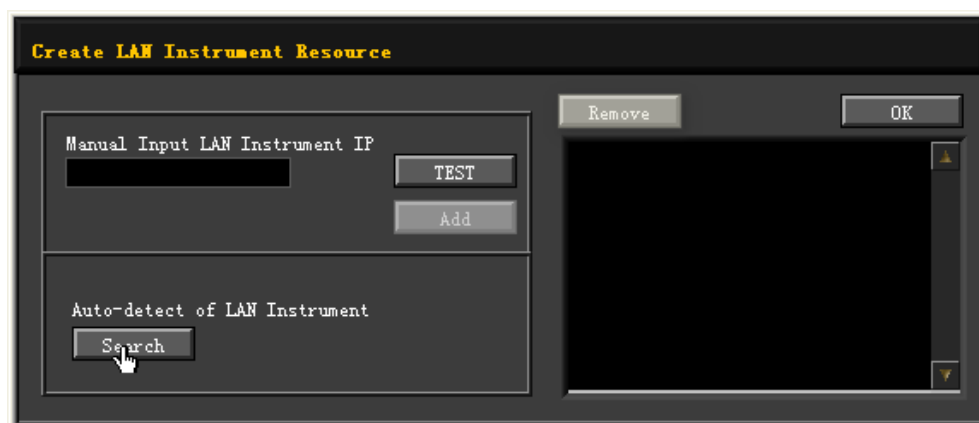

Besides, you can input the IP address of the instrument manually into the text field under "Manual Input LAN Instrument IP", then click **TEST**. If the instrument passes the test, click **ADD** to add the instrument to the LAN instrument resource list in the right section; if the instrument fails the test, please check whether the IP address that you input is correct, or use the auto search method to add the instrument resource.

#### 4. View the device resource

The resources found will appear under the "RIGOL Online Resource" directory.

#### 5. Control the instrument remotely

Right-click the device resource name and select "SCPI Panel Control" to open the remotely command control panel. Then you can send commands and read data through the panel.

#### 6. Load LXI webpage

As this instrument conforms to LXI CORE 2011 DEVICE standards, you can load LXI web page through Ultra Sigma (right-click the instrument resource name and select "LXI-Web"). Various important information about the instrument (including the model, manufacturer, serial number, description, MAC address, and IP address) will be displayed on the web page. You can also directly input the IP address of the instrument in the address bar of the PC browser to load the LXI web page.

## 21.3 Remote Control via GPIB

### 1. Connect the device

Use the USB-GPIB interface converter to extend the GPIB interface for the instrument, and then use the GPIB cable to connect the instrument to the PC to realize remote control.

### 2. Install the driver of GPIB card

Correctly install the driver of the GPIB card which has been connected to the PC.

### 3. Set the GPIB address

Click or tap the Notification Area at the lower-right corner of the screen, then the **Utility** menu is displayed. Click or tap **IO**, and then click or tap the input field of **GPIB** to input the GPIB address with the pop-up numeric keypad.

#### 4. Search for the device resource

Start Ultra Sigma, and then click **GPIB**. A window is displayed as shown in *Figure 21.1*. Click **Search** and the software searches for the instrument resource currently connected to the PC via the GPIB interface. The resource found is displayed at the right side of the window, as shown in *Figure 21.2*. Click **OK** to add it.

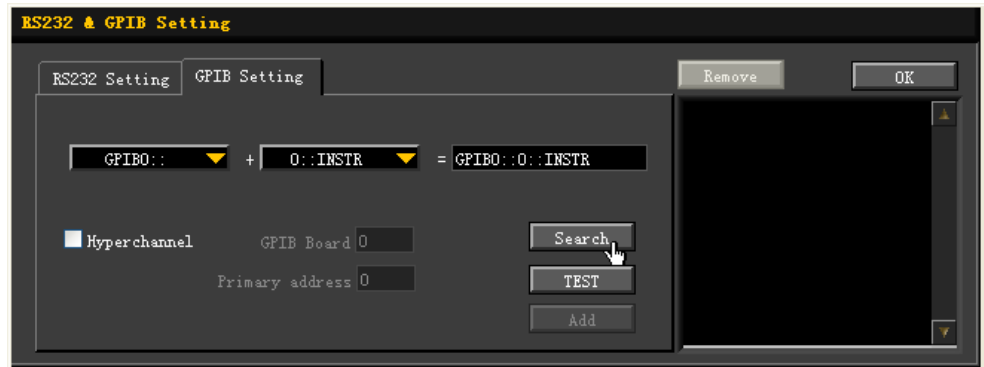

Figure 21.1 Search for the Available Device



Figure 21.2 Confirm the Available Device

#### 5. View the device resource

Click **OK** to go back to the main interface of Ultra Sigma. The searched instrument resource will be displayed under the directory of "RIGOL Online Resource".

#### 6. Control the instrument remotely

Right-click the device resource name. In the displayed menu, select "SCPI Panel Control" to open the programming command control panel. Then you can input commands to send commands and read data.

## 22 Troubleshooting

### 1. When I power on the instrument, the instrument stays black and does not display anything.

- a. Check whether the power supply has been connected correctly.
- b. Check whether the power key is really pressed.
- c. Check whether the fuse is blown. If you need to replace the fuse, use only the specified fuse that conforms to the product.
- d. Restart the instrument after finishing the above inspections.
- e. If the problem still persists, please contact RIGOL.

### 2. The USB storage device cannot be recognized.

- a. Check whether the USB storage device can work normally when connected to other instruments or PC.
- b. Make sure that the USB storage device is FAT32 format and flash type. The instrument doesn't support hardware USB storage device.
- c. After restarting the instrument, insert the USB storage device again to check whether it can work normally.
- d. If the USB storage device still cannot work normally, please contact RIGOL.

### 3. How do you set the amplitude of the waveform in dBm?

- a. Select the desired channel.
- b. In the channel setting interface, check whether HighZ under **OutputSet** is set to "On". If yes, you cannot set the amplitude of the waveform in dBm at this time. Select "Off" to disable the HighZ, and use the numeric keypad, the arrow keys, and knob to set it to a proper value.
- c. Select the desired waveform, tap the Amplitude menu label, and then input the desired value by using the numeric keypad. Then select the unit "dBm" from the pop-up menu.

### 4. The touch-enabled operation does not work.

- a. Check whether you have locked the touch screen. If yes, unlock the touch screen.
- b. Check whether the screen or your finger is stained with oil or sweat. If yes, please clean the screen or dry your hands.



- 
- c. Check whether there is a strong magnetic field around the instrument. If the instrument is close to the strong magnetic field (e.g. a magnet), please move the instrument away from the magnet field.
  - d. If the problem still persists, please contact RIGOL.

## 23 Appendix

### 23.1 Appendix A: Options and Accessories

Order Information	Order No.
<b>Base Unit</b>	
70 MHz, 2 GSa/s, 50 Mpts, 2CH DHO	HDO1072
70 MHz, 2 GSa/s, 50 Mpts, 4CH DHO	HDO1074
100 MHz, 2 GSa/s, 50 Mpts, 2CH DHO	HDO1102
100 MHz, 2 GSa/s, 50 Mpts, 4CH DHO	HDO1104
200 MHz, 2 GSa/s, 50 Mpts, 2CH DHO	HDO1202
200 MHz, 2 GSa/s, 50 Mpts, 4CH DHO	HDO1204
<b>Standard Accessories</b>	
Power cord (based on destination country)	— —
USB Cable	— —
4 Passive HighZ Probes (350 MHz) Standard for HDO1204, 2 Passive HighZ Probes (350 MHz) Standard for HDO1202	PVP2350
4 Passive HighZ Probes (150 MHz), Standard for HDO1104/HDO1074	PVP3150
2 Passive HighZ Probes (150 MHz), Standard for HDO1102/HDO1072	PVP3150
<b>Bandwidth Upgrade Option</b>	
70 MHz to 100 MHz Upgrade Option	HDO1000-BWU7T10
70 MHz to 200 MHz Upgrade Option	HDO1000-BWU7T20
100 MHz to 200 MHz Upgrade Option	HDO1000-BWU10T20
<b>Memory Depth Upgrade Option</b>	
100 Mpts Memory Depth Upgrade Option	HDO1000-RLU-01

#### NOTE

For all the base units, accessories, and options, please contact the local office of RIGOL.

### 23.2 Appendix B: Warranty

RIGOL TECHNOLOGIES CO., LTD. (hereinafter referred to as RIGOL) warrants that the product mainframe and product accessories will be free from defects in materials and workmanship within the warranty period. If a product proves defective within the warranty period, RIGOL guarantees free replacement or repair for the defective product.

To get repair service, please contact your nearest RIGOL sales or service office.

---

There is no other warranty, expressed or implied, except such as is expressly set forth herein or other applicable warranty card. There is no implied warranty of merchantability or fitness for a particular purpose. Under no circumstances shall RIGOL be liable for any consequential, indirect, ensuing, or special damages for any breach of warranty in any case.

#### HEADQUARTER

**RIGOL TECHNOLOGIES CO., LTD.**  
No.8 Keling Road, New District, Suzhou,  
JiangSu, P.R.China  
Tel: +86-400620002  
Email: info@rigol.com

#### EUROPE

**RIGOL TECHNOLOGIES EU GmbH**  
Carl-Benz-Str.11  
82205 Gilching  
Germany  
Tel: +49(0)8105-27292-0  
Email: info-europe@rigol.com

#### NORTH AMERICA

**RIGOL TECHNOLOGIES, USA INC.**  
10220 SW Nimbus Ave.  
Suite K-7  
Portland, OR 97223  
Tel: +1-877-4-**RIGOL**-1  
Fax: +1-877-4-**RIGOL**-1  
Email: info@rigol.com

#### JAPAN

**RIGOL JAPAN CO., LTD.**  
501, LATORRETTA, 2-37-1,  
Numabukuro,  
Nakano-Ku, Tokyo, Japan  
Tel: +81-3-6262-8932  
Fax: +81-3-6262-8933  
Email: info-japan@rigol.com

---

**RIGOL**® is the trademark of **RIGOL TECHNOLOGIES CO., LTD.** Product information in this document subject to update without notice. For the latest information about **RIGOL**'s products, applications and services, please contact local **RIGOL** channel partners or access **RIGOL** official website: [www.rigol.com](http://www.rigol.com)