

GEODESIC MONKEY CLIMBER

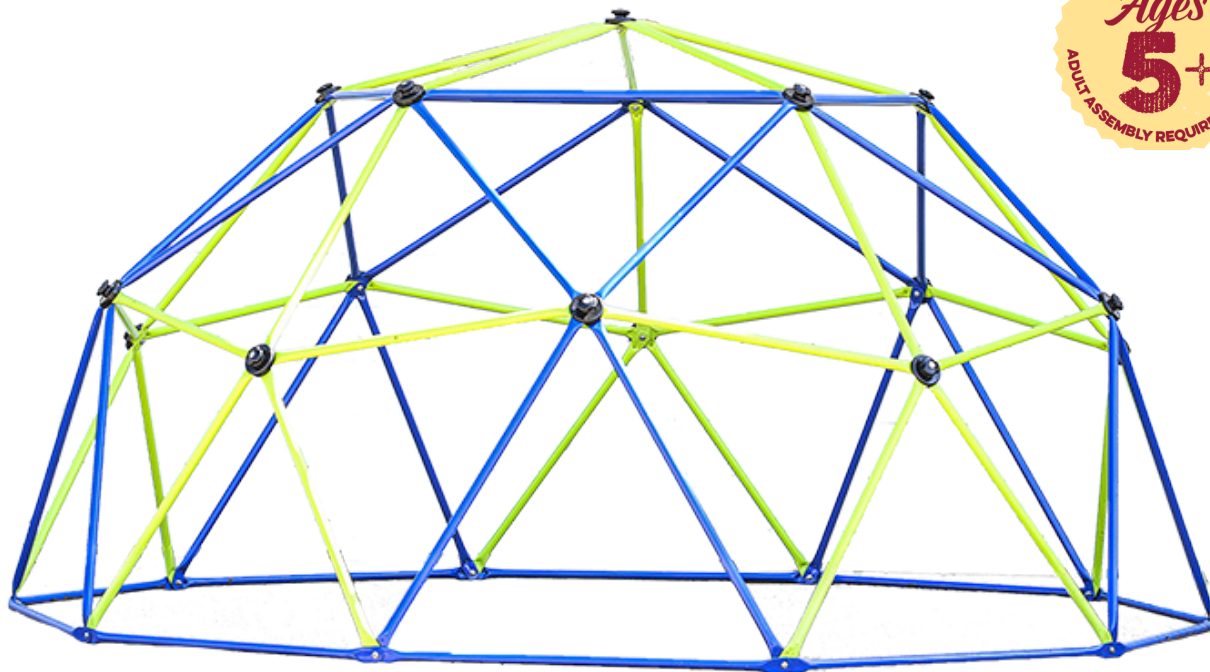

USER MANUAL

ASSEMBLY • OPERATION • MAINTENANCE • SAFETY



Geodesic Monkey Climber • MM00191



M&M SALES ENTERPRISES, INC.

Dubuque, Iowa 877.242.0154

mandmsalesinc.com

SAFETY INSTRUCTIONS

As with any kind of sport, the risk of injury is present when using play equipment and climbers. Adult supervision is required. Please read, understand, and practice all safety instructions.

- Do not allow the player to use the Geodesic Monkey Climber™ when supervision is inadequate. Always provide supervision for children of all ages and skill levels.
- Do not allow the player to use the Geodesic Monkey Climber™ when it's wet or not properly installed.
- Do not allow the player to damage the pole coatings.
- Do not place the Geodesic Monkey Climber™ over any hard surface such as concrete, asphalt, or packed earth. Check area regularly.
- Place the Geodesic Monkey Climber™ over an area that is soft and even and free of obstacles.
- Cover the entire play area with adequate surfacing materials as noted in CPSC's *Playground Safety Handbook* (www.cpsc.gov).
- Never attach ropes, lines, pet leashes, or other items to this product that could present a safety concern or hazard.
- Make certain the player is wearing well-fitting shoes. Avoid loose-fitting clothing could be potentially hazardous such as ponchos, scarves, jackets with neck drawstrings, helmets with straps, etc.
- Check the entire structure regularly to ensure all pieces are functional and in good condition. Replace damaged poles and tighten loose bolts and nuts as needed.

The data and information below are excerpted from the CPSC website and publication ***Outdoor Home Playground Safety Handbook*** (Publication #324*2005). The full version can be obtained by visiting <http://www.cpsc.gov>.

One of the most important things you can do to reduce the likelihood of serious head injuries is to install shock-absorbing protective surfacing under and around your play equipment. The protective surfacing should be applied to a depth that is suitable for the equipment height in accordance with ASTM F1292. There are different types of surfacing to choose from; whichever product you select, follow these guidelines:

NOTE: Do not install home playground equipment over concrete, asphalt, or any other hard surface. A fall onto a hard surface can result in serious injury to the equipment user. Grass and dirt are not considered protective surfacing because wear and environmental factors can reduce their shock absorbing effectiveness. Carpeting and thin mats are generally not adequate protective surfacing. Ground level equipment—such as a sandbox, activity wall, playhouse or other equipment that has no elevated play surface—does not need any protective surfacing.







LOOSE-FILL SURFACING MATERIALS

- *Maintain a minimum depth of 9 inches of loose-fill materials such as wood mulch/chips, engineered wood fiber (EWF), or shredded/recycled rubber mulch for equipment up to 8 feet high; and 9 inches of sand or pea gravel for equipment up to 5 feet high. NOTE: An initial fill level of 12 inches will compress to about a 9-inch depth of surfacing over time. The surfacing will also compact, displace, and settle, and should be periodically refilled to maintain at least a 9-inch depth.*
- *Use a minimum of 6 inches of protective surfacing for play equipment less than 4 feet in height. If maintained properly, this should be adequate. (At depths less than 6 inches, the protective material is too easily displaced or compacted.)*
- *Use containment, such as digging out around the perimeter and/or lining the perimeter with landscape edging. Don't forget to account for water drainage.*
- *Check and maintain the depth of the loose-fill surfacing material. To maintain the right amount of loose-fill materials, mark the correct level on play equipment support posts. That way you can easily see when to replenish and/or redistribute the surfacing*
- *Do not install loose fill surfacing over hard surfaces such as concrete or asphalt.*

GEODESIC MONKEY CLIMBER







#MM00191

PARTS LIST

Part Number	Diagram	Description	QTY
A		Long Pole Blue Color	30
B		Short Pole Green Color	30
C		Grip	16
D		Barrel Bolt	16
E		Long Bolt	16
F		Short Bolt	10

PARTS LISTED CONTINUED ON NEXT PAGE

PARTS LIST – CONTINUED FROM PREVIOUS PAGE

Part Number	Diagram	Description	QTY
G		Nut (for the 10 joints of the base layer)	10
H		Washer	36
I		Tool	2
J		Tool	1
K		Nut (for all other joints except for these of the base layer)	16
M		Long Pole (packed in the red plastic bag)	5

BEFORE ASSEMBLY ---

- Measure the proper area for placement of the Geodesic Monkey Climber™ on a level, well-drained ground with proper loose-fill surfacing materials (refer to Safety section).
- Do not place the Geodesic Monkey Climber™ over any hard surface such as concrete, asphalt, and packed earth.
- Place the Geodesic Monkey Climber™ in a well-lit area.
- Do not place the Geodesic Monkey Climber™ near any other recreational devices or structures such as a seesaw, slide, swing, swimming pool, hot tub, etc.
- At least two adults are required for the assembly of the Geodesic Monkey Climber™.
- Check that you have all labeled parts according to the enclosed **Parts List**. If you need any replacement(s) or have questions, please contact our customer service team at 877-242-0154.
- Ensure all parts are dry before and during installation.
- Slightly loosen the bolts of two joints next to it if you feel it to be a bit difficult to finish assembling the last joint of each layer (**VERY IMPORTANT**).
- Keep objects and possible hazards such as toys, tree branches, laundry lines, and electrical wires in all directions away from the Geodesic Monkey Climber™.

IMPORTANT:

At least two adults are required to assemble and move the Geodesic Monkey Climber™.

GEODESIC MONKEY CLIMBER™

#MM00191

ASSEMBLY STEPS

From bottom to the top of the Geodesic, there are six steps to follow ...

STEP 1 - FRAME LAYOUT

Place **the 10 pieces of part #A** (long blue pole in transparent bag) on flat surface as shown below. You'll see 10 joints after finishing this step.

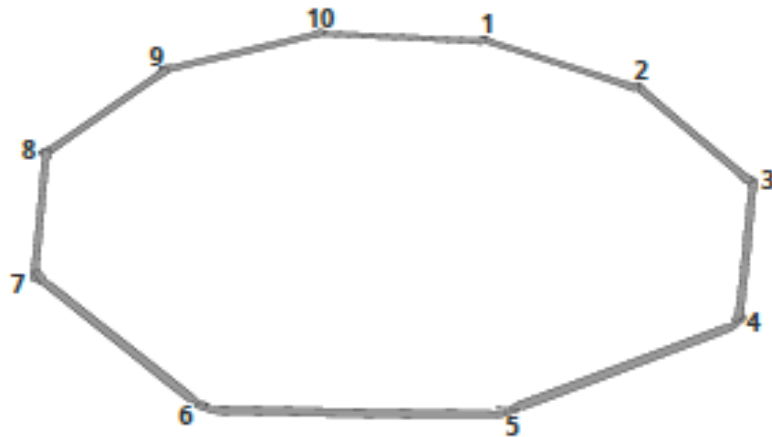

STEP 2 - FINISH THE FIRST LAYER

(a) Start from any one of the 10 joints. Connect **one part #B (short green pole in transparent bag) and one part #A** with a part #F (short bolt), a part #G, and two parts #H. Use the tools (parts I and J) to tighten them together.

ATTENTION: Insert the bolt from the outside of the dome climber. That is, the nut should be inside on the first layer of the Geodesic Monkey Climber™.

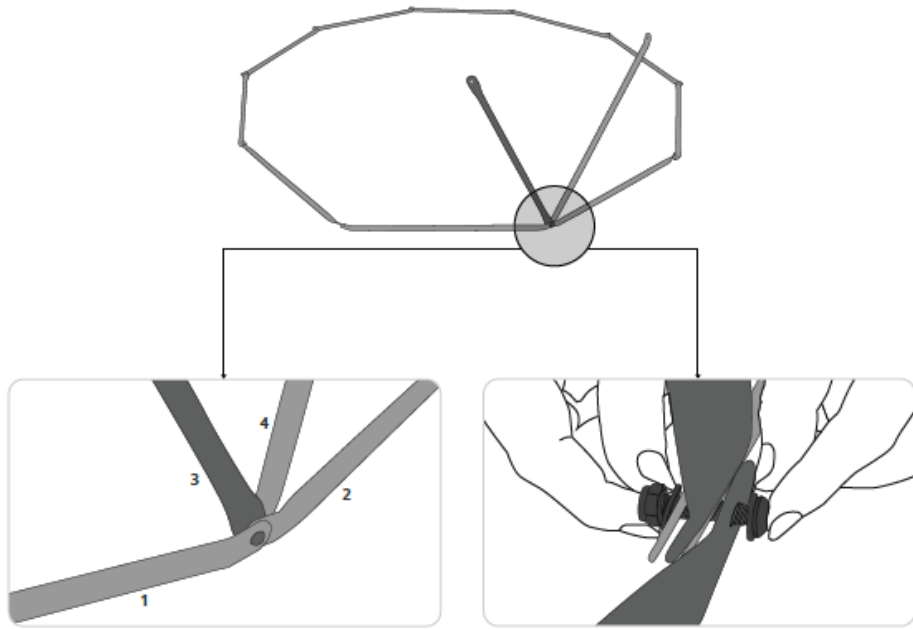

(b) Repeat until you finish assembling the 10 joints.

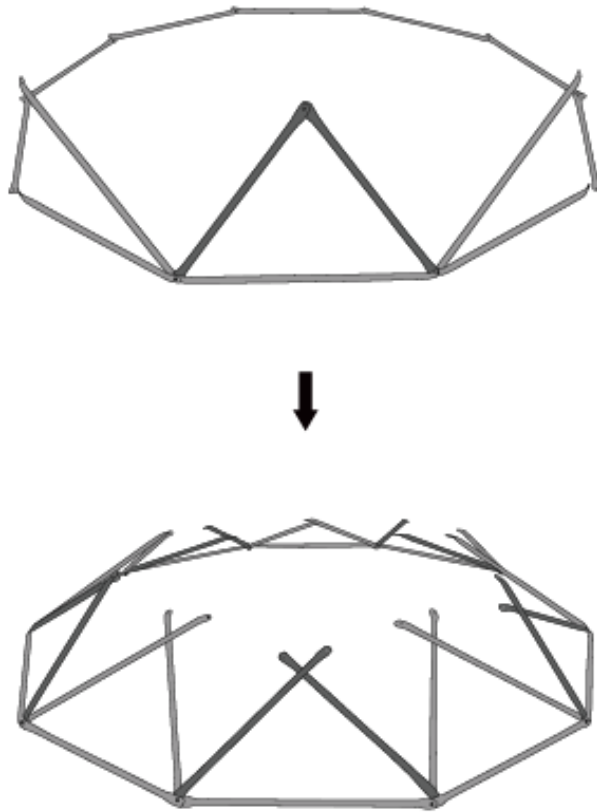

IMPORTANT: The following tips apply to all subsequent assembly steps.

- Add all poles counterclockwise.
- Insert all bolts (except bottom layer) from the inside of the dome climber and add the nut from the outside. That is, insert the part #E (long bolt) into the preformed hole, fix it with the part #H and the part #K. See details as shown below.

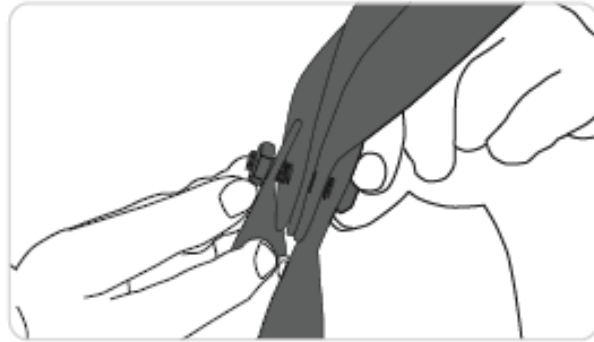

STEP 3 - FINISH THE SECOND LAYER

- (a) Start from a joint where the two parts #B (short green pole) come across. Add another **three parts #B** to the chosen joint with a part #E, a part #H, and a part #K. Use the tools (parts I and J) to tighten them together.

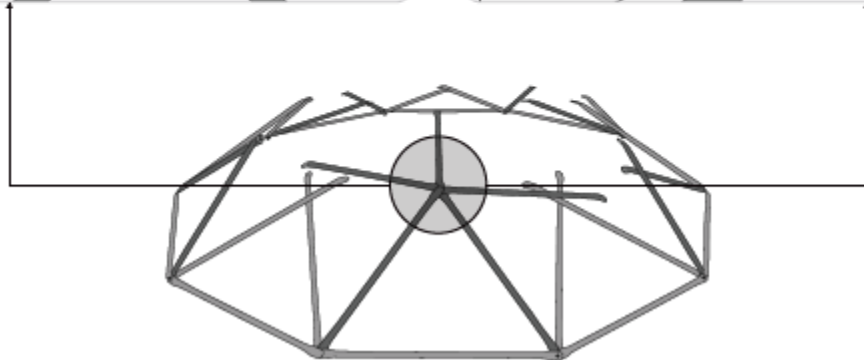
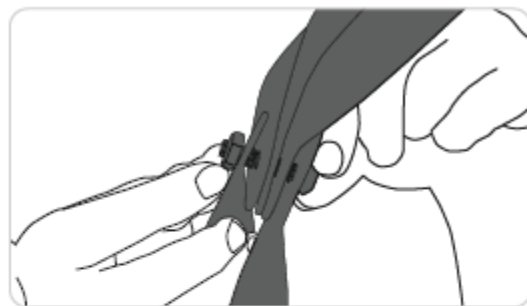
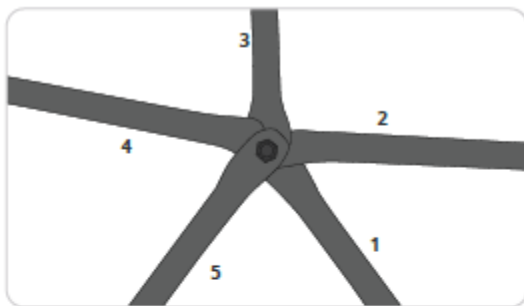

(b) Move to the next joint, connect **two parts #A (long blue pole)** and **one part #B (short green pole)** counterclockwise with a part #E (long bolt), a part #H, and a part #K. Use the tools (parts I and J) to tighten them together as before.

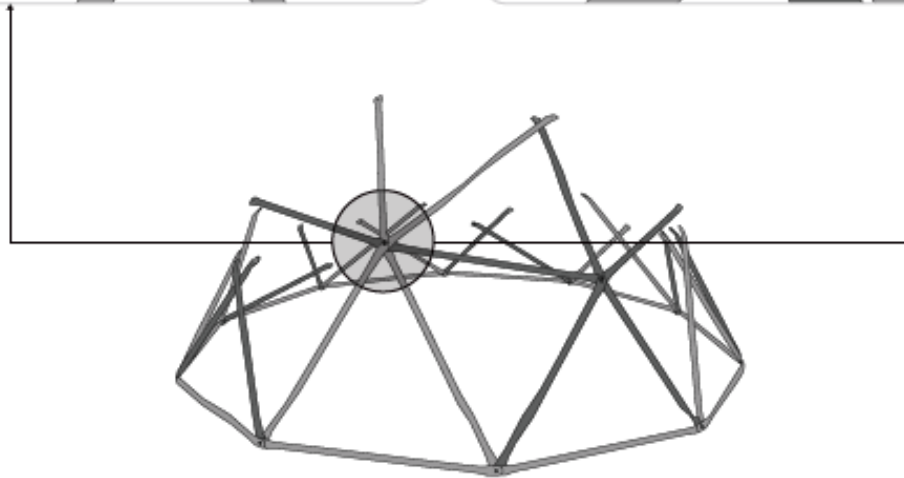

(c) Repeat until you finish assembling all the 10 joints.

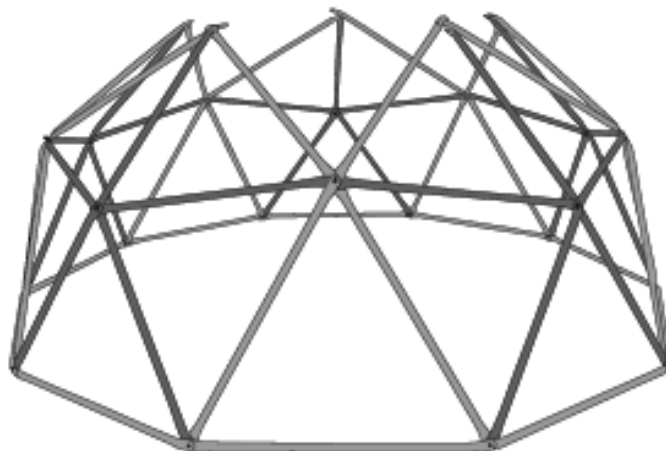

STEP 4 - FINISH THE THIRD LAYER

- (a) Start from any one of the joints created by Step 3. Connect **two parts #M (long pole in red bag) and one part #B** with a part #E, a part #H, and a part #K. Use tools (parts I and J) to tighten together.
- (b) Move to the next joint, connect **one part #M and one part #B** with a part #E, a part #H, and a part #K. Tighten them with the tools part #I and part #J. Repeat until there is one joint left.
- (c) Finish connecting the last joint of the second layer by adding **one part #B with a part #E**, a part #H, and a part #K. Tighten them with the tools part #I and part #J.

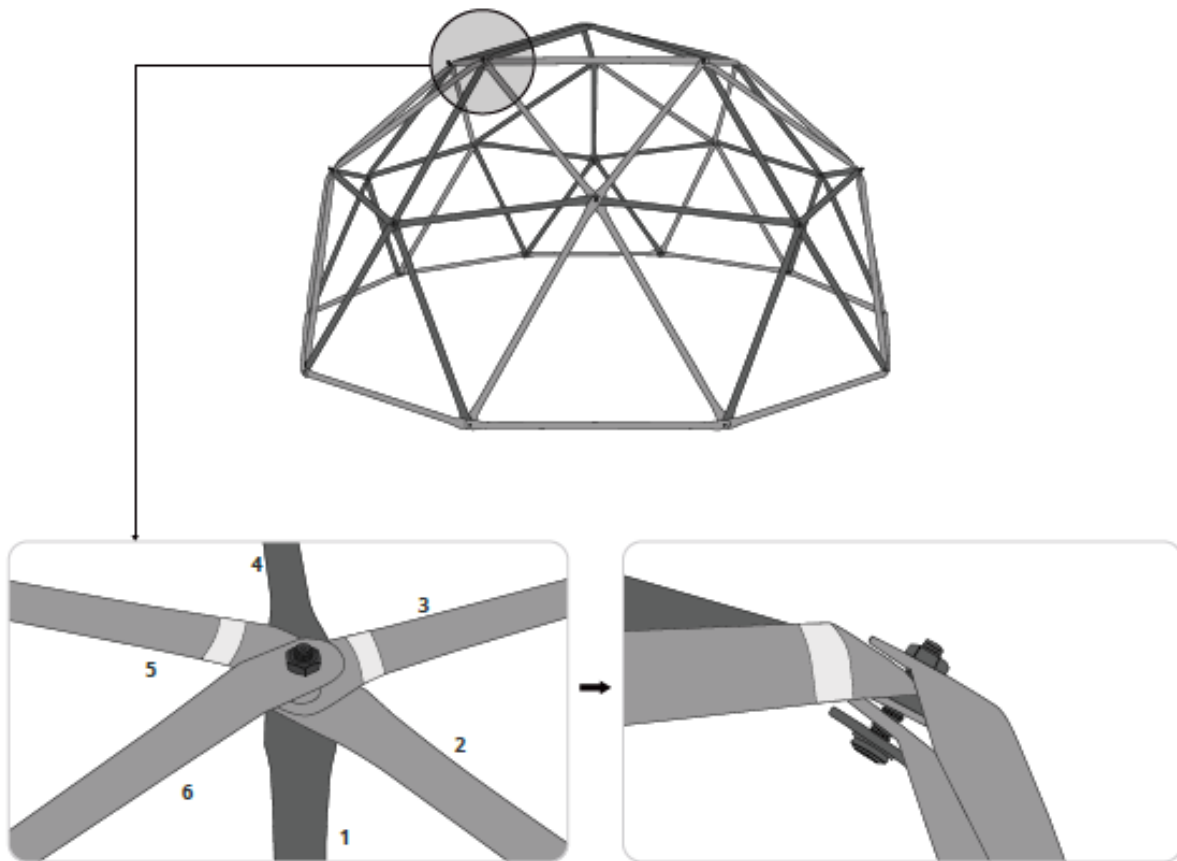

STEP 5 - FIX THE CENTRAL JOINT

A central joint would come into being after you finish Step 4. Put a **part #E**, a **part #H**, and a **part #K** into the **central point**, tighten them with the tools (parts I and J).

IMPORTANT: if you feel it is a bit difficult to finish assembling the last joint of each layer, slightly loosen the bolts of two adjacent joints.

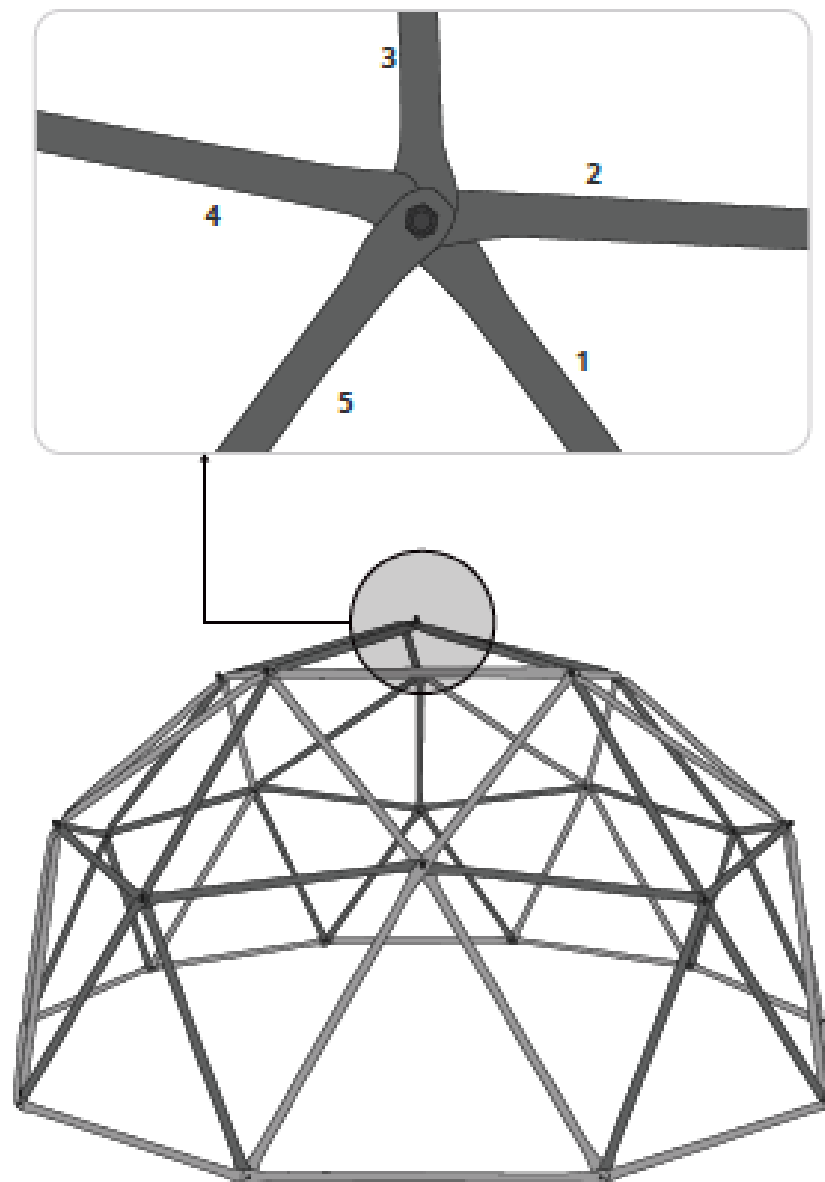

STEP 6 - ADD GRIPS

Cover each joint, except for those 10 joints near the ground, with a grip, **part #C**. Insert a **part #D** (barrel nut) into the preformed hole, then tighten them with the tool **part #I**.

NOTE: The gap of the grip should be next to the top pole as shown below.

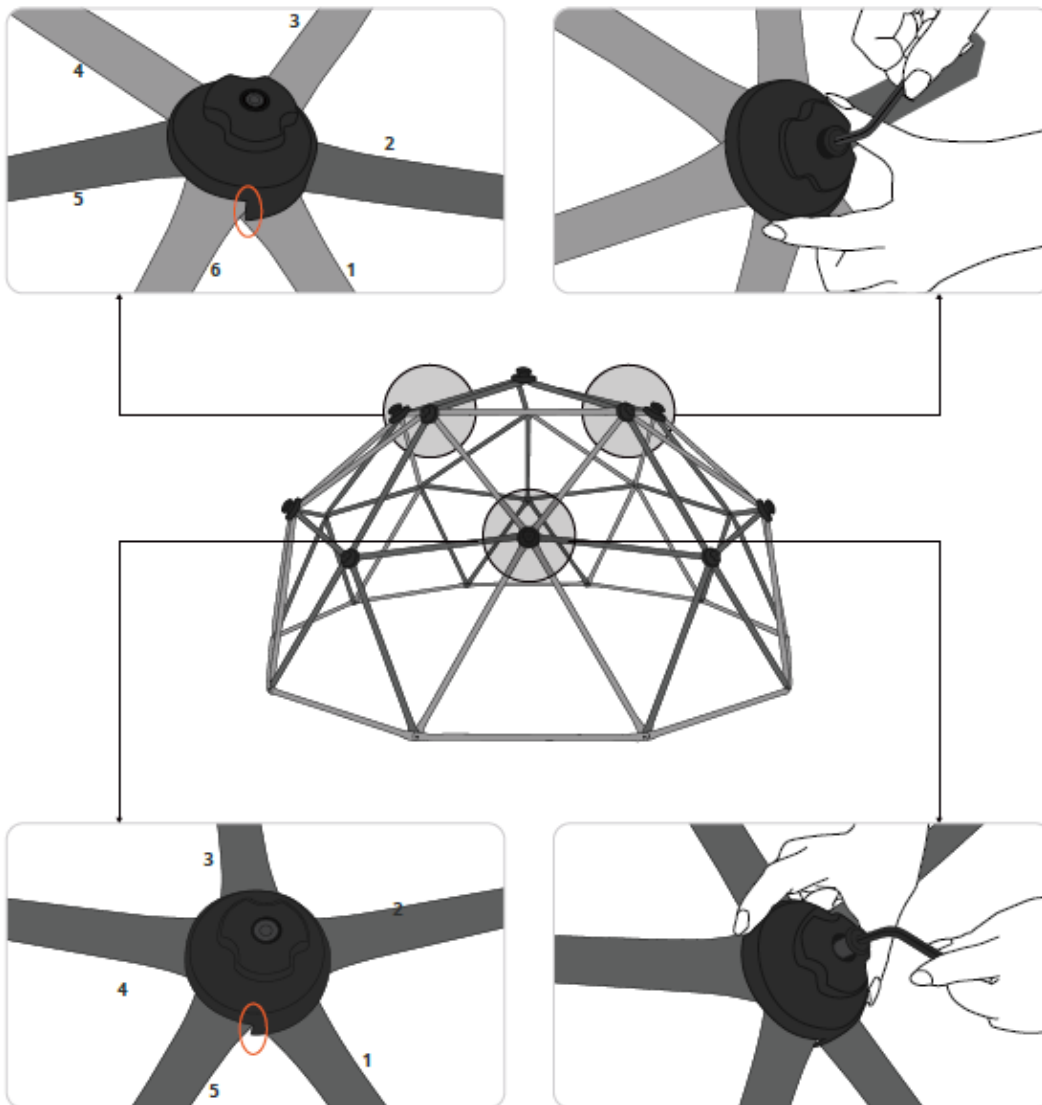

Congratulations! Your Geodesic Monkey Climber™ is completed!

If you have any questions about the assemble, please email: sales@mandmsalesinc.com.

MAINTENANCE

With proper installation and maintenance, the Geodesic Monkey Climber™ by M&M Sales Enterprises, Inc. will provide your kids with years of fun and enjoyment.

We recommend following all regular maintenance procedures:

- Follow all safety instructions.
- Follow all installation instructions.
- Be careful with the protective coatings of the poles, as they help guard against rust.
- Tighten all hardware, but do not overtighten which could damage the thread or cause cracking.
- Routinely check all parts and replace as needed.
- Repaint with non-lead-based paints if signs of oxidation and/or rust appear.
- Store the Geodesic Monkey Climber™ in a dry area with good ventilation when it's not in use.
- Do not use any abrasive cleansers. Wipe dust and dirt with a soft, damp cloth.

Contact the M&M Sales Ent. Inc. Customer Service Team with any questions or if you may need any replacement parts. We're happy to help!

M&M Sales Enterprises, Inc.
1300 Synergy Court
Dubuque, Iowa 52002
877-242-0154
www.mandmsales.com