

EL PRIMA EXP



Victoria Arduino

INSPIRED BY YOUR PASSION.



Victor

EL PRIMA EXP

HELLO!

LIFESTYLE EXPLORERS



We're the ones **who live in the present to create the future.** We are **curious, explorers, lovers of beauty.** We're the ones **that inhabit every land of taste,** the ones **that dream today about the trends of tomorrow.**

Welcome to **E1 Prima EXP**, the single group that makes every recipe and every ingredient unique, cup after cup.

LIFE LOVES STYLE



Settings where total quality is the essence of every lifestyle experience expand and exchange influences to generate new opportunities for product enjoyment.

From the roasteries and coffee shops who have spread the culture of quality coffee, the experience of quality drinks is growing into a landscape of constantly renewing coffee and non-coffee oriented environments.

E1 Prima EXP leads the way at those precious times where design meets the intensity of every emotion.



SPECIALTY COFFEES



DEDICATED TO THOSE WHO LOOK FURTHER



E1 Prima EXP was created for people who today imagine the tastes of tomorrow. The versatility and compactness of the single group crosses paths with the technology of a professional machine. Here, we see all the expertise of Victoria Arduino and ease-of-use for espresso, milk, pure brew coffee, through to taste experimentation, and right up to the limits of the most innovative mixology. E1 Prima EXP is the machine that changes the rules and stretches the boundaries.



Every day, new places emerge where innovation from experience attracts lifestyle explorers. These are settings that share a devotion to good taste in every area of experience and the urge to experiment that produces excellence of extraction: this is where we find E1 Prima EXP.



HOME



BUSINESS

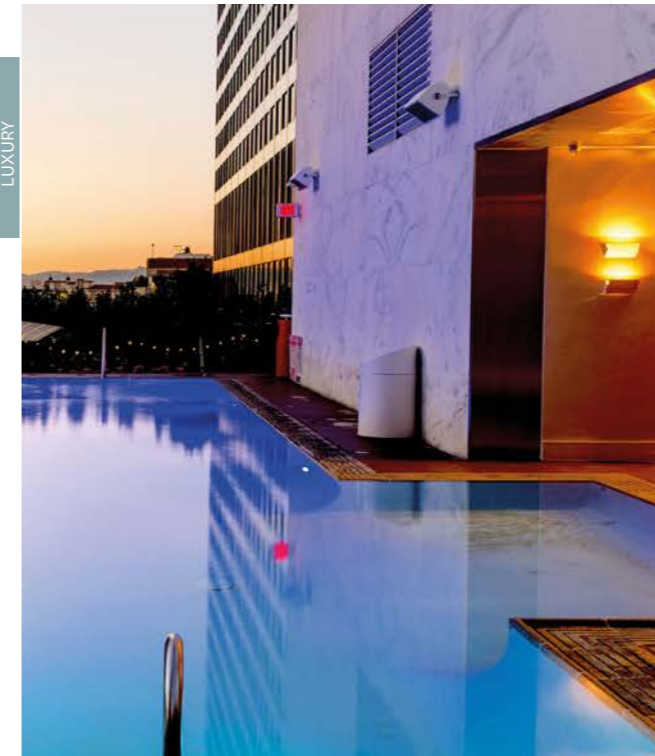

LUXURY

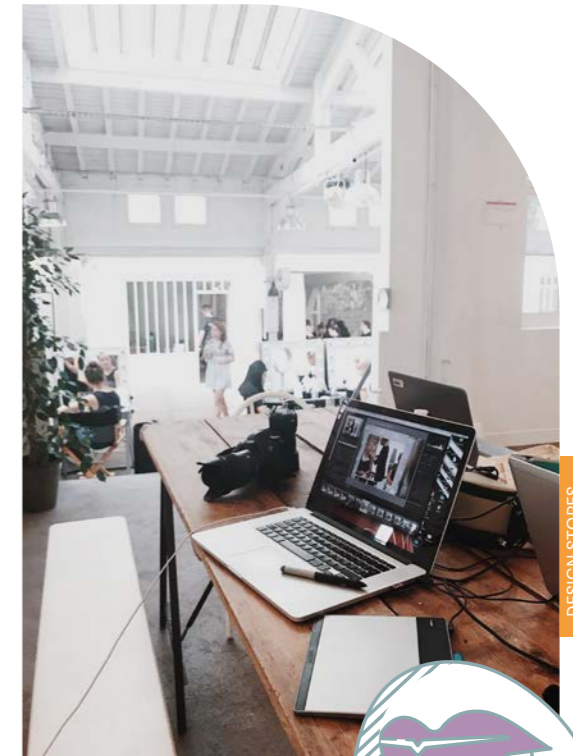

DESIGN STORES



MIXOLOGIST



HI-TECH SPACES

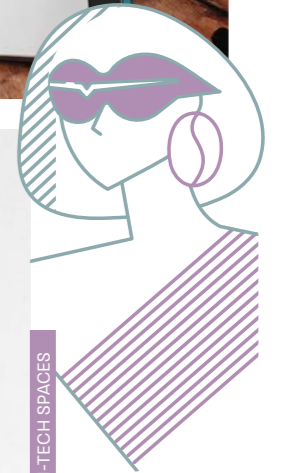

QUALITY EXTRACTION IN EVERY RECIPE FOR SETTINGS WHERE BEAUTY RESIDES

PERFORMANCE AND DESIGN

Extraction quality meets ergonomic intelligence and the iconic nature of Victoria Arduino.

DIGITAL AND SUSTAINABLE

Designed to reward those who use it with digital immediacy, born sustainable and contemporary.

RULE BREAKER

Eclectic, pioneering, innovative, capable of elevating every experience and endowed with a unique personality.



EXPERIMENTATION DOES NOT ALLOW LIMITS: THE PIONEERS OF TASTE DREAM TODAY ABOUT THE RECIPES AND INGREDIENTS OF TOMORROW.

E1 PRIMA EXP LIBERATES CREATIVITY AND EXALTS EVERY INGREDIENT TO CREATE SO MANY RECIPES AND COCKTAILS BASED ON ESPRESSO, PURE BREW AND MILK.

WELCOME TO PUREBREW

The best in organoleptic fragrance, the trend that has conquered the world: a pure brew coffee offers an experience of absolute taste.

The excellence of extraction that characterises every Victoria Arduino machine comes with the rule-breaking heart of E1 Prima EXP, bringing the purity and intensity of filter coffee into every setting and opening the way to experimentation of every ingredient, every preparation and every specialty.

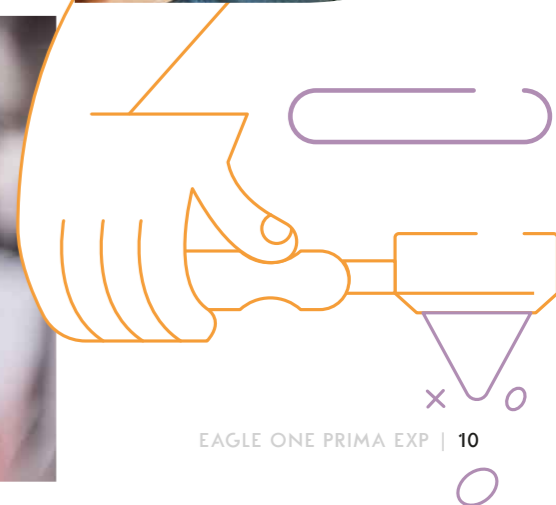



PURE BREW TECHNOLOGY

Pure brew, the purest taste

PureBrew is a new coffee extraction method without the pressure of a traditional espresso machine. This technology, new patented conical double-mesh filter, offers the enjoyment of a filter coffee with unique and distinctive characteristics compared to other methods of filter extraction.

From the E1 Prima EXP and from the app it is possible to pass quickly and simply from espresso to PureBrew mode. With the help of this new technology baristas with limited experience can immediately offer an excellent quality filter coffee (Pure Brew), whilst those who are more experienced can set the machine to extract the best flavours for one or more coffees.

Every variable is under control

After setting the basic parameters (dosage, volume, temperature and total brewing time), less than three minutes is all that is needed to obtain the purest filter coffee. Depending on the chosen coffee, several profiles (light, medium and dark) are available for the extraction. And once programmed, PureBrew will maintain absolute consistency, one coffee after another.

THE THREE PHASES OF EXTRACTION

PureBrew Technology

Every organoleptic characteristic of the filter coffee can be kept by simply applying the three phases of PureBrew extraction.

BLOOMING

To keep the maximum coffee aroma and not to wash it away before infusion, the grounded coffee needs to be prepared. PureBrew performs blooming dispensing the proper amount of water according to the coffee with low-frequency and low-intensity

POUR 1

Relatively low pressure is fundamental for preserving the oils and fragrances of the coffee. When you want perfection, there's no room for too much or too little.

POUR 2

Reducing the frequency of the water minimises the likelihood of extracting negative compounds that could give the coffee woody or astringent tones. Post-infusion control is the last check to achieve the perfect brewing.

Only the energy that is necessary, immediately and we you need it.

NEW ENGINE OPTIMIZATION



The NEO (New Engine Optimization) engine represents a new approach to water heating for coffee extraction with reduced energy use.

With this technology, E1 Prima EXP can heat the water quickly and can guarantee high performance results, whilst increasing energy efficiency.

The boilers are compact, insulated and coated with an innovative material that prevents energy loss.

The procedure is efficient, as well as being simple and intuitive. Just set the temperature from the app.

The machine's electronic system does the rest, maintaining a stable temperature during the whole dispensing process.



EFFICIENT STEAM IN LESS TIME

Unlike other machines in the category that have manual steam taps, E1 Prima EXP is equipped with an electronic tap. The **Steam-by-Wire** system provides more control over steam dispensing with a pressure of up to 2.5 bar (the standard level is 2.1) and a very high power/speed ratio. The machine is therefore able to guarantee elevated production of high-quality dry and saturated steam, useful for fast

creation of an excellent milk froth. A pressure of 2 bar, for example, enables 250g of milk (the equivalent of two cappuccinos) to be heated in less than 18 seconds. This high productivity combines with good temperature stability, even after very short time periods.

FROTH MILK AUTOMATICALLY WITH EASYCREAM

Easycream technology permits automatic frothing of milk and plant-based drinks at the right temperature and with the correct dose of milk froth. Just press the steam lever to get the correct dose of frothed milk for cappuccinos, flatwhites and lots of other drinks.

Easycream technology can be easily set from the app: just select the final temperature of the milk and the air temperature, while the double Easycream wand automatically heats up the milk and injects air, creating the perfect foam.

The **Easycream** system makes it possible to create a lot of recipes in the app to be able to enjoy cappuccino, flatwhite, milk and many other dairy milk and plant-based drinks.



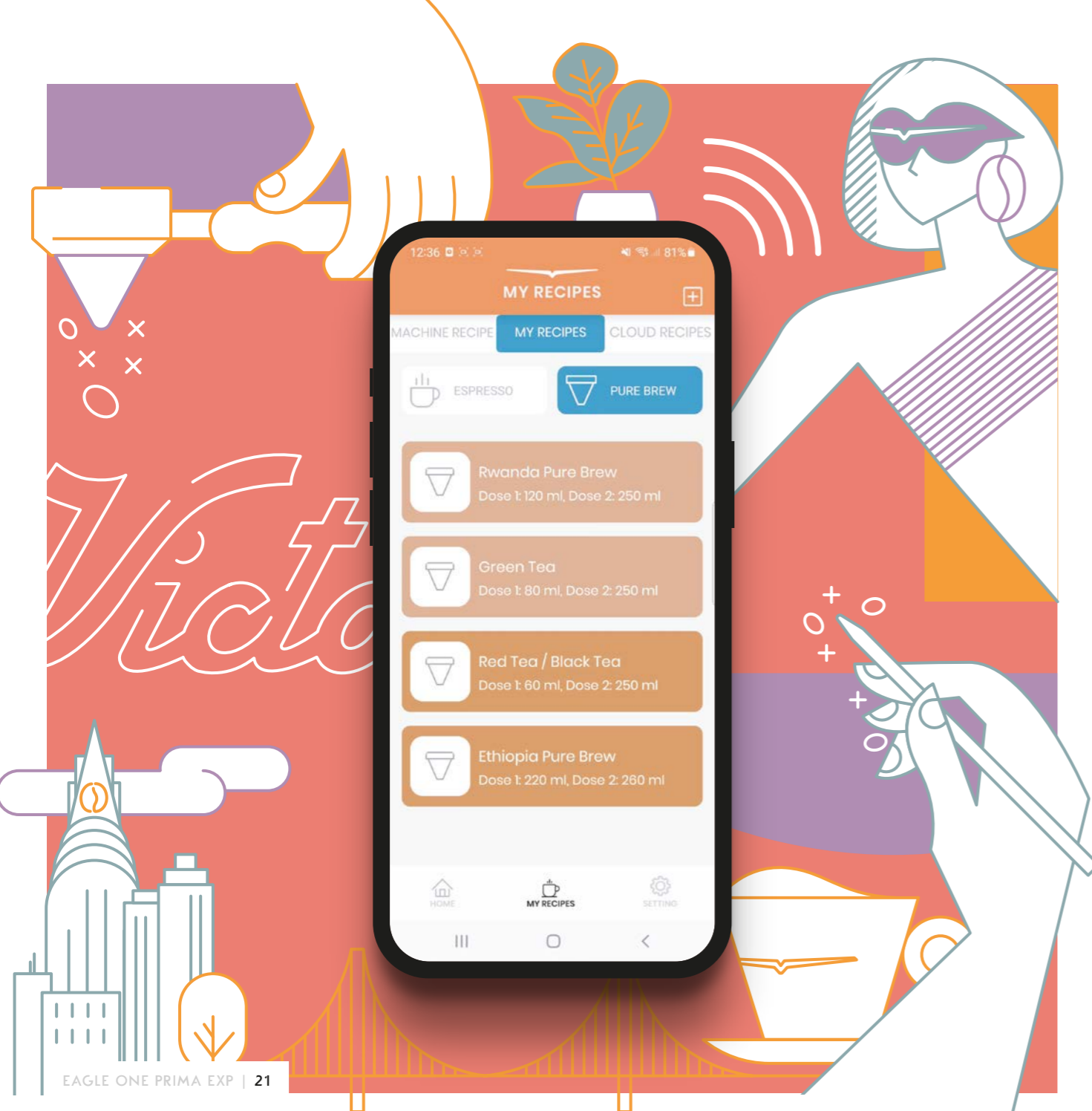

Settings, use,
programming:
all in an app

A DIGITAL MACHINE

Everything is even easier, just like using an app. Anyone who purchases E1 Prima EXP, immediately has access to an app linked to the machine that makes it possible to optimise performance and use.

In fact, from the app, **the temperature can be set and extraction time can be seen. It is also possible to check the performance of the machine.** All the functions of a professional machine at your fingertips with a simple and intuitive app.

E1 Prima EXP is an espresso machine that **takes full advantage of the digital revolution and is in constant dialogue with the user.**

With the app, it is possible to create your own recipes, share them or set onto the machine the ones offered by your own trusted roastery or by your barista.

The app can become a tool for **sharing recipes** in the 'Cloud Recipe' section of the Victoria Arduino App.

Wi-Fi Connection

E1 Prima EXP was created to be connected for reading wifi data. It's a really versatile tool for keeping performance and function under control.



COMPACT AND SUSTAINABLE



Among the features of E1 Prima EXP there are also its compact dimension and the choice of materials with high thermal efficiency. The design, the applied technologies, the solutions for reducing waste and the insulation of the components contribute to cutting environmental impact, which make E1 Prima EXP a sustainable machine.

- heating in just 8 minutes
- heating optimisation with PID
- less than 18 seconds to heat the milk for two cappuccinos
- insulated boilers for heat loss reduction
- compact boilers for instantaneous heating of just the needed quantity of water
- switching on/off programming from the app
- autopurge (automatic cleaning of group) settable from app to guarantee group cleaning, using the right quantity of the water.



LESS IS MORE



STEAM MODULE:

- Power: 1600 W
- Material: stainless steel
- Range: 0.8 – 2.5 bar (recommended: 2.1 bar)
- Electronic steam control
- Volumetric pump: 50litres/h

DISPENSING MODULE

- Range: 80-105°C

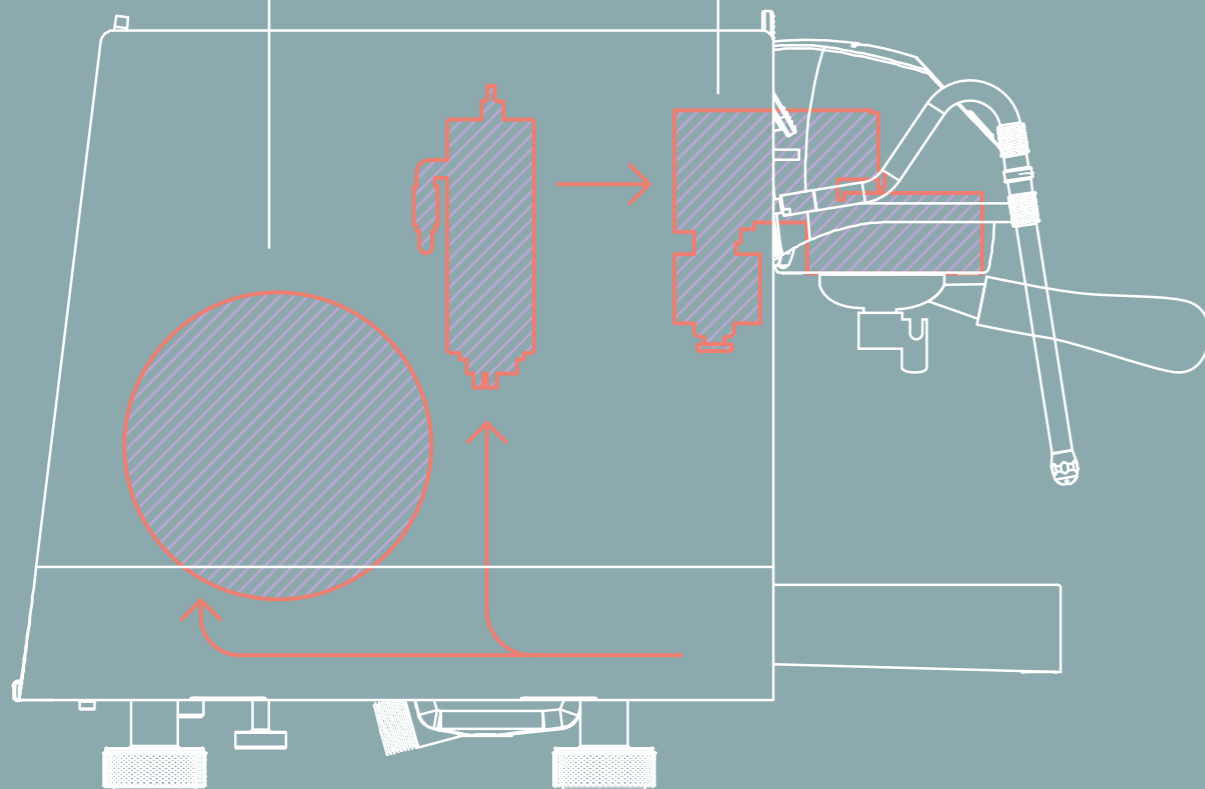

MATERIALS

The boilers are made of steel and are coated in an **innovative insulated material** that guarantees very efficient thermal insulation and prevents heat loss.

ELECTRONIC STEAM CONTROL

Energy efficiency is also provided by the electronic steam control **(Steam-by-Wire)**, that enables **greater control over steam dispensing** and a very high power/speed ratio.

ENERGY OPTIMIZATION

The new motor with **NEO (New Engine Optimisation)** technology provides immediate high-level performance by reducing energy consumption and substantially cutting waiting times for heating. Unlike other professional machines in its category, E1 Prima EXP requires less than 8 minutes to be ready and fully operational.

LOW ENVIRONMENTAL IMPACT

The compact and insulated boilers need to heat smaller volumes of water, thereby reducing heat loss, without affecting performance. At the same time, there is a reduction in energy consumption.

EJ PRIMA EXP

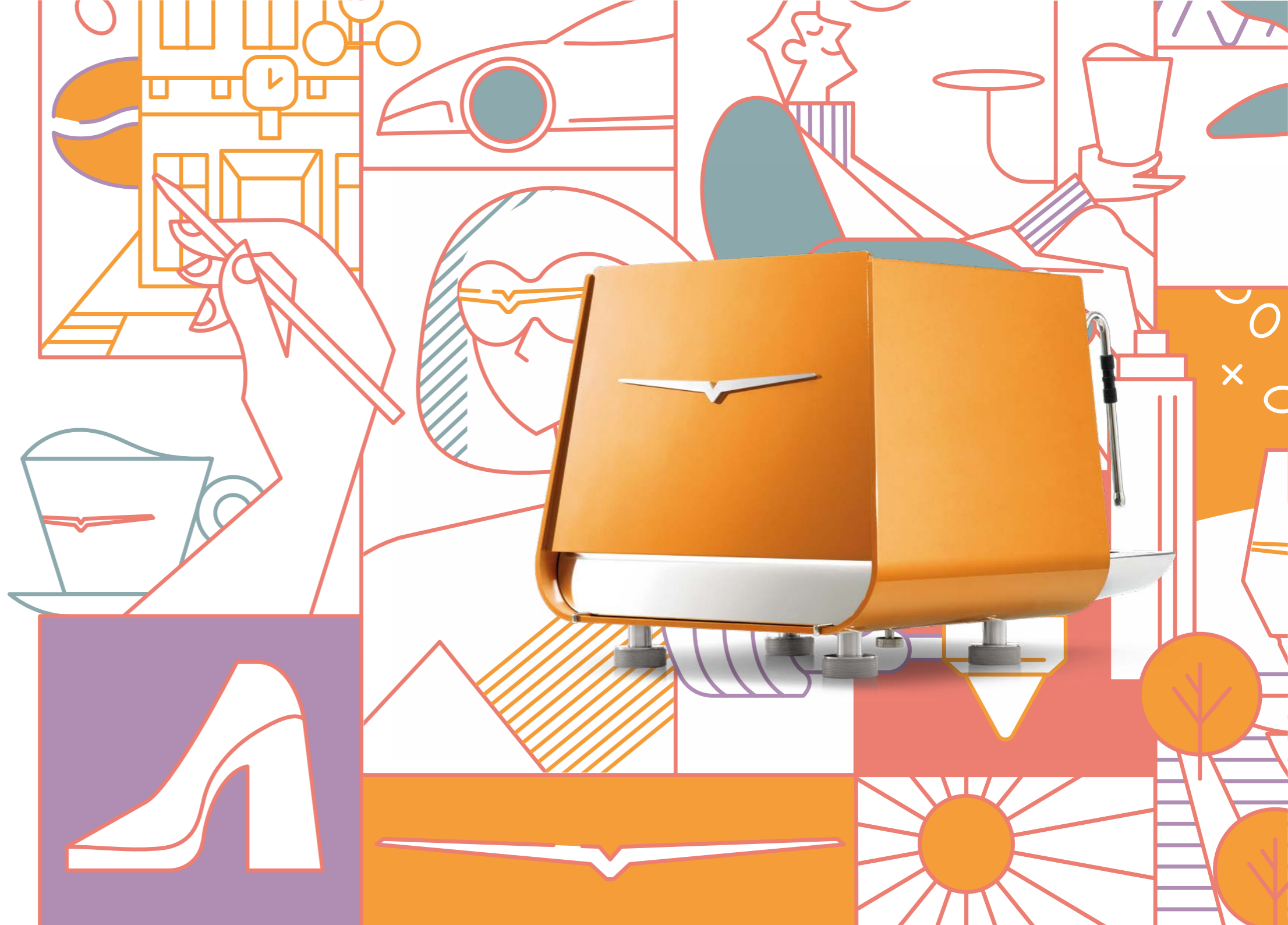

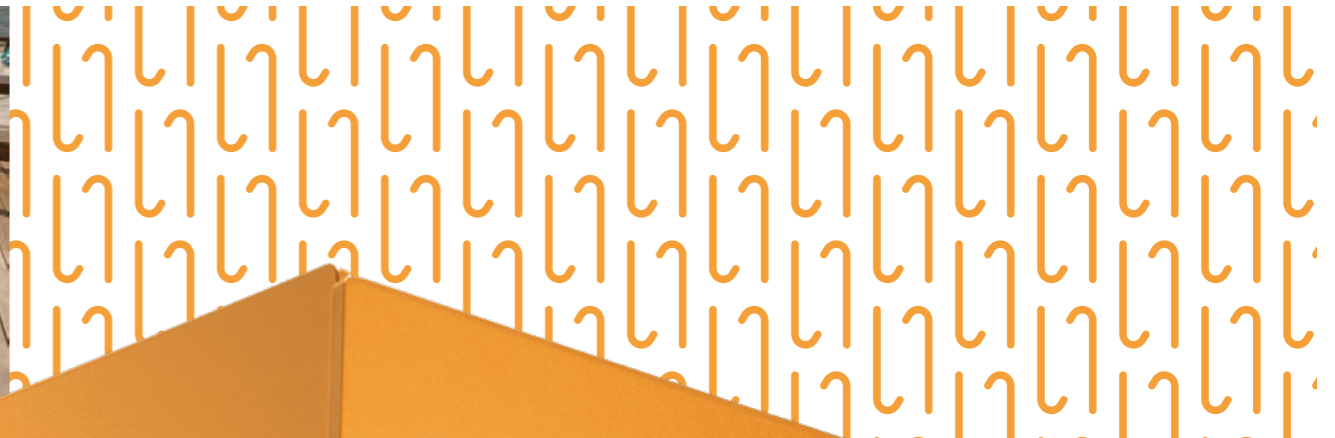

DESIGN AND SIMPLICITY

Minimal, made in Italy, refined: E1 Prima EXP stands out not only for its **exceptionally pure and simple lines**, but also because it adapts perfectly to different atmospheres and settings.

The design, combined with technological innovation, makes a strong impact on the forms and the organisation of the internal components. **The result is an object that is extremely compact, ergonomic, slender and elegant.**

An object that doesn't go unnoticed.

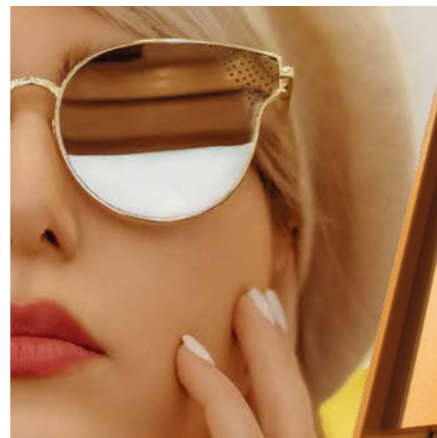

COLOUR PALETTE

Born from design,
surrounded
by beauty.

Our DNA consists of technical excellence and aesthetic wonder. A design that combines compactness and ergonomics with sculpted curves and lines in the wake of Victoria Arduino tradition and beauty. The colours of E1 Prima EXP are inspired by modernity, to fit into the spaces it inhabits with personality and fluidity.



DETAILS AND OPTIONS THAT MAKE THE DIFFERENCE

Available with tank and direct connection

Two versions in one to offer an excellent coffee experience wherever and whenever you want.

Group cover

Simplification of the group control panel with three buttons and the addition of a LED that inform about heating and water level, keeping the barista in control.

Cool Touch steam wand (standard equipment)

The Cool Touch wand avoids the risk of burns and simplifies cleaning.

Exclusive steam wand design

A unique design that offers countless possibilities: the steam wand allows you to use jugs of different sizes and a dedicated purge space for simplifying cleaning and avoiding possible burns.

Easycream (optional)

The solution that enables you over time to repeat the same milk froth automatically, simply and quickly.

Ghost display

The display is perfectly integrated into the machine group cover. It activates when dispensing starts and then disappears into the design of the group cover.

EASYCREAM



GHOST DISPLAY



GROUP COVER



COOLTOUCH STEAM WAND



MEASUREMENTS

TECHNICAL SHEET

Details

Rear and interior lights	Included
Tank or direct connection	Included
Autopurge	Included
Economizer	Included
Cool touch	Included
Boiler insulation	Included
Pure brew filter holder	Included
Stainless steel filter holder	Included
Stainless steel pavillon	Included
Showerhead reinforced	Included
EasyCream	Optional
Raised feet	Optional

Dimensions

Width	411mm
Depth	510mm
Height	379mm
Cupwarmer	330 x 280mm
Group height	95mm
Power	min 1000/max 2600W

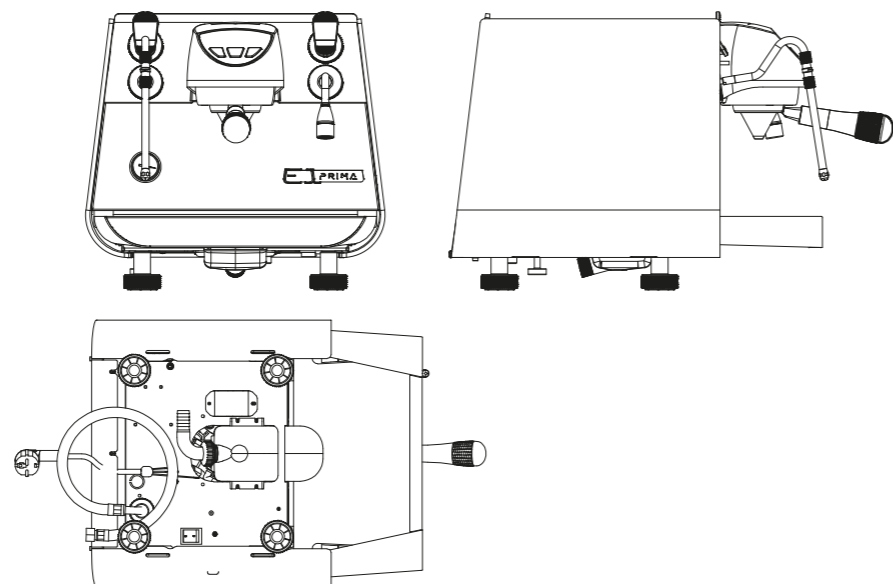

RECIPES

PURE BREW COFFEE



- Dose in: 19gr
- Dose out: 240gr
- PureBrew Profile: Medium
- Temperature: 90°C

PURE BREW GREEN TEA



- Dose in: 2.5gr
- Dose out: 120ml
- PureBrew Profile: Light
- Temperature: 75°C

PURE BREW COFFEE



- Dose in: 2.5gr
- Dose out: 120ml
- PureBrew Profile: Medium
- Temperature: 85°C

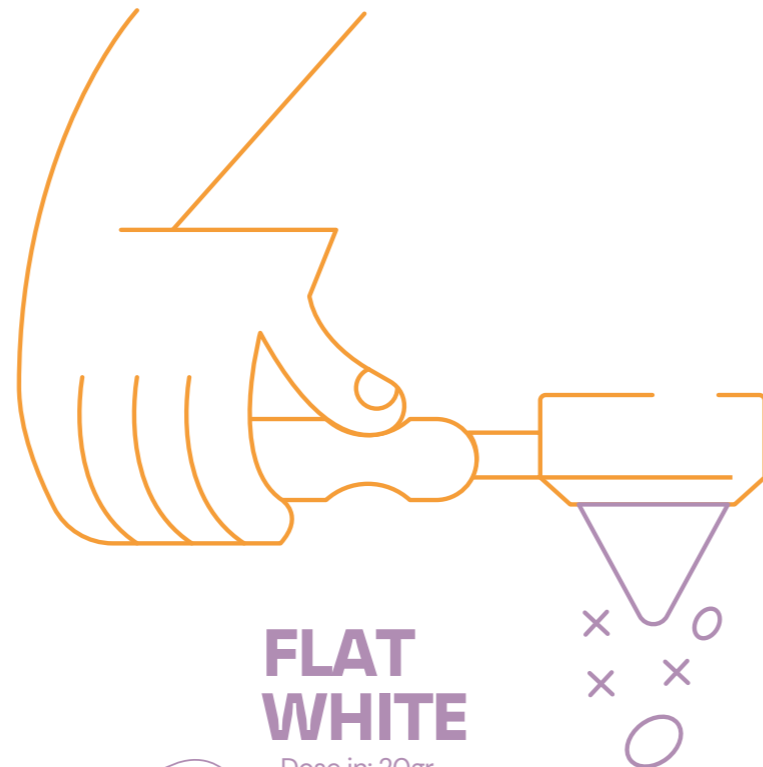

FLAT WHITE



- Dose in: 20gr
- Dose out: 36gr
- Temperature: 92°C
- Milk quantity: 120 ml of very thin frothed milk
- Milk temperature: 60°C

ESPRESSO



- Dose in: 20gr
- Dose out: 42gr
- Temperature: 90°C

'PRIMA ON FLOWER' COCKTAIL



- 10 ml rose syrup
- 20 ml elder flower syrup
- 10 ml jasmine syrup
- 20 ml vodka
- 80 ml of PureBrewCoffee
- Dose in: 19gr
- Dose out: 240gr
- PureBrew Profile: Medium
- Temperature: 90°C
- Suggested type of coffee: natural or fermented
- 10 ml fresh lemon
- Lavander spray

'THE PRIMA-RY DRINK' COCKTAIL



- 10 ml vanilla syrup
- 20 cl alpine bitter
- 30 ml vermouth
- 6 cl cl PureBrewCoffee
- Dose in: 19gr
- Dose out: 240gr
- PureBrew Profile: Medium
- Temperature: 90°C
- Suggested type of coffee: natural or fermented
- Chinotto

EL PRIMA EXP



Victoria Arduino
INSPIRED BY YOUR PASSION.

EAGLE PRIMA EXP



Victoria Arduino
INSPIRED BY YOUR PASSION.

victoriaarduino.com/eagleoneprima