

Operating Instructions

Countertop Coffee Machine



To prevent accidents and machine damage, you absolutely **must** read these instructions before installation or use.

Packaging material / Disposal of old machine

Packaging material

The packaging material used protects the machine during transportation. Please retain the original box and polystyrene pieces so that you can pack the appliance securely, should you need to transport it in the future.

Disposal of your old appliance

Electrical and electronic appliances contain valuable materials. They also contain certain substances, compounds and components which were essential for the proper functioning and safe use of the equipment. Handling these materials improperly by disposing of them in your household waste can be harmful to your health and the environment. Therefore, please do not dispose of your old appliance with regular household waste and follow local regulations on proper disposal.



Consult with local authorities, dealers or Miele in order to dispose of and recycle electrical and electronic appliances. Miele assumes no responsibility for deleting any personal data left on the appliance being disposed. Please ensure that your old appliance is kept away from children until removal. Observe safety requirements for appliances that may tip over or pose an entrapment hazard.

Packaging material / Disposal of old machine	2
IMPORTANT SAFETY INSTRUCTIONS	6
Guide to the appliance	16
Controls and display	17
Accessories	18
Operation	19
Before first use	20
Before using for the first time	20
Turning on for the first time	20
Water hardness	22
Filling the water tank	23
Filling the coffee bean container	24
Switching on and off	25
Adjusting the coffee dispensers to the cup height	26
Preparing beverages	27
Making a coffee drink.....	27
Cancelling a drink.....	28
Double portion.....	28
Coffee pot: Making several cups of coffee one after the other.....	29
Making coffee drinks from ground coffee	29
Adding ground coffee.....	29
Dispensing hot water (CM5400, CM5500)	30
Making drinks using a profile (CM5400, CM5500)	31
Making coffee with milk	32
Using milk cartons or bottles	32
Preparing drinks with milk	33
Grinder setting	34
Amount of coffee, brew temperature, and pre-brewing	35
Amount of coffee	35
Brewing temperature	35
Pre-brewing ground coffee.....	35

Contents

Portion size	36
User profiles	38
Accessing user profiles	38
Creating a user profile	38
Selecting a user profile.....	39
Changing a user profile	39
Changing the name.....	39
Deleting a user profile.....	39
Settings	40
Accessing the “Settings” menu.....	40
Changing and saving settings.....	40
Setting options	41
Language.....	42
Timer: switch off after.....	42
Eco mode	42
Info (displaying information)	42
Locking the coffee machine (System lock )	42
Water hardness	43
Display brightness.....	43
Volume.....	43
Factory default setting.....	43
Showroom program (Demo mode).....	43
Cleaning and care	44
Overview of cleaning intervals.....	44
Unsuitable cleaning agents	45
Clean by hand or in dishwasher	46
Grounds container, drip tray, and drip tray cover	47
Cleaning the water container	48
Main dispenser with integrated Cappuccinatore.....	48
Milk pipework	50
Bean container and ground coffee chute.....	50
Cleaning the housing.....	51
Care programs.....	51
Accessing the “Maintenance” menu	51
Rinsing the appliance	52
Rinsing the milk pipework	52
Degreasing the brew unit and cleaning inside	54
Descaling the appliance	57

Transport	59
Evaporating the coffee machine.....	59
Packaging.....	59
Frequently Asked Questions	60
Messages in the display	60
Unusual performance of the coffee system	63
Unsatisfactory results.....	70
Technical Service	72
Contact in case of fault	72
Warranty	72
Saving energy	73
Electrical connection	74
Installation	75
Appliance dimensions	76
Technical data	77

IMPORTANT SAFETY INSTRUCTIONS

Please read these instructions carefully to prevent accidents and appliance damage.

This appliance complies with current safety requirements. Improper use of the appliance can cause personal injury and material damage. Read this safety information carefully before operating the appliance.

They contain important information on the safe installation, operation, and care of your coffee system. To avoid the risk of personal injury or damage to the coffee system, it is important that you carefully read the instructions. Miele cannot be held liable for damage caused by non-compliance with these **IMPORTANT SAFETY INSTRUCTIONS**.

Keep these instructions in a safe place and pass them on to any future user.

IMPORTANT SAFETY INSTRUCTIONS

Intended use

- ▶ Use this coffee system only in standard household environments for making coffee beverages such as espresso, cappuccino, latte macchiato, etc. Any other type of use is not permitted.
- ▶ The coffee system is not suitable for outdoor use.
- ▶ This coffee machine must not be used at altitudes above 6560 ft (2000 m).
- ▶ The machine is intended only for the preparation of coffee-based drinks such as espresso, cappuccino, latte macchiato etc. Any other usage is not supported.
- ▶ Persons which lack physical, sensory or mental abilities or experience with the machine should not use it without supervision or instruction by a responsible person.

IMPORTANT SAFETY INSTRUCTIONS

Safety with children

 Caution! Danger of burning and scalding on the dispensing dispensers.

Children's skin is far more sensitive to high temperatures than that of adults.

Ensure children do not touch hot surfaces of the coffee system or place parts of their body under the dispensing dispensers.

- ▶ Keep the coffee system out of reach of children.
- ▶ Keep children away from the appliance, the power cord and outlet.
- ▶ Children should be supervised when they are near the coffee system. Do not allow them to play with it or to use the controls.
- ▶ Remember that coffee and espresso are not suitable drinks for children.
- ▶ Danger of suffocation!
Keep children away from any packing material.

IMPORTANT SAFETY INSTRUCTIONS

Technical safety

- ▶ Before installing the coffee system, check for externally visible damage. If the coffee system is damaged, it may pose a safety hazard and must not be used under any circumstances.
- ▶ Before connecting the coffee system, check the voltage and frequency indicated on the data plate against the voltage and frequency of the household electrical supply.
This data must correspond in order to prevent damage to the coffee system. If in doubt, consult a qualified electrician.
- ▶ Be certain your appliance is properly installed and grounded by a qualified technician. To guarantee the electrical safety of this appliance, continuity must exist between the appliance and an effective grounding system. It is imperative that this basic safety requirement be met. If there is any doubt, have the electrical system of the house checked by a qualified electrician.
- ▶ Reliable and safe operation of the coffee system can only be guaranteed if it is connected to the electrical supply.
- ▶ Do not connect the machine to the electrical supply using an extension cord or power bar.
- ▶ The coffee machine may not be used in mobile installations such as ships.
- ▶ Unplug the coffee machine from the power supply immediately if you notice any damage or smell scorching, for example.
- ▶ Do not operate any appliance with a damaged cord or plug or after the appliance malfunctions, or has been damaged in any manner. Return appliance to the nearest authorized service facility for examination, repair or adjustment.
- ▶ Ensure that the power cord will not be pinched or damaged by any sharp edges.

IMPORTANT SAFETY INSTRUCTIONS

- ▶ The power cord should not hang down. Someone could trip over it with the risk of injury and the appliance could be damaged.
- ▶ Do not let cord hang over edge of table or counter, or touch hot surfaces.
- ▶ Do not place on or near a hot gas or electric burner, or in a heated oven.
- ▶ Only use the coffee system in rooms where the ambient temperature is between +50°F (10°C) and +100°F (38°C).
- ▶ Danger of overheating! Ensure that there is sufficient ventilation around the coffee system. Do not cover it with tea towels etc. while it is in use.
- ▶ If the coffee system is installed behind a cabinet door, it may only be used with the door open. This will prevent the formation of heat and humidity and subsequent damage to the appliance and/or housing unit. Do not close the cabinet door while the coffee system is in use. Ensure the coffee system has cooled down completely before closing the door.
- ▶ Protect the coffee system from water and water spray. Do not immerse the appliance in water.
- ▶ Repairs and other work by unqualified persons to the appliance and the power cord could be dangerous. The manufacturer cannot be held liable for unauthorized work. Repairs may only be carried out by a Miele-authorized service technician.
- ▶ The manufacturer's warranty will be invalidated if the appliance is not repaired by a Miele approved service technician from Technical Service.
- ▶ Miele can only guarantee the safety of the appliance when genuine Miele parts are used. Faulty components must only be replaced by Miele original parts.

IMPORTANT SAFETY INSTRUCTIONS

▶ For repairs, the coffee system must be disconnected from the electrical power supply.

The coffee system is only disconnected from the power supply if

- The power cord has been unplugged.
Unplug the cord by pulling on the plug, not on the cord.
- The fuses to the household power supply are turned off.
- Any screw-in fuses in the household supply are fully unscrewed.

▶ Never open the outer casing of the machine. Tampering with electrical connections or components and mechanical parts is highly dangerous to the user and can cause operational faults or electric shock.

▶ To protect against fire, electric shock and injury to persons do not immerse cord, plugs, or coffee machine in water or other liquid.

▶ Disconnect the coffee system from the power supply if it is not going to be used for some time.

▶ Use only genuine original Miele parts. If parts or accessories from other manufacturers are used, the warranty may become void. The use of accessory attachments not recommended by Miele may result in fire, electric shock or injury to persons.

IMPORTANT SAFETY INSTRUCTIONS

Proper use

 Danger of burning and scalding at the dispensers. The liquids and steam dispensed are very hot.

Keep away from the area underneath the dispensers when hot liquids and steam are being dispensed.

Do not touch hot components.

Hot liquid or steam could spatter from the spouts. Ensure that the main dispenser is clean and fitted correctly.

Water in the drip tray can also be very hot. Take care when emptying it.

▶ Please note the following regarding water:

- Only use cold, fresh tap water to fill the water container. Hot or warm water or other liquids can damage the coffee machine.
- Change the water every day to prevent a build-up of bacteria.
- Do not use sparkling water.

▶ Only fill the bean container with roasted espresso or coffee beans. Do not fill the bean container with coffee beans that have been treated with additives or with ground coffee.

▶ Do not pour liquids into the bean container.

▶ Do not use green (unroasted) coffee beans or mixtures of coffee beans which contain green coffee beans. Green coffee beans are very hard and still contain residual moisture. These can damage the coffee machine grinder as soon as grinding begins.

▶ Do not use oily beans or beans that have been treated with caramel, sugar, or other substances. Sugar and oil will damage the coffee system.

▶ Only fill the coffee chute with ground coffee beans.

IMPORTANT SAFETY INSTRUCTIONS

- ▶ Do not use any flavored ground coffee. The sugar in the coffee will stick to and block the brew unit of the coffee system. The cleaning tablets for degreasing the brew unit will not remove this type of deposit.
- ▶ Only use plain milk. Most sugary additives can clog the milk lines and damage the machine.
- ▶ If using dairy milk make sure that it has been pasteurized.
- ▶ Do not place any alcohol mixtures which are alight underneath the main dispenser. The flames could ignite plastic components and cause them to melt.
- ▶ Do not use open flames, such as a candle, on or near the coffee machine. The coffee machine could catch fire with the risk of the fire spreading.
- ▶ Do not use the coffee system to clean objects.

IMPORTANT SAFETY INSTRUCTIONS

Cleaning and care

- ▶ The coffee system must be disconnected from the electrical supply before cleaning or maintenance. Allow to cool before putting or taking off parts, and before cleaning or maintenance.
- ▶ Clean the coffee machine daily, particularly before using for the first time (see “Cleaning and care”).
- ▶ All parts of the milk system need to be cleaned thoroughly and regularly.
- ▶ Do not use a steam cleaner to clean this machine. Steam could reach electrical components and cause a short circuit.
- ▶ Descale the coffee system regularly depending on the water hardness level in your area. Descale the machine more frequently in areas with very hard water. Miele cannot be held liable for damage arising from insufficient descaling, the use of incorrect descaling agent or the use of descaling agent that is not of the appropriate concentration.
- ▶ Degrease the brew unit regularly with Miele cleaning tablets. Depending on the natural oil content of the coffee used, the brew unit can become blocked quite quickly.
- ▶ Rinsing coffee grounds down the drain can cause the sink to clog. Instead, dispose of your coffee grounds appropriately as biodegradable waste (where facilities exist) or by composting.

IMPORTANT SAFETY INSTRUCTIONS

For machines with stainless steel surfaces:

- ▶ Do not use sticky notes, transparent adhesive tape, masking tape, or other types of adhesive on the stainless steel surfaces.
- ▶ Stainless-steel surfaces are susceptible to scratching. Even magnets can cause scratches.

SAVE THESE INSTRUCTIONS



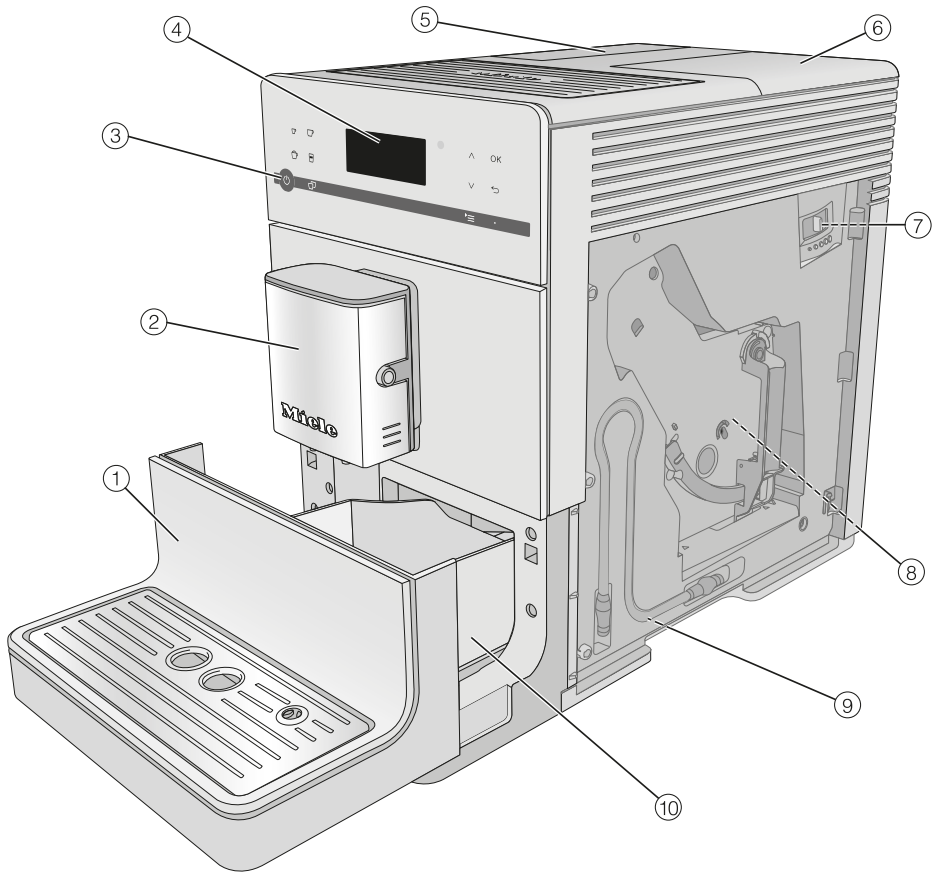





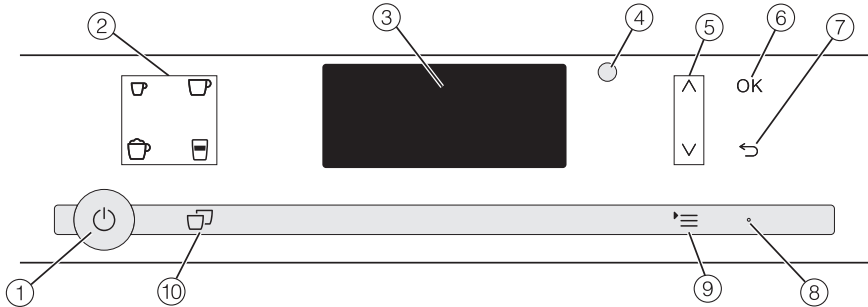

Guide to the appliance



- ① Lower panel with drip tray cover
- ② Main dispenser with Cappuccinatore and hot water dispenser
- ③ On/Off button 
- ④ Controls and display
- ⑤ Water container
- ⑥ Bean container and ground coffee chute
- ⑦ Grinder setting (behind the service panel)
- ⑧ Brew unit (behind the service panel)
- ⑨ Park position for milk pipework (behind the service panel)
- ⑩ Drip tray with lid and grounds container

Controls and display



- ① **On/Off button** 
For turning the appliance on and off
- ② **Drink buttons**
For making espresso ,
coffee ,
cappuccino  or
latte macchiato 
- ③ **Display**
Shows information on current activity
or status
- ④ **Optical interface**
(for Miele Technical Service only)
- ⑤ **Arrow buttons**  
For showing additional selection
options in the display and
highlighting a selection
- ⑥ **OK**
For confirming display messages and
saving settings
- ⑦ **Back** 
For returning to the previous menu,
canceling unwanted actions
- ⑧ **LED**
Flashes when the appliance is
switched on and the display is in
energy saving mode
- ⑨ **Menus** 
Additional drinks
Profiles*
Maintenance
Parameters
Settings 
- ⑩ **Double portion** 
For preparing two portions of a drink

* CM5400, CM5500

Accessories

These products and other useful accessories can be ordered via the Miele Webstore, from Miele Service or from your Miele dealer.

Included accessories

- **Miele “Welcome Pack”**
Different cleaning products are supplied depending on model.
- **Cleaning brush**
for cleaning the milk pipework, for example.

Optional accessories

Miele also offers a range of optional accessories, as well as cleaning and conditioning products for your coffee system.

- **Microfiber cloth**
for removing finger marks and light soiling
- **Cleaning agent for milk pipework**
for cleaning the milk system
- **Cleaning tablets**
for degreasing the brew unit
- **Descaling tablets**
for descaling the water pipework
- **Stainless steel milk flask MB-CM**
For keeping milk cool longer
(capacity approx. 2 cups / 0.5 l)
- **CJ JUG coffee pot**
Coffee pot for coffee or tea
(capacity 1 l)

To operate the coffee machine, tap the sensor buttons with your finger.

An audible signal is generated each time a button is touched. You can adjust the volume of the signal tones or switch the tones off (see “Settings – Volume”).

When the following appears on the display, you are in the drinks menu:

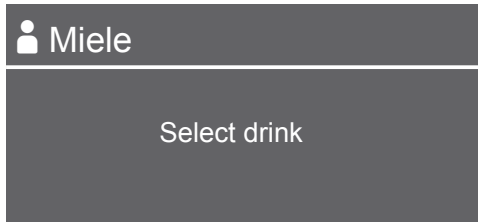

To make a coffee drink, tap one of the drink buttons.

Touch  to open the Additional drinks menu. This includes drinks such as Ristretto and Caffè Latte.

Selecting a menu and navigating within a menu

To select a menu, tap the relevant button. You will then be able to start an action or change settings in the menu.

A scroll bar at the right of the display shows that additional options or text are available. Use the arrow keys \wedge / \vee to display them.

The setting which is currently selected will have a checkmark \checkmark beside it.

To select an option, touch the arrow buttons \wedge / \vee until the option/menu item you want is highlighted.

To confirm the selection, tap *OK*.

Leaving the menu or canceling an action

To exit the current menu, tap \leftarrow .

Before first use

Before using for the first time

- Remove any protective coverings and notices from the machine.

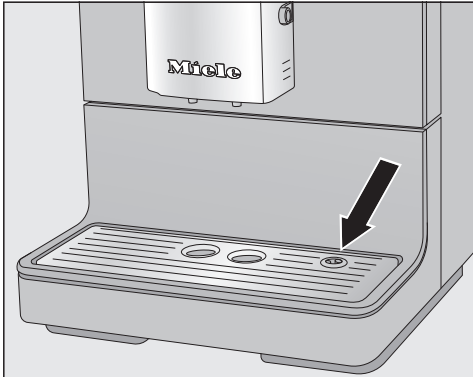

- Remove the protective foil from the drip tray cover and place the drip tray cover into the lower panel.
- Place the coffee machine on a level flat surface that is not sensitive to water (see “Installation”).

Clean the appliance thoroughly before filling it with water and coffee beans.

- Insert the plug of the coffee machine into the socket.
- Remove the water container and fill it with fresh, cold tap water. Only fill the container up to the “max.” mark and then reinsert the water container.
- Take the lid off the coffee bean container, fill it with roasted coffee beans and replace the lid.

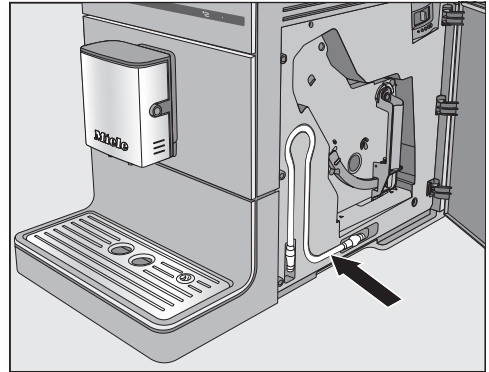

Tip: The milk pipework can be stored behind the service panel when not in use.

Turning on for the first time

- Tap the On/Off button .

Miele - Willkommen appears briefly on the display.

- Use the arrow buttons \wedge \vee to highlight the required language. Then tap OK.
- Select the country if necessary and then tap OK.

The setting is saved.

The coffee machine is now successfully set up for use. The coffee machine will heat up and rinse the pipework. Rinse water flows out of the main dispenser.

- Rinse the milk pipework (see “Rinsing the milk pipework”) before making a drink with milk for the first time.

Please note that the coffee aroma and the characteristic crema only develops after the first few coffees have been made.

A larger quantity of coffee beans is ground for the first coffee drinks and powder from the coffee grounds may adhere to the cover of the drip tray.

Water hardness

The water hardness level indicates how much calcium is dissolved in the water. The higher the calcium content, the harder the water, and the harder the water, the more often the coffee machine will need to be descaled.

The coffee machine measures the amount of water used and steam made. Depending on the level of water hardness set, more or fewer drinks can be dispensed before the appliance needs to be descaled.

Program the coffee machine to the water hardness level of your area so that it functions correctly and does not get damaged. At the correct time a prompt will then appear in the display to descale the appliance.

Your local water authority will be able to tell you the hardness of water in your area.





The water hardness level is set to 3 at the factory.

You can program four hardness levels on the machine:

°dH	gr/gal	Setting
0 - 8.4	0 – 8.7	Soft 1
8.4 – 14	8.7 - 14.6	Medium 2
14 – 21	14.6 - 21.9	Hard 3
> 21	> 21.9	Very hard 4

* The water hardness settings in the display may differ from the water hardness level in your area. To set the correct water hardness level for your area **always** refer to the values in the chart.

Setting the water hardness

- Tap .
- Select the Settings  menu with the arrow buttons   and tap *OK*.
- Select *Water hardness* and tap *OK*.
- Select the hardness level you want and then tap *OK*.

The setting is saved.

Filling the water tank

⚠ Change the water **every day** to prevent a build-up of bacteria.

Only use cold, fresh tap water to fill the water container.

Hot or warm water or other liquids can damage the coffee machine.

Do not pour carbonated water into the water container.

If the water container sits a little too high or at an angle, check that it is fitted correctly or whether the surface that it sits on is soiled. Water could leak. If necessary clean the surface that the water container sits on.



- Open the lid on the left-hand side of the coffee machine.
- Pull the water container upwards and out.
- Fill the water container with fresh, cold tap water up to the “max.” mark.
- Replace the water container and close the lid.

Make sure that the water container handle is on the right so that the lid can close properly.

Filling the coffee bean container

Coffee or espresso can be made from whole roasted coffee beans which are freshly ground for each portion. This requires the coffee bean container to be filled with coffee beans.

Alternatively, you can make coffee or espresso with ground coffee (see “Making coffee drinks from ground coffee”).

Warning! Risk of damage to the grinder.

Only put roasted coffee beans in the bean container. Do not fill the bean container with ground coffee.

Do not fill the bean container with any type of liquid.

Warning! Sugar will damage the coffee machine.

Do not use coffee beans that have been treated with sugar, caramel, or other substances and do not put liquids containing sugar in the coffee bean container.

Do not use green (unroasted) coffee beans or mixtures of coffee beans which contain green coffee beans. Green coffee beans are very hard and still contain residual moisture. These can damage the coffee machine grinder as soon as grinding begins.

Tip: You can use a nut or seed grinder to grind green coffee beans. These types of grinder generally have a rotating stainless-steel blade. You can then add the ground green coffee **one portion at a time** to the ground coffee chute and make the desired coffee drink (see “Making coffee drinks using ground coffee”).

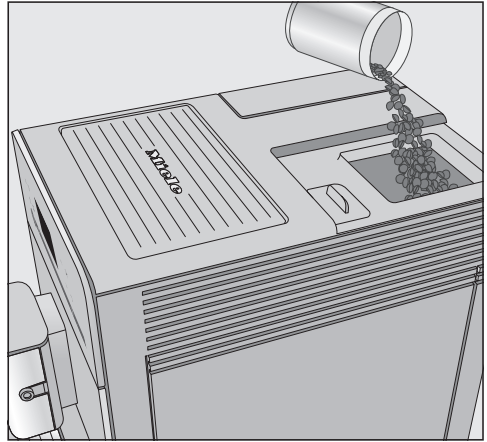

- Take the lid off the coffee bean container.
- Fill the bean container with roasted coffee beans.
- Replace the lid.

Switching the coffee machine on

- Tap the On/Off button .

The appliance heats up and rinses the pipework. Hot water will run out of the main dispenser.

When *Select drink* appears on the display, you can make drinks.

If the coffee machine is already at operating temperature, rinsing will not take place when the appliance is switched on.

If no buttons are touched or maintenance programs carried out, the display will turn off after approx. 7 minutes to save energy. The LED on the right flashes as long as the machine is switched on.

- Tap any one of the sensor buttons to wake the appliance up again to make a drink.

Switching the coffee machine off

- Tap the On/Off button .

After a coffee drink has been dispensed, the pipework will be rinsed before the appliance turns off.

If you have made a drink using milk, Place milk pipe in drip tray will appear in the display.

- Insert the end of the milk pipe into the aperture in the drip tray, and then tap *OK*.

If the milk system is not rinsed out before turning off, it will have to be rinsed the next time the appliance is turned on.

Turning off for longer periods of time

If the coffee machine is not going to be used for a longer period of time, for example, if you are going on vacation:

- Empty the drip tray, the waste unit, and the water container.
- Clean all parts thoroughly, including the brew unit.
- Switch off the machine and unplug the power cord to disconnect it from the power supply.

Adjusting the coffee dispensers to the cup height

You can adjust the main dispenser to suit the height of the cup you are using so that the coffee or espresso will not cool down as quickly and the crema will have a better consistency.

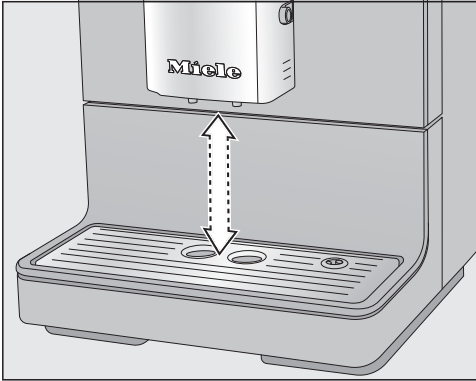

- Pull the main dispenser down until it is at the same level as the rim of the cup.

Alternatively, push the main dispenser up until there is enough room to fit a larger cup or mug underneath.

Preparing beverages

The following drinks without milk can be made:

- **Ristretto** ☐ is a concentrated, strong espresso. The same quantity of coffee powder as for an espresso is prepared with very little water.
- **Espresso** ☐ is a strong, aromatic coffee with a thick hazelnut-brown cream layer – the crema – on top. Use espresso-roasted coffee beans for preparing espresso.
- **Coffee** ☐ differs from espresso by the increased amount of water and the roast of the beans. Use coffee beans of the correct roast to make coffee.
- **Lungo** is a coffee with significantly more water.

⚠ Danger of burning and scalding from the dispensers.

The liquids and steam dispensed are very hot.

Keep away from the area underneath the dispensers when hot liquids and steam are being dispensed.

Do not touch hot components.

Making a coffee drink



- Place a cup under the main dispenser.
- Select a drink:
 - Espresso ☐
 - Coffee ☐
 - Go to *Additional drinks* under '≡' for: Ristretto or lungo

Dispensing will start.

To ensure that any coffee residues from the factory testing process are removed from the brewing system, please throw away the first two cups of coffee when using the coffee machine for the first time.

Preparing beverages

Canceling a drink

- To cancel making a drink, tap the drinks sensor or \equiv for drinks from *Additional drinks* again.

Drink preparation will be canceled.

Tip: You can also cancel making a drink by tapping *OK* as soon as *Stop* appears in the display.

When making **coffee with milk** or a **double portion of a drink** you can cancel each stage individually by tapping *OK*.

Double portion

You can dispense two portions into one cup or dispense two portions into two cups at the same time.



- To fill two cups at the same time, place a cup under each coffee spout.
- Tap \square .
- Select a drink.

Two portions of the desired drink will be dispensed from the main dispenser.

If, after a while, you have not tapped one of the drink buttons, the “Double portion” \square option will revert back to single portions.

Coffee pot: Making several cups of coffee one after the other

You can make several cups of coffee one after the other automatically with the Coffee pot function (max. 0.75 liter) to fill a coffee pot, for example. Up to six cups can be made in this way.

You can use the Coffee pot function twice in a row. After this, the coffee machine needs to cool down for one hour in order to prevent it from being damaged.

- Place a sufficiently large container under the main dispenser.
- Tap **'≡**.
- Select Additional drinks.
- Touch the arrow buttons **^** repeatedly until Coffee pot is highlighted. Tap **OK**.
- Use the arrow buttons **^**/**v** to highlight the desired number of cups (3 to 6). Then tap **OK**.
- Follow the instructions given in the display.

Each portion of coffee will be ground, brewed, and dispensed individually. You can follow the process in the display.

Canceling Coffee pot

- Tap **'≡**.

Coffee pot dispensing will stop.

Tip: A stainless steel coffee pot is available as an optional accessory from Miele for the "Coffee pot" function. The CJ JUG coffee pot is available to order from the Miele online shop, from Miele Technical Service, or from your Miele dealer.

Making coffee drinks from ground coffee

To make drinks using ready-ground coffee, add a portion of ground coffee to the ground coffee chute.

This allows you to make a decaffeinated coffee even if the bean container is already filled with regular coffee beans, for example.

Only **one** portion of coffee or espresso can be prepared at a time when using ground coffee.

Place a **maximum of 0.4 oz (12 g)** in the ground coffee chute. If too much is added, the brew unit will not be able to process the coffee.

Adding ground coffee

The coffee machine will use all the ground coffee that has been added to the chute to make the next coffee.

- Tap **'≡** and select Additional drinks.
- Use the arrow buttons **^**/**v** to select Ground coffee and tap **OK**.

Add ground coffee and select drink will appear in the display.

Preparing beverages

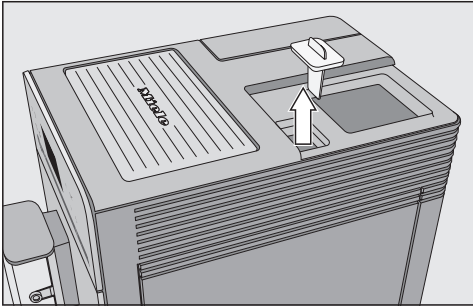

- First take the lid off of the coffee bean container and then take the cover off the ground coffee chute.

Place a **maximum of 0.4 oz (12 g)** in the ground coffee chute.

- Replace the cover to the ground coffee chute after adding the ground coffee.
- Replace the lid on the coffee bean container.
- Place a cup under the main dispenser.
- Select a drink.

The coffee will now be made.

Dispensing hot water (CM5400, CM5500)

 Caution! Danger of burning and scalding on the main dispenser. Water coming out of the dispenser is very hot.

Please note that the water dispensed is not hot enough for making black tea.

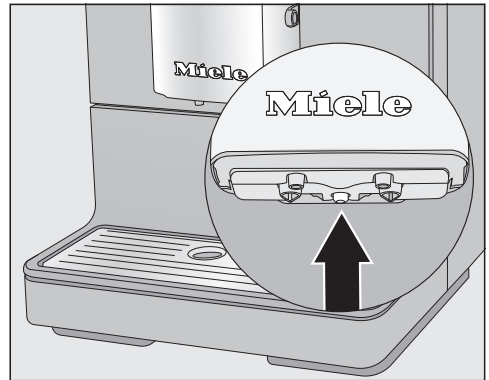

- Place a suitable container centrally underneath the main dispenser.
- Tap  and select *Additional drinks*.
- Select *Hot water* and tap *OK*.

Hot water will run into the container under the main dispenser.

- To stop dispensing early, touch *OK*.

Making drinks using a profile (CM5400, CM5500)

You can tailor drinks to your personal preferences and save them in a profile.

If you have already created your own profile (see “User Profiles”), you can select this to make a drink according to your own taste.

- Tap  and select Profiles.
- Select the profile you want and tap *OK*.

The name of the selected user profile will appear in the top of the display.

You can now make your drink.

Making coffee with milk

⚠ Caution! Danger of burning and scalding from the main dispenser. Liquids and steam dispensed will be very hot.

Only use plain milk. Most sugary additives can clog the milk lines, and damage the appliance.

As soon as you select a drink containing milk the appliance will start to heat up. The milk will be drawn up into the central spout where it is heated by steam and also frothed for drinks requiring milk froth.

If you have not made any milk drinks for a while, rinse the milk system thoroughly before making the first drink to ensure any bacteria is flushed out.

The following drinks with milk can be made:

- **Cappuccino** ☕ consists of approx. 2/3 milk froth and 1/3 espresso.
- **Latte macchiato** ☕ consists of 1/3 each of hot milk, milk froth and espresso.
- **Caffè latte** consists of hot milk and espresso.

Hot milk and **milk froth** can also be made.

Tip: Using cold milk (< 50°F/10°C) will produce the perfect milk froth. You can select milk with a fat content according to preference. With whole milk (at least 3.5% fat), the milk froth will be slightly creamier.

Using milk cartons or bottles

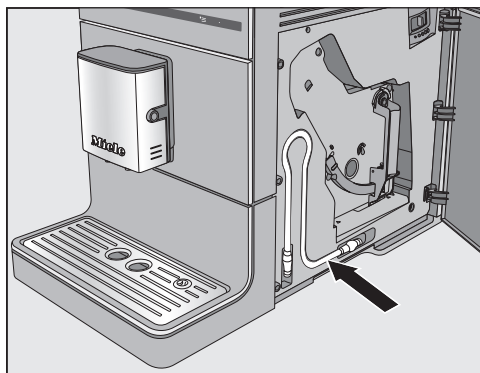

The milk pipe for cartons and other suitable containers is located behind the service panel.

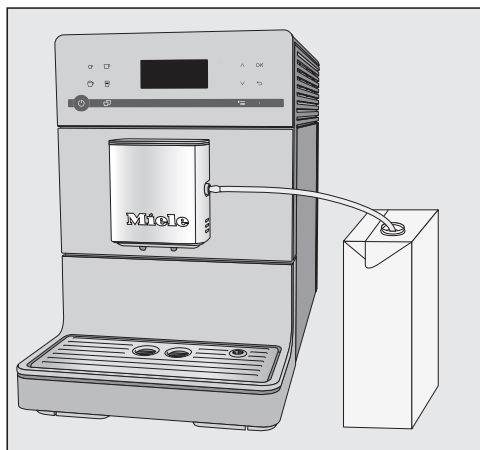

- Connect the milk pipe to the aperture in the main dispenser.
- Place a container with sufficient milk beside the coffee machine.

- Place the end of the milk pipe in the container. Make sure that it is sufficiently immersed in the milk.

Tip: The Miele stainless-steel flask keeps milk cool for longer, as good milk froth can only be made with cold milk (< 50°F (10°C)).

The MB-CM milk flask is available to order from the Miele online shop, from Miele Technical Service, or from your Miele dealer.

Preparing drinks with milk

- Place a suitable container under the main dispenser.
- Select a drink:
 - Cappuccino ☞
 - Latte macchiato ☐
 - Go to *Additional drinks* in the ☰ menu to select:
 - Caffè latte, Hot milk, and Milk froth

The drink will now be made.

Grinder setting

When the beans are ground correctly, the coffee or espresso will flow evenly into the cup with a good crema. The crema should have an even nutbrown colour.

The grinder setting you select will be used for all coffee drinks.

There are various ways to tell whether the coffee grinder is set correctly.

The coffee is ground **too coarse**, if

- espresso or coffee flows into the cup too quickly.
- the crema is very pale and uneven.

Set a finer grinder setting.

The coffee is ground **too fine**, if

- espresso or coffee flows into the cup very slowly.
- the crema is dark brown.

Set a coarser grinder setting.

To avoid damaging the grinder, please note the following:
Only adjust the grinder one setting at a time.
Grind the coffee beans again if you want to adjust the grinder to the next setting.

- Open the service panel.

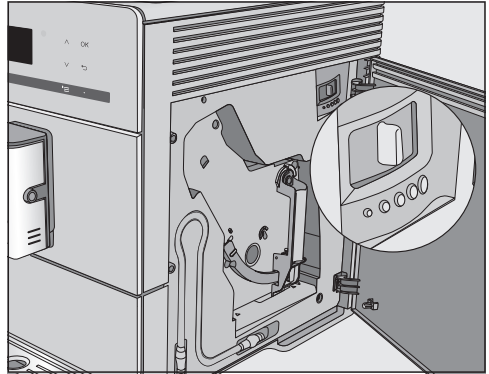

- Push the slide control one setting to the left (for finer grinding) or one setting to the right (for coarser grinding).
- Close the service panel.
- Make one cup of coffee.

After this, you can adjust the grinder setting again.

The altered grinder setting will not be used until after the second coffee has been dispensed.

Amount of coffee, brew temperature, and pre-brewing

You can set the amount of coffee, the brewing temperature, and pre-brewing for each drink individually. To do this, first select the drink from the Parameters menu and then adjust the drink parameters.

- Tap '☰ and select Parameters.
- Select the drink you want and tap OK.

The current settings for the amount of coffee, brewing temperature, and pre-brewing will be displayed for this drink.

- Select Amount of coffee, Brew temperature, or Pre-brewing.
- Select the setting you want and tap OK.

The setting is saved.

Amount of coffee

The coffee machine can grind and brew 6–14 g of coffee beans per cup. The greater the quantity, the stronger the coffee.

There are various ways to tell whether the amount of coffee is set correctly:

The amount of coffee is **too low** if

- espresso or coffee flows into the cup too quickly,
- the crema is very pale and uneven,
- the espresso or coffee lacks body.

Increase the amount of coffee so that more ground coffee is brewed.

The amount of coffee is **too high**, if

- espresso or coffee flows into the cup very slowly,

- the crema is dark brown,
- the espresso or coffee tastes bitter.

Decrease the amount of coffee so that less ground coffee is brewed.

Tip: If the coffee is too strong for you or it tastes bitter, try a different type of bean.

Brewing temperature

The ideal brewing temperature will depend on

- the type of coffee being used,
- whether an espresso or a coffee is being prepared, and
- the altitude of the region.

Tip: Not all types of coffee tolerate high temperatures. Several types are sensitive to high temperatures, resulting in an impaired crema and taste.

Pre-brewing ground coffee

When the pre-brewing function is turned on, the freshly ground coffee is first moistened with a little hot water. Then the remaining water is forced through the moistened coffee at high pressure. This helps release the flavor of the coffee.

You can set pre-brewing for a normal length of time or an extra long length of time. Alternatively, you can turn off the “Pre-brewing” function.

The machine is supplied with the “Pre-brewing” function turned off.

Portion size

The flavor of the coffee produced depends not only on the type of coffee, but also on the amount of water used. You can program the amount of water for all coffee drinks and hot water to suit the size of your cups and the type of coffee you are using. This does not alter the amount of coffee used.

For coffee drinks that use milk you can also set the amount of milk or milk froth to be dispensed with these drinks, as well as the amount of coffee or espresso. Additionally, you can set the portion sizes for hot milk and milk froth alone.

A maximum portion size can be programmed for each type of drink. Dispensing stops once this has been reached. The maximum possible portion size is then saved by the appliance for this type of drink.

If the water container becomes empty while making a drink, the machine will stop programming the portion size. The portion size will **not** be saved.

There are two ways of initiating the programming of the portion size:

- by touching the drink button when you are making a coffee, or
- by selecting **Portion size** in the **Parameters** menu.

CM5400, CM5500: The changed portion size is always saved in the current profile. The name of the current user profile is shown at the top left of the display.

Cancelling portion size programming

- Tap the drinks button or '≡ for drinks from **Additional drinks** again.

Changing the portion size while making a drink

You can change and save the portion size for espresso ☐, coffee ☐, cappuccino ☐, and latte macchiato ☐ while making these drinks.

- Place a cup under the main dispenser.
- Tap the sensor button for the desired drink until **Change** appears in the display.

An audible tone will sound as soon as portion size programming starts. (As long as the volume has been set for the audible tones – see “Volume”.)

The desired drink will be made and **Save** will appear in the display.

- When the container is filled to the desired level, tap **OK**.

If you want to change the portion size for coffee with milk, the ingredients of the drink are saved one after the other during preparation.

- When the quantity for each ingredient reaches the desired level, tap **OK**.

The programmed mix of ingredients and portion sizes will now be dispensed every time that particular drink is selected.

Changing the portion sizes in the Parameters menu

You can only change the portion sizes for **lungo**, **caffè latte**, **hot milk**, and **milk froth** via the “Parameters” menu.

- Place a suitable container under the main dispenser.
- Tap  and select Parameters.
- Select the drink you want.
- Select Portion size and tap *OK*.

Now proceed as for changing the portion size while making a drink.

User profiles

(CM5400, CM5500)

If the coffee machine is used by several people with different tastes and coffee preferences, you can create individual user profiles in addition to the Miele profile.

In each user profile, you can adjust the settings for individual drinks (portion size, amount of coffee, brewing temperature, and pre-brewing).

The name of the current user profile is shown at the top left of the display.



Accessing user profiles

- Tap  and select Profiles.



You can now create a user profile.

If you have already created a profile in addition to the Miele profile, you have the following options:



- **Select profile** from the user profiles that have already been allocated.
- **Change profile** to program the coffee machine so that it changes back to the Miele standard profile automatically after each drink is dispensed or so that it retains the most recently selected profile.
- **Change name** if you want to alter the name of a user profile.
- **Delete profile** if you want to delete a user profile.

Tapping  takes you back to the previous menu. Tapping  takes you back to the drinks menu.

Creating a user profile

- Use the arrow buttons   to select **Create profile** and tap **OK**.

Letters will appear in the display that you can select with the arrow buttons. You can use the arrow buttons to select from numbers, upper case and lower case letters.



- Tap arrow buttons   to select the character and then tap **OK**.

The character will then appear in the line above.

- Repeat the process until the desired name appears in the display line above.

Tip: You can delete the last character entered by tapping .

When you have finished entering a name and want to save it,

- use the arrow keys   to highlight the check  and tap **OK**.

If you do not want to save what you have entered,

- tap and hold  until all characters have been deleted and the coffee system jumps back to the previous menu.

The last created profile is selected as the current profile.

Selecting a user profile

This selection is only possible if a profile has been allocated in addition to the Miele standard user profile.

- Use the arrow buttons \wedge \vee to select **Select profile** and tap **OK**.
- Select the profile with the arrow buttons \wedge \vee and tap **OK**.

The name of the current user profile is shown at the top left of the display.

Changing a user profile

You can program the coffee system so that it changes back to the Miele standard profile automatically after each drink is dispensed, so that the Miele profile is always active when the appliance is switched on or so that it retains the most recently selected profile.

- Select **Change profile** and tap **OK**.

You now have the following options:

- **Manually:** The selected user profile remains active until you select another user profile.
 - **After each use:** The appliance will change back to the Miele standard user profile automatically after a drink is dispensed.
 - **When turned on:** Each time the appliance is switched on it will automatically select the Miele standard user profile regardless of which user profile was set before the appliance was last switched off.
- Select the required option and tap **OK**.

Changing the name

This selection is only possible if a profile has been allocated in addition to the Miele standard user profile.

- Use the arrow buttons \wedge \vee to select **Change name** and tap **OK**.
- Proceed the same as with “**Create profile**”:
 - Select \leftarrow to delete a character.
 - To enter new characters, highlight the relevant character and confirm with **OK**,
 - Save the new name by selecting \checkmark in the display and tapping **OK**.

Deleting a user profile

This selection is only possible if a user profile has been allocated in addition to the Miele standard user profile.

- Use the arrow buttons \wedge \vee to select **Delete profile** and tap **OK**.
- Select the profile you wish to delete.
- Select **Yes** and then tap **OK**.

The profile will be deleted.

Settings

Accessing the “Settings” menu

- Tap '≡.
- Select *Settings* with the ^ arrow key and then tap *OK*.

You can now check or change the settings.

The check ✓ next to the individual entry shows you which setting is currently active.

Tapping ↶ takes you back to the previous menu.
Tap '≡ if you want to go back to the *Select drink* menu.

Changing and saving settings



The *Settings* menu is displayed.

- Select the setting you wish to change with the arrow buttons ^∇.
Tap *OK*.
- Tap the arrow buttons ^∇ until the option you want is highlighted.
Tap *OK*.

The setting is saved.

Setting options

The factory default for each option is indicated by *.

Menu item	Available settings
Language 	German*, English and other languages Country
Timer	Turn off after (0:30)*
Eco mode	On* / Off
Info	Number of drinks – Total coffee drinks / Total no. of uses / Espresso / Coffee / Cappuccino / Latte macchiato / Ristretto / Coffee Americano / Caffè latte / Hot milk / Milk froth / Hot water (CM5400, CM5500 only) No. of uses until – Descale the appliance / Degrease the brew unit
System lock 	On / Off*
Water hardness	Soft Medium Hard* Very hard
Display brightness	Set the brightness
Volume	Buzzer tones Keypad tone
Showroom program	Demo mode (On / Off*)
Factory default	Do not reset Reset

Settings

Language

You can select the language (and country variant of that language) for all display text.

Tip: If you select the wrong language by mistake, you can find the “Language” option by following the flag symbol .

Timer: switch off after

If none of the keys have been pressed or no drink has been prepared, the coffee machine will turn itself off after 30 minutes to save energy.

You can change this pre-setting using the arrow buttons ∇/\wedge to a time between 15 minutes and 9 hours.

Eco mode

Eco mode is an energy-saving mode.

If Eco mode is switched on, the coffee machine will heat up anew every time a drink is made, so that making a drink takes longer.

If Eco mode is turned off, significantly more energy is used. The coffee machine heats up for the first drink preparation after being switched on. After that the appliance remains heated up and drinks can be prepared without having to wait very long.

The coffee machine will indicate that the energy consumption has been altered.

Info (displaying information)

Under the Info menu option, you can choose to display the number of portions made for each type of drink.

You can also see whether there are more than 50 portions before the next descaling or degreasing of the brew unit (No. of uses until).

Tip: To return to the previous display, tap *OK*.

Locking the coffee machine (System lock)

You can lock the coffee machine to prevent it from being used by unauthorized persons, such as children.

Activating and deactivating the system lock

When the system lock is activated, the timer settings for Turn on at are deactivated. The coffee system will **not** switch on at the time set.

Temporarily overriding the system lock

While the message Press and hold the *OK* button for 6 seconds to unlock is in the display,

■ tap *OK* for 6 seconds.

As soon as the coffee system is turned off, the system is locked again.

Water hardness

See “Water hardness” for more information.

Display brightness

Change the display brightness using the arrow keys \wedge \vee .

Volume

The volume of the alarm and the sensor buttons can be set using the arrow buttons \wedge \vee .

Tip: To switch off the tones, touch the arrow buttons \vee until no more segments are filled in and Turned off appears.

Factory default setting

You can reset the settings back to the ones which were set when the coffee system was delivered - the factory default settings.

The number of drinks and the appliance status (No. of drinks until ...) cannot be reset.

Please refer to the “Setting options” chart for the factory settings that are shown in bold.

The following settings will **not** be reset:

- Language
- Profiles and their drinks

Showroom program (Demo mode)

Do not activate this setting for domestic use.

The coffee system can be presented in Miele Showrooms of retail stores with the Showroom program function. The lighting will come on, but drinks cannot be dispensed and other actions cannot be carried out.

If you activate the Demo mode, you cannot turn the appliance off with the On / Off button ⏻ .

Cleaning and care



The coffee system must be cleaned regularly to prevent a build-up of bacteria.

Overview of cleaning intervals

Recommended frequency	What do I have to clean/maintain?
Daily (at the end of the day)	Water container
	Grounds container
	Drip tray and drip tray cover
Once a week (more often if heavily soiled)	Main dispenser with integrated Cappuccinatore
	Brew unit
	Area underneath the brew unit and the drip tray
	Housing (particularly important immediately after descaling the appliance)
	Milk pipework
Once a month	Bean container and ground coffee chute
When prompted	Degrease the brew unit (with 1 cleaning tablet)
	Descal the appliance (with 1 descaling tablet)

 Danger of burning and scalding on hot components or by hot liquids!
Always allow the coffee machine to cool down before cleaning it.
Caution: Water in the drip tray can be very hot.

 Do not use a steam cleaner to clean this machine. Steam could cause a short circuit.

It is important to clean the machine regularly as used coffee grounds go mouldy quickly. Milk residue can spoil and clog the milk pipework.

Unsuitable cleaning agents

All surfaces are susceptible to scratching. Scratches on glass can in some circumstances lead to breakage. Contact with unsuitable cleaning agents can discolor the external surfaces.

Ensure that any splashes of descaling solution are wiped up immediately.

Avoid spot cleaning with mechanical cleaning agents.

To avoid damaging the surfaces, do not use:

- cleaning agents containing soda, ammonia, acids, or chlorides
- solvent-based cleaning agents
- cleaning agents containing descaling agents (unsuitable for cleaning the housing)
- stainless-steel cleaning agents
- dishwasher cleaners (unsuitable for cleaning the housing)
- cleaning agents for ceramic cooktops
- oven cleaners
- abrasive cleaning agents, such as scouring powder, scouring liquid, or pumice stones
- hard, abrasive brushes or sponges, such as pot scourers or sponges which have been previously used with abrasive cleaning agents
- eraser sponges
- sharp metal scrapers

Cleaning and care

- steel wool or stainless-steel wire scourers

Glass cleaners may be used to clean the exterior. However do not allow them to sit or “puddle”, this can cause damage to the surface. **Remove the cleaner promptly.**

Clean by hand or in dishwasher

Please note that the brew unit is **not** dishwasher-safe.

Clean the brew unit by hand only under warm running water. **Do not use liquid dish soap or any other cleaning agent.**

Most of the parts that are **not** dishwasher-safe have a pictogram on them.



The following components must be cleaned **by hand only**:

- Stainless steel central spout cover
- Brew unit
- Bean container lid
- Lower panel

The following parts are **dishwasher-safe**:

The maximum temperature of the dishwashing program selected must not exceed 130°F (55°C).

Contact with natural dyes such as those found in carrots, tomatoes, and ketchup may discolor the plastic parts in the dishwasher. This discoloration does not affect the stability of the parts.

- Drip tray and lid
- Drip tray cover
- Waste unit
- Water container
- Main dispenser (without stainless steel cover)

Grounds container, drip tray, and drip tray cover

Clean the drip tray and grounds container **every day** to avoid unpleasant smells and mildew.

The grounds container is located in the drip tray. Water from rinsing also collects in the grounds container.

A prompt will appear in the display when the drip tray and/or the grounds container is full and needs to be emptied. Empty the drip tray **and** the grounds container.



Danger of burning!

If the rinsing process has just finished, wait a while before removing the drip tray from the appliance. The water used for rinsing will continue to run out of the coffee machine spouts for a while.

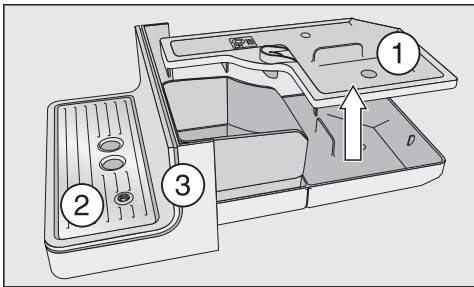

- Pull the drip tray carefully out of the coffee machine. Take the lid ① off.
- Empty the drip tray **and** grounds container.
- Remove the drip tray cover ② and the lower panel ③.
- Clean all parts thoroughly.

Clean the lower panel by hand only using warm water and liquid dish soap.

All other parts are dishwasher-safe.

- Clean the inside of the appliance underneath the drip tray.
- Reassemble all parts and place the drip tray back in the coffee machine.

Make sure the drip tray has been pushed into its niche as far as it will go.

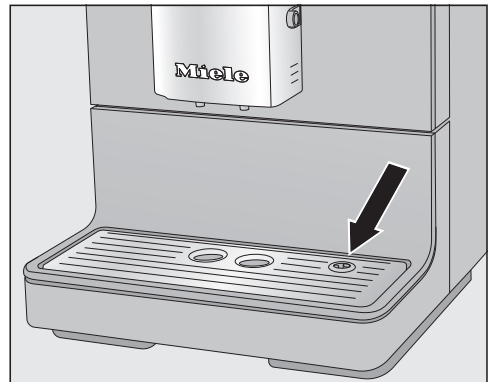

- Make sure that the drip tray cover is correctly fitted (see illustration).
- Clean the area under the coffee machine. Water can get under the appliance when the drip tray is removed.

Cleaning and care

Cleaning the water container

Change the water every day to prevent a build-up of bacteria.

Make sure that the valve, the underside of the water container, and the surface the water container sits on are clean. Otherwise, the water container will not sit correctly.

- Remove the water container.
- Clean the water container in the dishwasher or by hand using warm water and liquid dish soap. After cleaning, dry the water container.
- Carefully clean and dry the surface the water container sits on, particularly the recesses.
- Reinstall the water container.

Main dispenser with integrated Cappuccinatore

Clean the stainless-steel main dispenser cover **by hand only** using warm water and liquid dish soap.

All other parts are dishwasher-safe.

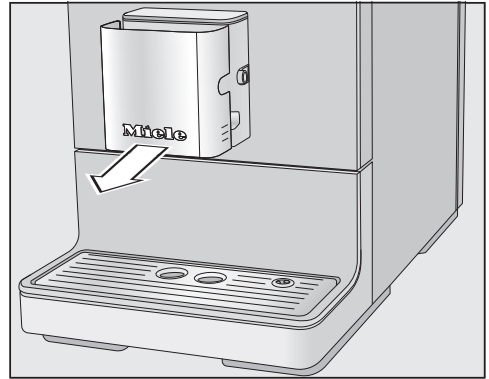

- Pull the stainless-steel cover forwards and off.

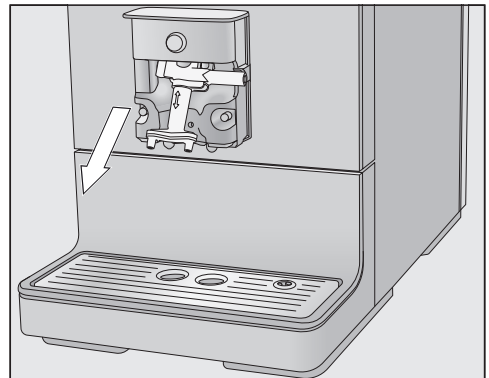

- Pull the dispensing unit down to remove it.

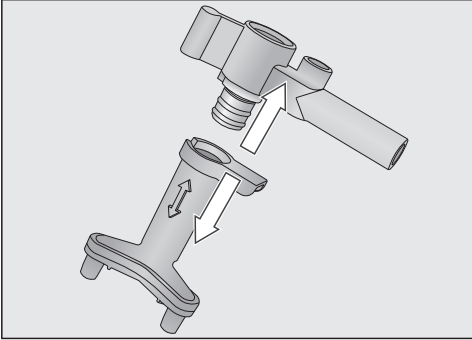

- Release the upper section with the holder for the milk pipework from the dispensing spouts.
- Clean all parts thoroughly.

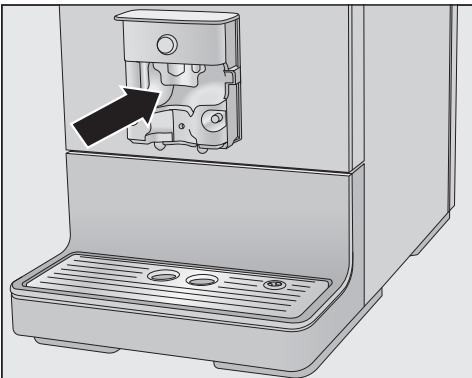

- Clean the surfaces of the main dispenser and the dispensing spouts with a damp cloth.

If the milk pipework is blocked, clean it under running water with the brush supplied:

- Insert the brush in the pipework. Move it back and forth until all milk residue has been removed.

Reassembling the main dispenser

The dispensing unit is easier to reassemble if the individual parts are dampened with water beforehand.

- Reassemble the dispensing unit.
- Refit the dispensing unit onto the main dispenser. Press firmly to ensure the dispensing unit is securely fitted without any gaps.
- Replace the stainless-steel cover and connect the milk pipe if applicable.

Cleaning and care

Milk pipework

 Ensure that all components in which milk is transported are cleaned carefully on a regular basis. Milk naturally contains bacteria that rapidly multiply if the milk pipework is not cleaned properly. Soiling in the appliance may be dangerous to health.

The milk pipework must be cleaned at least every 5 days.

There are two options for cleaning the milk pipework:

- You can remove and dismantle the main dispenser with its integrated Cappuccinatore and either wash it in the dishwasher or by hand with warm water and liquid dish soap (see “Main dispenser with integrated Cappuccinatore”).
- Or you can clean the milk pipework using the [Clean milk pipework maintenance program](#) together with a cleaning agent for milk pipework (see “Maintenance programs – Cleaning the milk pipework”).

Tip: In addition to your weekly cleaning routine, we recommend carrying out the alternative cleaning procedure once a month. For example, if you manually clean the machine once a week, then you should run the [Clean milk pipework maintenance program](#) once a month. This combination will ensure that the milk pipework is cleaned optimally.

Bean container and ground coffee chute

 Danger of injury from the grinder! Switch off the machine and remove the plug to disconnect the machine from the power supply before cleaning the bean container.

Coffee beans contain oils which can deposit on the walls of the bean container and hinder the flow of the beans. Therefore, clean the bean container regularly with a soft cloth.

- Open the bean container.
- Remove any coffee beans.
- Clean the bean container with a dry, soft cloth.

The coffee bean container can now be refilled.

If necessary, clean the ground coffee chute:

- Open the ground coffee chute and remove any ground coffee residue.

Tip: Use a vacuum cleaner to remove any coffee residues from the bean container and the ground coffee chute.

Cleaning the housing

Remove any soiling immediately. If soiling is not removed promptly, it could cause the surface to alter or discolor.

Make sure that water cannot get behind the display.

The surfaces are all susceptible to scratching and discoloration if unsuitable cleaning agents are used.

Ensure that any splashes of descaling solution are wiped up immediately.

- Switch the coffee machine off.
- Clean the front with a clean soft sponge and a solution of warm water and a little washing-up liquid. Dry all parts with a soft cloth.

Tip: You can also clean the housing with the Miele all-purpose microfiber cloth.

Care programs

The following maintenance programs are available:

- Rinsing the coffee system
- Rinsing the milk pipework
- Cleaning the milk pipework
- Degreasing the brew unit
- Descaling the machine

Perform the respective maintenance program when prompted to do so in the display. You will find more information in the following pages.

Accessing the “Maintenance” menu

- Tap .
- Select *Maintenance* and tap *OK*.

You can now select a maintenance program.

Cleaning and care

Rinsing the appliance

You can rinse the water and coffee pipework of the coffee machine manually.

If coffee has been dispensed, the coffee machine will rinse the coffee pipework automatically before switching off. This removes any residual coffee grounds.

- Tap ☰.
- Select Maintenance and tap *OK*.
- Select Rinse appliance and tap *OK*.

The pipework will be rinsed.

You may also be prompted to insert the end of the milk pipe into the drip tray.

Rinsing the milk pipework

Milk residues can block the milk pipework. The milk pipework should therefore be rinsed regularly. If a drink has been made using milk, the prompt to insert the end of the milk pipe into the drip tray will appear at the latest when you switch the machine off.

You can also rinse the milk pipework manually.

- Tap ☰.
- Select Maintenance and tap *OK*.
- Select Rinse milk pipework and tap *OK*.

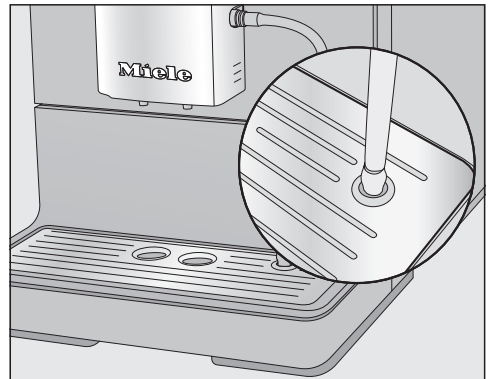

- When prompted, place the end of the milk pipe into the right-hand aperture in the drip tray.
- Tap *OK*.

The milk pipework will now be rinsed.

Cleaning the milk pipework with the maintenance program

For optimum cleaning results, we recommend the Miele Cleaning Agent for milk pipework. The Cleaning Agent for milk pipework has been specially developed for use with Miele coffee machines and prevents subsequent damage.

It is available to order from the Miele online shop, from Miele Technical Service, or from your Miele dealer.

The Clean milk pipework maintenance program lasts for approx. 5 minutes.

- Tap ☰.
- Select Maintenance and tap OK.

The cleaning process cannot be canceled. It must be completed through to the end.

- Select Clean milk pipework and tap OK.

The process will start.

- Follow the instructions on the display.

Place milk pipe in cleaning agent will appear in the display.

Making a cleaning solution:

- Dissolve the cleaning agent in a container with approx. 1 cup (200 ml) of lukewarm water. Stir the solution with a spoon until the powder has fully dissolved.

Carrying out the cleaning process:



- Place the container next to the machine and hang the milk pipe in the solution. Make sure that it is sufficiently immersed in the cleaning solution.
- Tap OK.
- Follow the additional instructions given in the display.

The cleaning process is complete when rinsing has finished.

Tip: Rinse any residual cleaning agent out of the milk pipework with running water.

Cleaning and care

Degreasing the brew unit and cleaning inside

Depending on the natural oil content of the coffee used, the brew unit can become blocked quite quickly. It must be degreased regularly in order to ensure aromatic coffee and trouble-free operation of the coffee machine.

For optimum cleaning we recommend Miele cleaning tablets. These cleaning tablets are specially designed for Miele built-in coffee machines and will protect your machine from subsequent damage.

They are available from the Miele Webstore, Miele Technical Service or from your Miele dealer.

The “Degrease brew unit” maintenance program lasts about 15 minutes.

After 200 portions have been dispensed, Degrease the brew unit and clean inside of the machine will appear in the display.

- Confirm the message with *OK*.

This notification appears at regular intervals. Once the maximum possible number of beverage preparations has been reached, the coffee machine is locked.

You can turn off the coffee machine if you do not want to carry out the cleaning program at this time. However, you will not be able to make any more drinks until the brew unit has been degreased.

Start “Degrease brew unit”

You need 1 cleaning tablet to degrease the brew unit.

- Tap \equiv .
- Select *Maintenance* and tap *OK*.
- Select *Degrease the brew unit*.

The cleaning process cannot be canceled. It must be completed through to the end.

- Tap *OK*.

The process will start.

- Follow the instructions on the display.

Cleaning the brew unit and interior

Clean the brew unit **by hand** only under warm running water. **Do not use liquid dish soap or any other cleaning agent.** The moving parts of the brew unit are lubricated. Cleaning agents will damage the brew unit. To ensure good tasting coffee and to prevent a build-up of bacteria in the machine, remove and clean the brew unit under running water once a week.

Rinse the brew unit by hand and clean inside the machine will appear in the display.

- Open the service panel.

Cleaning and care

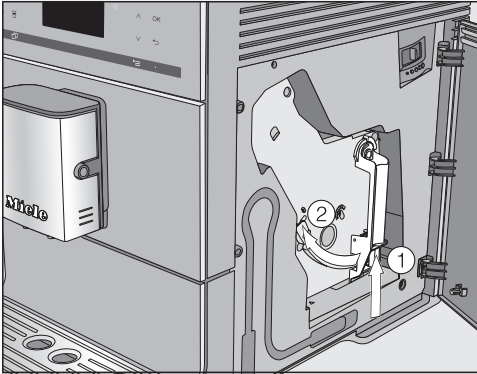

Make sure to remove moist ground coffee remnants regularly to prevent mold from forming.

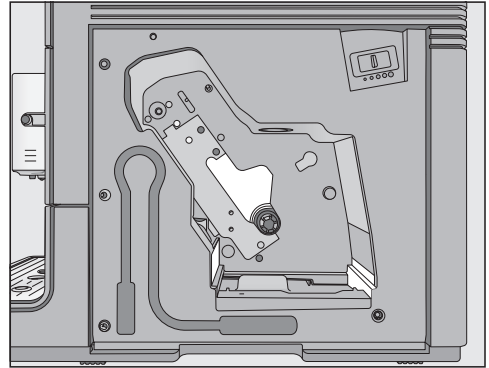

- Press and hold the button under the brew unit handle ① and, while doing so, turn the handle to the left ②.
- Carefully pull the brew unit out of the coffee machine.

When you have removed the brew unit, do **not** change the position of the handle on the brew unit.

- Clean the interior of the coffee machine. Make sure that the areas highlighted in the illustration are cleaned especially well.

Tip: Use your vacuum cleaner to remove dry coffee grounds.

- Clean the brew unit **by hand under warm running water** without using cleaning agent or liquid dish soap.

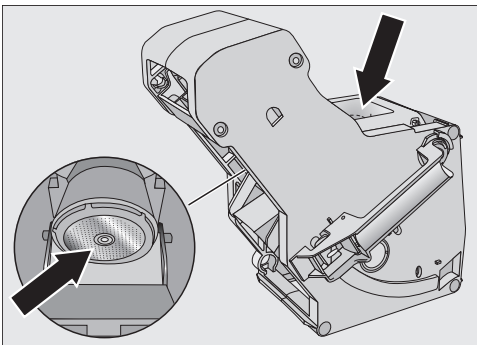

- Wipe any remaining coffee off the two filters (see arrows).
- Dry the funnel to prevent ground coffee from sticking to it the next time a coffee is made.

Cleaning and care

Place a cleaning tablet in the brew unit, place it in the machine and close the machine door. **appears on the display.**

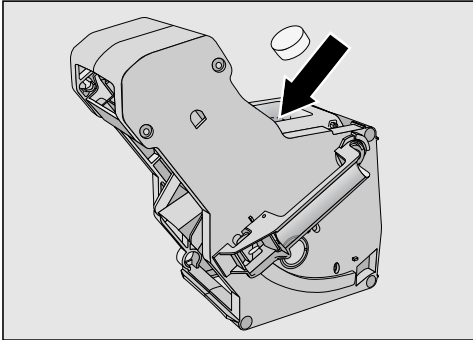

- Drop a cleaning tablet into the top of the brew unit (arrow).
- Push the brew unit with cleaning tablet back into the coffee machine, making sure it is straight.

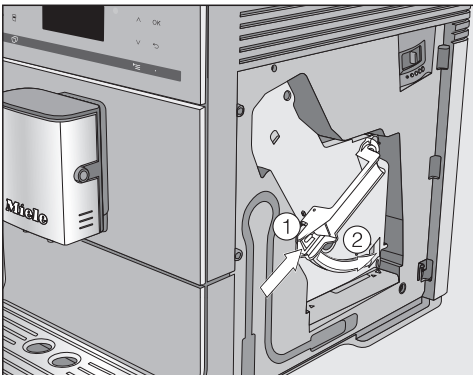

- Press the button on the end of the handle of the brew unit ① and while doing so turn the handle clockwise ②.
- Close the appliance door.
- Follow the further instructions given in the display.

The cleaning process is complete when rinsing has finished.

Degrease the brew unit following display reminder

No drinks can be made and Degrease the brew unit appears in the display.

The maintenance program cannot be cancelled. The process has to be carried through to the end.

- Tap OK.

The maintenance program will then start.

Descaling the appliance

Important! When descaling the appliance, cover delicate surfaces and natural flooring to prevent damage from splashes of descaling solution.

Ensure that any splashes of descaling solution are wiped up immediately.

Lime scale builds up in the coffee system through use. How often the appliance needs to be descaled will depend on the water hardness level in your area. It should be descaled regularly to ensure that it functions correctly.

The appliance will guide you through the descaling process. Various messages will appear in the display, e.g. you will be prompted to empty the drip tray or fill the water reservoir.

The descaling process is **required** and takes approx. 15 minutes.

The coffee machine prompts you in the display when it needs to be descaled.

No. of uses until appliance needs descaling: 50 will appear in the display. The remaining number of drinks that can be made before descaling will show in the display after each drink.

■ Confirm the message with *OK*.

When the number of remaining portions reaches 0, the coffee machine will lock out.

You can switch the coffee machine off if you do not want to carry out the descaling program at this point. You cannot make any drinks until the machine has been descaled.

Descaling following display reminder

Descal the appliance appears in the display.

The descaling process cannot be cancelled once you have tapped "OK." The process has to be completed through to the end.

■ Tap *OK*.

The process will start.

■ Follow the instructions in the display.

When Fill the water container with descaling agent and lukewarm water up to the descaling symbol  and place in appliance appears in the display, proceed as follows.

Preparing the descaling solution

We recommend using Miele descaling tablets for optimum results.

These have been specially developed for use with Miele coffee machines and prevent subsequent damage.

Other descaling agents, which contain other acids besides citric acid and/or other undesirable substances, such as chlorides for example, could damage the coffee machine. Moreover, the descaling effect required may not be guaranteed if the descaling solution is not of the appropriate concentration.

Miele descaling tablets are available to order via the Miele Webstore, from Miele Service or from your Miele dealer.

Descaling the appliance

You will need **one** descaling tablet to descale the machine.

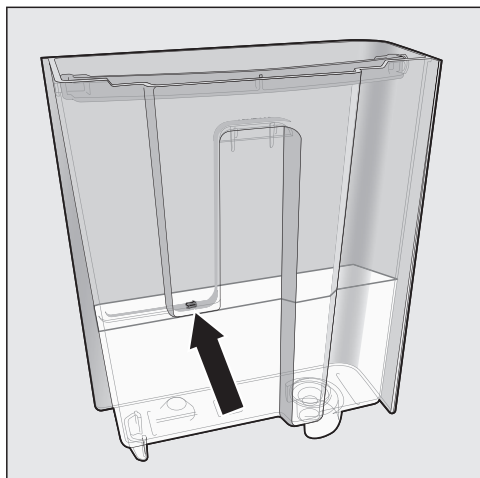

- Fill the water container to the  mark with lukewarm water.
- Place **one** descaling tablet in the water.

Follow the instructions for the mixing ratio carefully. It is important that you do not fill the water container with too much or too little water. Otherwise the descaling process will be canceled prematurely.

Carrying out descaling

- Reinstall the water container.
- Follow the additional instructions given in the display.

When Rinse the water container and fill with fresh tap water up to the descaling symbol  appears in the display:

- Remove the water container and rinse it thoroughly with clean water. Ensure that **no** descaling solution

residue remains in the water container. Fill the water container to the  mark with fresh tap water.

The cleaning process is complete when rinsing has finished. You can now prepare drinks again.

Ensure that any splashes of descaling solution are wiped up immediately. Otherwise surfaces can be damaged.

Descaling when not prompted by a message

- Tap .
- Select Maintenance and tap *OK*.
- Select Descal the appliance.

Descaling cannot be canceled once it has started. It must be completed through to the end.

- Tap *OK*.

The descaling process will start.



If the coffee system will not be used for an extended period of time, e.g. vacation, or will be transported over a long distance, the appliance should be prepared as follows.

- Empty and clean the coffee bean container
- Empty and clean the water reservoir
- Evaporating the coffee system
- Clean the interior of the machine
- Pack the machine securely

Evaporating the coffee machine

The coffee machine should be evaporated before it is stored for a long period of time or transported any distance – particularly at temperatures below freezing.

Evaporating means removing all water from the system. This prevents water and frost damage in the appliance.

- Turn the coffee machine on with the On/Off button .
- Tap .
- Tap  twice.

Empty the system? will appear in the display.

- Select Yes and tap OK.
- Follow the instructions on the display.

 **Caution! Danger of burning and scalding at the dispensers. Hot steam is discharged.**

The evaporation process is finished when Program finished appears on the display and the display then goes out.

- Switch off the machine and remove the plug from the electrical outlet to disconnect the appliance from the power supply.
- Clean the drip tray and grounds container.

Packaging

The coffee system should only be packed when it is clean and dry. Residues of coffee grounds can cause scratches on surfaces. Coffee and milk residues or water can cause a build-up of bacteria.

Use the original packaging including Styrofoam to pack the coffee system.

Also pack the operating instructions so that they are available when the coffee system is next used.

Frequently Asked Questions

With the help of the following guide minor faults in the performance of the machine, some of which may result from incorrect operation, can be remedied without contacting the Service Department.



This guide may help you to find the reason for the fault, and how to correct it.

Messages in the display



Error messages must be confirmed with *OK*, otherwise the message may reappear in the display even though the problem has been remedied.

To address the fault, follow the instructions on the display.

If the error message appears in the display again, contact Miele Technical Service.

Problem	Possible cause and solution
F1, F2, F80, F82	There is an internal fault. ■ Switch the coffee machine off with the On/Off button  . Wait for approx. one hour before switching it back on again.
F41, F42, F74, F77, F235, F236	There is an internal fault. ■ Turn the appliance off with the On / Off button  . Wait for 2 minutes before turning it back on again.
F10, F17	No water or very little water is being drawn in. ■ Remove the water container, fill it with fresh tap water, and replace it. ■ Carefully clean the surface the water container sits on, and the housing walls adjacent to the water container. Dry the surfaces.

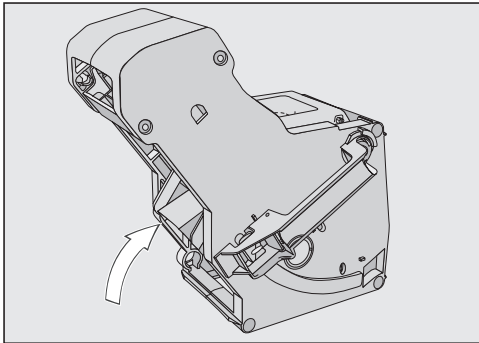
Frequently Asked Questions



Problem	Possible cause and solution
<p>F73 or Check the brew unit</p>	<p>The brew unit cannot be positioned correctly.</p> <ul style="list-style-type: none">■ Switch the machine off with the On/Off button .■ Remove the plug from the socket. Wait for two minutes before inserting the plug back in the socket.■ Remove the brew unit and rinse under running water.  <ul style="list-style-type: none">■ Push the coffee ejector of the brew unit into the correct position.■ Do not fit the brew unit. Close the service panel and switch the coffee machine on with the On/Off button . <p>This will initialize the brew unit motor and put it back into the start position.</p> <ul style="list-style-type: none">■ When Insert the brew unit appears in the display, put the brew unit back in the appliance. Close the service panel.

Frequently Asked Questions



Problem	Possible cause and solution
Too much ground coffee	<p>There is too much ground coffee in the ground coffee chute.</p> <p>The brew unit cannot compact ground coffee if more than two level spoonfuls of ground coffee are added to the coffee chute. The ground coffee will be emptied into the grounds container and the error message will appear in the display.</p> <ul style="list-style-type: none">■ Switch the machine off with the On/Off button .■ Remove and clean the brew unit by hand (see “Degreasing the brew unit and cleaning the interior”).■ Remove the ground coffee inside the coffee machine, e.g., with a vacuum cleaner.■ Place a maximum of 0.4 oz (12 g) of coffee in the ground coffee chute.

Frequently Asked Questions

Unusual performance of the coffee system

Problem	Possible cause and solution
The display remains dark when the coffee machine is turned on using the On/Off button .	The On/Off button  was not held for long enough. ■ Press and hold the On/Off button  for at least three seconds.
	The plug is not properly plugged into the electrical outlet. ■ Insert the plug into the outlet.
	The fuse has tripped because the coffee machine, voltage, or another appliance is defective. ■ Remove the plug from the socket. ■ Contact a technician or the Technical Service department.
The coffee machine turns off suddenly.	The switch-off time programmed using the timer has been reached. ■ If required, you can select a new switch-off time (see “Settings – Timer”).
	The plug is not properly plugged into the electrical outlet. ■ Insert the plug into the outlet.
The sensor buttons do not respond. The machine can no longer be operated.	There is an internal fault. ■ Disconnect power by unplugging the power cord from the electrical outlet and or switching off the circuit breaker.
The display is hard to see or not legible.	The display brightness has been set too low. ■ Change this setting (see “Settings”).

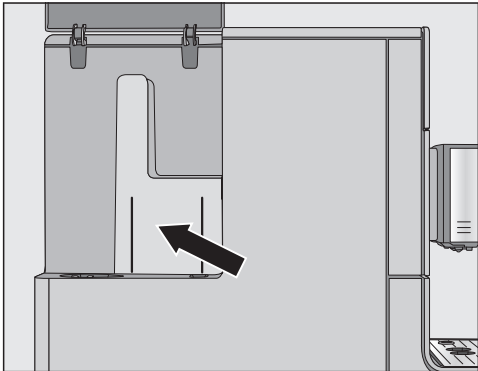
Frequently Asked Questions

Problem	Possible cause and solution
<p>The water container is empty. Fill and replace the water container has not appeared in the display.</p>	<p>Droplets of water have settled between the water container and the side walls of the housing, or this area is damp (see illustration).</p>  <ul style="list-style-type: none"> ■ Dry the surfaces. Take the water container out to refill it with water. <p>There is too much residual water on the inside walls of the water container, e.g., a biofilm has developed. Or the water container has a build-up of limescale.</p> <ul style="list-style-type: none"> ■ Clean the water container every day.
<p>Fill and replace the water container appears in the display even though the water container is full and in the machine.</p>	<p>The water container is not in the correct position.</p> <ul style="list-style-type: none"> ■ Remove the water container and push it back in again. <p>The water container was not correctly filled up and inserted during descaling.</p> <ul style="list-style-type: none"> ■ Fill the water container to the descaling mark[°]  and restart the descaling program.
<p>After switching on the machine, the message Empty the drip tray and the waste container appears even though they are both empty.</p>	<p>This is not a fault.</p> <p>When the drip tray and grounds container are emptied, the internal counter is not reset after the coffee machine has been switched off. Empty the drip tray and the waste container appears in the display even though the drip tray and the grounds container are not filled to the maximum.</p>

Frequently Asked Questions

Problem	Possible cause and solution
<p>Neither milk nor milk froth comes out of the main dispenser.</p>	<p>The milk pipework is blocked.</p> <ul style="list-style-type: none"> ■ Clean the main dispenser, taking particular care to clean the Cappuccinatore and milk pipework carefully with the cleaning brush.
<p>Empty the drip tray and the waste container appears in the display, even though the drip tray has been emptied.</p>	<p>The drip tray is not positioned correctly in the appliance.</p> <ul style="list-style-type: none"> ■ Push the drip tray in as far as it will go. ■ Make sure that the lower panel is sitting on the drip tray correctly.
	<p>When the drip tray and grounds container are emptied, the internal counter is not reset after the coffee machine has been switched off. Empty the drip tray and the waste container appears in the display even though the drip tray and the grounds container are not filled to the maximum.</p>
<p>Insert the drip tray and the waste container appears in the display even though both are fitted.</p>	<p>The drip tray is not correctly fitted and is therefore not detected.</p> <ul style="list-style-type: none"> ■ Empty the drip tray and grounds container. Reassemble all parts and push the drip tray back as far as it will go in the coffee machine.
<p>The drip tray or the grounds container is too full or runs over although the drip tray and the grounds container were emptied after each message on the display.</p>	<p>This is not a fault.</p> <p>The drip tray and grounds container were probably removed or the appliance was opened without the drip tray and grounds container being emptied. When the drip tray is removed or the appliance opened, the internal counter for emptying the drip tray and grounds container is automatically reset.</p> <ul style="list-style-type: none"> ■ Remove the drip tray and grounds container from the appliance and empty them.

Frequently Asked Questions

Problem	Possible cause and solution
<p>Fill the bean container appears in the display even though the bean container has just been filled.</p>	<p>This is not a fault.</p> <ul style="list-style-type: none">■ Confirm the message with <i>OK</i>. <p>Insufficient coffee beans are getting into the grinder. Have you used a dark roast? This type of coffee bean is often oily. These oils can cling to the inside of the coffee bean container and hinder the flow of beans.</p> <ul style="list-style-type: none">■ Make a coffee and observe whether the coffee beans drop into the coffee bean container.■ Clean the coffee bean container more often if you are using a darker, more oily bean. <p>Try other types of coffee bean which are less oily.</p>
<p>The coffee machine does not rinse itself when turned on.</p>	<p>This is not a fault.</p> <p>If the coffee machine is already at operating temperature, rinsing will not take place when the appliance is switched on.</p>

Frequently Asked Questions

Problem	Possible cause and solution
<p>Coffee dispensing is repeatedly interrupted and the message Fill the bean container appears in the display.</p>	<p>This is not a fault. The brew unit has not detected the ground coffee. The coffee may be too finely ground or there may not be enough of it. Usually, this is because the grinder is set too fine and the amount set is insufficient.</p> <ul style="list-style-type: none"> ■ Confirm the message with <i>OK</i>. <p>If the coffee is too strong for you or tastes bitter, try a different type of coffee bean.</p> <p>If the display appears with all types of coffee:</p> <ul style="list-style-type: none"> ■ Set the grinder to a coarser setting (see “Grinder setting”). ■ Check the amounts of coffee set for all coffee drinks (see “Amount of coffee”). Select a larger amount of coffee if necessary. <p>Don't forget to check any drinks changed in “User profiles”.</p> <p>If the message only appears when dispensing certain drinks:</p> <ul style="list-style-type: none"> ■ Check the amount of coffee set for this drink (see “Amount of coffee”). Select a larger amount of coffee. ■ You may also need to set a slightly coarser grinder setting.
<p>The descaling program was started unintentionally.</p>	<p>The descaling program cannot be stopped once the OK button has been tapped. Descaling must be continued through to completion. This is a safety precaution to make sure the machine is descaled correctly. This is important for the longevity and functional efficiency of your coffee system.</p> <ul style="list-style-type: none"> ■ Descal the coffee system (see “Descaling”).

Frequently Asked Questions

Problem	Possible cause and solution
<p>The milk sputters when it is dispensed. Hissing noises can be heard when milk is being heated up or frothed. Although the milk should be frothed, only hot milk comes out of the main dispenser.</p>	<p>The milk temperature is too high. Good milk froth can only be achieved when cold milk (below 50°F/10°C) is used.</p> <ul style="list-style-type: none"> ■ Check the temperature of the milk.
	<p>The main dispenser with integrated Cappuccinatore is not correctly fitted and is taking in air. Or the spouts are blocked.</p> <ul style="list-style-type: none"> ■ Check whether the main dispenser is correctly assembled. Make sure that all parts are tightly connected to one another. ■ If necessary, clean the main dispenser.
	<p>The milk pipework, connections, or the intake tube on the milk flask are blocked.</p> <ul style="list-style-type: none"> ■ Clean all parts thoroughly.
	<p>The steam jet on the main dispenser has a blockage.</p> <div data-bbox="400 724 878 1066" data-label="Image"> </div> <div data-bbox="404 1075 1046 1166" data-label="Text" style="border: 1px solid gray; padding: 5px;"> <p>Push the cleaning brush a maximum of 1 cm into the steam jet.</p> </div> <ul style="list-style-type: none"> ■ Clean the steam jet with the cleaning brush.
<p>Coffee grounds have settled on the lid of the drip tray and in the interior around the brew unit.</p>	<p>This does not indicate a fault. The movement of the brew unit during the brewing process can cause some ground coffee to fall around it. The type of beans used, the fineness of the ground coffee, and the amount of coffee ground also affect the amount. Important! Clean the interior of the coffee machine regularly to prevent mold, etc.</p>

Frequently Asked Questions

Problem	Possible cause and solution
The underside of the coffee bean container cover is very damp. Drops of water are visible.	A large number of drinks have been made one after the other and the ground coffee chute is not closed or not properly closed. Steam has risen up from the brew unit via the ground coffee chute and condensed under the cover. <ul style="list-style-type: none">■ Replace the lid on the ground coffee chute making sure it is properly sealed.
Water from making coffee has collected on the benchtop underneath the coffee machine.	This is not a fault. Water can get under the appliance when the drip tray is removed. Clean the surface underneath the coffee machine regularly.
The display lights up but the coffee machine does not heat up and no drinks are made. The coffee machine cannot be turned off.	The Demo mode for demonstrating the coffee machine in the showroom has been activated. <ul style="list-style-type: none">■ Deactivate Demo mode (see “Settings”).

Frequently Asked Questions

Unsatisfactory results

Problem	Possible cause and solution
<p>The coffee is not hot enough.</p>	<p>The cup has not been pre-heated. The smaller the cup and the thicker its walls, the more important it is to pre-heat it.</p> <ul style="list-style-type: none"> ■ Pre-heat the cup with hot water, for example. <p>The brewing temperature is set too low.</p> <ul style="list-style-type: none"> ■ Set a higher brewing temperature. <p>The filters in the brew unit are blocked.</p> <ul style="list-style-type: none"> ■ Remove the brew unit and clean it by hand. ■ Degrease the brew unit.
<p>Heating-up is taking longer. The amount of water is no longer correct and the coffee machine is not performing properly. Coffee flows into the cup very slowly.</p>	<p>The coffee machine needs to be descaled.</p> <ul style="list-style-type: none"> ■ Descale the coffee machine.
<p>Coffee is not flowing out of the main dispenser. Or coffee is only being dispensed via one spout.</p>	<p>The main dispenser has a blockage.</p> <ul style="list-style-type: none"> ■ Rinse the coffee pipework (see “Cleaning and care – Rinsing the appliance”). ■ If there is still no coffee coming out, or coffee is only coming out of one side, clean the dispensing spouts with the cleaning brush.
<p>The consistency of the milk froth is unsatisfactory.</p>	<p>The milk temperature is too high. Good milk froth can be achieved when cold milk (< 50°F/10°C) is used.</p> <ul style="list-style-type: none"> ■ Check the temperature of the milk in the milk flask. <p>The milk pipework is blocked.</p> <ul style="list-style-type: none"> ■ Clean the main dispenser with integrated cappuccinatore and the milk pipework with the cleaning brush supplied.

Frequently Asked Questions

Problem	Possible cause and solution
<p>The coffee grinder makes a louder noise than usual.</p>	<p>The coffee bean container has become empty during the grinding process.</p> <ul style="list-style-type: none"> ■ Fill the coffee bean container with fresh beans.
	<p>There may be foreign objects such as plastic or stones in amongst the coffee beans.</p> <ul style="list-style-type: none"> ■ Switch the coffee machine off immediately. Contact the Technical Service department.
<p>The coffee flows too quickly into the cup.</p>	<p>The grind level is too coarse.</p> <ul style="list-style-type: none"> ■ Set the grinder to a finer setting (see “Setting the coffee grinder”).
<p>The coffee trickles too slowly into the cup.</p>	<p>The grind level is too fine.</p> <ul style="list-style-type: none"> ■ Set the grinder to a coarser setting (see “Grinder setting”).
<p>The crema on the coffee or espresso is not as it should be.</p>	<p>The grinder setting is not correct.</p> <ul style="list-style-type: none"> ■ Set the grinder to a finer or coarser setting.
	<p>The brew temperature is too high for the type of coffee being used.</p> <ul style="list-style-type: none"> ■ Set a lower brewing temperature.
	<p>The coffee beans are no longer fresh.</p> <ul style="list-style-type: none"> ■ Add fresh beans to the coffee bean container.

Technical Service

Contact in case of fault

In the event of a fault which you cannot remedy yourself, please contact your Miele dealer or Miele Technical Service.

Contact information for Miele Technical Service can be found at the end of this document.

Please quote the model and serial number of your appliance when contacting Miele. Both pieces of information can be found on the data plate.

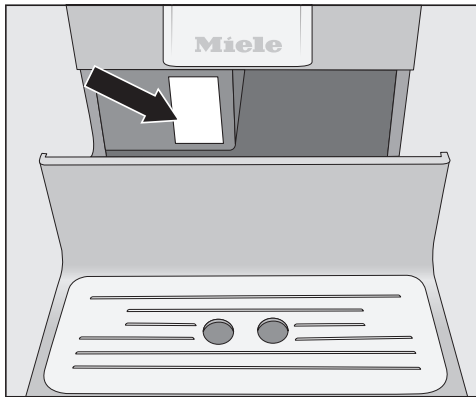

Warranty

For further information, please refer to your warranty booklet.

The following tips can help you save energy and money as well as help the environment:

- Operate the coffee machine in “Eco mode” (pre-set).
- Energy consumption may increase if you change the factory default settings for the “timer”.

This setting uses more energy **appears in the display.**

- Switch the coffee machine off with the On/Off button  when it is not in use.
- Change the setting for the “Switch off after” timer to 15 minutes. Then the coffee machine will switch off 15 minutes after the last drink has been made or a sensor button has been tapped.

Electrical connection

Before connecting the coffee machine, make sure that the connection data on the data plate (voltage and frequency) matches the domestic electrical supply. This data must correspond in order to avoid the risk of damage to the coffee machine. Consult a qualified electrician if in any doubt.

The connection data is given on the data plate. The data plate can be seen on the left-hand side of the appliance when the drip tray is pulled out.

The appliance is supplied with a mains cable ready for connection to an AC 50 Hz 220–240 V supply.

The coffee machine must be connected to the mains supply via a suitable switched socket with earthing contact. The machine must be connected to an electrical system designed in accordance with national regulations (VDE 0100 in Germany).

The fuse rating must be at least 10 A.

The socket should be next to the appliance and easily accessible where possible.

Do not connect the coffee machine to the power supply using a multi-socket adapter or an extension lead. These do not guarantee the required safety of the appliance (risk of fire).

Do not connect the coffee machine to a **stand-alone inverter**. These devices are used for autonomous power supply, such as a solar power system. Power surges could cause a safety shutdown. This can damage the electronic.

The coffee machine must not be used with **energy saving plugs**. These reduce the energy supply to the appliance, which could generate excessive heat.

If the power cable is faulty, it may only be replaced by a qualified electrician.

Danger of overheating!

Please ensure that there is adequate ventilation around the appliance.

Do not cover the appliance with dish towels or similar objects while it is in use.

Danger of overheating

If the coffee machine is installed behind a kitchen furniture door, it may only be used with the furniture door open.

Do not close the furniture door while the coffee machine is in use.

Please observe the following installation instructions:

- The location of the appliance must be dry and well ventilated.
- The ambient temperature of the room in which the appliance is used must be between +50°F and +100°F (+10°C and +38°C).
- The coffee system must be set up on a level surface. The surface must be water resistant.

If the coffee machine is installed in a niche, the niche must provide the following minimum dimensions:

Height	20 1/16" (510 mm)
Width	17 11/16" (450 mm)
Depth	22 5/8" (575 mm)

When setting up the appliance: Make sure that the service panel can be fully opened so that the brew unit can be removed with ease when required.

- The coffee machine must be set up in the niche such that it sits flush with the front edge of the niche.

Appliance dimensions

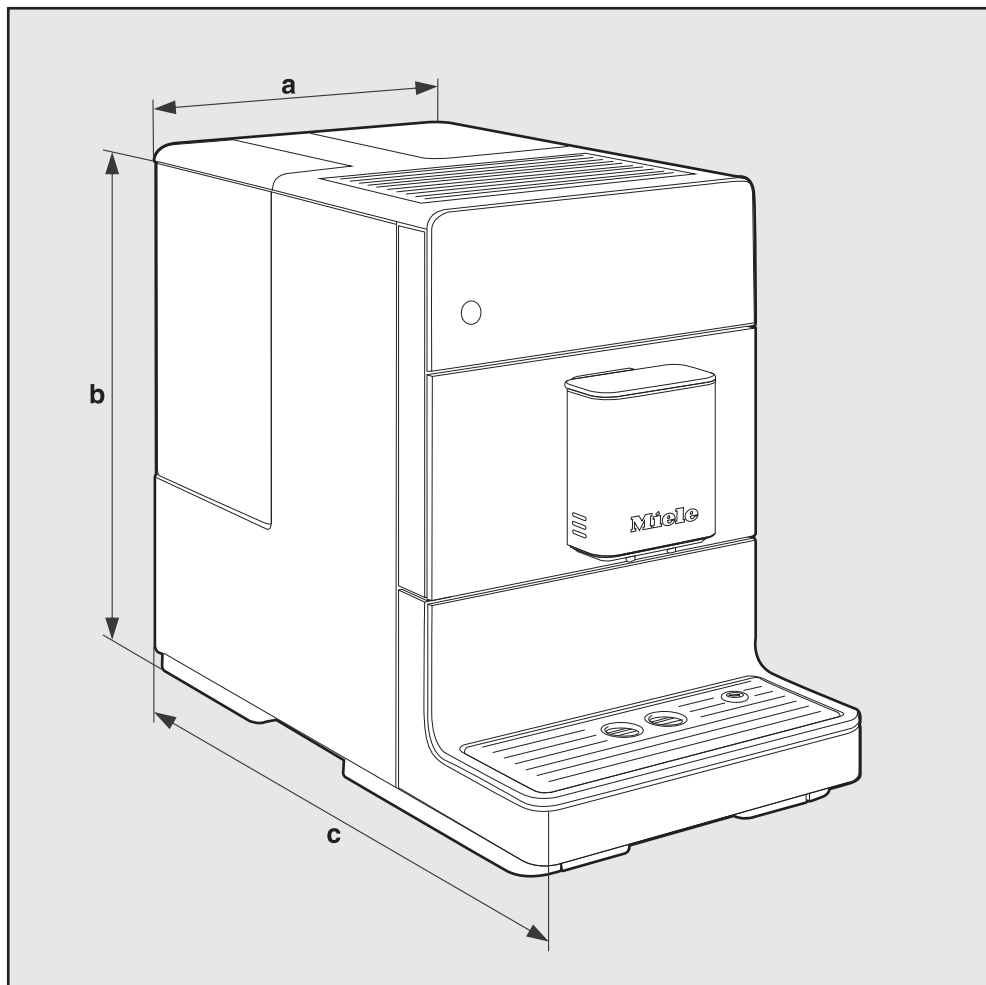

a = 9 1/2" (241 mm)

b = 14 3/16" (360 mm)

c = 18 1/8" (460 mm)

Technical data

Current draw in standby mode (default setting):	< 0.5 watt
Pump pressure:	max. 217 psi (15 bar)
Through-flow heater:	1 stainless-steel thermo block
Dimensions (W x H x D):	9 1/2" x 14 3/16" x 18 1/8" (241 x 360 x 460 mm)
Net weight:	21 lb (9,48 kg)
Power cord length:	3' 11 1/4" (120 cm)
Water container capacity:	4 1/4 c (1,3 l)
Bean container capacity:	0.44 lb (200 g)
Grounds container capacity:	Max. 6 portions of coffee grounds
Main dispenser:	Height adjustable from 3 1/8"-5 5/16" (80–135 mm)
Grinder:	Stainless-steel conical grinder
Grinder setting:	Adjustable in 5 settings
Ground coffee amount:	Max. 0.4 oz (12 g)

**Please have the model and serial number
of your appliance available when
contacting Technical Service.**

The Miele logo consists of the word "Miele" in a bold, white, serif font, set against a solid black rectangular background.

U.S.A.

Miele, Inc.

National Headquarters

9 Independence Way
Princeton, NJ 08540
Phone: 800-843-7231
Fax: 609-419-4298
www.mieleusa.com

Technical Service & Support

Phone: 800-999-1360
Fax: 888-586-8056
TechnicalService@mieleusa.com

International Headquarters

Miele & Cie. KG
Carl-Miele-Straße 29
33332 Gütersloh
Germany

Canada

**Importer
Miele Limited**

Headquarters and Miele Centre

161 Four Valley Drive
Vaughan, ON L4K 4V8
www.miele.ca

Customer Care Centre

Phone: 800-565-6435
905-532-2272
customercare@miele.ca

CM 5300, CM 5400, CM 5500

en – US, CA

M.-Nr. 10 973 070 / 02