

Operating Instructions Countertop Coffee Machine



To prevent accidents and machine damage, you **must** read these instructions before installation or use.

Caring for the environment

Packaging material

The packaging material used protects the machine during transportation. Please retain the original box and polystyrene pieces so that you can pack the appliance securely, should you need to transport it in the future.

Disposal of your old appliance

Electrical and electronic appliances contain valuable materials. They also contain certain substances, compounds and components which were essential for the proper functioning and safe use of the equipment. Handling these materials improperly by disposing of them in your household waste can be harmful to your health and the environment. Therefore, please do not dispose of your old appliance with regular household waste and follow local regulations on proper disposal.



Consult with local authorities, dealers or Miele in order to dispose of and recycle electrical and electronic appliances. Miele assumes no responsibility for deleting any personal data left on the appliance being disposed. Please ensure that your old appliance is kept away from children until removal. Observe safety requirements for appliances that may tip over or pose an entrapment hazard.

Caring for the environment	2
IMPORTANT SAFETY INSTRUCTIONS	6
Machine description	16
Controls and indicators	17
Accessories	18
Operation	19
Before first use	20
Water hardness	22
Filling the water tank	23
Filling the coffee bean container	24
Switching on and off	25
Adjusting the coffee dispensers to the cup height	26
Preparing beverages	27
Making coffee with and without milk.....	27
Milk preparation.....	27
Using milk from milk cartons or other suitable containers	28
Making a coffee drink.....	28
Canceling a drink.....	28
2 portions (☑ sensor button)	29
Coffee pot.....	29
Making coffee drinks from ground coffee	30
Adding ground coffee.....	30
Dispensing hot water (CM 5410, CM 5510, CM 5710).....	31
Grinder setting	32
Amount of coffee, brew temperature, and pre-brewing	33
Amount of coffee	33
Brewing temperature	33
Pre-brewing ground coffee.....	33
Portion size	34
Profiles	36
Creating profiles	36

Contents

Changing drinks within a profile	36
Making drinks stored in a profile	36
Changing the name	36
Delete profile	37
Setting when the profile should change (Change profile)	37
Settings	38
Displaying and changing Settings	38
Language.....	38
Timer: switch off after.....	38
Eco mode	38
Info (display information)	38
System lock 	38
Water hardness	38
Display brightness	38
Volume.....	38
Factory default settings	38
Demo mode (showroom program)	39
Cleaning and care	40
Overview of cleaning intervals.....	40
Clean by hand or in dishwasher	41
Unsuitable cleaning agents	42
Grounds container, drip tray, and drip tray cover	43
Cleaning the water container	44
Removing and cleaning the water container filter	44
Main dispenser	44
Milk pipe	46
Bean container and ground coffee chute	47
Cleaning the casing.....	47
Opening the Maintenance menu	48
Rinsing the machine	48
Rinsing the milk pipe	48
Degreasing the brew unit and cleaning the interior	50
Descaling the appliance	52
Transport	55
Evaporating the coffee machine.....	55
Packaging.....	55
Frequently Asked Questions	56
Messages in the display	56
Unusual performance of the coffee system	59
Unsatisfactory results.....	65

Contents

Service and warranty	67
Contact in the event of a fault	67
Appliance warranty and product registration	67
Saving energy	68
Electrical connection	69
Installation	70
Appliance dimensions	71
Technical data	72

IMPORTANT SAFETY INSTRUCTIONS

This coffee machine complies with all current safety requirements. Inappropriate use can, however, lead to personal injury and material damage.

Read the operating instructions carefully before using the coffee machine. They contain important information on the installation, safety, use and maintenance of the appliance. This prevents both personal injury and damage to the coffee machine.

Miele strongly advises you to read and follow the instructions in the chapter on installing and connecting the coffee machine as well as the IMPORTANT SAFETY INSTRUCTIONS.

Miele cannot be held liable for injury or damage caused by non-compliance with these instructions.

Keep these operating instructions in a safe place and pass them on to any future owner.

IMPORTANT SAFETY INSTRUCTIONS

Intended use

- ▶ This coffee machine is intended for household use.
- ▶ Do not use the coffee machine outdoors.
- ▶ This coffee machine must not be used at altitudes above 6560 ft (2000 m).
- ▶ The machine is intended only for the preparation of coffee-based drinks such as espresso, cappuccino, latte macchiato etc. Any other usage is not supported.
- ▶ Persons who lack physical, sensory or mental abilities or experience with the machine should not use it without supervision or instruction by a responsible person.

IMPORTANT SAFETY INSTRUCTIONS

Safety with children

 Danger of burning and scalding at the dispensers.

Children's skin is far more sensitive to high temperatures than that of adults.

Ensure children do not touch hot surfaces of the coffee machine or place parts of their body under the dispensers.

- ▶ Keep the coffee system out of reach of children.
- ▶ Keep children away from the coffee machine and the power cord.
- ▶ Children must be aware of the potential dangers caused by incorrect operation.
- ▶ Children should be supervised when they are near the coffee system. Do not allow them to play with it or to use the controls.
- ▶ Children must not be allowed to clean the coffee machine unsupervised.
- ▶ Remember that coffee and espresso are not suitable drinks for children.
- ▶ Danger of suffocation. While playing, children may become entangled in packaging material (such as plastic wrapping) or pull the packaging material over their head, presenting the risk of suffocation. Keep packaging material away from children.

IMPORTANT SAFETY INSTRUCTIONS

Technical safety

▶ Before installing the coffee system, check for externally visible damage. If the coffee system is damaged, it may pose a safety hazard and must not be used under any circumstances.

▶ Before connecting the coffee system, check the voltage and frequency indicated on the data plate against the voltage and frequency of the household electrical supply.

This data must correspond in order to prevent damage to the coffee system. If in doubt, consult a qualified electrician.

▶ Be certain your appliance is properly installed and grounded by a qualified technician. To guarantee the electrical safety of this appliance, continuity must exist between the appliance and an effective grounding system. It is imperative that this basic safety requirement be met. If there is any doubt, have the electrical system of the house checked by a qualified electrician.

▶ Temporary or permanent operation on an autonomous power supply system or a power supply system that is not synchronized with the grid power supply (e.g., island networks, back-up systems) is possible. A prerequisite for operation is that the power supply system complies with national and local codes.

The function and operation of the protective measures provided in the domestic electrical installation and in this Miele product must also be maintained in isolated operation or in operation that is not synchronized with the grid power supply, or these measures must be replaced by equivalent measures in the installation.

▶ Do not connect the machine to the electrical supply using an extension cord or power bar.

▶ The coffee machine may not be used in mobile installations such as ships.

▶ Unplug the coffee machine from the power supply immediately if you notice any damage or smell burning.

IMPORTANT SAFETY INSTRUCTIONS

- ▶ Do not operate any appliance with a damaged cord or plug or after the appliance malfunctions, or has been damaged in any manner. Return appliance to the nearest authorized service facility for examination, repair or adjustment.
- ▶ Ensure that the power cord will not be pinched or damaged by any sharp edges.
- ▶ The power cord should not hang down. Someone could trip over it with the risk of injury and the appliance could be damaged.
- ▶ Do not let cord hang over edge of table or counter, or touch hot surfaces.
- ▶ Do not place on or near a hot gas or electric burner, or in a heated oven.
- ▶ Only use the coffee system in rooms where the ambient temperature is between +50°F (10°C) and +100°F (38°C).
- ▶ Position the coffee machine at a height of at least 34" (850 mm) from the floor.
- ▶ Danger of overheating. Please ensure that there is adequate ventilation around the coffee machine. Do not cover the coffee machine with dish towels, etc. while it is in use.
- ▶ If the coffee machine is installed behind a closed cabinet front, it may only be used with the cabinet door open (see "Installation" for the minimum niche size). Heat and moisture can build up behind the cabinet front when closed. This can result in damage to the machine and/or cabinetry. Do not close the cabinet door while the coffee machine is in use. Leave the cabinet door open until the coffee machine has cooled down completely.
- ▶ Protect the coffee system from water and water spray. Do not immerse the appliance in water.

IMPORTANT SAFETY INSTRUCTIONS

- ▶ Repairs and other work by unqualified persons to the appliance and the power cord could be dangerous. The manufacturer cannot be held liable for unauthorized work. Repairs may only be carried out by a Miele-authorized service technician.
- ▶ The manufacturer's warranty may be invalidated if the appliance is not repaired by a Miele approved service technician from Technical Service.
- ▶ For repairs, the coffee system must be disconnected from the electrical power supply.
The coffee system is only disconnected from the power supply if
 - The power cord has been unplugged.
Unplug the cord by pulling on the plug, not on the cord.
 - The fuses to the household power supply are turned off.
 - Any screw-in fuses in the household supply are fully unscrewed.
- ▶ Never open the outer casing of the machine. Tampering with electrical connections or components and mechanical parts is highly dangerous to the user and can cause operational faults or electric shock.
- ▶ To protect against fire, electric shock and injury to persons do not immerse cord, plugs, or coffee machine in water or other liquid.
- ▶ Disconnect the coffee system from the power supply if it is not going to be used for some time.
- ▶ Only use genuine Miele accessories. If other parts are used, warranty, performance, and/or product liability claims may be invalidated.

IMPORTANT SAFETY INSTRUCTIONS

Proper use

 Danger of burning and scalding at the dispensers. The liquids and steam dispensed are very hot.

Keep away from the area underneath the dispensers when hot liquids and steam are being dispensed.

Do not touch hot components.

Hot liquid or steam could spatter from the spouts. Ensure that the main dispenser is clean and installed correctly.

Water in the drip tray can also be very hot. Take care when emptying it.

▶ Please note the following regarding water:

- The water quality must conform to the requirements for drinking water in the country in which the coffee machine is being used.
- Only use cold, fresh tap water to fill the water container. Hot or warm water or other liquids can damage the coffee machine.
- Change the water every day to prevent a build-up of bacteria.
- Do not use sparkling water.

▶ Only fill the bean container with roasted espresso or coffee beans. Do not fill the bean container with coffee beans that have been treated with additives or with ground coffee.

▶ Do not pour liquids into the bean container.

▶ Do not use green (unroasted) coffee beans or mixtures of coffee beans which contain green coffee beans. Green coffee beans are very hard and still contain residual moisture. These can damage the coffee machine grinder as soon as grinding begins.

▶ Do not use oily beans or beans that have been treated with caramel, sugar, or other substances. Sugar and oil will damage the coffee system.

▶ Only fill the coffee chute with ground coffee beans.

IMPORTANT SAFETY INSTRUCTIONS

- ▶ Do not use any flavored ground coffee. The sugar in the coffee will stick to and block the brew unit of the coffee system. The cleaning tablets for degreasing the brew unit will not remove this type of deposit.
- ▶ Only use plain milk. Most sugary additives can clog the milk lines and damage the machine.
- ▶ If using dairy milk make sure that it has been pasteurized.
- ▶ Do not place flaming alcohol mixtures underneath the main dispenser. The flames could ignite plastic components and cause them to melt.
- ▶ Do not use open flames, such as a candle, on or near the coffee machine. The coffee machine could catch fire with the risk of the fire spreading.
- ▶ Do not use the coffee system to clean objects.

IMPORTANT SAFETY INSTRUCTIONS

Accessories and parts

- ▶ Miele can only guarantee the safety of the appliance when genuine Miele replacement parts are used. Faulty components should only be replaced by genuine Miele replacement parts.
- ▶ Only use genuine Miele accessories. If other parts are used, warranty, performance, and/or product liability claims may be invalidated.
- ▶ Miele will guarantee to supply functional spare parts for a minimum of 10 years and up to 15 years following the discontinuation of your coffee machine.

Cleaning and care

- ▶ Turn the coffee system off at the main switch before cleaning.
- ▶ Clean the coffee machine daily, particularly before using for the first time (see “Cleaning and care”).
- ▶ All parts of the milk system need to be cleaned thoroughly and regularly.
- ▶ Do not use a steam cleaner to clean this machine. Steam could reach electrical components and cause a short circuit.
- ▶ Descale the coffee system regularly depending on the water hardness level in your area. Descale the machine more frequently in areas with very hard water. Miele cannot be held liable for damage arising from insufficient descaling, the use of incorrect descaling agent or the use of descaling agent that is not of the appropriate concentration.
- ▶ Degrease the brew unit regularly with Miele cleaning tablets. Depending on the natural oil content of the coffee used, the brew unit can become blocked quite quickly.
- ▶ Rinsing coffee grounds down the drain can cause the sink to clog. Instead, dispose of your coffee grounds appropriately as biodegradable waste (where facilities exist) or by composting.

IMPORTANT SAFETY INSTRUCTIONS

For machines with stainless steel surfaces:

- ▶ Do not use sticky notes, transparent adhesive tape, masking tape, or other types of adhesive on the stainless steel surfaces.
- ▶ Stainless-steel surfaces are susceptible to scratching. Even magnets can cause scratches.

SAVE THESE INSTRUCTIONS



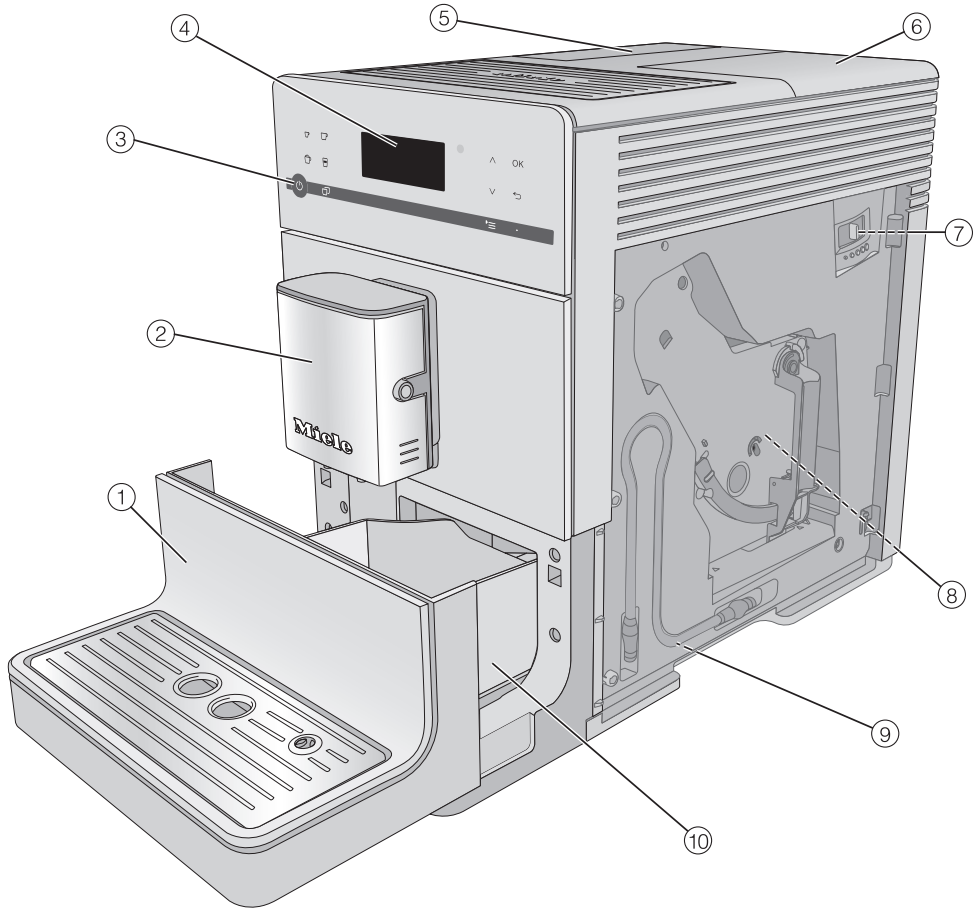





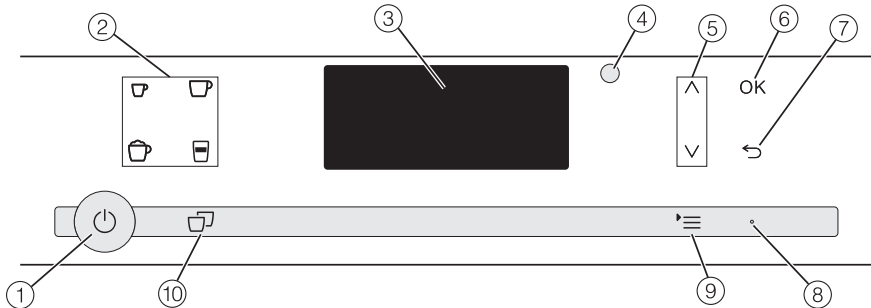

Machine description



- ① Lower panel with drip tray cover
- ② Main dispenser with Cappuccinatore and hot water dispenser
- ③ On/Off button 
- ④ Control panel
- ⑤ Water container
- ⑥ Bean container and ground coffee chute
- ⑦ Grinder setting (behind the service panel)
- ⑧ Brew unit (behind the service panel)
- ⑨ Park position for milk pipework
- ⑩ Drip tray with lid and grounds container

Controls and indicators



- ① **On/Off button** 
For switching coffee machine on and off
- ② **Drink buttons**
For making drinks
 -  Espresso
 -  Coffee
 -  Capuccino
 -  Latte macchiato
- ③ **Display**
For showing information about the current action or status
- ④ **Optical interface**
(for Miele Technical Service only)
- ⑤ **Arrow buttons**  
For scrolling through lists, selecting entries, or changing values
- ⑥ **OK sensor button**
For confirming display messages and saving settings
- ⑦ **“Back”**  **sensor button**
For returning to the previous menu and canceling unwanted actions
- ⑧ **LED**
Flashes when the appliance is switched on and the display is in energy saving mode
- ⑨ **☰ sensor button**
Additional drinks
Profiles (CM 5410, CM 5510, CM 5710)
Maintenance
Parameters
Settings 
- ⑩ **“2 portions”**  **sensor button**
For dispensing 2 portions of a drink at once

Accessories

These products and other useful accessories can be ordered via the Miele Webstore, from Miele Service or from your Miele dealer.

Included accessories

- **Miele “Welcome Pack”**
Different cleaning products are supplied depending on model.
- **Cleaning brush**
for cleaning the milk pipework, for example.

Optional accessories

Miele also offers a range of optional accessories, as well as cleaning and conditioning products for your coffee system.

- **Cleaning agent for milk pipework**
for cleaning the milk system
- **Cleaning tablets**
for degreasing the brew unit
- **Descaling tablets**
for descaling the water pipework
- **CJ Jug 1.0 l**
Insulated flask for coffee or tea (pot function)
- **Milk flask with lid**
For storing and preparing milk

Sensor buttons

To operate the coffee machine, tap the sensor buttons with your finger.

An audible signal is generated each time a button is tapped. You can adjust the volume of the signal tones or switch the tones off (see “Settings – Volume”).

Drinks menu

When the following appears in the display, you are in the drinks menu:
Select drink.

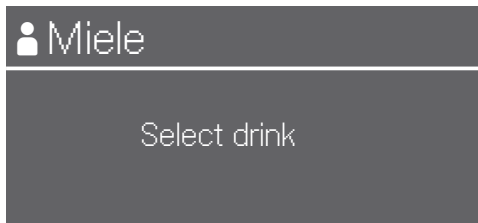

You can find more drinks in the Additional drinks menu (*≡ sensor button).

Selecting a menu and navigating within a menu

To select a menu, tap the '≡ sensor button.



You will then be able to start an action or change settings in the menu. A scroll bar at the right of the display shows that additional options or text are available.

To select an option, tap the arrow buttons ^ and v until the option you want is highlighted.

Tap *OK* to confirm your selection.

The setting which is currently selected in a list will have a checkmark ✓ beside it.

Exiting a menu or canceling an action

To exit the current menu, tap the ↵ sensor button.

Before first use

Before using for the first time

- Remove any notices from the machine.

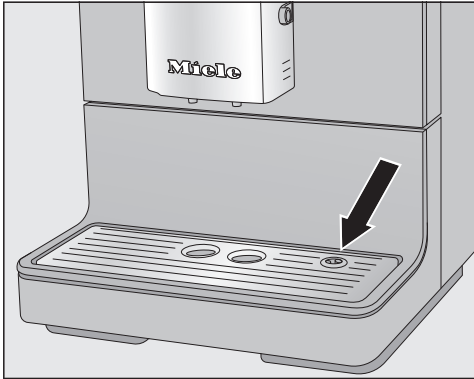

- Remove the protective film from the drip tray cover and place it into the lower panel.
- Place the coffee machine on a level flat surface that is not sensitive to water (see “Installation”).

Clean the coffee machine thoroughly (see “Cleaning and care”) before filling it with water and coffee beans.

- Insert the plug of the coffee machine into the socket.
- Remove the water container and fill it with fresh, cold tap water. Only fill the container up to the “max.” mark and then reinsert the water container.
- Take the lid off the coffee bean container, fill it with roasted coffee beans, and replace the lid.

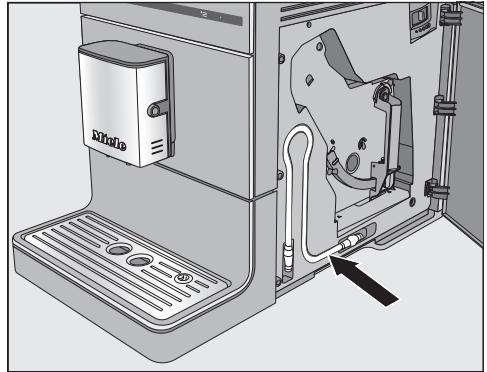

Tip: The milk pipe can be stored behind the service panel when not in use.

Turning on for the first time

- Tap the On/Off button .

Miele - Willkommen appears briefly in the display.

- Use the arrow buttons \wedge \vee to highlight the required language. Tap *OK*.

You might also be asked for your location.

Your machine has been successfully set up and is ready for use.

- Confirm with *OK*.

The coffee machine heats up and rinses the pipework. The water used for rinsing will run out of the main dispenser.

- Before preparing milk for the first time, rinse the milk pipework (see “Cleaning and care – Rinsing the milk pipework”).

Please note that the coffee aroma and the characteristic crema only develops after the first few coffees have been made.

To ensure that any coffee residues from the factory testing process are removed from the brewing system, please throw away the first 2 cups of coffee when using the coffee machine for the first time.

A larger quantity of coffee beans is ground for the first coffee drinks. Powder from the coffee grounds may adhere to the lid of the drip tray.

Water hardness

Water hardness is an indication of the amount of minerals dissolved in water. The more minerals in the water, the higher the water hardness. The harder the water is, the more frequently the coffee machine needs to be descaled.

The coffee machine measures the amount of water used and steam made. Depending on the level of water hardness set, more or fewer drinks can be dispensed before the appliance needs to be descaled.

Program the coffee machine to the water hardness level of your area so that it functions correctly and does not get damaged. A prompt to descale the machine will then appear in the display at the correct time.

Your local water authority will be able to tell you the hardness of the water in your area.

The water hardness level is set to 3 at the factory.

The appliance has 4 programmable hardness levels:

°dH	gr/gal	ppm (mg/l CaCO ₃)	Set- ting*
0–8.4	0–8.7	0–150	Soft 1
8.4–14	8.7–14.6	150–250	Medium 2
14–21	14.6–21.9	250–375	Hard 3
> 21	> 21.9	> 375	Very hard 4

* The hardness levels shown in the display may differ from the hardness level designations in your area. You **must** follow the values in the chart to set the correct water hardness level for your area.

Setting water hardness

- Tap the '☰ sensor button.
- Select Settings  | Water hardness and confirm with **OK**.
- Select the hardness level and confirm with **OK**.

The setting is now saved.

Filling the water tank

⚠ Risk to health due to contaminated water.

Bacteria can develop in water which has been sitting in the water container for too long and is a risk to your health.

Change the water in the water container **every day**.

⚠ Risk of damage due to incorrect operation.

Unsuitable liquids such as hot or warm water or other liquids can damage the coffee machine.

Carbonated water leaves too much limescale in the coffee machine.

Only use cold, fresh tap water to fill the water container.

- Replace the water container and close the lid.

Make sure that the water container handle is on the right so that the lid can close properly.

If the water container sits a little too high or at an angle, check that it is fitted correctly or whether the surface that it is sitting on is soiled. Water could leak. If necessary, clean the surface that the water container sits on.

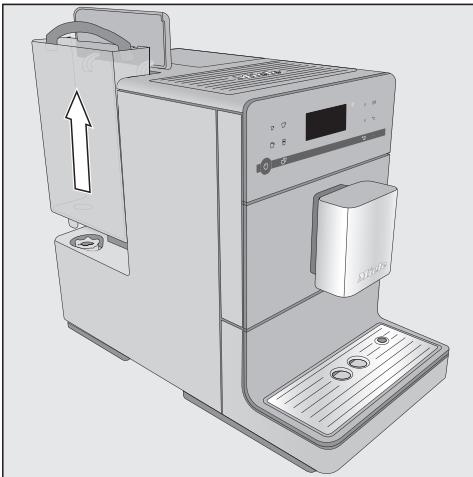

- Open the lid on the left-hand side of the coffee machine.
- Pull the water container up and out of the appliance.
- Fill the water container with fresh, cold tap water up to the *max.* mark.

Filling the coffee bean container

Coffee or espresso can be made from whole roasted coffee beans which are freshly ground for each cup. This requires the coffee bean container to be filled with coffee beans.

Alternatively, you can make coffee drinks with ready ground coffee.



Risk of damage to the grinder due to incorrect operation.

The coffee machine will be damaged if the bean container is filled with unsuitable substances such as liquids, ground coffee, or coffee beans treated with sugar, caramel, or similar.

In addition, green (unroasted) coffee beans or mixtures of coffee beans which contain green coffee beans can damage the grinder. Green coffee beans are very hard and still contain residual moisture. These can damage the coffee machine grinder as soon as grinding begins.

Only put roasted coffee beans in the bean container.

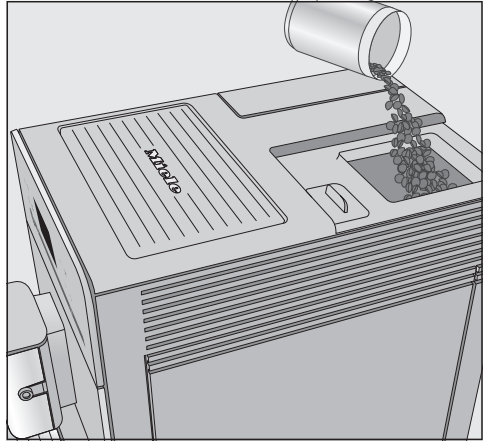

- Take the lid off the coffee bean container.
- Fill the bean container with roasted coffee beans.
- Replace the lid.

Tip: You can use a nut or seed grinder to grind green coffee beans. These grinders generally have a rotating stainless steel blade. You can then add the ground green coffee **one portion at a time** to the ground coffee chute and make the desired coffee drink.

Switching the coffee machine on

- Tap the On/Off button .

The appliance heats up and rinses the pipework. Hot water will run out of the main dispenser.

When *Select drink* appears in the display, you can make drinks.

If the coffee machine is already at operating temperature, rinsing will not take place when the appliance is switched on.

If no buttons are touched or maintenance programs carried out, the display will turn off after approx.

7 minutes to save energy.

The LED on the right flashes as long as the machine is switched on.

- Tap any one of the sensor buttons to wake the appliance up again to make a drink.

Switching the coffee machine off

- Tap the On/Off button .

If coffee has been dispensed, the coffee machine will rinse the pipework automatically before switching off.

If you have made a drink using milk, Place milk pipe in drip tray will appear in the display.

- Insert the end of the milk pipe into the aperture in the drip tray, and then tap *OK*.

Switching off for longer periods of time

If the coffee machine is not going to be used for a while, e.g., if you are going on vacation, remember to do the following:

- Empty the drip tray, the grounds container, and the water container.
- Clean all parts thoroughly, including the brew unit.
- If necessary, switch off the machine and remove the plug from the electrical outlet to disconnect the appliance from the power supply.

Adjusting the coffee dispensers to the cup height

You can adjust the main dispenser to suit the height of the cup you are using so that the coffee or espresso will not cool down as quickly and the crema will have a better consistency.

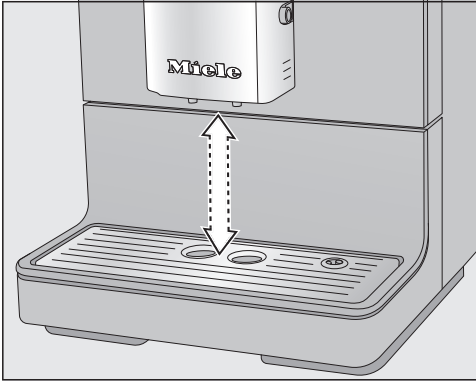

- Pull the main dispenser down until it is at the same level as the rim of the cup.

Alternatively, push the main dispenser up until there is enough room to fit a larger cup or mug underneath.

 Danger of burning and scalding at the dispensers.

The liquids and steam dispensed are very hot and can cause scalding.

Keep away from the area underneath the dispensers when hot liquids and steam are being dispensed.

Do not touch hot components.

Making coffee with and without milk

The following drinks can be made:

- **Ristretto** is a concentrated, stronger espresso. It is prepared with the same amount of coffee as for an espresso but with a lot less water.
- **Espresso** is a strong aromatic coffee with a thick hazelnut-brown colored froth – known as the crema – on top. We recommend using espresso-roasted coffee beans to make an espresso.
- **Coffee** differs from espresso by the increased amount of water and the roast of the beans. We recommend using coffee beans of the correct roast to make the coffee.
- **Lungo** is a coffee with significantly more water.
- **Capuccino** consists of approx. 2 thirds milk froth and 1 third espresso.
- **Latte macchiato** consists of 1 third each of hot milk, milk froth, and espresso.
- **Caffè latte** consists of espresso and hot milk.

Hot milk and **milk froth** can also be made.

Milk preparation

Milk or milk alternatives (e.g., soy milk) containing added sugar can clog up the milk pipe and the rest of the milk pipework. Residues from unsuitable liquids can interfere with milk preparation.

The milk used must not contain any additives.

Only use pasteurized cow's milk.

If you have not made any milk drinks for a while, rinse the milk pipework thoroughly before making the first drink.

Tip: Using cold cow's milk (< 50°F/10°C) with a protein content of at least 3% will produce the perfect milk froth.

You can select milk with a fat content according to your personal preference. With whole milk (at least 3.5% fat), the milk froth will be slightly creamier than with low-fat milk.

Preparing beverages

Using milk from milk cartons or other suitable containers

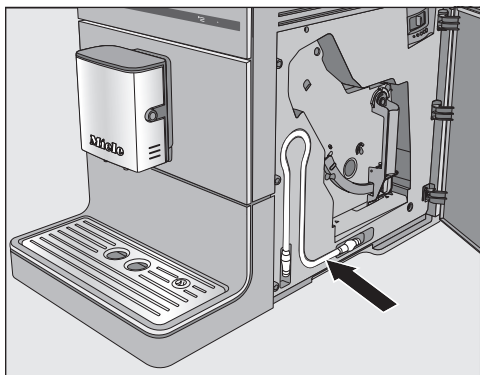

The milk pipe is located behind the service panel.



- Connect the milk pipe to the aperture in the main dispenser.
- Place a container with sufficient milk next to the coffee machine.
- Place the end of the milk pipe in the container. Make sure that it is sufficiently immersed in the milk.

Tip: The Miele milk flask is the perfect addition to Miele coffee machines if you make a lot of coffees with milk. The milk flask is dishwasher-safe and easy to store in the fridge after preparing. Good milk froth can only be made with cold milk (< 50°F/10°C).

The Miele milk flask is available to order from the Miele online shop, from Miele Service, or from your Miele dealer.

Making a coffee drink



- Place a cup under the main dispenser.
- Select a drink: Tap the sensor button for the drink you want. Or select a drink from the *Additional drinks* menu (*≡ sensor button).

Dispensing will start.

Canceling a drink

- To cancel making a drink, tap the drinks sensor or the *≡ sensor button for drinks from *Additional drinks* again.

Drink preparation will be canceled.

Tip: You can also cancel making a drink by tapping the *OK* sensor button as soon as *Stop* appears in the display.

When making **coffee with milk** or **2 portions of a drink** you can cancel each stage individually by tapping the **OK** sensor button.

2 portions (☐ sensor button)

You can dispense 2 portions of a drink into 1 large cup or into 2 cups at the same time.



- Place a cup under each of the main coffee dispenser spouts.
- Tap the ☐ sensor button immediately before or after you start making a drink.

The dispensing starts and 2 portions of the desired drink will be dispensed.

If, after a while, you have not tapped any of the drink buttons, the “2 portions” ☐ option will revert back to single portions.

Coffee pot

You can make several cups of coffee one after the other automatically with the **Coffee pot** function (max. 0.75 liter) to fill a coffee pot, for example. Up to 6 cups can be made in this way.

You can use the **Coffee pot** function twice in a row. After this, the coffee machine needs to cool down for one hour in order to prevent it from being damaged.

Make sure that the bean container and the water container have enough beans and water inside them before starting the **Coffee pot** function.

- Place a sufficiently large container under the main dispenser.
- Tap the '☐ sensor button.
- Select **Additional drinks | Coffee pot** and confirm with **OK**.
- Select the number of cups you want (3 through 6) and confirm with **OK**.
- Follow the instructions given in the display.

Each portion of coffee will be ground, brewed, and dispensed individually. You can follow the process on the display.

Canceling Coffee pot

- Tap the '☐ sensor button.

Coffee pot dispensing will stop.

Tip: A stainless steel coffee pot is available as an optional accessory from Miele for the “Coffee pot” function. The CJ JUG coffee pot is available to order from the Miele online shop, from Miele Technical Service, or from your Miele dealer.

Preparing beverages

Making coffee drinks from ground coffee

To make drinks using ready ground coffee, add a portion of ground coffee to the ground coffee chute.

This allows you to make a decaffeinated coffee even if the bean container is already filled with regular coffee beans, for example.

Only **1** portion of coffee or espresso can be made at a time when using ready ground coffee.

Place a **maximum of 0.4 oz (12 g) g** in the ground coffee chute.
If too much ground coffee is added, the brew unit will not be able to process the coffee.

Adding ground coffee

The coffee machine will use all the ground coffee that has been added to make the next coffee.

- Tap the ☰ sensor button.
- Select **Additional drinks | Ground coffee** and confirm with **OK**.

Add ground coffee and select drink **will** appear in the display.

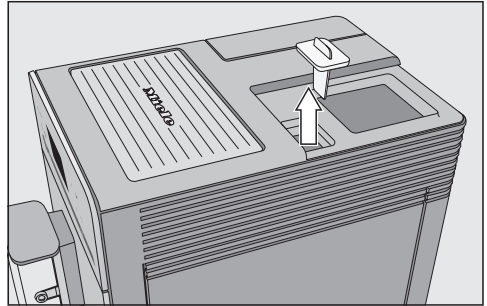

- First take the lid off of the coffee bean container and then take the cover off the ground coffee chute.
- Place a **maximum of 0.4 oz (12 g)** in the ground coffee chute.
- Replace the cover to the ground coffee chute after adding the ground coffee.
- Replace the lid on the coffee bean container.
- Place a cup under the main dispenser.
- Select a drink.

The coffee will now be made.

Dispensing hot water (CM 5410, CM 5510, CM 5710)

Please note that the water dispensed is not hot enough for making black tea.

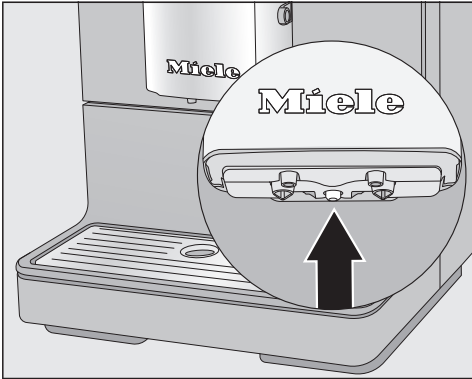

- Place a suitable container centrally underneath the main dispenser.
- Tap the ☰ sensor button.
- Select Additional drinks | Hot water and confirm with OK.

Hot water will run into the container under the main dispenser.

Grinder setting

The grinder setting determines the contact time between the ground coffee and the water, known as the extraction time. When the ideal grinder setting is selected, the machine dispenses a perfect cup of coffee with a fine, hazelnut-brown crema.

The grinder setting you select will be used for all coffee drinks.

There are various ways to tell whether the coffee grinder is set correctly.

The grinder setting is **too coarse** if the coffee or espresso is watery and tastes acidic. The crema is very pale.

Set a finer grinder setting.

The grinder setting is **too fine** if the coffee or espresso tastes too bitter and the crema is dark brown.

Set a coarser grinder setting.

Only adjust the grinder one setting at a time.

Start making a new drink to grind beans again. Adjust the grinder setting one setting at a time again.

- Open the service panel.

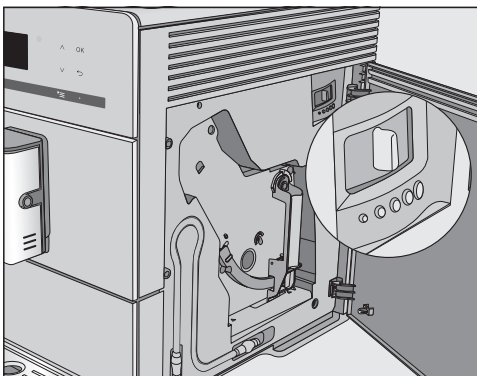

- Push the slide control one setting to the left (for finer grinding) or one setting to the right (for coarser grinding).
- Close the service panel.
- Make one cup of coffee.

After this, you can adjust the grinder setting again.

The altered grinder setting will not be used until after the second coffee has been dispensed.

Amount of coffee, brew temperature, and pre-brewing

You can set the amount of coffee, the brewing temperature, and pre-brewing for each drink individually. To do this, first select the drink from the Parameters menu and then adjust the drink parameters.

- Tap the '≡ sensor button and select Parameters.
- Select a drink and confirm with *OK*.

The current settings for the amount of coffee, brewing temperature, and pre-brewing will be displayed for this drink.

- Select Amount of coffee, Brew temperature, or Pre-brewing.
- Select the setting you want and confirm with *OK*.

The setting is now saved.

CM 5410, CM 5510, CM 5710: The changed parameter is always saved in the current profile. The name of the current profile is shown in the top left of the display.

Amount of coffee

The coffee machine can grind and brew 6–14 g of coffee beans per cup. The greater the amount, the stronger the coffee.

The amount of coffee is **too low** if the espresso or coffee lacks body.

Increase the amount of coffee so that more ground coffee is brewed.

The amount of coffee is **too high** if the espresso or coffee tastes bitter.

Decrease the amount of coffee so that less ground coffee is brewed.

Tip: If the coffee is too strong for you or it tastes bitter, try a different type of bean.

Brewing temperature

The brewing temperature must be adapted to the roast of the beans you are using. This is crucial whether you are making espresso or coffee.

Several types are sensitive to high brewing temperatures, resulting in an impaired taste. If your coffee tastes bitter, the brewing temperature you have selected might be too high.

Espresso is usually brewed at higher temperatures.

Pre-brewing ground coffee

When the pre-brewing function is turned on, the ground coffee is first moistened with a little hot water. The ground coffee swells a little. Then the remaining water is forced through the moistened coffee at high pressure. If your coffee tastes too bland and you want to add some spice and richness, try the “Pre-brewing” function. Depending on the type of coffee used, pre-brewing can intensify the taste.

You can set a short or long duration for pre-brewing or turn the “Pre-brewing” function off completely.

Tip: It is particularly recommended to use the “Pre-brewing” function to make coffee.

Portion size

The flavor of the coffee produced depends not only on the type of coffee, but also on the amount of water used. You can program the amount of water for all coffee drinks and hot water to suit the size of your cups and the type of coffee you are using. This does not alter the amount of coffee used.

For coffee drinks that use milk, you can also set the amount of milk or milk froth to be dispensed with these drinks, as well as the amount of coffee or espresso. Additionally, you can set the portion sizes for hot milk and milk froth alone.

A maximum portion size can be programmed for each type of drink. Dispensing stops once this has been reached. The maximum possible portion size is then saved by the appliance for this type of drink.

If the water container becomes empty while making a drink, the coffee machine will stop programming the portion size. The portion size will **not** be saved.

There are two ways of initiating the programming of the portion size:

- by touching the drink button when you are making a coffee, or
- by selecting **Portion size** in the **Parameters** menu.

CM 5410, CM 5510, CM 5710: The changed portion size is always saved in the current profile. The name of the current profile is shown in the top left of the display.

Canceling portion size programming

- Tap the drinks button again or the **☰** sensor button for drinks from Additional drinks.

Changing the portion size while making a drink

You can change and save the portion size for espresso ☐, coffee ☐, cappuccino ☐, and latte macchiato ☐ while making these drinks.

- Place a cup under the main dispenser.
- Tap the sensor button for the desired drink until **Change** appears in the display.

An audible tone will sound as soon as portion size programming starts. (As long as the volume has been set for the audible signals – see “Volume”.)

The desired drink will be made and **Save** will appear in the display.

- When the cup is filled up to the level you want, confirm with **OK**.

If you want to change the portion size for coffee with milk, the ingredients of the drink are saved one after the other during preparation.

- When the quantity for each ingredient reaches the level you want, confirm with **OK**.

The programmed mix of ingredients and the portion size will now be dispensed every time that particular drink is selected.

Changing the portion sizes in the Parameters menu

You can only change the portion sizes for **lungo**, **caffè latte**, **hot milk**, and **milk froth** via the Parameters menu.

- Place a suitable container under the main dispenser.
- Tap the '☰ sensor button and select Parameters.
- Select the drink you want.
- Select Portion size and confirm with *OK*.

Now proceed as for changing the portion size while making a drink.

Profiles

(CM 5410, CM 5510, CM 5710)

In addition to the Miele drinks menu (Miele profile), you can create individual profiles to cater for different tastes and preferences.

Within the profile, you can adjust the portion sizes and parameters individually for all drinks.

The name of the current profile is shown in the top left of the display.

Creating profiles

- Tap the '≡ sensor button and select Profiles. Confirm with *OK*.

The Profiles menu opens.

- Select Create profile.

The editor will open in the display.

- Enter the profile name:
 - To enter a character, highlight the one you want and confirm your choice with *OK*.
 - To delete a character, tap the ↵ sensor button.
 - To save the name, select the checkmark ✓ and confirm with *OK*.

The profile is created.

Changing drinks within a profile

When you change the parameters of a drink within a profile, these settings only apply to the active profile. The settings for drinks contained within other profiles remain unaffected.

- Select the profile you want.

The name of the selected profile is shown in the top left of the display.

You can now change the drinks individually.

Making drinks stored in a profile

- Place a suitable container under the main dispenser.
- Tap the '≡ sensor button and select Profiles.
- Select the profile you want and confirm with *OK*.
- Select the drink you want.

The machine starts dispensing the drink.

Changing the name

This selection is only possible if a profile has been allocated in addition to the Miele standard user profile.

- Use the arrow buttons ^ v to select Change name and tap *OK*.
- Proceed the same as with “Create profile”:
 - Select ↵ to delete a character.
 - To enter new characters, highlight the relevant character and confirm with *OK*,
 - Save the new name by selecting ✓ in the display and tapping *OK*.

Delete profile

This selection is only possible if a user profile has been allocated in addition to the Miele standard user profile.

- Select **Delete profile** and confirm with *OK*.
- Select the profile you wish to delete.
- Select *Yes* and confirm with *OK*.

The profile will be deleted.

Setting when the profile should change (Change profile)

You can choose between the following options:

- **Manually:** The selected profile will remain active until you select another one.
 - **After each use:** The machine will revert to the Miele profile whenever a drink is dispensed.
 - **When turned on:** The Miele profile will be displayed whenever the coffee machine is switched on, regardless of which profile was selected before the machine was last switched off.
- Select **Change profile** and confirm with *OK*.
 - Select the option you want and confirm with *OK*.

Settings

Displaying and changing Settings

The drinks menu is displayed.

- Tap the '☰ sensor button.
- Select **Settings** and confirm with *OK*.
- Select the menu option that you want to display or change.
- Confirm with *OK*.
- Change the setting as required and confirm with *OK*.

Language

You can select the language and, if applicable, your location for all display text.

Tip: If you select the wrong language by mistake, you can find the **Language** option again via the  symbol.

Timer: switch off after

If none of the keys have been pressed or no drink has been prepared, the coffee machine will turn itself off after 30 minutes to save energy.

You can change this pre-setting using the arrow buttons ∇/\wedge to a time between 15 minutes and 9 hours.

Eco mode

Eco Mode is an energy-saving mode. The system does not heat up until someone starts making a drink.

Eco mode is activated by default.

Info (display information)

You can display the number of drinks dispensed so far and how many more can be dispensed until the maintenance programs have to be run.

System lock

You can lock the coffee machine to prevent it from being used by unauthorized persons, such as children.

Temporarily deactivating the system lock

- Press and hold *OK* for 6 seconds.

The system lock is reactivated when the coffee machine is next switched off.

Water hardness

See “Water hardness” for more information.

Display brightness

Change the display brightness using the arrow keys \wedge/∇ .

Volume

The volume of the alarm and the sensor buttons can be set using the arrow buttons \wedge/∇ .

Tip: To switch off the tones, touch the arrow buttons ∇ until no more segments are filled in and **Turned off** appears.

Factory default settings

You can reset the coffee machine to its factory default settings.

The following will **not** be reset:

- The number of drinks dispensed and the appliance status (No. of portions until appliance needs descaling, ... brew unit needs degreasing)
- Language
- Profiles and the associated drinks (CM 5410, CM 5510, CM 5710)

Demo mode (showroom program)

Do not activate this setting for domestic use.

The Showroom program function enables the coffee machine to be demonstrated in stores or showrooms. Although the sensor buttons and display seem to be working, the thermo block is not being heated. The appliance does not dispense any drinks, run maintenance programs, or save any settings.

You can activate demo mode without commissioning the appliance. The water container is empty or not inserted. Switch the coffee machine on. As soon as the Fill and replace the water container message appears, touch the ↩ button for 5 seconds. Demo mode is activated.

Cleaning and care



Risk to health due to inadequate cleaning.

Heat and moisture inside the coffee machine can cause coffee residues to become moldy and/or milk residues to go off and pose a risk to health.

Carefully clean the coffee machine regularly.

Overview of cleaning intervals

Recommended frequency	What do I have to clean/maintain?
Daily (at the end of the day)	Water container
	Grounds container
	Drip tray and drip-tray cover
Once a week (more often if heavily soiled)	Main dispenser with integrated Cappuccinatore
	Brew unit
	Area underneath the brew unit and the drip tray
	Housing (particularly important immediately after descaling the appliance)
	Milk pipe
Once a month	Bean container and ground coffee chute
	Water container filter
When prompted	Degrease the brew unit (with 1 cleaning tablet)
	Descale the appliance (with 1 descaling tablet)

Clean by hand or in dishwasher

The brew unit is **not** dishwasher safe.

Only clean the brew unit by hand with warm water. **Do not use any cleaning agents.**

The following components must be cleaned **by hand only**:

- Main dispenser stainless steel cover
- Brew unit
- Bean container lid
- Lower panel

 Risk of damage as a result of excessively high dishwasher temperatures.

Components may be ruined (e.g., may become warped) if washed in a dishwasher at temperatures higher than 130°F (55°C).

For dishwasher-safe components, always select dishwasher programs with a maximum temperature of 130°F (55°C).

Contact with natural dyes, such as those found in carrots, tomatoes, and ketchup, may discolor the plastic parts in the dishwasher. This discoloration does not affect the stability of the parts.

The following parts are **dishwasher-safe**:

- Drip tray and lid
- Drip tray cover
- Waste unit
- Water container
- Main dispenser (without stainless steel cover)
- Ground coffee chute cover

Cleaning and care

 Danger of burning and scalding on hot components or by hot liquids. Components can become very hot during operation. Touching hot components can cause burning. The liquids and steam dispensed are very hot and can cause scalding.

Keep away from the area underneath the dispensers when hot liquids and steam are being dispensed.

Always allow the coffee machine to cool down before cleaning it.

Please be aware that water in the drip tray can also be very hot.

 Risk of damage due to moisture ingress.

The steam from a steam cleaning appliance could reach electrical components and cause a short circuit.

Do not use a steam cleaner to clean the coffee machine.

It is important to clean the appliance regularly. Milk residues can go off and can block the milk pipe.

Unsuitable cleaning agents

Contact with unsuitable cleaning agents can alter or discolor all surfaces. All surfaces are susceptible to scratching. Scratches on glass can in some circumstances lead to breakage.

Remove any residual cleaning agent immediately. Make sure you remove any spillages or splashes of descaling agent immediately.

To avoid damaging the surfaces of your appliance, do not use:

- cleaning agents containing soda, ammonia, acids, or chlorides
- solvent-based cleaning agents
- cleaning agents containing descaling agents (unsuitable for cleaning the housing)
- stainless steel cleaning agents
- dishwasher cleaners (unsuitable for cleaning the housing)
- glass cleaners
- cleaning agents for ceramic cooktops
- oven cleaners
- abrasive cleaning agents, such as scouring powder, scouring liquid, or pumice stones
- hard abrasive brushes or sponges, such as pot scourers or sponges which have been previously used with abrasive cleaning agents
- eraser sponges
- sharp metal scrapers
- steel wool or stainless-steel wire scourers

Grounds container, drip tray, and drip tray cover

Clean the drip tray and grounds container **every day** to avoid unpleasant smells and mildew.

The grounds container is located in the drip tray. Water from rinsing also collects in the grounds container.

A prompt will appear in the display when the drip tray and/or the grounds container is full and needs to be emptied. Empty the drip tray **and** the grounds container.



Danger of burning!

If the rinsing process has just finished, wait a while before removing the drip tray from the appliance. The water used for rinsing will continue to run out of the coffee machine spouts for a while.

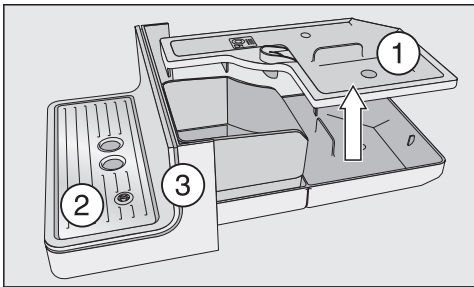

- Pull the drip tray carefully out of the coffee machine. Take the lid ① off.
- Empty the drip tray **and** grounds container.
- Remove the drip tray cover ② and the lower panel ③.
- Clean all parts thoroughly.

Clean the lower panel by hand only using warm water and liquid dish soap.

All other parts are dishwasher-safe.

- Clean the inside of the appliance underneath the drip tray.
- Reassemble all parts and place the drip tray back in the coffee machine.

Make sure the drip tray has been pushed into its niche as far as it will go.

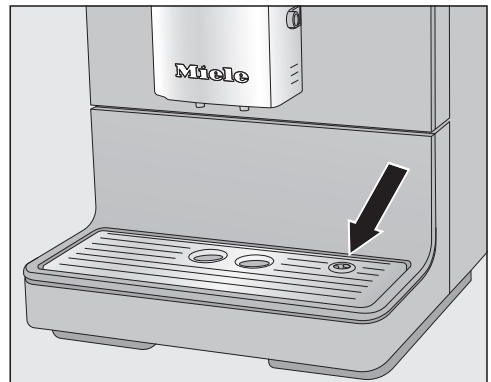

- Make sure that the drip tray cover is correctly fitted (see illustration).
- Clean the area under the coffee machine. Water can get under the appliance when the drip tray is removed.

Cleaning and care

Cleaning the water container

Clean the water container every day. You can clean the water container in the dishwasher once a week.

Make sure that the valve, the underside of the water container, and the surface the water container sits on are clean. Otherwise, the water container will not sit correctly.

- Remove the water container.
- The water container can be cleaned in the dishwasher, or by hand using warm water and liquid dish soap. Dry the water container after cleaning.
- Carefully clean and dry the surface the water container sits on in the coffee machine, particularly the recesses.
- Reinsert the water container.

Removing and cleaning the water container filter

Clean the water container filter once a month.

The water container filter is located under the water container.

- Remove the water container.

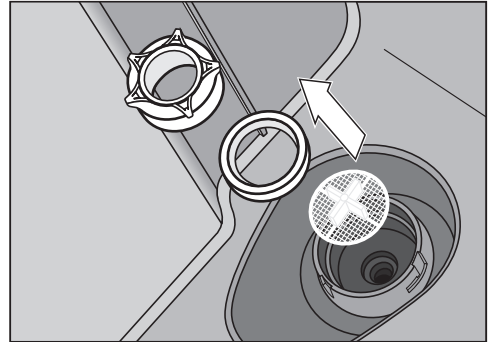

- Unscrew the cap. Remove the seal and the filter.
- Rinse all parts carefully under running water.
- Then replace the water container filter (with the cross facing upward) and then the seal. Finally screw the cap back on tightly.
- Replace the water container.

Main dispenser

Clean the main dispenser's stainless steel cover **by hand only**, using warm water and liquid dish soap.

All other parts are dishwasher-safe.

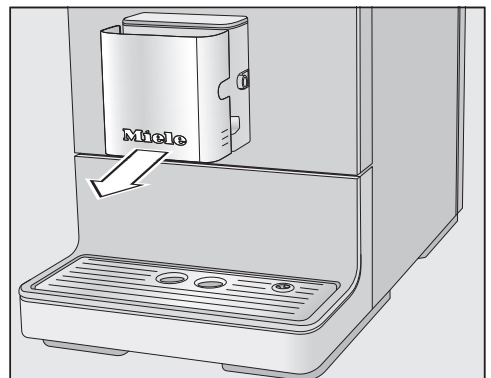

- Pull the stainless steel cover off.

Cleaning and care

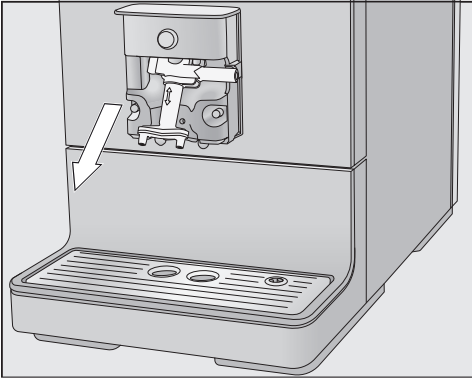

- Pull the dispensing unit down to remove it.

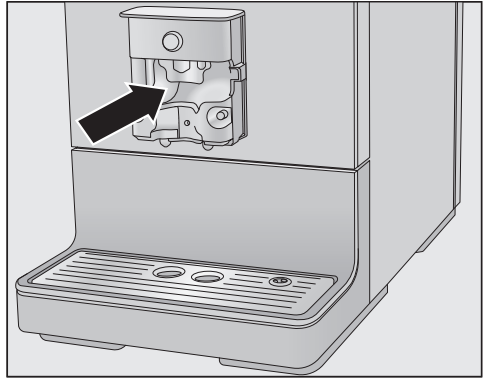

- Clean the surfaces of the main dispenser and the dispensing spouts with a damp cloth.

If the milk pipe connecting pieces are blocked, clean them under running water with the brush supplied:

- Insert the brush into the pipe connecting piece. Move it back and forth until all milk residue has been removed.

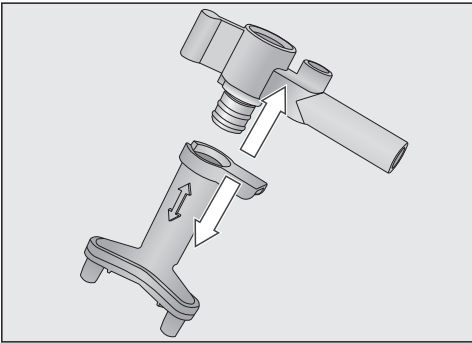

- Release the upper section with the holder for the milk pipe from the dispensing spouts.
- Clean all parts thoroughly.

If you have released the connecting piece from the milk pipe: when reassembling, ensure that the smaller, thinner end of the connecting piece is pushed into the hose.

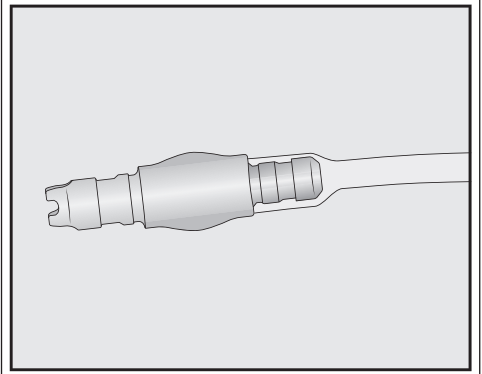

Cleaning and care

Reassembling the main dispenser

The dispensing unit is easier to reassemble if the individual parts are dampened with water beforehand.

- Reassemble the dispensing unit.
- Refit the dispensing unit onto the main dispenser. Press firmly to ensure the dispensing unit is securely fitted without any gaps.
- Replace the stainless steel cover and connect the milk pipe if required.

Milk pipe

 Risk to health due to inadequate cleaning.

Milk naturally contains bacteria. Heat and moisture inside the coffee machine can cause these bacteria to multiply, e.g., milk residues can go off and pose a risk to health.

Clean all components in which milk is transported thoroughly on a regular basis.

The milk pipe must be cleaned approx. every 5 days.

There are two options for cleaning the milk pipework:

- You can remove and dismantle the main dispenser with its integrated Cappuccinatore and either wash it in the dishwasher or by hand with warm water and liquid dish soap (see “Main dispenser with integrated Cappuccinatore”).
- Or you can clean the milk pipework using the Clean milk pipework maintenance program together with a cleaning agent for milk pipework (see “Maintenance programs – Cleaning the milk pipework”).

Tip: In addition to your weekly cleaning routine, we recommend carrying out the alternative cleaning procedure once a month. For example, if you manually clean the machine once a week, then you should run the Clean milk pipework maintenance program once a month. This combination will ensure that the milk pipework is cleaned optimally.

Bean container and ground coffee chute

 **Danger of injury from the grinder!**
Switch off and unplug the machine to disconnect the machine from the power supply before cleaning the bean container.

Coffee beans contain oils which can deposit on the walls of the bean container and hinder the flow of the beans. Therefore, clean the bean container regularly with a soft, dry cloth.

- Open the bean container.
- Remove any coffee beans.
- Clean the bean container with a dry, soft cloth.

The coffee bean container can now be refilled.

If necessary, clean the ground coffee chute:

- Open the ground coffee chute and remove any ground coffee residue.

Tip: Use a vacuum cleaner to remove any coffee residues from the bean container and the ground coffee chute.

Cleaning the casing

If soiling is allowed to stay for a long time or there is contact with unsuitable cleaning agents, surfaces can alter or discolor.

Remove any soiling immediately. Ensure that any splashes of descaling solution are wiped up immediately.

- Switch the coffee machine off.
- Clean the appliance front with a clean soft sponge and a solution of warm water and liquid dish soap. Then dry with a soft cloth.

Cleaning and care

Opening the Maintenance menu

You can find the maintenance programs in the Maintenance menu. Carry out the relevant maintenance program when the prompt to do so appears in the display.

- Tap the  sensor button.
- Select Maintenance and confirm with **OK**.

You can now select a maintenance program.

Rinsing the machine

If you have made a coffee drink, the coffee machine will rinse the coffee pipework automatically before switching off. You can also start the Rinse appliance function manually.

Rinsing the milk pipe

Milk residues can block the milk pipe. The milk pipe should therefore be rinsed regularly. If a drink has been made using milk, the prompt to insert the end of the milk pipe into the drip tray will appear at the latest when you switch the machine off.

You can also rinse the milk pipe manually.

- Tap the  sensor button.
- Select Maintenance | Rinse milk pipework and confirm with **OK**.

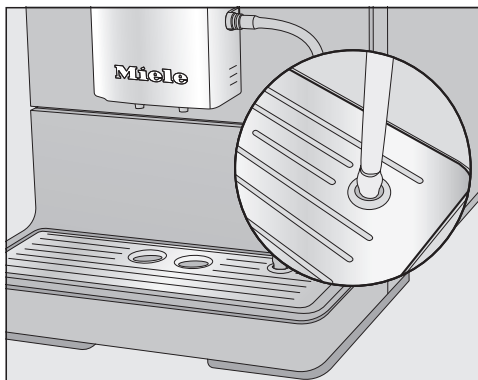

- When prompted, place the end of the milk pipe into the right-hand aperture in the drip tray.
- Confirm with **OK**.

The milk pipe will now be rinsed.

Cleaning the milk pipe with the maintenance program

For optimum cleaning results, it is recommended to use the Miele Cleaning Agent for milk pipes. The cleaning agent for milk pipes has been specially developed for use with Miele Coffee Machines and prevents subsequent damage.

It is available to order from the Miele online shop, from Miele Service, or from your Miele dealer.

The Clean milk pipework maintenance program lasts for approx. 10 minutes.

You need 1 stick of cleaning agent for milk pipes to clean the milk pipe.

- Tap the  sensor button.
- Select Maintenance | Clean milk pipework.

The cleaning process cannot be canceled. It must be completed through to the end.

- Confirm with *OK*.

The process will start.

- Follow the instructions in the display.

Place milk pipe in cleaning agent will appear in the display.

Making a cleaning solution:

- Dissolve the cleaning agent in a container with approx. 1 cup (200 ml) of lukewarm water. Stir the solution with a spoon until the powder has fully dissolved.

Carrying out the cleaning process:



- Place the container next to the machine and hang the milk pipe in the cleaning solution. Make sure that it is sufficiently immersed in the cleaning solution.
- Confirm with *OK*.
- Follow the additional instructions given in the display.

The cleaning process is complete when rinsing has finished.

Tip: Rinse any residual cleaning agent out of the milk pipe with running water.

Cleaning and care

Degreasing the brew unit and cleaning the interior

Depending on the natural oil content of the coffee used, the brew unit can become blocked quite quickly. It must be degreased regularly in order to ensure aromatic coffee and trouble-free operation of the coffee machine.

It is recommended to use Miele Cleaning Tablets to clean the brew unit. These have been specially developed for degreasing the brew unit in Miele Coffee Machines and prevent subsequent damage.

The cleaning tablets are available to order from the Miele online shop, from Miele Customer Service, or from your Miele dealer.

The maintenance program for degreasing the brew unit lasts for approx. 15 minutes.

You need 1 cleaning tablet for the maintenance program.

After 200 portions have been dispensed, a message prompting you to degrease the brew unit will appear in the display.

- Confirm the message with *OK*.

The message will appear at regular intervals. Once the maximum possible number of portions has been reached, the coffee machine will lock.

Degreasing the brew unit

No drinks can be made and *Degrease the brew unit and clean inside of the machine* appears in the display.

The cleaning process cannot be canceled. It must be completed through to the end.

- Confirm with *OK*.

The maintenance program will then start.

- Follow the instructions in the display.

Cleaning the brew unit and interior

Only clean the brew unit **by hand** with warm water. **Do not use any cleaning agents.** The moving parts of the brew unit are lubricated. Cleaning agents will damage the brew unit.

To ensure good tasting coffee and to prevent a build-up of bacteria in the machine, remove and clean the brew unit under running water once a week.

Rinse the brew unit by hand and clean inside the machine *will appear in the display*.

- Open the appliance door.

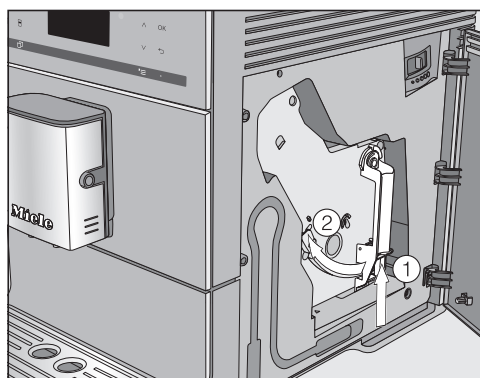

- Press and hold the button under the brew unit handle ① and, while doing so, turn the handle to the left ②.

Cleaning and care

- Carefully pull the brew unit out of the coffee machine.

Once you have removed the brew unit, do **not** change the position of the handle on the brew unit.

- Clean the brew unit **by hand under warm running water** without using cleaning agent or liquid dish soap.

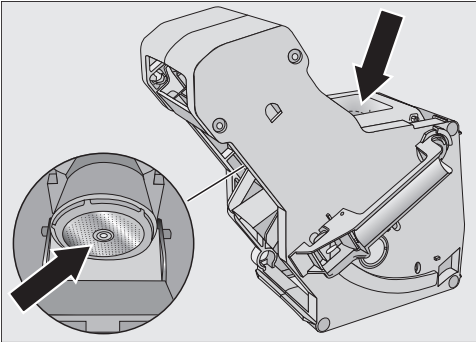

- Wipe any remaining coffee off the two filters (see arrows).
- Dry the funnel to prevent ground coffee from sticking to it the next time a coffee is made.

⚠ Risk to health due to inadequate cleaning.

Damp coffee residues in the interior of the machine can become moldy and pose a risk to health.

Remove coffee residues regularly and clean the interior of the machine.

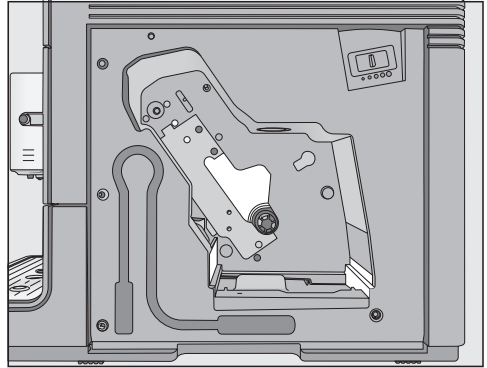

- Clean the interior of the coffee machine. Make sure that the areas highlighted in the illustration are cleaned especially well.

Tip: Use your vacuum cleaner to remove dry coffee grounds.

Place a cleaning tablet into the brew unit

Place a cleaning tablet in the brew unit, place it in the machine and close the machine door. **will appear in the display.**

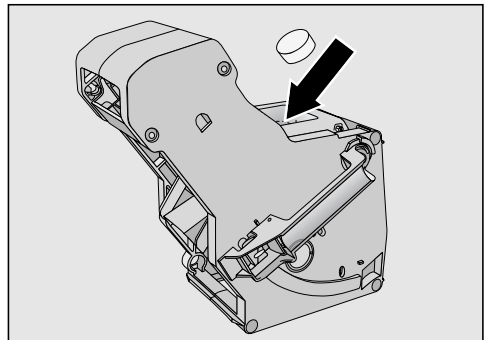

- Drop a cleaning tablet into the top of the brew unit (arrow).
- Push the brew unit containing the cleaning tablet back into the coffee machine.

Cleaning and care

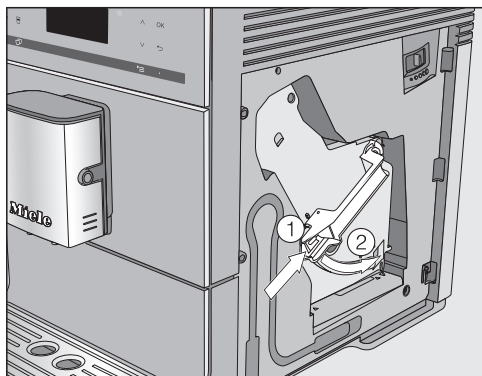

- Press the button on the end of the handle of the brew unit ① and while doing so turn the handle clockwise ②.
- Close the appliance door.
- Follow the additional instructions given in the display.

The cleaning process is complete when the drinks menu appears.

Descaling the appliance

Risk of damage from splashes from the descaling solution.
Sensitive surfaces and/or natural floors can suffer damage.
Wipe up any spillages immediately when descaling.

Limescale builds up in the coffee machine through use. How often the machine needs to be descaled will depend on the water hardness level in your area. Limescale must be removed regularly.

The machine will guide you through the descaling process. Various messages will appear in the display, e.g., you will be prompted to empty the drip tray or fill the water container.

Descaling **must be carried out**. The process takes approx. 15 minutes.

The coffee machine prompts you in the display when it needs to be descaled. No. of uses until appliance needs descaling; 50 will appear in the display. The remaining number of drinks that can be made before descaling will show in the display after each drink.

- Confirm the message with **OK**.

When the number of remaining portions reaches 0, the coffee machine will lock out.

You can switch the coffee machine off if you do not want to carry out the descaling program at this point. You cannot make any drinks until the machine has been descaled.

Descaling after prompt appears in the display

Descaling the appliance will appear in the display.

Descaling cannot be canceled once it has started. It must be completed through to the end.

- Confirm with *OK*.

The process will start.

- Follow the instructions in the display.

When Fill the water container with descaling agent and lukewarm water up to the descaling symbol  and place in appliance appears in the display, proceed as follows.

Preparing the descaling solution

For optimum descaling results, it is recommended to use the Miele Descaling Tablets.

The descaling tablets have been specially developed for Miele Coffee Machines.

Other descaling agents, which contain other acids besides citric acid and/or other undesirable substances, such as chlorides, may cause damage to the product. Moreover, the descaling result required cannot be guaranteed if the descaling solution was not of the appropriate concentration.

The descaling tablets are available to order from the Miele online shop, from Miele Customer Service, or from your Miele dealer.

You will need 1 descaling tablet to descale the machine.

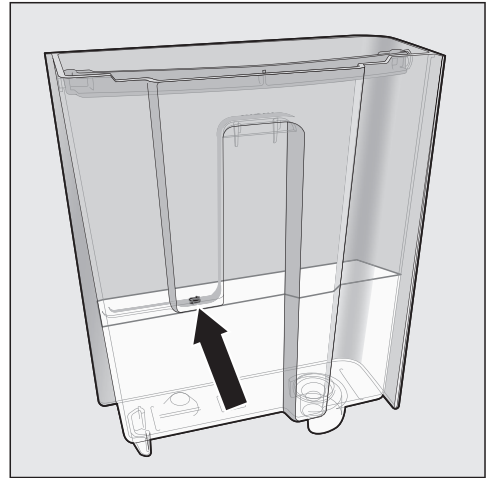



- Add 1 descaling tablet to the water container.
- Fill the water container to the  mark with lukewarm water.

Follow the instructions for the mixing ratio carefully. Fill the water container with the specified amount of water. Otherwise, descaling will be incomplete.

Carrying out descaling

- Reinsert the water container.
- Follow the additional instructions given in the display.

When Rinse the water container and fill with fresh tap water up to the descaling symbol  appears in the display:

- Remove the water container and rinse it thoroughly with clean water. Ensure that **no** descaling solution residue remains in the water container. Fill the water container to the  mark with fresh tap water.

Cleaning and care

The descaling process is complete when the drinks menu appears.



If the coffee system will not be used for an extended period of time, e.g. vacation, or will be transported over a long distance, the appliance should be prepared as follows.

- Empty and clean the coffee bean container
- Empty and clean the water reservoir
- Evaporating the coffee system
- Clean the interior of the machine
- Pack the machine securely

Evaporating the coffee machine

The coffee machine should be evaporated before it is stored for a long period of time or transported any distance – particularly at temperatures below freezing.

Evaporating the machine involves removing all traces of water from the system to prevent the risk of water and frost damage.

- Switch the coffee machine on with the On/Off  sensor button.
- Tap the  sensor button.
- Tap the  sensor button twice.

Empty the system? will appear in the display.

- Select Yes and confirm with *OK*.
- Follow the instructions in the display.

 Danger of burning and scalding at the dispensers.

Hot steam can cause scalding.

Keep away from the area underneath the dispensers when steam or hot liquids are being dispensed.

Do not touch hot components.

The evaporation process is finished when Program finished appears in the display and the display then goes out.

- Switch off the machine and remove the plug from the electrical outlet to disconnect the appliance from the power supply.
- Clean the drip tray and grounds container.

Packaging

The coffee system should only be packed when it is clean and dry. Residues of coffee grounds can cause scratches on surfaces. Coffee and milk residues or water can cause a build-up of bacteria.

Use the original packaging including Styrofoam to pack the coffee system.

Also pack the operating instructions so that they are available when the coffee system is next used.

Frequently Asked Questions

With the help of the following guide minor faults in the performance of the machine, some of which may result from incorrect operation, can be remedied without contacting the Service Department.



This guide may help you to find the reason for the fault, and how to correct it.

Messages in the display



Error messages must be confirmed with *OK*, otherwise the message may reappear in the display even though the problem has been remedied.

To address the fault, follow the instructions on the display.

If the error message appears in the display again, contact Miele Technical Service.

Problem	Possible cause and solution
F1, F2, F80, F82	There is an internal fault. <ul style="list-style-type: none">■ Switch the coffee machine off with the On/Off button . Wait for approximately one hour before switching the machine back on again.
F41, F42, F74, F77, F235, F236	There is an internal fault. <ul style="list-style-type: none">■ Switch the coffee machine off with the On/Off button . Wait for approximately 2 minutes before switching the machine back on again.
F10, F17	No water or very little water is being drawn in. <ul style="list-style-type: none">■ Remove the water container. Fill the water container with fresh tap water and reinsert the water container.■ Remove and clean the water container filter (see “Cleaning and care – Removing and cleaning the water container filter”).

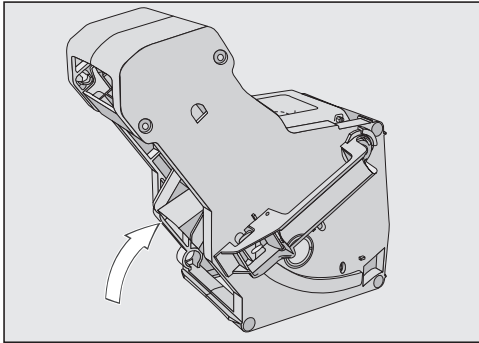
Frequently Asked Questions



Problem	Possible cause and solution
<p>F73 or Check the brew unit</p>	<p>The brew unit cannot be positioned correctly.</p> <ul style="list-style-type: none">■ Switch the coffee machine off with the On/Off button .■ Unplug the coffee machine. Wait for two minutes before inserting the electrical plug back in the socket.■ Remove the brew unit and rinse under running water.  <ul style="list-style-type: none">■ Push the coffee ejector of the brew unit into the correct position.■ Do not insert the brew unit. Close the service panel and switch the coffee machine on with the On/Off button . <p>This will initialize the brew unit motor and put it back into the start position.</p> <ul style="list-style-type: none">■ When Insert the brew unit appears in the display, put the brew unit back in the appliance. Close the service panel.

Frequently Asked Questions



Problem	Possible cause and solution
Too much ground coffee	<p>There is too much ground coffee in the ground coffee chute.</p> <p>The brew unit cannot compact ground coffee if more than two level spoonfuls of ground coffee are added to the coffee chute. The ground coffee will be emptied into the grounds container and the error message will appear in the display.</p> <ul style="list-style-type: none">■ Switch the coffee machine off with the On/Off button .■ Remove and clean the brew unit by hand (see “Degreasing the brew unit and cleaning the interior”).■ Remove the ground coffee inside the coffee machine, e.g., with a vacuum cleaner.■ Place a maximum of 12 g of coffee in the ground coffee chute.

Frequently Asked Questions

Unusual performance of the coffee system

Problem	Possible cause and solution
<p>The display remains dark when the coffee machine is turned on using the On/Off button .</p>	<p>The On/Off button  was not held for long enough.</p> <ul style="list-style-type: none"> ■ Tap and hold the On/Off button  for at least 3 seconds.
	<p>The electrical plug is not properly plugged into the socket.</p> <ul style="list-style-type: none"> ■ Insert the electrical plug into the socket.
	<p>The breaker has tripped because the coffee machine, voltage, or another appliance is defective.</p> <ul style="list-style-type: none"> ■ Unplug the coffee machine. ■ Contact a qualified electrician or Miele Service.
<p>The coffee machine turns off suddenly.</p>	<p>The factory-set switch-off time (20 minutes) or the switch-off time you have programmed has been reached.</p> <ul style="list-style-type: none"> ■ If required, you can select a new switch-off time (see “Settings – Timer”).
	<p>The plug is not properly plugged into the electrical socket.</p> <ul style="list-style-type: none"> ■ Insert the plug into the electrical socket.
<p>The sensor buttons do not respond. The machine can no longer be operated.</p>	<p>There is an internal fault.</p> <ul style="list-style-type: none"> ■ Disconnect power by unplugging the power cord from the electrical outlet and or switching off the circuit breaker.
<p>The display is hard to see or not legible.</p>	<p>The display brightness has been set too low.</p> <ul style="list-style-type: none"> ■ Change this setting (see “Settings”).

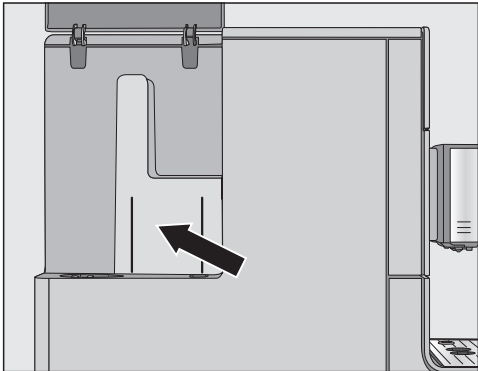
Frequently Asked Questions

Problem	Possible cause and solution
<p>The water container is empty. Fill and replace the water container has not appeared in the display.</p>	<p>Droplets of water have settled between the water container and the side walls of the housing, or this area is damp (see illustration).</p>  <ul style="list-style-type: none"> ■ Dry the surfaces. Take the water container out to refill it with water. <p>There is too much residual water on the inside walls of the water container, e.g., a biofilm has developed. Or the water container has a build-up of limescale.</p> <ul style="list-style-type: none"> ■ Clean the water container every day.
<p>Fill and replace the water container appears in the display even though the water container is full and in the machine.</p>	<p>The water container is not in the correct position.</p> <ul style="list-style-type: none"> ■ Remove the water container and push it back in again. <p>The water container was not correctly filled up and inserted during descaling.</p> <ul style="list-style-type: none"> ■ Fill the water container to the descaling mark[°]☞ and restart the descaling program.
<p>Fill and replace the water container appears after switching on even though the container is filled and installed in the machine. The appliance does not rinse.</p>	<p>The coffee machine needs descaling.</p> <ul style="list-style-type: none"> ■ Switch the coffee machine off with the On/Off button . Wait approx. one hour. ■ Switch the appliance back on again. As soon as PreHeating appears, tap the  sensor button and then select Descal the appliance. ■ Descal the coffee machine.

Frequently Asked Questions

Problem	Possible cause and solution
<p>After switching on the machine, the message Empty the drip tray and the waste container appears even though they are both empty.</p>	<p>This is not a fault. When the drip tray and grounds container are emptied, the internal counter is not reset after the coffee machine has been switched off. Empty the drip tray and the waste container appears in the display even though the drip tray and the grounds container are not filled to the maximum.</p>
<p>Neither milk nor milk froth comes out of the main dispenser.</p>	<p>The milk pipework is blocked.</p> <ul style="list-style-type: none"> ■ Clean the main dispenser, taking particular care to clean the Cappuccinatore and milk pipework carefully with the cleaning brush.
<p>Empty the drip tray and the waste container appears in the display, even though the drip tray has been emptied.</p>	<p>This is not a fault. The drip tray was not properly removed and/or replaced too quickly.</p>
<p>Insert the drip tray and the waste container appears in the display even though both are fitted.</p>	<p>The drip tray is not correctly fitted and is therefore not detected.</p> <ul style="list-style-type: none"> ■ Empty the drip tray and grounds container. Reassemble all parts and push the drip tray back as far as it will go in the coffee machine.
<p>The drip tray or the grounds container is too full or runs over although the drip tray and the grounds container were emptied after each message on the display.</p>	<p>This is not a fault. The drip tray and grounds container were probably removed or the appliance was opened without the drip tray and grounds container being emptied. When the drip tray is removed or the appliance opened, the internal counter for emptying the drip tray and grounds container is automatically reset.</p> <ul style="list-style-type: none"> ■ Remove the drip tray and grounds container from the appliance and empty them.

Frequently Asked Questions

Problem	Possible cause and solution
<p>Fill the bean container appears in the display even though the bean container has just been filled.</p>	<p>This is not a fault.</p> <ul style="list-style-type: none"> ■ Confirm the message with <i>OK</i>. <p>Insufficient coffee beans are getting into the grinder. Have you used a dark roast? This type of coffee bean is often oily. These oils can cling to the inside of the coffee bean container and hinder the flow of beans.</p> <ul style="list-style-type: none"> ■ Make a coffee and observe whether the coffee beans drop into the coffee bean container. ■ Clean the coffee bean container more often if you are using a darker, more oily bean. <p>Try other types of coffee bean which are less oily.</p>
<p>The coffee machine does not rinse itself when turned on.</p>	<p>This is not a fault.</p> <p>If the coffee machine is already at operating temperature, rinsing will not take place when the appliance is switched on.</p>
<p>Coffee dispensing is repeatedly interrupted and the message Fill the bean container appears in the display.</p>	<p>This is not a fault.</p> <p>The brew unit has not detected the ground coffee. Certain types of coffee produce a small amount of coffee when they are ground. Usually the grinder is set too fine and the amount is set to minimum.</p> <ul style="list-style-type: none"> ■ Confirm the message with <i>OK</i>. <p>If the coffee is too strong for you or tastes bitter, try a different type of coffee bean.</p> <p>If the display appears with all types of coffee:</p> <ul style="list-style-type: none"> ■ Set the grinder to a coarser setting (see “Grinder setting”). ■ Select a larger amount of coffee. <p>Don't forget to check any drinks changed in “User profiles”.</p> <p>If the message only appears when dispensing certain drinks:</p> <ul style="list-style-type: none"> ■ Check the amount of coffee set for this drink (see “Amount of coffee”). Select a larger amount of coffee. ■ You may also need to set a coarser grinder setting.

Frequently Asked Questions

Problem	Possible cause and solution
<p>The descaling process was started inadvertently.</p>	<p>The descaling program cannot be stopped once <i>OK</i> has been tapped. It must now be completed through to the end. This is a security setting to fully descale the coffee machine. It ensure a long service life and that your coffee machine is functioning correctly.</p> <ul style="list-style-type: none"> ■ Descale the coffee machine (see “Descaling the machine”).
<p>The milk sputters when it is dispensed. Hissing noises can be heard when milk is being heated up or frothed. Although the milk should be frothed, only hot milk comes out of the main dispenser.</p>	<p>The milk temperature is too high. Good milk froth can only be achieved when cold milk (below 50°F/10°C) is used.</p> <ul style="list-style-type: none"> ■ Check the temperature of the milk. <p>The main dispenser with integrated Cappuccinatore is not correctly fitted and is taking in air. Or the spouts are blocked.</p> <ul style="list-style-type: none"> ■ Check whether the main dispenser is correctly assembled. Make sure that all parts are tightly connected to one another. ■ If necessary, clean the main dispenser. <p>The milk pipework, connections, or the intake tube on the milk flask are blocked.</p> <ul style="list-style-type: none"> ■ Clean all parts thoroughly. <p>The steam jet on the main dispenser has a blockage.</p> <div data-bbox="400 1007 878 1350" style="text-align: center;"> </div> <div data-bbox="404 1358 1042 1445" style="border: 1px solid gray; padding: 5px; margin: 10px 0;"> <p>Push the cleaning brush a maximum of 1 cm into the steam jet.</p> </div> <ul style="list-style-type: none"> ■ Clean the steam jet with the cleaning brush.

Frequently Asked Questions

Problem	Possible cause and solution
<p>Coffee grounds have settled on the lid of the drip tray and in the interior around the brew unit.</p>	<p>This is not a fault. The movement of the brew unit during the brewing process can cause some ground coffee to fall around it. The type of beans used, the fineness of the ground coffee, and the amount of coffee ground also affect the amount. Important! Clean the interior of the coffee machine regularly to prevent bacteria, etc. Check whether the amount of coffee is set too high.</p>
<p>The underside of the coffee bean container cover is very damp. Drops of water are visible.</p>	<p>A large number of drinks have been made one after the other and the ground coffee chute is not closed or not properly closed. Steam has risen up from the brew unit via the ground coffee chute and condensed under the cover.</p> <ul style="list-style-type: none"> ■ Replace the lid on the ground coffee chute making sure it is properly sealed.
<p>Water from making coffee has collected on the benchtop underneath the coffee machine.</p>	<p>This is not a fault. Water can get under the appliance when the drip tray is removed. Clean the surface underneath the coffee machine regularly.</p>
<p>The display lights up but the coffee machine does not heat up and no drinks are made. The coffee machine cannot be turned off.</p>	<p>The Demo mode for demonstrating the coffee machine in stores and showrooms has been activated.</p> <ul style="list-style-type: none"> ■ Deactivate Demo mode.

Frequently Asked Questions

Unsatisfactory results

Problem	Possible cause and solution
<p>The coffee is not hot enough.</p>	<p>The cup has not been pre-heated. The smaller the cup and the thicker its walls, the more important it is to pre-heat it.</p> <ul style="list-style-type: none"> ■ Pre-heat the cup with hot water, for example.
	<p>The brewing temperature is set too low.</p> <ul style="list-style-type: none"> ■ Set a higher brewing temperature.
	<p>The filters in the brew unit are blocked.</p> <ul style="list-style-type: none"> ■ Remove the brew unit and clean it by hand. ■ Degrease the brew unit.
<p>Heating-up is taking longer. The amount of water is no longer correct and the coffee machine is not performing properly. Coffee flows into the cup very slowly.</p>	<p>The coffee machine needs to be descaled.</p> <ul style="list-style-type: none"> ■ Descale the coffee machine.
<p>Coffee is not flowing out of the main dispenser. Or coffee is only being dispensed via one spout.</p>	<p>The main dispenser has a blockage.</p> <ul style="list-style-type: none"> ■ Rinse the coffee pipework (see “Cleaning and care – Rinsing the appliance”). ■ If there is still no coffee coming out, or coffee is only coming out of one side, clean the dispensing spouts with the cleaning brush.
<p>The consistency of the milk froth is unsatisfactory.</p>	<p>The milk temperature is too high. Good milk froth can only be achieved when cold milk (below 50°F/10°C) is used.</p> <ul style="list-style-type: none"> ■ Check the temperature of the milk in the milk flask.
	<p>The milk pipe is blocked.</p> <ul style="list-style-type: none"> ■ Clean the main dispenser and milk pipework with the brush.

Frequently Asked Questions

Problem	Possible cause and solution
The coffee grinder makes a louder noise than usual.	<p>The coffee bean container has become empty during the grinding process.</p> <ul style="list-style-type: none">■ Fill the coffee bean container with fresh beans. <p>There may be foreign objects such as plastic or stones in amongst the coffee beans.</p> <ul style="list-style-type: none">■ Switch the coffee machine off immediately. Contact the Technical Service department.
The coffee flows too quickly into the cup.	<p>The grind level is too coarse.</p> <ul style="list-style-type: none">■ Set the grinder to a finer setting (see “Setting the coffee grinder”).
The coffee is dispensed too slowly into the cup.	<p>The brew unit is blocked.</p> <ul style="list-style-type: none">■ Degrease the brew unit (see “Cleaning and care – Degreasing the brew unit and cleaning the interior”).
The crema on the coffee or espresso is not as it should be.	<p>The coffee beans are no longer fresh. If roasted coffee beans are stored open for too long, the carbon dioxide gradually escapes from the coffee beans. The crema is no longer formed during dispensing.</p> <p>Of course, you can still use the coffee beans.</p>

Contact in the event of a fault

In the event of a fault which you cannot remedy yourself, please contact your Miele dealer or Miele Customer Service.

You can book a Miele Service Call online at www.miele.com/service.

Contact information for Miele Customer Service can be found at the end of this document.

Please quote the model identifier and serial number of your appliance (SN) when contacting Miele Customer Service. Both pieces of information can be found on the data plate.

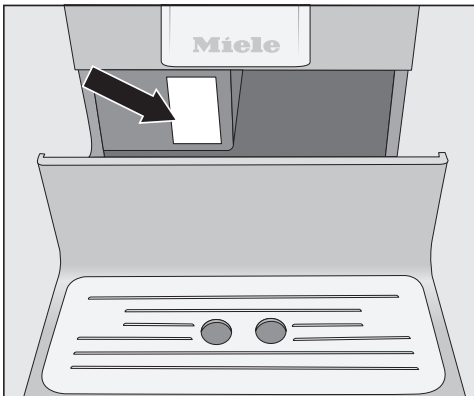

Appliance warranty and product registration

You can register your product and/or view the manufacturer's warranty terms and conditions for Miele appliances and vacuum cleaners at www.mieleusa.com.

Saving energy

The following tips can help you save energy and money as well as help the environment:

- Operate the coffee machine in “Eco mode” (default setting).
- Energy consumption may increase if you change the factory default settings for the timer.

This setting uses more energy will appear in the display.

- Switch the coffee machine off with the On/Off  sensor button when it is not in use.
- Change the setting for the “Switch off after” timer to 15 minutes. Then the coffee machine will switch off 15 minutes after the last drink has been made or a sensor button has been tapped.

Before connecting the coffee machine, make sure that the connection data on the data plate (voltage and frequency) matches the electrical supply. This data must match to avoid the risk of damage to the coffee machine. If in any doubt, consult a qualified electrician.

The connection data is provided on the data plate. The data plate can be found on the left-hand side of the appliance when the drip tray is pulled out.

The appliance is supplied with a power cord ready for connection to an AC 50 Hz 220–240 V supply.

The coffee machine must be connected to the power supply via a correctly installed safety socket outlet. The machine must be connected to an electrical system designed in accordance with national regulations.

The fuse rating must be at least 10 A.

The outlet should be next to the appliance and easily accessible where possible.

Do not connect the coffee machine to the power supply using a power bar or an extension lead. These do not guarantee the required safety of the appliance (risk of fire).

Do not connect the coffee machine to a **stand-alone inverter**. These devices are used for autonomous power supply, such as a solar power system. Power surges could cause a safety shut-off. This could damage the electronic.

The coffee machine must not be used with **energy saving plugs**. These reduce the energy supply to the machine, which could generate excessive heat.

If the power cord is faulty, it must only be replaced by a qualified electrician.

Installation

 Danger of overheating due to insufficient ventilation.

If the coffee machine is not sufficiently ventilated, the appliance can overheat.

Please ensure that there is adequate ventilation around the coffee machine.

Do not cover the coffee machine with dish towels, etc. while it is in use.

If the coffee machine is installed behind a closed cabinet front, heat and moisture can build up behind the cabinet front when closed. This can result in damage to the coffee machine and/or cabinetry.

Do not close the cabinet door while the coffee machine is in use.

Please observe the following installation instructions:

- The location of the appliance must be dry and well ventilated.
- The ambient temperature of the room in which the appliance is used must be between +50°F and +100°F (+10°C and +38°C).
- The coffee system must be set up on a level surface. The surface must be water resistant.

If the coffee machine is installed in a niche, the niche must provide the following minimum dimensions:

Height	20 1/16" (510 mm)
Width	17 11/16" (450 mm)
Depth	22 5/8" (575 mm)

When setting up the appliance: Make sure that the service panel can be fully opened so that the brew unit can be removed with ease when required.

- The coffee machine must be set up in the niche such that it sits flush with the front edge of the niche.

Appliance dimensions

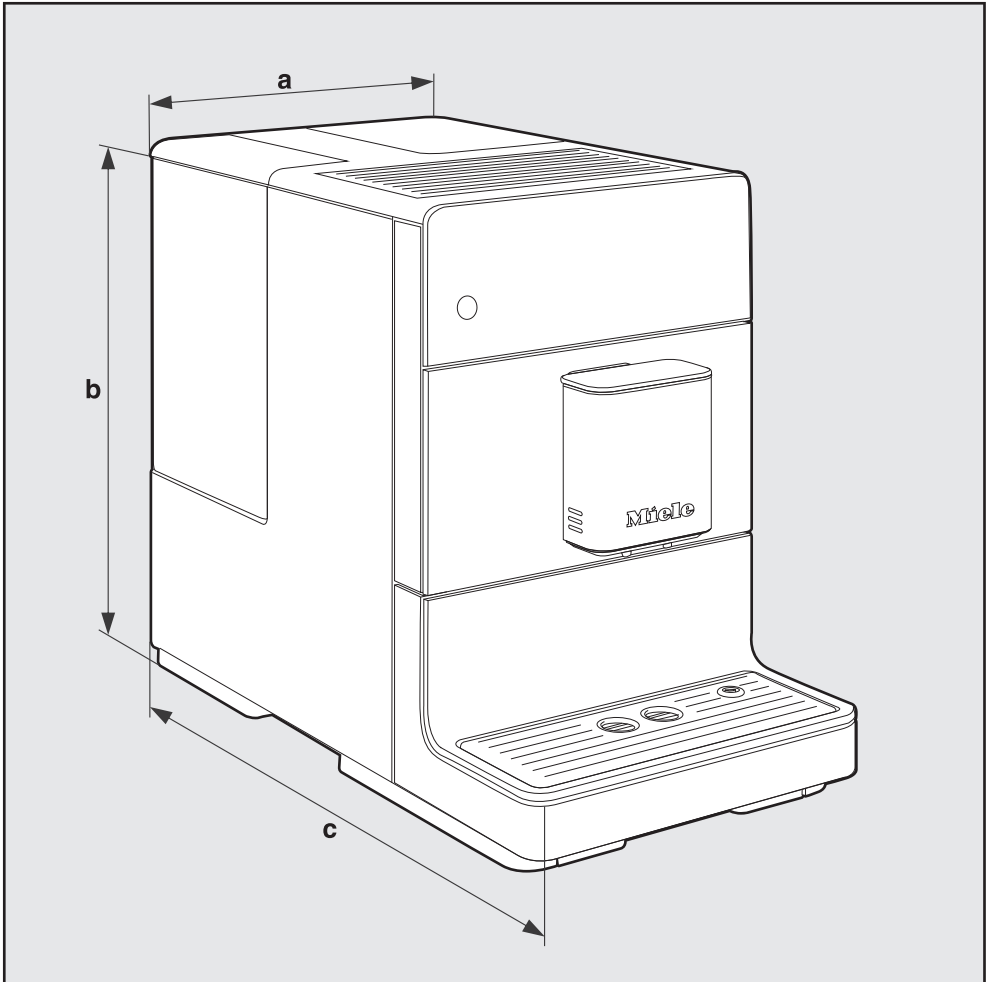

a = 9 1/2" (241 mm)

b = 14 3/16" (360 mm)

c = 18 1/8" (460 mm)

Technical data

Current draw in standby mode < 0.5 W
(default setting):

Pump pressure: max. 15 bar

Through-flow heater: 1 stainless steel thermo block

Dimensions (W x H x D): 9 1/2" x 14 3/16" x 18 1/8"
(241 x 360 x 460 mm)

Net weight: 21 lb (9.48 kg)

Power cord length: 3' 11 1/4" (120 cm)

Water container capacity: 4 1/4 c (1.3 l)

Bean container capacity: 0.44 lb (200 g)

Grounds container capacity: Max. 7 portions of coffee grounds

Main dispenser: Height adjustable between 3 1/8"-5 5/16"
(80–135 mm)

Grinder: Conical steel grinder

Grinder setting: Adjustable in 5 settings

Ground coffee amount: Max. 0.4 oz (12 g)

**Please have the model and serial number
of your appliance available when
contacting Customer Service.**

U.S.A.

Miele, Inc.

National Headquarters

9 Independence Way
Princeton, NJ 08540
www.mieleusa.com

Customer Support

Phone: 888-99-MIELE (64353)
info@mieleusa.com

International Headquarters

Miele & Cie. KG
Carl-Miele-Straße 29
33332 Gütersloh
Germany

Canada

**Importer
Miele Limited**

Headquarters and Miele Centre

161 Four Valley Drive
Vaughan, ON L4K 4V8
www.miele.ca

Customer Care Centre

Phone: 1-800-565-6435
905-532-2272
customercare@miele.ca

CM 5300, CM 5310, CM 5410, CM 5510, CM 5710