

# DONPER<sup>USA</sup>

## User Manual

### D250

Soft Serve Ice-Cream Machine

---

**ADDRESS:** 500 Stonegate Dr.  
Katy, TX 77494

**PHONE:** (844) 366-7371

---

# TABLE OF CONTENTS

- INTRODUCTION .....3**
- SAFETY SUMMARY .....4**
- SPECIFICATIONS .....5**
- QUICK START GUIDE .....6**
  - Installation and setup
  - Cleaning and Preparation
  - Operation
- INSTALLATION.....7**
- UNPACKING.....8**
  - Unpalletize Machine
  - Unpack and Inspect Parts
  - Routine Maintenance Operations:
- PRIOR TO OPERATING .....11**

**OPERATING .....12**  
Freezing the Product  
Standby/Night-Time Mode  
Standby/Night-Time Mode Details

**SETTINGS .....17**  
Hardness Setting  
Cup Counter  
Reset Cup Counter  
Wash Mode  
Advance Settings

**ADVANCED SETTINGS.....22**

Thanks for selecting the Donper D250 soft serve ice cream machine. The purpose of this manual is to provide you with the product specifications and our recommendations for effective and normal operation of this machine in order to ensure and guarantee the service life of this machine.

The Donper USA Model D250 soft serve machine is engineered and designed to provide dependable operation and a consistent, quality product:

- Two-flavor counter-top soft serve machine, with flavor-twist capability
- Independent digital controls for automatic regulation and customization
- Approved for dairy and nondairy products
- Hopper refrigeration to maintain product temperature below 40F (4C)
- Digital consistency-control system to adjust and maintain product consistency

This machine manual is intended to instruct users on the installation, operation, cleaning, and routine maintenance procedures. Information contained in this manual may be subject to change. Please check online or contact Donper USA Technical Support at 844-366-7371 for continued updates, training, and detailed information about your Donper USA machine.

# SAFETY SUMMARY

All safety regulations, local codes, and instructions that appear in the manual or on the equipment must be observed to ensure personal safety and to prevent damage to the machine. If equipment is used in a manner not specified by the manufacturer, the protection covered by the warranty will become null and void.

## ICONS FOUND THROUGHOUT THIS DOCUMENT AND WHAT THEY REPRESENT



**WARNING:** Risk of harm to the operator or machine if performed incorrectly.



**CAUTION:** Informs the operator of a task that may lead to harm if instructions are not followed.



**IMPORTANT:** Represents an extremely important step or note the user must be aware of.



**NOTE:** Non-hazardous, informational text.

# SPECIFICATIONS

| CAPACITY          |               |
|-------------------|---------------|
| Freezing Cylinder | 1.2 Qt (1.1L) |
| Hopper            | 4.8 Qt (4.5L) |
| Hourly Production | 15 Qt (14.2L) |

| ELECTRICAL  |        |
|-------------|--------|
| Voltage     | 115v   |
| Phase       | Single |
| Rated Input | 1500 W |

| DIMENSIONS |         |
|------------|---------|
| Height     | 27 in   |
| Width      | 16 in   |
| Depth      | 22 in   |
| Weight     | 168 lbs |

| REFRIGERANT |                    |
|-------------|--------------------|
| Refrigerant | R404a              |
| Compressor  | 1/2 HP             |
| Hertz       | 60hz               |
| Plug Type   | 115v Standard Plug |

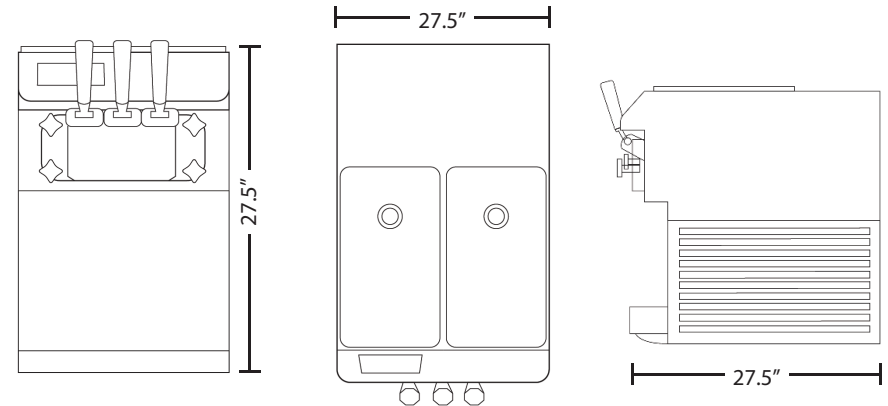

## INSTALLATION AND SETUP

1. Unpack and inspect machine, parts, and accessories.
2. Place machine in appropriate food preparation area. Comply with all installation requirements.
3. Read and understand ALL safety and standard operating procedures.

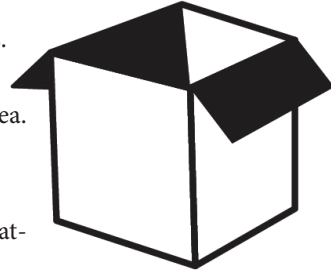

## CLEANING AND PREPARATION

1. Fully disassemble machine, and prepare parts for cleaning.
2. Thoroughly clean and scrub machine hoppers, cylinders, and all parts.
3. Lubricate and re-assemble all machine parts.
4. Fully sanitize machine.



## OPERATION

1. Prepare product in a separate container and ensure product is thoroughly mixed.
2. Add product to hoppers.
3. Turn machine to "AUTO" mode, and wait for product to reach desired frozen consistency.
4. Adjust the "HARDNESS" setting as necessary to reach the products desired consistency.



**CAUTION:** The machine must be placed on a level surface away from walls and other objects. Failure to comply will damage the machine and refrigeration components and will void all warranties.



**CAUTION:** The machine is designed to operate in normal ambient temperatures of 60-75°F. Operating in higher ambient temperatures will result in less than optimal performance.

1. Place on a flat, level, and solid surface fitted to the machine dimensions.
2. Ensure a minimum 6-inch clearance on all sides, front, and back.
3. Completely clear area of dust, grease, and airborne particles.
4. Place away from hot equipment such as stoves, fring baskets, ovens, etc.

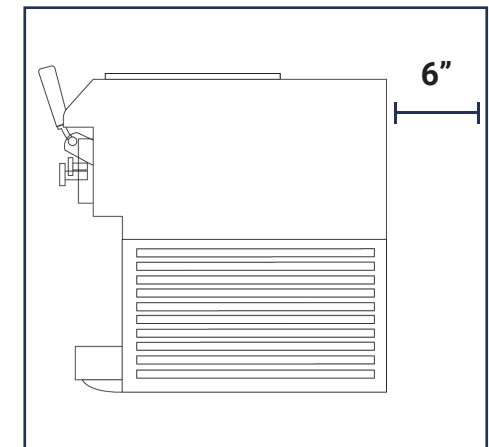
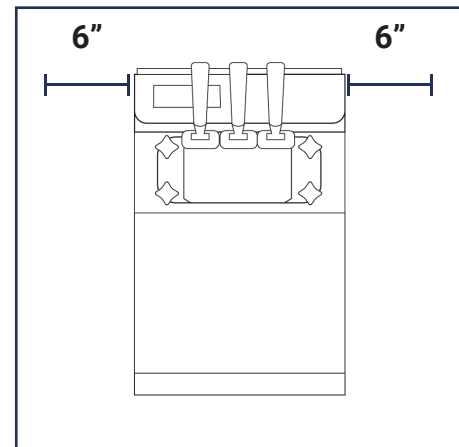

## UNPACKING



**WARNING:** Unpalletizing requires lifting. **Two or more personnel should remove the machine from its packaging and place it in its final operating location.** Failure to do so may result in severe injury or damage.

### UNPALLETIZE MACHINE

1. To remove all sides and cover of shipping box, unfold all tabs on the shipping box from their closed position to the open position using a flat-head screwdriver, and a hammer if needed.
2. Remove plastic wrapping from around the machine.
3. Being careful not to scratch or dent the machine panels, remove both side panels with a phillips-head electric screw driver.
4. On the bottom of the machine there are 2 stabilizing bolts securing the machine to the bottom of the shipping pallet/box. Using a #12 wrench and a #12 ratchet carefully remove both bolts.
5. Reattach both side panels using the phillips-head electric screw driver.



**CAUTION:** Do **NOT** over tighten the side panel screws as this could strip the plastic anchor points for the screws.

6. Prepare the area where the machine will be placed.
7. Place the machine in its final location according to the Installation Requirements

## UNPACKING

### UNPACK AND INSPECT PARTS

1. Remove all packaged parts and accessories from your machine.
2. Organize items on a clean table or operating area using the checklist below.

- Hopper Lids (2)
- Drip Tray (1)
- Drip Tray Cover (1)
- Spare Parts Kit
  - O-ring for Piston (4)
  - H-Seal (1)
  - Supporting Sleeve (2)
  - O-Ring for Dispenser Door(2)
  - Rear Seal (2)
- Food Grade Lube
- Feed Tube (2)
  - O-ring for feed Tube (4)
- Assembled Dispenser Door
  - Dispenser Door
  - Outer Draw Valve (2)
  - Middle Draw Valve (1)
  - O-ring for outer Draw Valve (4)
  - H-Seal (1)
  - Dispensing Handles (3)
  - Pin for Handles (1)
  - Supporting Sleeve (2)
  - O-Ring for Dispenser Door(2)
- User Manual

## UNPACKING

3. Inspect for damage immediately upon unpacking and call Donper USA Technical Service if you discover any damaged or missing parts.
4. Clean and properly lubricate machine parts prior to machine operation.

After unpacking and inspecting the parts, you are ready to disassemble the machine and prepare for the first operation.

## PRIOR TO OPERATING

After you have unpacked and set up your machine for use, we recommend running the “CLEAN” cycle for a few minutes with a mixture of 1-table spoon of bleach per gallon of water to ensure sanitization. Fill the freezing cylinder and hopper with this mixture then run “CLEAN” cycle for about 2 minutes. Dispense the water and repeat for best results.

For more information please visit our website [www.donperusa.com](http://www.donperusa.com) for instructional videos on how to adjust this setting.

### **MANUFACTURER RECOMMENDATIONS:**

For optimal machine performance and many years of efficiency and reliability from your machine, Donper USA recommends cleaning and sanitizing the machine and its parts daily.

- **REPLACE WEARABLE PARTS**                      Every 1 to 3 months
- **PREVENTATIVE MAINTENANCE**                      Every 3 Months



#### **CAUTION**

1. Do NOT run the machine without properly lubricating required parts
2. Do NOT clean the machine with abrasive or toxic chemicals and cleaners. Doing so may cause damage to the stainless steel material
3. NEVER use metal objects to clean the machine
4. ALWAYS replace wearable parts a minimum of every 3 months
5. ALWAYS inspect parts for excess wear and damage

# OPERATING

Operating the D250 is all done through the control board. On the control board there are 6 buttons, each of which has its own function. Pressing and holding different combinations of the buttons unlocks different settings which the user can adjust to fit their needs.



The symbols below will show up throughout this manual on images of the control board buttons. If you see one of these on a button, be sure to interact with the button according to the description.

SINGLE PRESS  
BUTTON



PRESS & HOLD  
BUTTON



## CONTROL PANEL

(L)

(R)

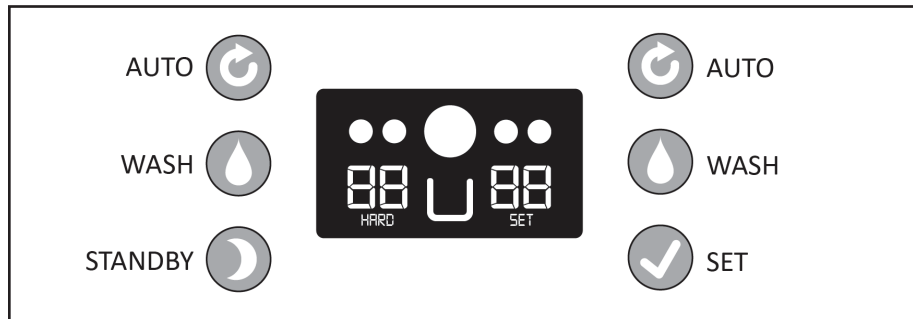

To operate the D250 control panel you first need to get the machine into "READY MODE" (this is when the machine is plugged into its power source and the power switch is in the ON position).

# OPERATING

## FREEZING THE PRODUCT

1. Verify machine has been recently sanitized (within 1 hour)
2. In a separate container, thoroughly mix and prepare product according to manufacturer instructions; mix should be cool and free of large chunks
3. Remove feed tubes in order for the mix to move into the freezing cylinder more quickly.
4. Pour product into hopper until freezing cylinders are full
5. Verify the freezing cylinder that you want to use is full of mixed product.

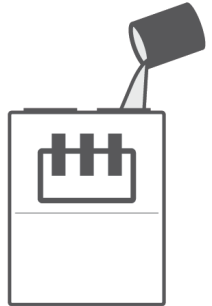

6. With the machine in ready mode, pressing the left "AUTO" button will begin freezing the left freezing cylinder and cooling the left hopper. Pressing the right "AUTO" button will begin freezing the right freezing cylinder and cooling the right hopper.

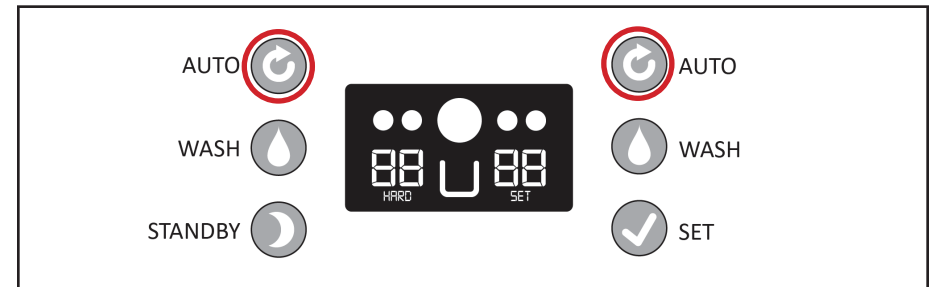

7. The number displayed on the left side of the control panel above the word "HARD" is the percentage of how ready the product currently is inside the left freezing cylinder based on its "HARDNESS SETTING".



## OPERATING

- The number displayed on the right side of the control panel above the word “SET” is the percentage of how ready the product currently is inside the right freezing cylinder based on its “HARDNESS SETTING”.



For example, when your mix is in its liquid form its hardness percentage will be closer 00. As it begins to freeze and change into its ice cream state, the percentage will begin to go up. Once the percentage reaches 99 the compressor will shut off and your ice cream is ready.

### EXAMPLE:

#### STILL FREEZING

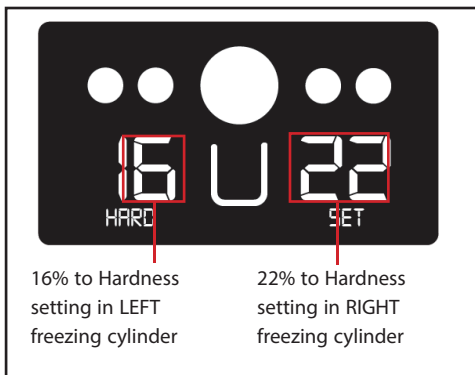

#### ICE CREAM READY

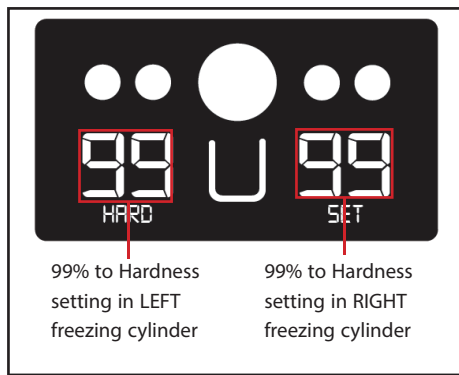

- With the product now ready to dispense, pull the draw valve handles to dispense the product. The side draw valve handles dispense product from their respective hoppers. The middle draw valve handle dispenses product from both hoppers to form a twist of the product.

If you find your product is not reaching the desired consistency you are looking for, you can adjust the “HARDNESS SETTING” (page.15) to make your product softer or more firm.

## OPERATING

### STANDBY/NIGHT-TIME MODE



When the machine will NOT be utilized for several hours, place it in STANDBY mode to conserve electricity and reduce product loss. While in STANDBY, the product in the freezing cylinders remains cold but may not be frozen. See STANDBY details for how the machine functions during STANDBY.

To enter “STANDBY” mode:

- Verify the machine is back in “READY MODE”. If either freezing cylinder is in “AUTO MODE” press the “AUTO” button for that side and the machine will return to “READY MODE”.
- Press the “STANDBY” button to enter “STANDBY MODE”.

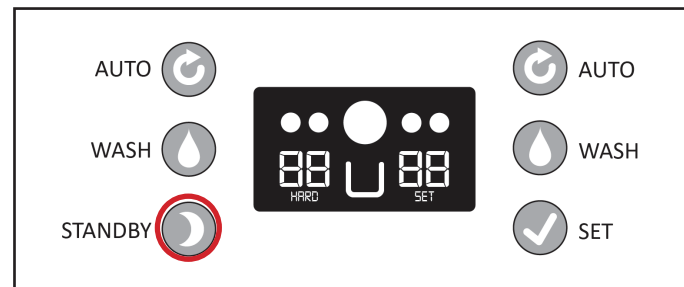

To EXIT “STANDBY” mode:

- Press the “STANDBY” button.

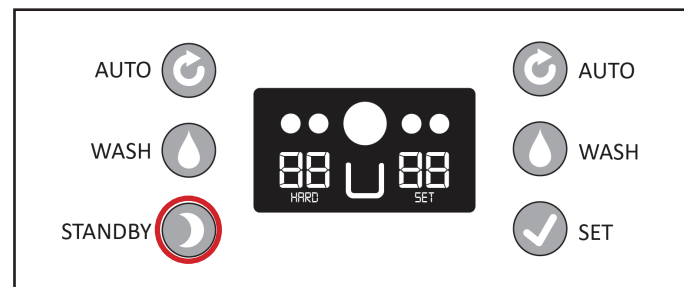

# OPERATING

## STANDBY/NIGHT-TIME MODE DETAILS

The following is a brief guide as to how the FREEZING CYLINDERS operate while your machine is in STANDBY MODE.

1. When the machine is placed into STANDBY MODE, the compressor and drive motor will power on.
2. The solenoid valves to the freezing cylinders will open and begin to freeze for 15 seconds and then close for 7 minutes repeatedly.



This cycle continues the entire time the machine is in "STANDBY".

3. The solenoid valves to the hoppers will open and close depending on the temperature of the mix inside the hoppers. When the temperature in the hoppers is above 20°C, the solenoid valve will remain open in order to continue cooling the hoppers.
4. Once the temperature inside the hoppers has dropped below 20°C, the solenoid valve will begin cycling, open for 30 seconds and closed for 7 minutes.



This cycle continues the entire time the machine is in "STANDBY", and the temperature in the hoppers is below 20°C.

# SETTINGS

## HARDNESS SETTING

**Hardness Setting** - this setting is referring to the consistency of your product. This setting ranges from "01" which is a softer/less frozen setting for your product and "10" which is a harder/more frozen setting for your product. The factory settings for the D250's hardness is set at "01". We find this setting seems to be ideal for most indoor installations.



**IMPORTANT:** Make only small adjustments to HARDNESS setting; allow at least 10 to 15 minutes between adjustments to evaluate product firmness. HARDNESS settings should not need continuous adjustment.

1. Press and HOLD the "SET" button for about 2 seconds. The numbers on the screen will begin to flash.

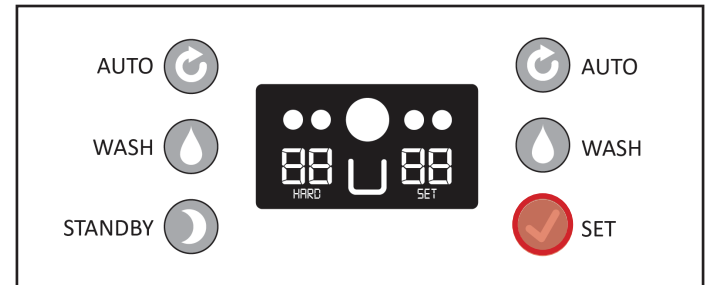

2. The number on the LEFT side of the screen is the current hardness setting for the LEFT freezing cylinder. The number on the RIGHT side of the screen is the current hardness setting for the RIGHT freezing cylinder.

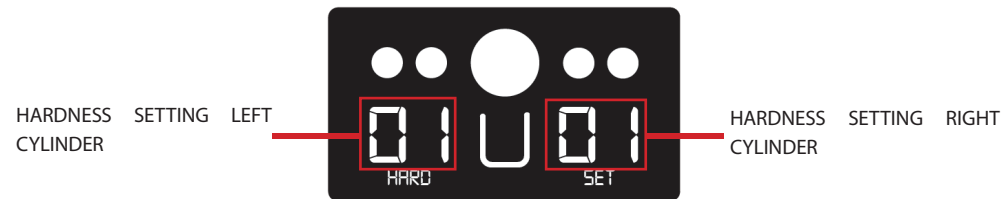

## SETTINGS

- To adjust the HARDNESS setting for the LEFT freezing cylinder, use the AUTO AND WASH buttons on the left side of the control panel. Pressing AUTO will increase the hardness and pressing WASH will decrease the hardness.

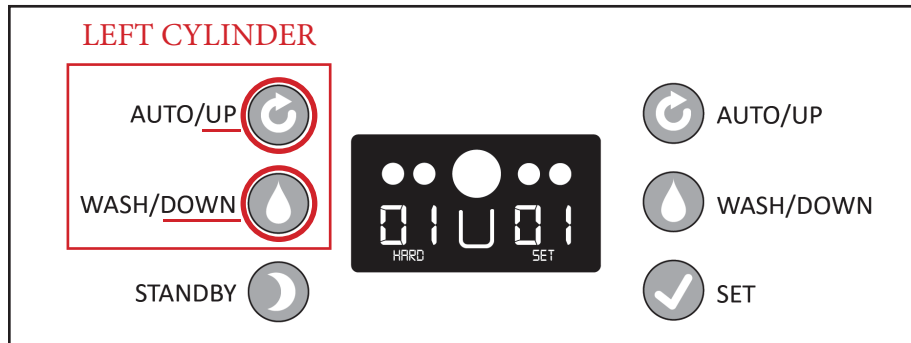

- To adjust the RIGHT freezing cylinder, use the AUTO and WASH buttons on the right side of the control panel. AUTO for UP and WASH for DOWN.

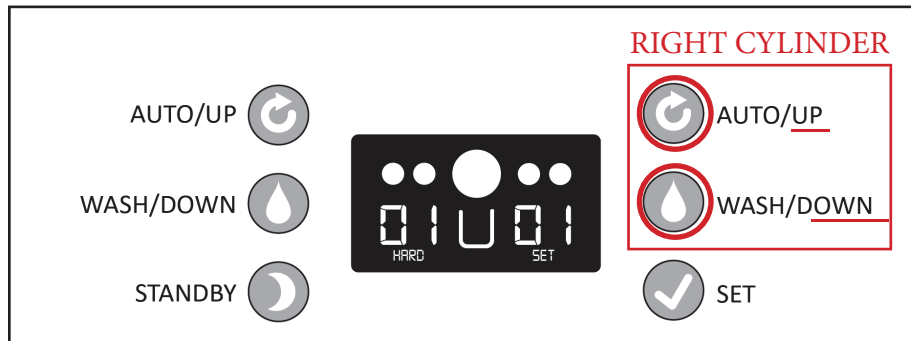

- Once you have made the adjustments, wait for about 5 seconds and values on the screen will stop flashing. The settings are now saved and your machine is back in “READY MODE”

## SETTINGS

### CUP COUNTER

The D250 has the ability to track the number of cups dispensed by the machine. To view this value simply do the following;

- Verify the machine is in “READY MODE”.
- Single press the “SET” button 1 time and the number of cups dispensed will display on the screen.

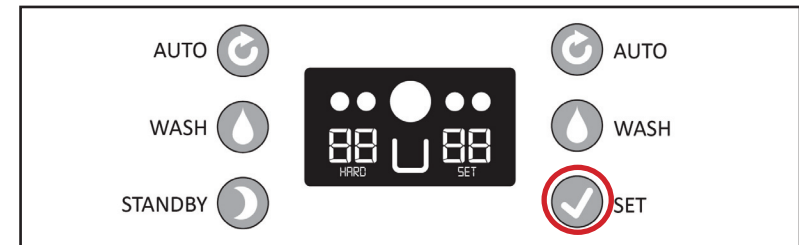

- Once the value is displayed, simply wait a few seconds and the screen will return to READY mode.

### RESET CUP COUNTER

- Verify the machine is in “READY MODE”.
- Single press the “SET” button 1 time and the number of cups dispensed will display on the screen.

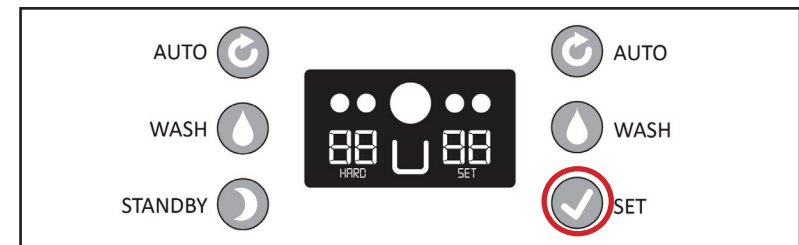

## SETTINGS

- While the CUP COUNTER value is being displayed, you have the option to reset this back to zero by pressing and holding the SET button for about 15 seconds.

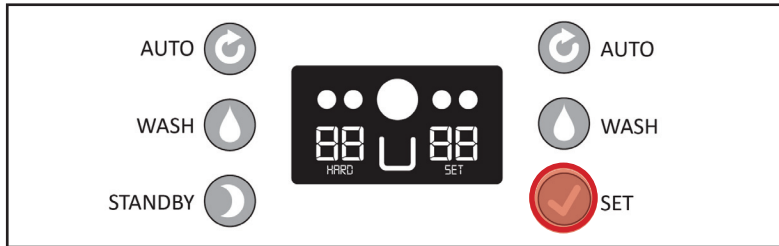

- The value on the screen will change to zero.
- Wait about 5 seconds and the machine will return to ready mode.

## WASH MODE



NOTE: When the machine is placed into WASH mode, the drive motor is active but the compressor is INACTIVE. This allows the augers in the freezing cylinder to rotate like normal, agitating anything that is inside the freezing cylinders without freezing.

- Verify the side of the machine you want to place into WASH mode is in READY mode.
- Press the WASH button on the side of the control panel. The corresponding side of the machine's drive motor will activate.

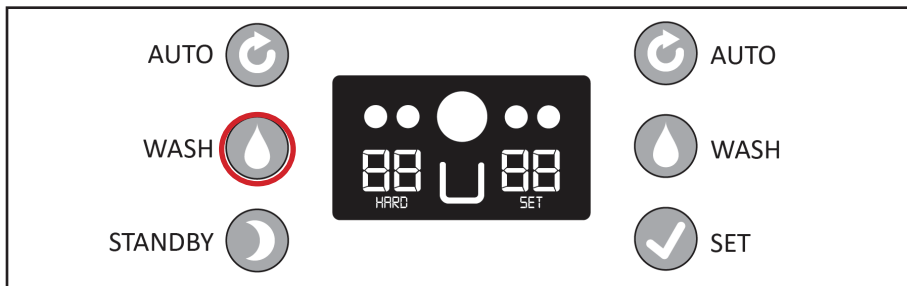

## SETTINGS

### EXITING WASH MODE

- Simply press the WASH button on the side of the machine which is currently in the WASH mode. (Left WASH button for the Left freezing cylinder and right wash button for the right freezing cylinder.)

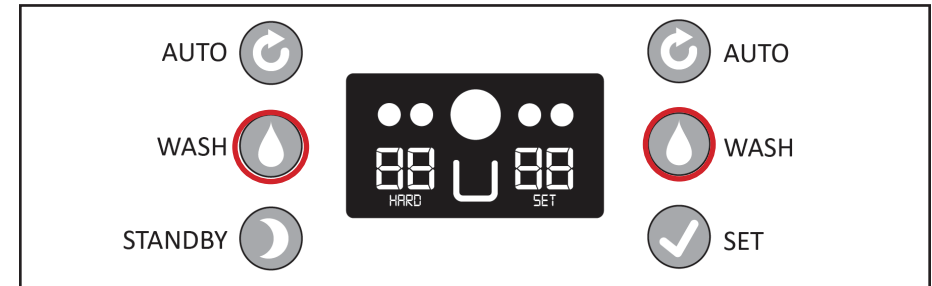

### ADVANCE SETTINGS



Accessing and adjusting these settings is only recommended after speaking with one of our qualified technicians. The only parameters that may need adjusting are the Hardness and Hopper Temp settings.

| ID | PARAMETER         | UNIT    | RANGE | FACTORY SETTING |
|----|-------------------|---------|-------|-----------------|
| P0 | Hardness          | 1       | 1-10  | 1               |
| P1 | Hopper Temp       | °C      | 1-8   | 3               |
| P2 | Cleaning Time     | Minutes | 1-30  | 15              |
| P3 | Periodic Restart  | Minutes | 5-15  | 5               |
| P4 | Drive Motor Delay | Seconds | 10-30 | 10              |

## ADVANCED SETTINGS

To access the ADVANCED SETTINGS confirm your machine is in READY MODE.

1. Press and hold the “SET” button for about 2 seconds until the numbers on the screen begin to flash, then release.
2. Press and hold the “SET” button again for about 5 seconds, until the flashing numbers change and display “P1” then release. You are now at the “P1” setting.

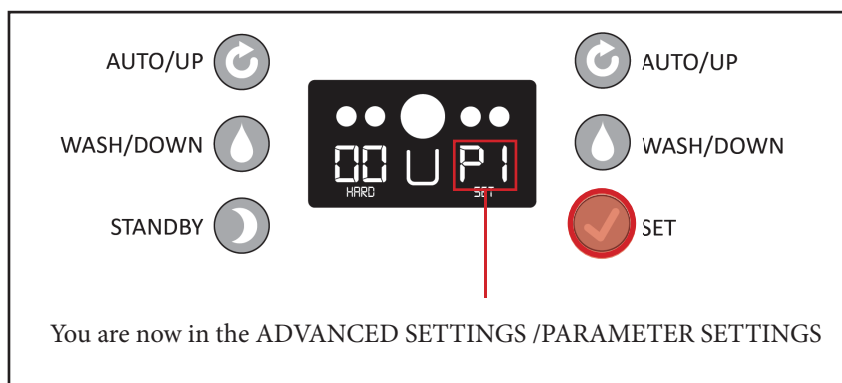

3. A single press of the “SET” button again and the P1 displayed will change to the number “03” which is the factory setting that P1 currently set to.

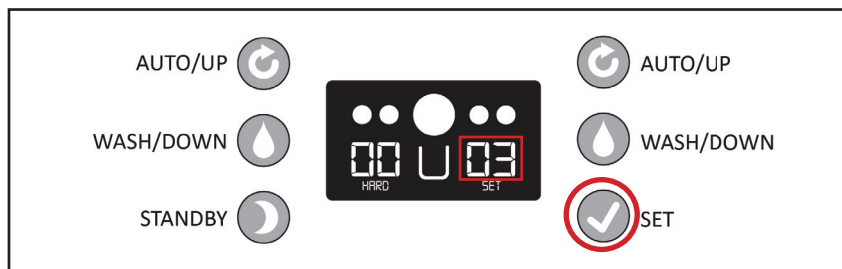

## ADVANCED SETTINGS



Continuing to SINGLE PRESS the SET button after “P1” has been displayed on the screen will scroll you through all of the parameters/“P” settings, first displaying the parameter ID then displaying the factory setting for that parameter.

4. Pressing the “AUTO” button will increase the setting 1 unit for each press.

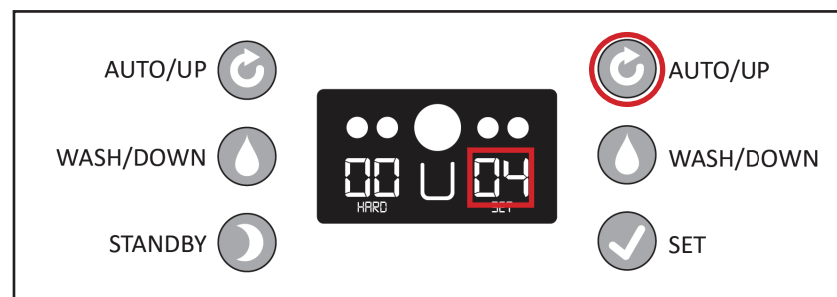

5. Pressing the “WASH” button will decrease the setting 1 unit for each press.
6. Once you have adjusted the value to your new desired setting, simply wait for about 10 seconds and the screen will return to ready mode and your setting will be saved.