



# Under Sink Water Filter

Owner's Manual



Claryum® 2-Stage



Claryum® 3-Stage



Claryum® 3-Stage Max Flow



Meet clean, healthy water. Your new Aquasana system features Claryum® filtration that removes up to 99% of 78 contaminants including microplastics, lead, PFOA/PFOS, pesticides, pharmaceuticals, and chlorine.\*

Enjoy the peace of mind that comes from knowing our award-winning filter technology is working for you.

---

AQ-5200, AQ-5300, AQ-5300+

# Under Sink Water Filter

## TABLE OF CONTENTS

Box Contents .....	1
Use & Care .....	2
Installation Steps.....	3-7
Filter Replacement.....	8-9
Performance & Certifications .....	10
Warranty .....	12
Water for Life® Program.....	13

*\*See Performance & Certifications (page 10+11) for specifics about contaminants reduced.*

### Faucet Assembly

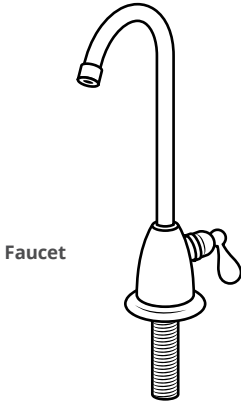

Faucet

Rubber Washer



Faucet Spacer



Lock Washer



Faucet Nut



Plastic Tube Insert



Plastic Collar



Chrome Nut



Poly Tubing

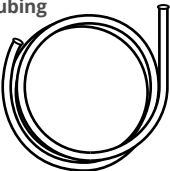

Brass Tube Insert



Plastic Collar



Brass Nut

Screws & Achors



Brass Tee

### AQ-5200 System with System Manifold, Filter Housings & Filters

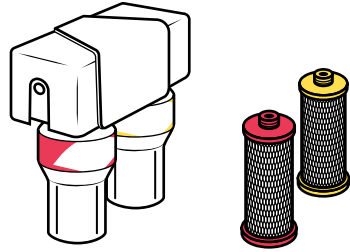

### AQ-5300 System with System Manifold, Filter Housings & Filters

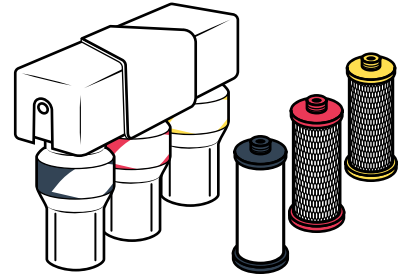

### AQ-5300+ System with System Manifold, Filter Housings & Filters

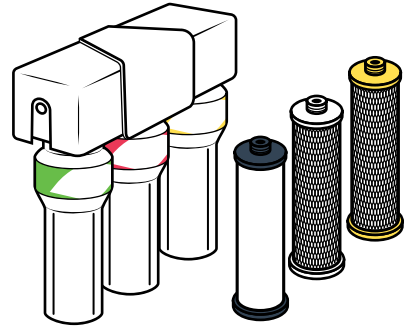

Before beginning installation, please ensure all parts listed are present.

If any part is missing or damaged, do not attempt to install the filter.

Please contact Customer Support for replacement parts at **866-662-6885**.

Please read all precautions and instructions carefully before using.

### Use and Care

- To clean your system, wipe down the exterior with a damp cloth.
- Do not use any strong or abrasive cleaning agent or solvent cleaner.

### Tools Recommended for Installation:

- Variable Speed Drill w/ 7/32" Bit
- Adjustable Wrench
- Philips Head Screwdriver
- Level
- Pencil
- Measuring Tape
- Bucket
- Hammer
- Safety Glasses

### NOTICE Important Safeguards

- Do not install this system where the line pressure may exceed 80 psi. The operating pressure range for this filter is between 20-80 psi.

- Install on COLD water lines only (40° - 90°F).
- Use caution when installing the system manifold on a cabinet wall that backs up to a dishwasher. Screws may exceed cabinet width.
- It is recommended that your system be installed inside and out of direct sunlight. The system must be protected from both direct sunlight and freezing temperatures.
- Filter usage must comply with all state and local laws.
- Do not operate without the filters installed.
- Must replace housing every 5 years or risk property damage from leaks. Call 866-662-6885 to order.
- Do not use with water that is microbiologically unsafe or of unknown water quality without adequate disinfection before or after the system.
- Systems certified for cyst reduction may be used on disinfected waters that may contain filterable cysts.

#### AQ-5200



Scan to view AQ-5200 product and installation videos.

#### AQ-5300



Scan to view AQ-5300 product and installation videos.

#### AQ-5300+

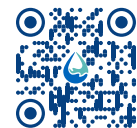

Scan to view AQ-5300+ product and installation videos.

This system requires a hole at least 1/2" (13mm) in diameter in the sink or countertop to install the supplied dedicated faucet. You may use a pre-existing hole, replace a kitchen sink sprayer or soap dispenser, or drill a new hole.

If you elect to drill a new hole for the dedicated faucet installation, we strongly recommend consulting a professional. Please wear safety glasses when drilling.

## 1 Setup

1. Unpack and unwrap box contents.
2. Turn off the cold water supply. Turn on the kitchen faucet to release pressure and allow water to drain from the line.
3. Disconnect the cold water supply using a wrench.

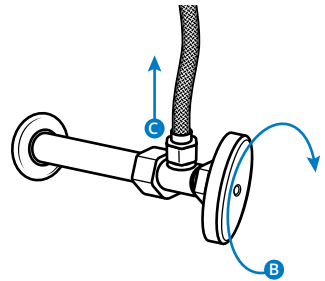

## 2 Attach Brass Tee and Tubing

1. Attach threaded ends of brass tee to the cold water supply line and shut-off valve. Tighten with wrench.
2. Attach white tubing to brass tee by sliding the compression nut onto white tubing with threads of the nut facing the end of the white tube.
3. Slide plastic sleeve onto the white tube. Place brass tee insert into the opening of the white tube. Push the tip of the white tubing into the opening of the brass tee. While holding the white tube in place, tighten the compression nut to compress the plastic sleeve and create a seal.

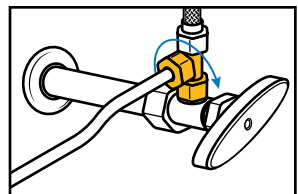
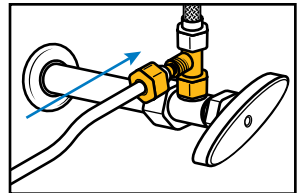
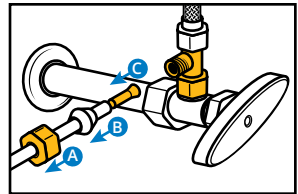

### 3 Assemble Dedicated Faucet

1. Slide rubber washer onto dedicated faucet and insert into drilled hole.
2. From underneath the sink, slide faucet spacer onto dedicated faucet.
3. Slide lock washer onto dedicated faucet.
4. Tighten faucet nut to secure faucet to sink.

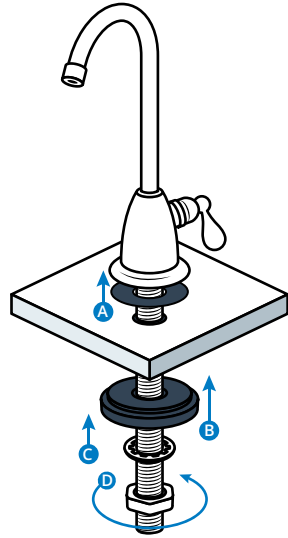

### 4 Connect Dedicated Faucet

1. Slide the chrome nut onto the poly tubing, followed by the white plastic collar.
2. Press the plastic tube insert into the end of the poly tubing.
3. Press the poly tubing against the faucet base, and slide the chrome nut and plastic collar up to the threads of the faucet. Use wrench to tighten.

**NOTE: Do not over tighten.**

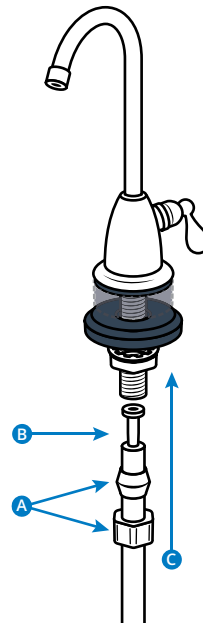

## 5 Install System Manifold

1. Select a location under the sink that is at least 12" from the bottom of the cabinet.
2. Use mounting holes located on the back of the system manifold to mark wall screw placements with pencil.  
AQ-5200: 65mm • AQ-5300: 98mm • AQ-5300+: 99mm
3. Use a 7/32" drill bit to drill holes for plastic anchors. Carefully tap the plastic anchors into the drilled hole with hammer.
4. Mount system manifold to the wall with screws.
5. Pull the protective plastic strip from battery compartment. LED will flash red and beep 5 times to indicate correct battery installation.

**NOTE:** Select a location that allows easy access to cold water supply and filter replacing.

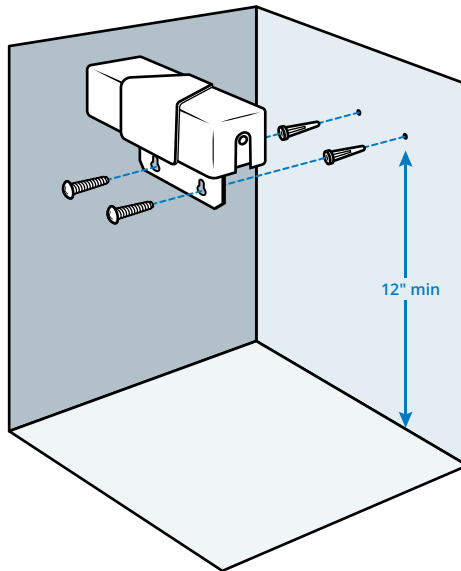

## 6 Attach Filter Housings

Reattach each filter housing to the bottom of the system manifold. Ensure connection points are correctly aligned, then push the filter housing up while turning clockwise. Continue this step for the additional filter housing(s). Ensure all filter housings are locked in place, are not on an angle, and are aligned as pictured. Improper placement may result in damage to the o-ring or leakage.

1. Attach first Claryum® filter housing (red).
2. Attach second Claryum® filter housing (yellow).
3. For AQ-5300: Attach Pre-Filter housing (black).
4. For AQ-5300+: Attach Pre-Filter housing (green).

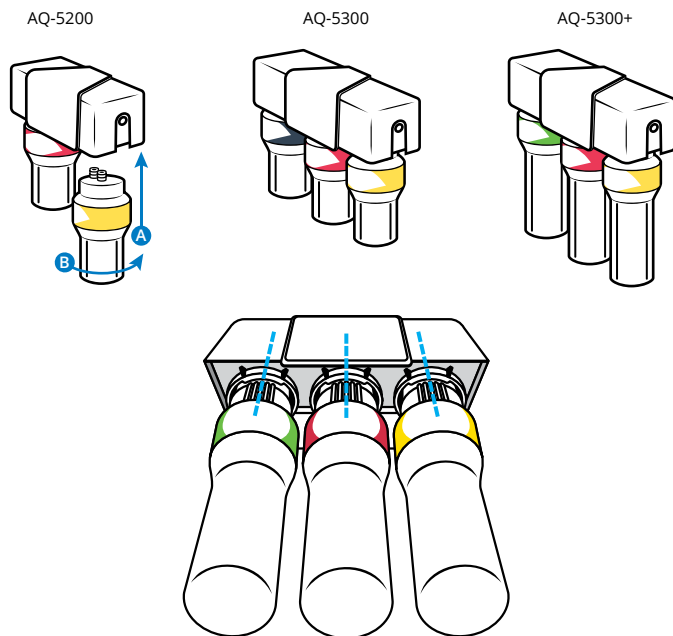

**NOTE:** Ensure all filter housings are attached and locked in place as pictured above. Ensure the filter housings are not on an angle while attaching. This may result in damage to the o-ring. Do not lubricate the o-rings.



## 7 Connect Water Supply Lines

1. Push the faucet tubing from the brass tee end into the inlet side (left side).
2. Push the tubing from the faucet side into the outlet side (right side).

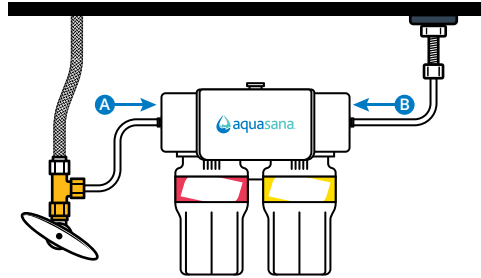

**NOTE:** Ensure tubing is completely inserted (to a minimum of 1") so leaking does not occur.

## 8 Flush System

1. Turn on cold water and check for leaks.
2. Flush water for 10 minutes to remove carbon fines.

**NOTE:** Do not drink flushed water.

Once filters are at 95% capacity (about every 6 months), the battery alarm will sound when water is flowing then will continue to sound for 15 seconds after water is turned off. The battery will need to be replaced every time the filters are replaced. A battery is included with the filter replacement cartridges.

1. Shut off the cold water valve under the sink. Release the pressure from the system by turning on the dedicated faucet. Once there is no longer any water flowing, you can proceed with replacing the filters.
2. Unbox filter replacements and remove plastic. Each filter is color coded to match the circle indicator on each filter housing.
3. Remove each filter housing from the system manifold by turning the filter housing to the left. Pull down to detach. Ensure the filter housing are not on an angle while removing. This may result in damage to the o-ring.
4. Holding the filter housing over the sink, open it by turning the bottom counterclockwise. Pour excess water down sink drain. Pull down on dirty filter to disconnect it from the filter housing. Continue this step for each filter housing. While the housing is open, inspect each o-ring for damage. If misaligned, gently move the o-ring into place.

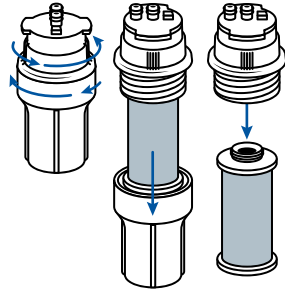
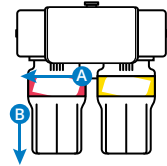

**NOTE:** If filter housing is too tight to disconnect by hand, please use the plastic wrench included with original system.

**NOTE:** The filter housing must be replaced every five years. Failure to do so could result in potential leaks due to product deterioration. To order, please call Customer Support at 866-662-6885.

- Press new replacement filter to the top of the filter housing using the appropriate color coded filters. Then, reconnect the bottom of the filter housing to the top half. Ensure connection points are correctly aligned, then turn clockwise to tighten. Continue this step for each filter housing.

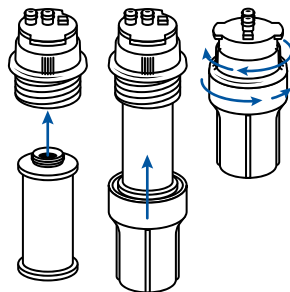

**NOTE: Do not use tools to tighten. Hand tighten only.**



- Reattach each filter housing to the bottom of the system manifold. Ensure connection points are correctly aligned, then push the filter housing up while turning clockwise. Continue this step for the additional filter housing(s). Ensure all filter housings are locked in place, are not on an angle, and are aligned as pictured. Improper placement may result in damage to the o-ring or leakage.

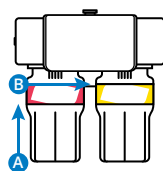

AQ-5200

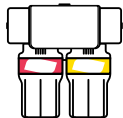

Red • Yellow

AQ-5300



Black • Red • Yellow

AQ-5300+

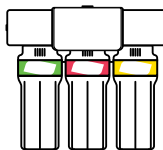

Green • Red • Yellow

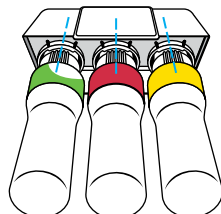

- Open battery door and remove old battery. Insert new battery. When inserted correctly, system will beep five times and blink red.
- Once all filter housings have been replaced and attached, slowly turn water valve on. Turn off faucet and inspect for leaks. Then, flush system for 10 minutes before drinking.

**NOTE: Do not drink flushed water.**

**AQ-5200R**



Scan to view AQ-5200R replacement video.

**AQ-5300R**



Scan to view AQ-5300R replacement video.

**AQ-5300+R**



Scan to view AQ-5300+R replacement video.

Model	Replacement	Rated Capacity
AQ-5200	AQ-5200R	500 gallons 1,892 liters
Operating Temp. Range	Operating Pressure Range	Service Flow
40-90° F 4.44-32.2° C	20-80 psi 137.89-551.58 kPa	0.5 gpm 1.9 lpm
<p><b>Manufactured by: Aquasana, Inc.</b>                      6310 Midway Road · Haltom City, Texas 76117                      866-662-6885</p>		



System tested and certified by WQA to NSF/ANSI Standards 42, 53, and 401 for the reduction of the claims specified on the Performance Data Sheet and at [www.WQA.org](http://www.WQA.org).

For the full list of contaminants filtered, scan to view the AQ-5200 Performance Data Sheet on [Aquasana.com](http://Aquasana.com).



Model	Replacement	Rated Capacity
AQ-5300	AQ-5300R	600 gallons 2,270 liters
Operating Temp. Range	Operating Pressure Range	Service Flow
40-90° F 4.44-32.2° C	20-80 psi 137.89-551.58 kPa	0.5 gpm 1.9 lpm
<p><b>Manufactured by: Aquasana, Inc.</b>                      6310 Midway Road · Haltom City, Texas 76117                      866-662-6885</p>		



C US

System tested and certified by WQA to NSF/ANSI Standards, 42, 53, and 401 for the reduction of the claims specified on the Performance Data Sheet and at [www.WQA.org](http://www.WQA.org).

For the full list of contaminants filtered, scan to view the AQ-5300 Performance Data Sheet on [Aquasana.com](http://Aquasana.com).



Model	Replacement	Rated Capacity
AQ-5300+	AQ-5300+R	800 gallons 3,028 liters
Operating Temp. Range	Operating Pressure Range	Service Flow
40-90° F 4.44-32.2° C	20-80 psi 137.89-551.58 kPa	0.72 gpm 2.7 lpm
<p><b>Manufactured by: Aquasana, Inc.</b>                      6310 Midway Road · Haltom City, Texas 76117                      866-662-6885</p>		



C US

System tested and certified by WQA to NSF/ANSI Standards, 42, 53, and 401 for the reduction of the claims specified on the Performance Data Sheet and at [www.WQA.org](http://www.WQA.org).

For the full list of contaminants filtered, scan to view the AQ-5300+ Performance Data Sheet on [Aquasana.com](http://Aquasana.com).





# Claryum® 2, 3, and 3+ Stage 1-Year Limited Warranty

## WHO IS COVERED

AQUASANA AND ITS SUPPLIERS, (herein collectively referred to as “Manufacturer”) warrants to the original owner who purchased and installed the system (hereinafter “Owner”).

## WHAT IS COVERED

This Warranty covers defects in materials or workmanship during the limited Warranty period of your of your Aquasana Water Filtration System including sub-components purchased with original system (may or may not include faucet and fittings), except as provided below. The water filter is warranted only when it is installed, operated and maintained in accordance with the instructions accompanying the water filter found on Aquasana.com. A water filter should be installed in such a manner that, if the system or any connection thereto should leak, the resulting flow of water will not cause damage to the area in which it is installed. For detailed instructions read the manual accompanying the water filter and review drawings in the manual.

## FOR HOW LONG

This Warranty runs for 12 months (365 days) from the date of purchase by a consumer (hereinafter “Warranty Period”). No Warranty coverage will be provided if the claimant is unable to provide proof of purchase from an authorized Aquasana reseller. Estimated lifespan of products is for information only and is based on usage approximations. Water conditions and use rates may limit the functional lifespan of your filter. This Limited Warranty does not extend to the full estimated life span of the system.

## WHAT AQUASANA WILL DO

1. If necessary, the Manufacturer will provide a replacement that fulfills the remaining estimated lifespan/capacity of your original purchase and send it to you with installation instructions. If industry standards, product improvements or product obsolescence prohibit Manufacturer from furnishing an identical model replacement water filter under this Warranty, the Owner will be furnished with a new water filter of comparable remaining capacity and functionality; however, the Owner will be charged for the additional value of the item(s) which Manufacturer has incorporated in the replacement water filter. The Warranty period for any replacement will run for the balance of the original 365 days.
2. Component Part – If any component part proves to Manufacturer’s satisfaction to be defective in material or workmanship within the Warranty period listed on the data plate label, the Manufacturer will furnish the Owner with a replacement for the defective part(s).
3. Return of Defective Water Filter and Component Parts – Manufacturer reserves the right to examine the alleged defect in the water filter or component part(s), and it will be the Owner’s obligation to return the water filter and/or component part(s) to the Manufacturer at the Manufacturer’s request.
  - a. When returning a water filter, it must include all component parts.
  - b. When returning component part(s), they must be individually tagged and identified with the water filter’s model number, date of purchase, and date of installation.

## WHAT IS NOT COVERED

1. This Warranty does not cover filter cartridges and any systems that were not installed in compliance with the instructions or that have been abused or operated incorrectly.
2. This Warranty applies only to products purchased from authorized Aquasana resellers.
3. The Limited Warranty stated herein is in lieu of any and all warranties, express or implied (whether written or oral), including, but not limited to, the implied warranties of merchantability and fitness for a particular purpose.
4. Manufacturer shall not be liable for any incidental, consequential, special, punitive, or contingent damages or expenses, arising, directly or indirectly, from any defect in the water filter or the use of the water filter, including but not limited to water damage.
5. Manufacturer shall not be liable for any water damage arising, directly or indirectly, from any defect in the water filter or component part(s) or from its use.

6. Manufacturer shall not be liable for any damage or product failures caused by any of the following:

- The water filter or any of its component parts have been subject to misuse, alteration, neglect or accident.
  - The water filter has not been installed in accordance with the applicable local plumbing and/or building code(s) and/or regulations or in their absence.
  - The water filter is not installed, operated and maintained in accordance with the printed Manufacturer’s instructions, including if the water filter has any additional aftermarket equipment introduced into the sealed system not approved by the manufacturer.
  - The water filter is exposed to highly corrosive conditions.
  - The water filter is not continuously supplied with potable water.
  - The water filter is not operated within the factory calibrated temperature limits.
  - The water filter is installed in direct sunlight or exposed to freezing temperatures.
  - The water filter or any of its component parts fail due to sediment build-up.
  - Clogging due to purchaser’s failure to replace the filter cartridges.
  - Damage caused by fire, flood or acts of God.
  - Damage caused by over-pressurization in the water line.
7. Manufacturer shall not be liable for any claims related to excessive noise, smell, or taste of water.
  8. This Warranty does not cover damage caused by the use of parts that are not genuine Aquasana parts. This includes, but is not limited to replacement filters, faucets, and/or diverter valves.
  9. Except when specifically prohibited by the applicable state law, the Owner, and not the Manufacturer, shall be liable for and shall pay for all charges for labor or other expenses incurred in the removal, repair or replacement of the water filter or any component part(s) claimed to be defective or any expense incurred to remedy any defect in the product. Such charges may include, but are not necessarily limited to:
    - a. All freight, shipping, handling and delivery costs of forwarding a new water filter or replacement part(s) to the owner.
    - b. All costs necessary or incidental in removing the defective water filter or component part(s) and installing a new water filter or component part(s).
    - c. Any material required to complete, and/or permits required for, installation of a new water filter or replacement part(s), and
    - d. All costs necessary or incidental in returning the defective water filter or component part(s) to a location designated by the Manufacturer.

## HOW TO GET SERVICE

To receive service under this Warranty, you must contact Aquasana (A. O. Smith Water Treatment (North America), Inc.) at 1-866-662-6885 or warranty@aquasana.com within the Warranty Period to describe the problem to a customer service representative who will verify that the product is under Warranty and determine whether a part or the system will be replaced and whether you must send back the unit. You will be required to provide proof of purchase from an authorized Aquasana reseller and proof of proper installation.

## WARRANTY REGISTRATION

Warranty registration is not required for coverage under the Aquasana Limited Warranty and is not necessary for factory direct purchases made from [www.aquasana.com](http://www.aquasana.com). If you purchased from a retailer or an authorized reseller, please complete the online Warranty registration form at [www.aquasana.com/warranty](http://www.aquasana.com/warranty). Proof of purchase from an Aquasana authorized dealer is required. Once registered online, we will have a record of your purchase.

## HOW STATE LAW APPLIES

This Warranty gives you specific rights and you may have other rights which vary from state to state. Some states do not allow the exclusion or limitation of incidental or consequential damages, so the above limitation or exclusion may not apply to you.



# water for life®

## Protect your investment and save money with Water for Life®.

Our Water for Life® program helps you protect the investment you've made in your family's health with an extended limited warranty on your new filtration system, a 15% discount on replacement filters, and free shipping.



### Extended Limited Warranty

Our performance promise to you – free replacement parts when needed.\*



### Discounted Replacements

The only way to lock in a 15% discount on replacement filters.



### Free Shipping

Replacements shipped to you right when you need them – at no extra cost.



### No Contract

Free to join and cancel anytime – no long-term commitment required.

## CONTACT US TO LEARN MORE



866-662-6885



[waterforlife@aquasana.com](mailto:waterforlife@aquasana.com)

\*Exclusions apply. Limited Warranty details are available at [aquasana.com](http://aquasana.com). Benefits are for the term of Water for Life membership.



### LOVE IT?

Please let us know with a review on Aquasana or your retailer's site.



### NEED HELP?

Give us a call at **866-662-6885** and tell us what's going on.

**Aquasana, Inc.**  
6310 Midway Road  
Haltom City, Texas 76117  
866.662.6885 USA  
877.332.7873 Canada  
[www.aquasana.com](http://www.aquasana.com)