

Controller Unit

301C
User Manual

M-510324
Revision 02
January 2015

Table of Contents

Notices and Trademarks.....	5
Symbol Definitions.....	7
Introduction.....	9
Installation Instructions.....	10
Surface Mount Installation.....	11
Wiring Details.....	12
Power Connections.....	13
Communication Connections.....	13
Settings for Specific Transmitters.....	14
Relay Output.....	14
Jumper Use Instructions.....	15
Initial Startup.....	16
Datalogger (SD card).....	16
Programming Interface.....	17
Keypad Functions.....	17
LED Definitions.....	18
System Operation.....	18
System Programming.....	19
1. Tx Info Menu.....	22
Ident Menu.....	23
Com Menu.....	25
Scale Menus (1 and 2).....	26
Detection Menu.....	27
Display Menu.....	28
Alarm A, B, and C Menus.....	29
Servicing and Operating Menus.....	30
Status Code.....	31
Erase Current Tx.....	31
Change Tx Address.....	32
2. Groups Menu.....	33
Creating Groups.....	34
Deleting Groups.....	35
3. Events Menu.....	36
Action Menu.....	37

continued...

Conditions	40
Status	44
Database	44
4. Acqui Menu	45
Starting and Stopping Tx Logging	46
5. Copy Menu	48
Configuration	49
Parameters.....	49
System Log Menu	50
6. Config Menu	51
7. Network Menu.....	57
Remote Calibration.....	59
8. Tests Menu	61
Test Sequence	63
Normal Mode.....	65
Single Tx Mode	65
Debug Mode.....	65
Detection Menu	27
Simulation Mode.....	66
9. BACnet Menu	67
BACnet/IP Module.....	73
Device Objects	74
Base Objects	75
IAQPoint2	76
E³Point.....	80
XNX and XCD	85
Objects for 301EM.....	87
EC-FX.....	89
420MDBS_IR-F9	92
301ADI	95
301R.....	96
BACnet Protocol Implementation Conformance Statement.....	97
10. Wireless Network.....	103
Specifications.....	104
Limited Warranty.....	105

Notices and Trademarks

Copyright by Honeywell International Inc.

While this information is presented in good faith and believed to be accurate, Honeywell disclaims the implied warranties of merchantability for a particular purpose and makes no express warranties except as may be stated in its written agreement with and for its customers.

In no event is Honeywell liable to anyone for any indirect, special or consequential damages. The information and specifications in this document are subject to change without notice.

This manual covers software version 3.086 and optional BACnet module firmware version 1.3.19.

Honeywell Analytics
3580 rue Isabelle, suite #100
Brossard, QC, Canada
J4Y 2R3





Tel: 800 563 2967

450 619 2450

Fax: 450 619 2525

Symbol Definitions

The following table lists the symbols used in this document to denote certain conditions:

Symbol	Definition
	<p>ATTENTION: Identifies information that requires special consideration</p>
	<p>TIP: Identifies advice or hints for the user, often in terms of performing a task</p>
	<p>REFERENCE _ INTERNAL: Identifies an additional source of information within the bookset.</p>
<p>CAUTION</p>	<p>Indicates a situation which, if not avoided, may result in equipment or work (data) on the system being damaged or lost, or may result in the inability to properly operate the process.</p>
	<p>CAUTION: Indicates a potentially hazardous situation which, if not avoided, may result in minor or moderate injury. It may also be used to alert against unsafe practices.</p> <p>CAUTION: Symbol on the equipment refers the user to the product manual for additional information. The symbol appears next to required information in the manual.</p>
	<p>WARNING: Indicates a potentially hazardous situation which, if not avoided, could result in serious injury or death.</p> <p>WARNING symbol on the equipment refers the user to the product manual for additional information. The symbol appears next to required information in the manual.</p>

Introduction

The 301C controllers act as nerve centers for gas detection networks, providing continuous monitoring for up to 96 connected units (plus 1 301ADI). Once installed and connected, the controllers allow the user to monitor, adjust, or reconfigure an entire network of units.

Intended Use

The controller is intended to monitor an entire gas detection network around the clock. The unit offers logging capabilities, creating log files of all transmitter concentrations and alarms for analysis. The unit is also equipped with grouping or zoning capabilities that allow users to query and monitor specific groups of transmitters or specific transmitter zones.

Receiving and Unpacking

Upon receiving the controller unit:

- Check that the package is undamaged
- Carefully open the package.
- Locate the packing slip or purchase order and verify that all items on the order are present and undamaged

Note: If the package or any of its contents are damaged, please refer to the Warranty section at the back of the manual for instructions.

Installation Instructions

Basic Guidelines

For proper operation of the controller, follow the instructions in this manual carefully.

- Locate all units in areas easily accessible for service.
- Avoid locations where instruments are subject to vibrations
- Avoid locating units near sources of electromagnetic interference
- Avoid locating units in areas subject to significant temperature swings
Verify local requirements and existing codes that may impact choice of location.

Surface Mount Installation

It is recommended that controllers be installed 5 feet (1.5 m) above the floor, at approximate eye level.

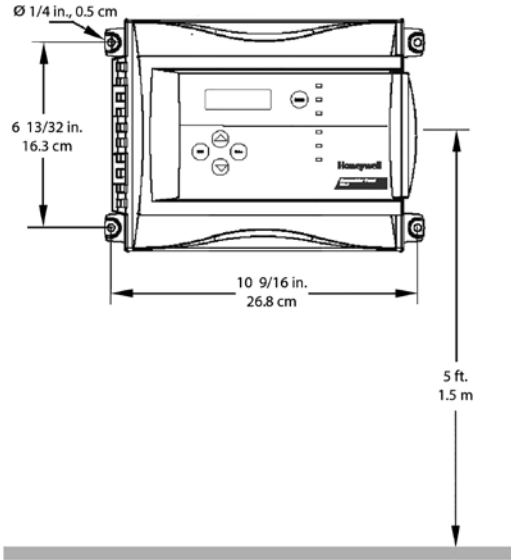

Mark the holes as shown:

- Height markers $6 \frac{13}{32}$ " (16.3 cm) apart
- Width markers $10 \frac{9}{16}$ " (26.8 cm) apart
- Pre-drill $1/4$ " mounting holes as needed
- Securely mount the 301C using the appropriate screws

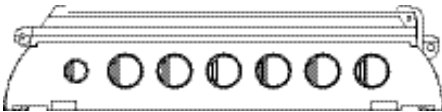

Wiring for the unit must be passed through the knock-outs provided at the bottom of the unit.

Wiring Details

The diagram below provides the details required to connect the 301C controller with power, transmitters, external relay loads, and BACnet. Details concerning power supply, cables, capacities, etc., are provided in the Specifications section at the back of this manual.

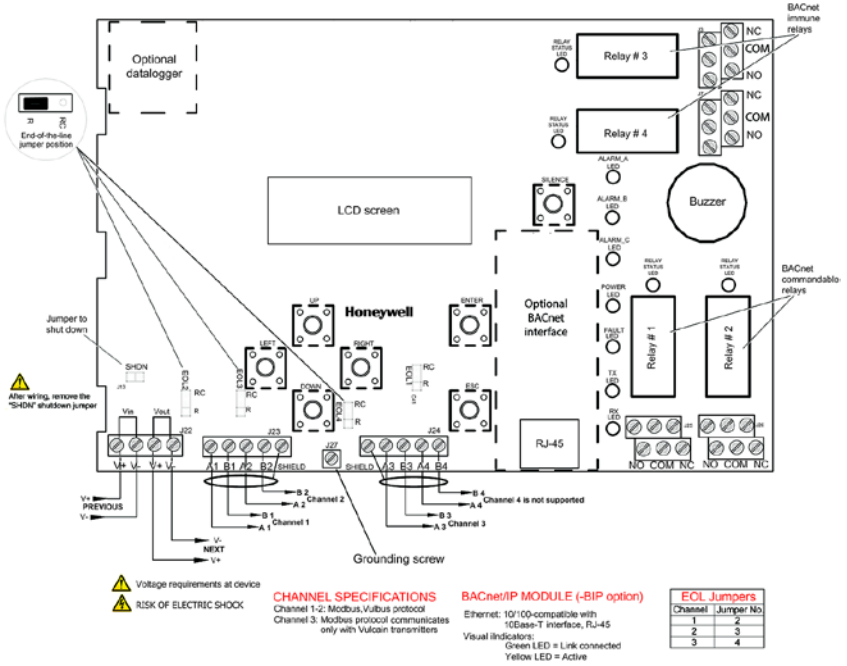

J22 Power Input:	Connect the power supply to the controller (see Wiring Details for cabling diagrams)
J23, J24 Communication inputs:	Connect communication cables to channels 1 through 3.
Relay Outputs 1-4:	Depending on the desired configuration, connect the relay cables to either N.O. or N.C. Relays 1 and 2 are commandable by either internal events or by BACnet; relays 3 and 4 are driven only by internal events.
SHDN jumper	Place the jumper over the Shutdown header pins to reset or restart the system.
EOL Resistors 1-4:	Place the jumper over the header pins to include resistors to attenuate communication echoes.

Power Connections

The 301C requires a power range of 17-27 Vac, 50/60 Hz (8.64 VA), 18-36 Vdc, 350 mA @24 Vdc (8.4 VA). Polarization is not important in either AC or DC mode. The system must be grounded on the transformer and a dedicated circuit breaker must be used.

Communication Connections

Communication cables must be grounded using the shield terminal, using twisted and shielded pair Belden 2-24 AWG #9841 cable (or equivalent).

The network cabling can extend up to a limit of 2000 feet (609 m) per channel.

The length of a T-tap can reach 65 feet (20 m), up to a maximum of 130 feet (40 m) for all T-taps.

The 301C controller communicates with gas sensors over a Modbus RS-485 network. This transmission line requires that 120Ω termination resistors be fitted at both ends of each network segment to absorb the

signal and thus prevent reflections. Fortunately, the controller makes network termination simple as resistors are included on the board. These can be switched in and out of network by moving the “EOL” jumpers as shown in the figure on page 12. More information on RS-485 wiring is published by Maxim Integrated in the [TUTORIAL 763 Guidelines for Proper Wiring of an RS-485 \(TIA/EIA-485-A\) Network](#).

Settings for Specific Transmitters

Honeywell Sensepoint XCD Transmitters must be configured for 9600 baud, no parity, and a unique address. Honeywell XNX Universal Transmitters must be configured for 9600 baud and a unique address. Information on configuring each transmitter is in the associated technical manual.

Some sensors consume multiple addresses on the 301C. Specifically, the 301EM consumes 4 addresses regardless of the number of sensors connected. Additionally, the IAQPoint2 consumes 3 addresses if fitted with the optional temperature / humidity sensor. Please allocate proper address spacing for applications utilizing a mixture of sensors on a single system.

Relay Output

The relay output can withstand up to 5A at 30Vdc or 250Vac resistive load. Relays can be used to activate horns and strobes. Although each relay is programmed with a default setting (below), they can be configured using the controller programming menu.

By default, the relays are normally de-energized and will go energized when events occur. However the relays can be configured for “failsafe” or normally-energized. If so, events will drive them to de-energized.

If relays are set to normally closed, the relay is powered up with the controller and the device linked to the relay is functioning. The relay will shut down when the associated event is activated.

If the relay is set to normally open, the relay will remain off when the controller is powered up and the device connected to the relay will only be activated when the associated event is activated.

Jumper Use Instructions

The jumpers on the controller PCB allow a variety of operations to be performed manually:

EOL 1-4: Enables the user to add End-Of-Line jumpers that improve communication signals. Put the jumper in R position (as shown on wiring diagram) to activate the End-of-Line termination. (R provides a resistance termination and RC provides resistance and condensator termination.)

SHDN: Enables the microcontroller to be reset or temporarily shut down. This function is used mainly when system wiring adjustments are needed (power off for safety).

CAUTION

Power may still be present on the relay terminals even after powering off.

Relays J29-J32 These jumpers allow the relay to be tested by activating it without having any effect on Events.

Initial Startup

Make sure that all wiring has been completed according to specifications in the wiring details before powering up the unit. When all is secure, remove the SHDN jumper to power-up the unit. Within sixty seconds the controller will be fully operational.

Datalogger (SD card)

The DLC (Data Logger Card) option for the controller collects data and stores it on a digital Flash memory card (SDCard). In the event that the card memory becomes full:

- Information logging is stopped
- No SDcard flag is displayed on-screen
- The SDcard LED blinks

See the Acquisition section for more details on starting and stopping the datalogging function. SDHC cards are not supported; use only SD cards.

CAUTION

Always deactivate datalogging function before removing the SDcard. Never remove the card when its LED is on.

Programming Interface

The front panel of the 301C provides a programming keypad (buttons) and LEDs.

301C front panel keypad:



Keypad Functions

Each unit has 7 keypad keys, or buttons:

- Arrows:** Used to move the cursor through the various programming fields (Up, Down, Left and Right), or to adjust the display contrast (press and hold the up or down arrow until desired contrast is reached and release).
- ESC:** Used to exit the programming menu or to cancel a change or input.
- Enter:** Used to access the programming menu and to modify programming fields.
- Silence:** Turns off the controller's buzzer.

LED Definitions

The controller is equipped with 7 LEDs that provide a status for each function related to that indicator:

- Alarm A: A blinking red light indicates that an event has been activated. A constant red light indicates that one or more transmitters has reached Alarm A or Alarm 1.
- Alarm B When the red indicator is on, one or more transmitters has reached Alarm B or Alarm 2.
- Alarm C When the red indicator is on, one or more transmitters has reached Alarm C.
- Power: Green indicates that the unit is powered up and functional
- Fault: When the amber LED is on, it indicates a fault (i.e. a communication, maintenance or device problem)
- Tx: When the amber LED is blinking, it indicates that the controller is *sending* information or requests on the communication channel.
- Rx: When the green LED is blinking, it indicates that the controller is *receiving* information.

Each of these functions is linked to parameters programmed in the control unit, which we will discuss in the following section.

System Operation

The system operates in four different modes that allow it to use, analyze, debug, and simulate the actions that the system can perform. These modes are: Normal, Single Tx, Debug and Simulate. The default system operation mode is Normal. The other modes are available through the Tests menu (option 8 from the Main Menu).

Note: *Systems services may be disrupted by some menu operations. Specifically, viewing the “events” dialogue may inhibit event operation.*



System Programming

The system's Normal programming mode offers several menu options that are accessible from the main menu screen:

1. Tx Info: Allows transmitter parameters to be programmed
2. Groups: Allows sets of multiple transmitters to be aggregated for simpler programming of a common response.
3. Events: Facilitates creation of logical terms which respond to transmitters or events. These Boolean outputs can respond to concentration, alarm, or fault status. These events facilitate voting within a group and can drive relay outputs.
4. Acqui: Allows the datalogging feature to be activated or deactivated
5. Copy: Allows data or parameters to be copied from the (controller) configuration to parameters
6. Config: Allows system parameters and password to be set
7. Network: Allows actions on the network to be performed, communication statistics to be consulted, and remote calibrations to be performed
8. Tests: Allows each device to be tested sequentially (inputs, outputs, communications, events, etc.) and operation of various parameters to be validated
9. BACNet: Allows a device's BACNet parameters to be set
10. Wireless: Not supported.









*Note: Access to the programming functions is password protected.
The default password is 2967.*

The screen display shown below appears initially. This display can be configured to scroll among the information screens for each device connected to the controller.

VA301C	Ver. 3.00	
Ad: 1	Gr:0	Ev:0
 		
2007-01-17	13:18:18	

If one or more of the connected devices is in an alarm mode, the controller will only scroll between the main information screen and the screens for device(s) in alarm mode. In this case, you must scroll manually to view screens for other devices.

The information screen also displays icons representing certain system functions. Here is a list of possible icons and their meaning:

Icon	Description
	BACNet: Indicates that there is a BACNet module present and that it is communicating with the controller.
	BACNet error: Indicates that a BACNet module is present but communication with the controller has failed (error)
	Debug: Indicates whether the controller is in debug mode (Single TX, Debug or Simulation modes). When in simulation mode, SIM appears next to this icon.
	Log: Indicates that either "Tx Logging" or "Event logging" is enabled.
	Log error: Indicates that an error occurred during TX or Event logging. All logging functions are stopped.
	SDC: Indicates that an SDcard is present and functioning. The icon "fills" (from white to black) progressively as memory is used. A white icon indicates empty memory and black indicates full memory.
	SDC error: If this symbol persists for more than 5 seconds, an SD card is present but not functioning properly.
	Wireless network: Indicates that the wireless network coordinator (wireless communication module) is present and communicating with the controller.
	Wireless network error: Indicates that the wireless network coordinator (wireless communication module) is present but is not communicating with the controller.

Since the controller's programming functions are password protected, it is necessary to access the login screen:

- Press Enter to access the programming options. The password screen appears:
- Use the keypad Up or Down arrows to increase or decrease the value, one digit at a time, starting with the first digit
- When all the digits of the password are correct, press Enter to access the programming functions.

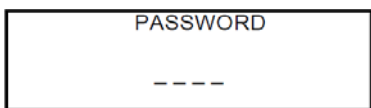

The first MENU options screen appears. Use the keypad arrows to navigate through multiple screens to the desired function and press Enter to access it.

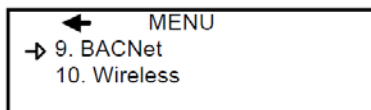
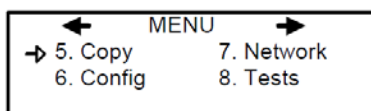
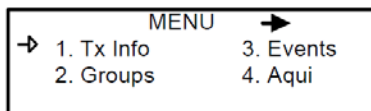

1. Tx Info Menu

Tx Info is the menu option that is dedicated to transmitter information and contains several sub-menu options. The exact list of screens will vary depending on the transmitter type. A summary is presented below with details on the following pages.

- Ident: Allows the network component's identification information to be viewed.
- COM: Allows the communication protocol to be viewed or changed
- Detection or Scale(1) and Scale(2): Allows the detection range and the unit of measurement parameters to be viewed and changed
- Display: Allows the label (or name) of a specific component to be changed
- Alarms: Allow alarm thresholds to be viewed and sometimes changed. There can be significant variations in this screen depending on transmitter type.
- Status Displays: Transmitter and node status (in hexadecimal values)
- Erase or Current Tx: Erases or changes the Tx address

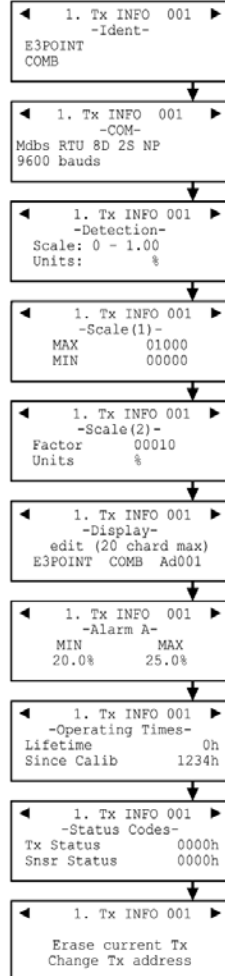

Ident Menu

The Ident, or identification menu allows a component's network ID to be consulted:

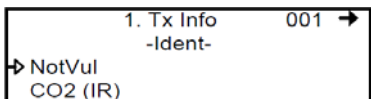

The upper right corner of the screen shows the component's address. If the address of the device whose information must be viewed is known:

- Use the arrows to move the cursor arrow to the on-screen address
- Press Enter (the value can be edited while the number is flashing)
- Use the up or down arrows to increase or decrease the value
- Press Enter again to validate the entry and display the information for the desired device.

The bottom left corner of the display shows the transmitter name (ex.: 301D2 - product name) and the sensor type (ex.: CH4 - methane sensor). These values can also be changed for Group or Vulbus product types. The procedure is identical for both fields:
Programming or changing a product or sensor type

- Use the arrows to move the cursor to the product type field.
- Press Enter to select the field (the value can be modified when flashing)
- Use the arrows to scroll through the list of product types and press Enter when the desired product or sensor appears

Product and Sensor Types

This is a list of all the (preprogrammed) product types available from the Identification option in the Tx Info menu.

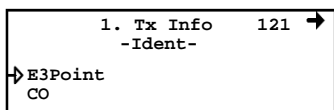

Compatible products:

- E3Point
- 420MDBS
- ECFX
- 301R
- 301EM
- SQN8X
- XCD
- XNX
- IAQPoint2
- Legacy Vulcain products

Note: When Group is selected as a product type, the remaining Tx INFO screens are not accessible (because each product in the group has already been individually programmed). Only the Ident and Erase current Tx screens will be available.

The sensor type list applies to address ranges 1-96 and is not dependent on the type of product selected. Devices in the address range from 97-170 will display a BACNet object identifier, rather than a sensor type.

*An additional Product Type, simply called “Group”, represents a group created in the Groups Menu in the controller. When scrolling through the available product type list, this name will appear as many times as there are groups created in the controller (example: Group 1, Group 2, Group 3, etc.). If a group is selected as the product type, then the sensor type options are limited to MIN, MAX and MEAN.

COM Menu

This screen displays the selected communication protocol for device addresses from 1 to 96. Each transmitter's protocol is defined by the controller (see Network Auto-configuration section)

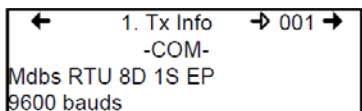

If a transmitter is compatible with several different protocols, it can be modified using to one of the following options:

- Vulbus
- MdbS ASCII 7D 2S NP 9600 bauds
- MdbS RTU 8D 2S NP 9600 bauds
- MdbS RTU 8D 1S NP 9600 bauds
- MdbS RTU 8D 1S OP 9600 bauds

When a transmitter is configured with the Modbus communication protocol, the transmitters automatically sends the programmable parameters to the controller.

Note: Vulbus transmitter parameters must be programmed manually.

Scale Menus (1 and 2)

These menus appear only for certain devices. Scale(1) allows the detection range, minimum and maximum, to be defined for the selected device. Whatever value is specified is the value that will appear at the device display (if applicable). The Minimum value is generally left at 0. Parameters for the XNX and XCD gas detectors can be viewed here but can be changed only at the transmitter.

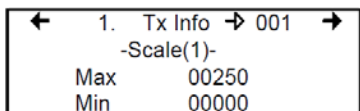

Scale(2) allows the factor by which to divide the scale (between 0 and 65535) and the unit of measurement for the selected scale to be determined.

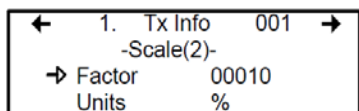

The factor allows precise scale limits for detection to be set. By dividing the maximum scale value in the first Scale screen (250 in this example) by 10, a scale value of 25.0 can then be displayed.

The "Units" allow the device's unit of measurement to be selected:

- °F: Sets degree Fahrenheit as the unit of measurement
- °C Sets degree Centigrade as the unit of measurement
- %RH Sets Relative Humidity as the unit of measurement
- mV Sets millivolts as the unit of measurement
- V Sets volts as the unit of measurement
- mA Sets milliamps as the unit of measurement
- % Sets the percentage of gas as the point unit of measurement
- ppm Sets parts per million of gas as the point unit of measurement

Detection Menu

The detection menu (available only for devices with addresses between 1 and 96) displays the detection range (scale: 0-100.0) and the unit of measurement (unit: %) for the selected component. If a transmitter uses the Modbus protocol, the detection parameters are automatically defined during network configuration and are not editable. Vulbus protocols must be manually defined by the programmer.

The detection scale is between 0 and the maximum value (0.00) and the unit of measurement is either ppm or percent (% for oxygen and % LEL for combustibles).

The detection menu is not available for the VA301R or VA301AP.

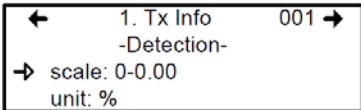

Programming or modifying the scale range or unit:

- Use the arrows to move the cursor to the scale or unit option
- Press Enter and use the arrow to increase or decrease the value
- Press Enter when the desired value is obtained

Display Menu

This option allows a specific label or name to be assigned to the selected component (transmitters, relay modules, annunciators). Up to 20 characters, including spaces, can be used in the label (example: BOILER ROOM). The default Modbus transmitter labels are composed of the component (or transmitter) name, sensor type and address.

Vulbus transmitter labels contain 20 blank characters (spaces).

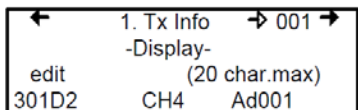

Alarm A, B, and C Menus

The screens for viewing alarm thresholds are combined in this manual. There will be either two or three levels, depending on transmitter type.

If present, separate “MIN” and “MAX” levels permit manual control of the hysteresis of each alarm. Normally, the “MAX” level is set greater than “MIN.” However, alarms can be made to trigger on falling concentration (as with oxygen) by setting the “MAX” threshold smaller than the “MIN” threshold.

With certain transmitters, only one threshold will be displayed.

Additionally, with certain transmitters, the alarm thresholds are read-only at the controller. These thresholds can be set only at the transmitter.

These are typical screens:

```
◀ 1. Tx INFO 001 ▶  
  -Alarm B-  
    Level  
  20.0 ppm
```

Typical screen for viewing alarms A or B on XCD and XNX transmitters

```
◀ 1. Tx INFO 001 ▶  
  -Alarm C-  
  MIN      MAX  
  60.0%    65.0%
```

Typical screen for viewing or changing alarm A, B, or C thresholds on other transmitters.

Servicing and Operating Menus

These functions vary depending on the transmitter type. These displays show the total time the device has been in service and the amount of time remaining until the next required calibration or replacement.

```
◀ 1. Tx INFO 001 ▶  
-Operating Times-  
Lifetime           0h  
Since Calib       1234h
```

```
◀ 1. Tx INFO 001 ▶  
-Servicing-  
1234 Hours on  
15514 before cal.
```

```
◀ 1. Tx INFO 001 ▶  
-Operating Times-  
Sensor life left:  
321 days
```

Status Code

These screens display transmission or node status and sensor status for the selected transmitter. This read-only information can assist service personnel in troubleshooting.

The XNX and XCD gas detectors will report the warning or fault number (iFaultWarnNumber) in hexadecimal on the third line. These transmitters will also report the monitoring state (iMonitoringState) in the fourth line. See the transmitter documentation for interpretation of fault numbers and monitoring states.

```
◀      1. Tx INFO 001      ▶  
-Status Codes-  
Tx Status      0000h  
Monitor State  0001h
```

Typical display for XNX or XCD

```
◀      1. Tx INFO 001      ▶  
-Status Codes-  
Tx Status      0000h  
Snsr Status    0000h
```

Typical display for other transmitters

Erase Current Tx

This function allows the configuration to be erased or the Tx address for the displayed component to be changed.

Note: Selecting erase current Tx only erases the current device entry Tx Info configuration. No other data is erased.

```
◀      1. Tx Info  → 001  →  
  
erase current Tx  
Change Tx Address
```



Change Tx Address

Selecting Change Tx Address allows users to move a device from one TX address to another:

- Use the arrows to scroll to Change Tx Address and press Enter to select
- In the next screen, scroll to the address number and press Enter to select
- Use the up or down arrows to increase or decrease the address value and press Enter to validate the new address.

The Change Tx address option is only available (active) for device address 1 to 96 and if there is a Modbus device connected.

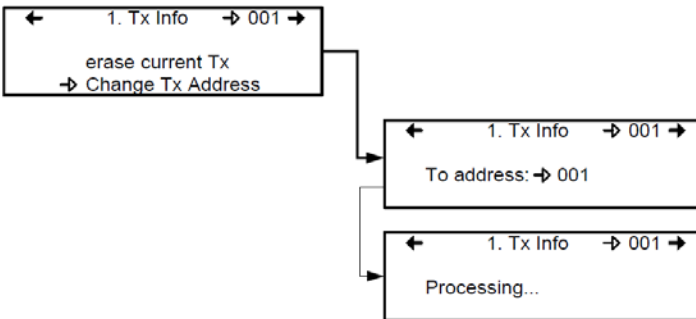
If the address is valid, the screen will display “Processing”. If the address is invalid, the screen will display “Invalid Tx” and return to the Change Tx Address screen (the address for GasPoint devices cannot be changed). A final screen will display either “Error” or “Success” (re-start procedure if Error is displayed).



Note: *If a device address is changed to one already associated with another device, the existing data will be overwritten. Customers should know their network's address assignments and be careful when changing a Tx address. Delete the original Tx address to avoid duplicate entries. This feature is not supported with XNX and XCD transmitters.*

2. Groups Menu

Programming groups of transmitters allows several units to be combined which then enables actions (events) to be taken based on a series of units rather than each unit, individually.

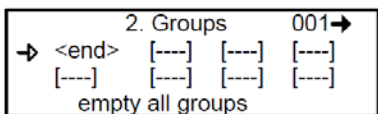
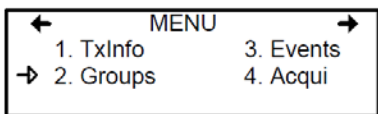

A group is a stack containing the addresses from each of the transmitters included in the group.

Groups are displayed in a single line; if a group contains more than four components, the arrows must be used to scroll left and right of the display window to view all members of a group.

The cursor in the Group screen is represented by the blinking brackets (<end>). Any information between the brackets can be edited.

Creating Groups

- Use the arrows to move the cursor to a group line and press Enter
- The field can be edited when the brackets stop blinking and the word “end” blinks
- Use the up or down arrows to scroll through the list of all units connected to the 301C, until the desired address is displayed .
- Press Enter again to validate the address.
- The address is added to the group and the <end> bracket is shifted one position to the right.

The process can be repeated until all the desired transmitters in the group (up to 126) have been added. The address for each transmitter added in the Tx Info menu is available when creating groups.

Note: Groups created in the Groups menu will appear in the product type list (Tx Info - Ident screen) as “Group xx” (the number assigned to the group when it was created).

Deleting Groups

Use the *empty all groups* command to delete all groups previously programmed in the controller.

Single groups can be deleted with a simple procedure:

- Scroll to the first transmitter in the group list,
- Select the transmitter (its address blinks) and scroll to (erases the entry and <end> marks the end of the stack)
- Press enter and the group is emptied.

This procedure makes it possible to delete one, several or all entries previously included in a group.

Note: *Up to 126 groups, with a maximum of 128 members each, can be created.*

3. Events Menu

The Event menu is programmable. Event programming lets specific actions to be defined:

Action:

What will be done if programmed criteria are reached

```

3. Events → 001→
-Action-
Target: Ctrl
Relay: #01
    
```

Delays:

Defines the length of time to wait before taking an action on an event and time to wait after an event has returned to normal before the action output is returned to normal state.

```

← 3. Events 001→
-Delays-
Before: → 99min
After: 01min
    
```

Conditions:

AND, OR or none (---); equations that allow more detailed control of an event

```

← 3. Events 001→
( 1/3 Gr036 Q ) AND
= 2.01%
    
```

Coverage period:

Determines the period during which the event is applicable

```

← 3. Events → 001→
-Coverage Period-
All day
All week
    
```

Status disabled:

Disables or enables a programmed Event

```

← 3. EVENEMENT → 001
-Status : disabled-
→ Enable event
    
```

Database:

Erases the selected event or all events

```

← 3. Events 001→
-Database-
→ Erase current event
Erase all events
    
```

Action Menu

Actions are comprised of two parameters:

3. Events	→ 001 →
-Action-	
Target:	Ctrl
Relay:	#01

- Target** Indicates which component is responsible for the action to be taken;
Tx (transmitter)
Re (Relay/Annunciator)
Ctrl (Controller)
- Relay** Indicates which of three possible outputs will be activated when the event is true;
#XX (activates the component's #xx relay), Buzzer (activates the component's audible alarm)
ALL (activates the relays and audible alarms)

Example: Tx 007 detects a concentration exceeding the set values. The target (controller) triggers relay 1 connected to that event (a fan perhaps). Multiple events may be associated with a single relay. If so, the relay will be activated if any of the associated events are true.

Delays Menu

This option allows Before and After settings that will delay the activation or deactivation of an action to be programmed.

Before Delays the action for the specified length of time. If the condition persists beyond this delay, the defined action is executed.

After The time to wait after an event has returned to normal before returning action output to normal state. The after delay also offers a Latch option, described below.

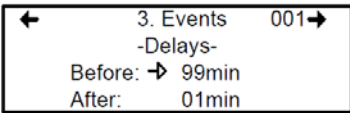

Before and After delays can be configured at either 30 or 45 seconds or from 1 to 99 minutes, in one minute increments. Five dashes (-----) indicates that no delay has been programmed.

- Use the keypad arrows to scroll to the desired option
- Press Enter to select the option
- Use the keypad arrows to scroll through the second or minute settings
- Press Enter at the desired setting. The delay is set.

Latch Mode

- The Latch function is executed on an Event state
- It is possible to select the Latch mode by changing the after delay to “latch”
- The Event stays active until the Silence keypad button is pressed
- The Silence keypad button has two functions: Silence the buzzer and unlatch the event.
- When the Silence keypad button is pressed, events in Latch mode are unlatched and reevaluated. If the Event condition persists, the Event remains active and returns to Latch mode. If the condition does not persist, the event is deactivated.

Note: *If the Event has a Before delay and the Silence button is pressed while the Event conditions are still true, the buzzer will be silenced only for the length of the programmed delay.*

Conditions

Conditions are the parameters that define what makes an Event true. Each condition is defined by four elements and can be combined with other conditions to provide greater flexibility. A condition, as in the example provided below, defines:

IF at least 1/3 of group 36 detects concentrations greater than 2.01% of specified gas AND all of group 03 detects a concentration greater than 2.99% of gas, then the specified action (Actions were set at the first Event screen) for that Event will be triggered.

Since the display screens offer limited space, scroll left and right to view and edit further information.

Condition programming screens

←	3. Events	001→
(1/3 Gr036	Q
)	> 2.01%	AND

←	3. Events	001→
AND (all Gr003	Q
)	> 2.99%	

The portion of the Events condition screen that is within the brackets is divided into four editable list fields:

The top left portion contains the statistic quantifier (available only for Groups) that take only the specified part of the group into the equation. Options available in this field are:

- all: includes all transmitters in the group
- mean: includes the average concentration for the group's transmitters
- max: includes the group's maximum concentration
- min: includes the group's minimum concentration
- 1/4: includes at least a quarter of the group's transmitters that meets set conditions
- 1/3: includes at least a third of the group's transmitters that meets set conditions
- 1/2: includes at least half of the group's transmitters that meets set conditions
- 2/3: includes at least two thirds of the group's transmitters that meets set conditions
- 3/4: includes at least three quarters of the group's transmitters that meets set conditions
- 1 or +: at least one or more than one of the group's transmitters that meets set conditions

The bottom left portion contains the logic, or operator, quantifier that determines how conditions are calculated. Options available in this field are:

Operator Symbol	Meaning
---	No operator
=	Equal to
<=	Equal to or smaller than
<	Smaller than
>=	Equal to or larger than
>	Larger than
!=	Not equal to
max	When the maximum value is reached, an action is triggered. It will not be deactivated until levels fall below minimum value
min	When concentrations fall below minimum value, an action is triggered. It will not be deactivated until concentrations rise above set maximum value

The top right portion contains the source, which defines what device or group of devices the Event will be based on. The list provides the following options:

- GrAll: Includes all transmitters (see note)
- Gr___: Includes only the devices in the specified group (see note)
- Tx000: Includes only the specified transmitter (connected to the controller)
- Clock: Includes only information gathered between the specified times. Selecting clock sets a condition that is applied only between the start and end time frame. It is possible to set one condition screen to specific parameters and the second to clock, which means that the specified condition will trigger an event only if it occurs during the set time period.

Note: *Clicking on the magnifying glass to the right of a Group number on the display opens a view of the Group for consultation or editing. Press Esc to close the group view and return to the Event condition screen.*

The bottom right portion contains the operand, which defines what device or group of devices on which the Event will be based. The list provides the following options:

- OFF: Used for status on binary inputs (ex.: used with 301ADI)
- ON: Used for status on binary inputs (ex.: used with 301ADI)
- Fault: Bases trigger on maintenance alarm, communication failure or device failure
- Alarm A: If the chosen device or group has an Alarm A or Alarm 1, an event will be triggered.
- Alarm B: If the chosen device or group has an Alarm B or Alarm 2, an event will be triggered
- Alarm C: If the chosen device or group has an Alarm C, an event will be triggered.

The Coverage Period screen allows the period that will be covered by the Event to be defined. (The time frames for each of these periods can be defined in the controller Config menu.) This option provides two further selection fields:

Day definition field: allows All day, Daytime, or Nighttime to be selected
Week definition field: Weekend, Working Days, All week

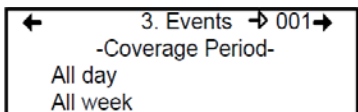

1. Use the keypad up or down arrows to scroll to either All day or All week
2. Press Enter to select. The value can now be changed
3. Use the keypad up or down arrows to scroll through options (see above)
4. Press Enter to select.

Status

This screen displays the current event status and allows it to be either enabled or disabled, depending on the current status.

Enable event: Toggles between Enable and Disable.

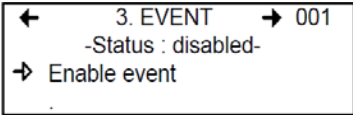

After going through all the steps and programming an event, this screen will display “Enable event”. Press Enter to activate all the parameters and enable the Event.

If an existing Event is being consulted, this screen would display “Disable event”. Press Enter to disable an Event (it will not be deleted but will not function). The programming of this Event is always present, which means that it easily can be reactivated by scrolling to this screen and pressing Enter.

4. Acqui Menu

The Acquisition mode is accessible only when there is an SD card present (controllers with the Data Logging, or DLC function). It is used to enable or disable the logging of system Events or transmitter information. The information is logged (or recorded) on an SD card. Intervals or conditions must be defined before using this option.

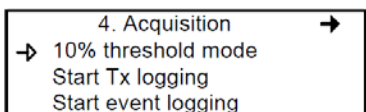

The first line of the Acquisition screen offers either:

Delay mode: Allows for delay intervals of 10 to 59 seconds or 1 to 60 minutes.

Threshold mode: Allows log values to be set according to set variation thresholds (based on last reading) of 3% or more, 5% or more or 10% or more of last detected concentration.

If a 3% threshold is selected, the system will not log a value at 3% but will log a value of 3.1%. Remember that the sampling rate (system refresh rate) may have an impact on logging.

Here is an example of threshold logging. The logs a semi-colon delineated text files.

```
2005-04-27 11:05:20;1_CO2_ppm;574;-normal-:
2005-04-27 11:06:02;1_CO2_ppm;503;-normal-:
2005-04-27 11:06:15;1_CO2_ppm;562;-normal-:
2005-04-27 11:06:28;1_CO2_ppm;645;-normal-:
2005-04-27 11:06:39;1_CO2_ppm;557;-normal-:
2005-04-27 11:30:45;1_CO2_ppm;715;-normal-:
```

Starting and Stopping Tx Logging

In the previous step, “Acquisition”, the frequency at which Tx logs would be recorded can be configured. To start the logging function:

When “Start Tx logging” appears on the display, it indicates that the acquisition, or logging, mode is inactive. When “Stop Tx logging” appears, it indicates that Tx data is being logged. The log message is displayed on the screen according to the chosen mode and LED 1 will light up.

Press the Enter keypad button to stop or start Tx logging.

When Tx data is logged, the system creates files named **tayymmdd.log**, **tbyymmdd.log** and **tcyymmdd.log**, each representing one third of the network. The record includes the transmitter’s date, time and address, the sensor type, the concentration read, as well as the alarm status. Here is a sample of what a Tx log looks like:

```
2004-01-23 17:54:25; 001_CO_ppm:0;-normal-002_NO2_ppm:1.5;-normal-003_CO_ppm:0;-normal-
2004-01-23 17:55:25; 001_CO_ppm:0;-normal-002_NO2_ppm:0.5;-normal-003_CO_ppm:0;-normal-
2004-01-23 17:56:25; 001_CO_ppm:0;-normal-002_NO2_ppm:0.5;-normal-003_CO_ppm:0;-normal-
2004-01-23 17:57:25; 001_CO_ppm:0;-normal-002_NO2_ppm:1.0;-normal-003_CO_ppm:0;-normal-
2004-01-23 17:58:25; 001_CO_ppm:0;-normal-002_NO2_ppm:1.5;-normal-003_CO_ppm:0;-normal-
```

These log files are delimited by semicolons and are thus easily read by popular spreadsheet programs such as Microsoft Excel. The first column of the Tx log displays the date (yyyy-mm-dd) and the time (hh:mm:ss) of the log. In this example, the “Delay mode” was set to one minute intervals.

The third column of the Tx log displays the transmitter address and the fourth displays the gas type, gas concentration and unit of measurement.

The display then lists the next transmitter address with its gas type, concentration and unit of measurement, and so on until all the transmitters have been listed.

Starting and Stopping Event Logging

The Acquisition menu offers an event logging option. Event Logging records controller transactions, events, Tx and alarm flags and relay status.

When “Start Event logging” appears on the display, it indicates that the acquisition, or logging, mode is inactive. When “Stop Event logging” appears, it indicates that Event data is being logged.

Press the Enter keypad button to stop or start Event logging.

When Event data is logged, the system creates a file named **evyyymmdd.log**. The record includes the date, time and the event. Here is a sample of what an Event log looks like:

```
2004-01-23 17:54:25: Event logging enable
2004-01-23 17:55:25: Event logging enabled
2004-01-23 19:05:47: Simulation sequence activated
2004-01-23 19:05:48: Tx 6 communication no more in fault
2004-01-23 19:05:48: Tx 8 communication no more in fault
```

The first column of the Event log displays the date (yyyy-mm-dd) and time (hh:mm:ss) of the log. Column A displays the date and time of the log. In this example, the event’s “Delay mode” was set to one minute intervals.

The system logs the following types of events:

- Event Log
- Event status changed
- Alarm A, B, C, Fault, and X status changed

Note: *New log files are created when the existing files reach 32 000 lines or at the start of a new week (0h00 Sunday)*

5. Copy Menu

The Copy menu allows programmed parameters to be copied and transferred. Data from the SD card can be transferred to a controller or from a controller to the SD card or copy parameters from one device to the next. The Copy option offers three screens: Configuration, Parameters and System Log.

Configuration

If the controller is equipped with an SD card, the configuration function allows data to be transferred either from the 301C to the SD card or the reverse. This makes it possible to transfer the controller's programming to a computer or from a computer to the controller.

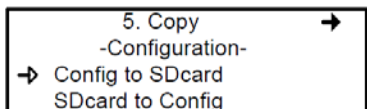

The first option in the configuration screen is 301C to SDcard. Selecting this option copies the controller's configuration and parameters into a "config.ini" file ¹.

Note: The second option is SDcard to 301C allows the configuration and parameters of the "config.ini" file on an SDcard to be copied to the controller. Power must be cycled to fully implement the SD card's configuration by stowing the jumper on the SHDN pin (see the illustration on page 12.) The "config.ini" file contents can be modified at any time and from any computer.

¹When transferring data, the system will automatically search for an existing "config.ini" file before proceeding. If one exists, the system searches for a "config.bak" file. If found, the file is deleted. Then, the pre-existing "config.ini" file is renamed "config.bak", making it possible to save the new "config.ini" file and keep a backup copy of the previous one.

After inserting an SD card into the controller, the controller's system looks for an existing "config.ini" file that contains an "autoload" tag equal to 1 (yes). If the tag is found, the system loads the contents of the file and resets "autoload" to 0 (no). This is a useful feature for editing the file on a computer without having any impact on the controller (such as recorded Events).

Parameters

The “parameters” function allows one transmitter’s configuration to be copied to another or one event’s parameters to be copied to another event. This allows several devices that share identical or similar parameters to be quickly configured.

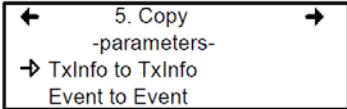

The options within this screen are:

Tx Info to Tx Info copies transmitter parameters from one device to another.

Event to Event copies parameters from Event to Event.

The process is identical for both options:

- Select source, (the data to be copied) using the up/down keypad arrows and press Enter.
- When the transmitter address is flashing, use the up/down keypad buttons to search for the desired device address.
- Press Enter to select the new address
- Select the target address (where the data is to be copied to) in exactly the same way as source
- Select COPY and press Enter. The parameters have been copied.

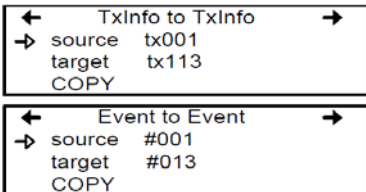

System Log Menu

The controller will record log information to its internal memory. If the controller is equipped with an SD card, the system log function allows users to save system log information to the memory card in text format.

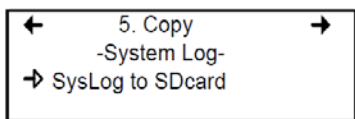

When this option is selected, a log of all the last actions performed on the controller is copied to the SDcard, with the filename **slyymmdd.log**. This file can contain up to a maximum of 64Kb of information in text format. Once the memory card is full, the oldest log entries are erased and replaced by new entries. Here is an example of a system log:

```
--- START of system log dump : 2007-04-18 13:19:05 ---  
2007-04-04 18:42:06;Accessing menu;  
2007-04-04 18:43:47;Event 1 definition modified;  
2007-04-04 18:48:12;Exiting menu;  
2007-04-04 18:54:49;System power-down;  
2007-04-04 18:56:40;System power-up;  
2007-04-04 19:02:44;Accessing menu;  
2007-04-04 19:03:07;Event 6 definition modified;  
2007-04-04 19:03:21;Exiting menu;  
2007-04-05 10:51:28;Accessing menu;  
2007-04-05 10:54:59;Database reset;  
2007-04-05 10:55:18;Tx 25 parameters modified;  
2007-04-05 10:55:29;Group 0 definition modified;  
2007-04-05 10:55:36;Group 0 definition modified;  
2007-04-05 10:55:46;Group 0 definition modified;  
2007-04-05 10:55:55;Group 4 definition modified;  
2007-04-05 10:55:57;Exiting menu;  
2007-04-05 10:56:02;Accessing menu;  
2007-04-05 10:56:19;Tx 24 parameters modified;
```

6. Config Menu

The Config menu contains several main configuration screens and is used to program the controller display mode, adjust the date and time, select the display language, change the controller access password, set the Relay Configuration, and select the AP Broadcast mode.

Each main screen offers further programming options, as shown.

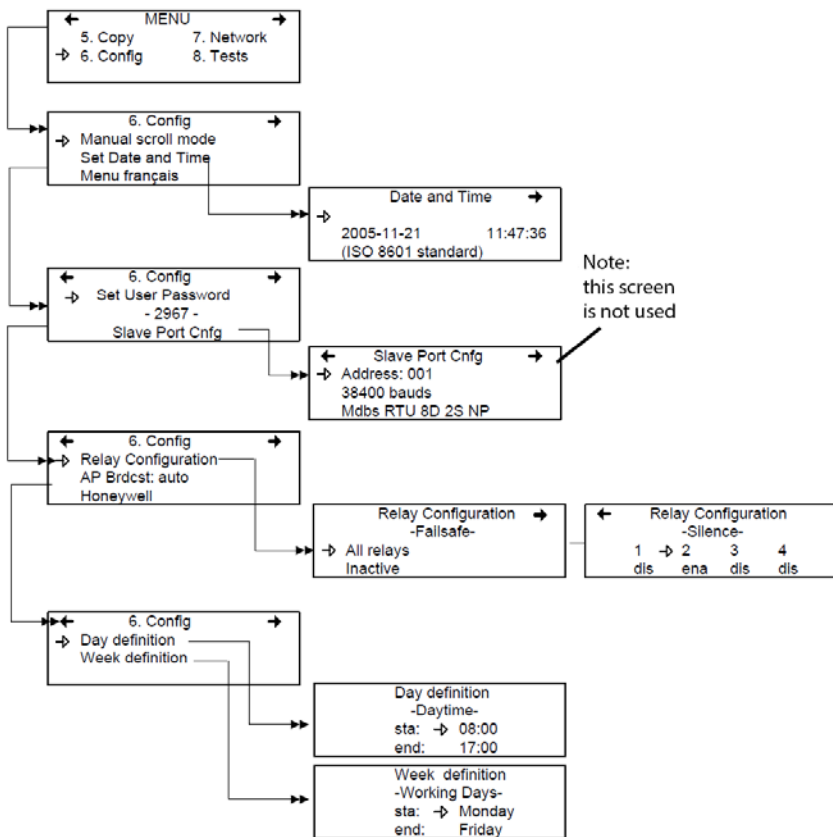

Selecting the first line of the first screen allows selection from three display modes: Manual scroll, 3-second scroll, 5-second scroll. If Manual scroll mode is chosen, the screen will only advance if you press on the arrow keypad buttons. If either 3 or 5 second scroll mode is chosen, the screens will automatically scroll display readings for all devices connected to the controller after 3 or 5 seconds.

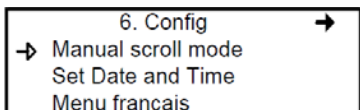

3 or 5 second scroll modes do not prevent the keypad arrows to be used to return to a previous screen or move ahead through the screens manually.

Selecting the second line allows the date and time in a new screen to be adjusted; Date and Time. When a number is flashing, the value can be changed using the up/down keypad arrows. The year, month, day and the hour, minute and second values can be changed.

The controller does not manage Daylight Savings Time, therefore, users must manually adjust any time changes.

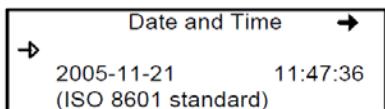

Selecting the third line allows the display language to be changed. If the display is already in English, it will then display the Menu français option (and vice-versa). Simply scroll to the line and press Enter to change the language.

The second main screen in the Config menu allows a new user password to be set.

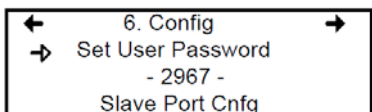

The default password is 2967. Select Set User Password to change the password:

- When the first digit blinks, change the value by using the up/down keypad arrows to increase or decrease the number
- Use the left/right keypad arrows to move from one digit to the next.
- When the desired e has been set, press Enter to validate it and exit the editing mode.

Note: *Contact Honeywell technical support for help with lost passwords at 1-800-563-2967.*

The slave port is not used.

Scroll through the main Config menu screens using the left (previous) or right (next) keypad arrows.

The third main screen in the Config menu allows the relay configuration to be set, the AP broadcast mode and to select from four separate manufacturers for the given controller.

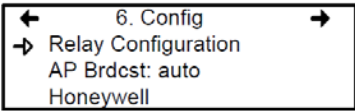

When *Relay Configuration* is selected, two further options to configure the relays are available: The first screen, Failsafe, appears allowing the failsafe to be activated for all relays using the Enter keypad button. This function inverts relay operation to be normally energized. If power is cut, the relay will activate the connected device. (ex. a light.)

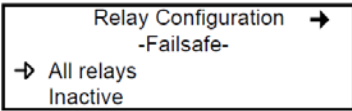

Scrolling to the right displays the “Silence” screen that enables or disables the silence option for each relay, using the Enter keypad button.

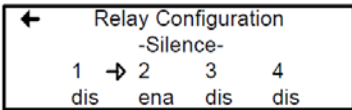

The fourth screen in the Config menu allows a definition of a day and a week to be programmed.

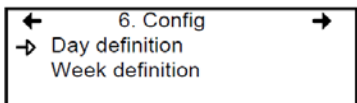

Day and Week definition allows hours (time frames) to be defined for either Daytime and Working Days respectively.

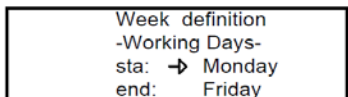
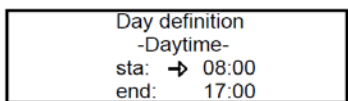

Note: Remember, the controller uses a 24 hour clock (0:00 to 23:59). Any time changes (e.g., for Daylight Savings Time) must be made manually or through BACNet time synchronization (BACNet module required).

7. Network Menu

The Modbus network menu allows network device information to be either scanned or reset.

This menu offers four options, divided into two screens; the first screen contains three options:

- Reset Database: Resets all network device Tx information in the database. This only resets the Tx information for the network device. It does not affect programmed Groups or Events.
- Network Scan: Begins an auto-detect of all network devices that allows the system to configure the Tx database for network devices (i.e. it will scan and add new devices but will not overwrite or erase the old database). This process takes approximately one minute.
- Reset and Scan: Performs both previous functions simultaneously.

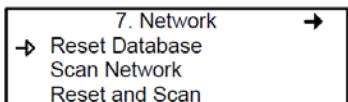

Note: Once one of these options has been set, wait until the controller completes the process. Do not interrupt or stop the process once it has begun.

The second Network screen offers the Statistics and Calibration options.

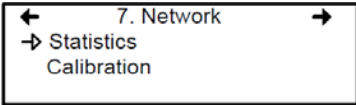

Selecting Statistics from the Network menu displays a screen containing the statistics for the selected device address.

	Statistics	001
Valid	16	100%
Errors	0	0%
Timeouts	0	0%

Valid: Indicates the number of valid responses for the last 16 requests

Errors: Indicates the number of errors in the response for the last 16 requests

Timeouts: Indicates the number of timeouts (no response) for the last 16 requests

Remote Calibration

The network menu also offers a Calibration option for use with devices that support network calibration.

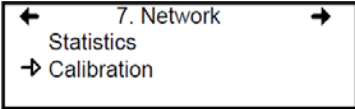

The Calibration screen contains four lines of information:

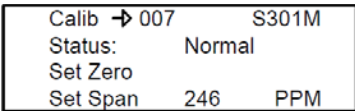

- Line 1: Indicates the mode (Calib, meaning calibration), the (Modbus) address of the device to calibrate (001) and the type of device to calibrate (301D2)
- Line 2: Indicates the status (Normal or In calib...) of the specified device
- Line 3: Displays the function to perform (Set Zero)
- Line 4: Displays the function to perform (Set Span) and the span gas concentration value (246 ppm)

1. On the first line, scroll to the device address and press Enter
2. Scroll through the devices to display the desired device* and press Enter to select.
3. The second line displays the device's status
4. Scroll to select the desired function, Set Zero to set the device's zero, and press Enter to select.
5. Upon pressing Set Zero, the controller requests confirmation.

Calib	007	S301M
Status:	Normal	
→ Set Zero		
Set Span	246	PPM

**The device must be configured in the 301C's database in order to be included in the device addresses displayed on screen.*

6. Press Enter to confirm or Esc to cancel. If confirmed, the controller calibrates the sensor's Zero. This takes only a few moments and the display returns to the default calibration screen.

Note: Never calibrate any unit's Zero with ambient air. Always use Nitrogen (N₂) at the calibration port to calibrate the Zero.

7. To calibrate the device, scroll to Set Span** and change the span gas calibration value using this procedure;

```
Calib 001 : 301D2
Status : Normal
Set Zero
Set Span → 2.60 ppm
```

- a. Using the right arrow, move the cursor to xxx PPM (span value field). Press Enter to select the field (it is editable when flashing).
- b. Use the up or down arrows to increase or decrease the value, press Enter to validate the new value.
- c. Move the cursor back to Set Span and press Enter to start the calibration.

```
Calib 001 : 301D2
Status : In calib...
Set Zero
→ Set Span 2.60 ppm
```

The device Span is being calibrated. The screen will display the device's status as "In calib..." until the calibration is complete.

***When selecting Set Span, make sure that the device has been supplied with the appropriate calibration gas before and during the calibration process.*

8. Tests Menu

The Tests menu allows a variety of tests to be performed on components and on the network communications. It also allows the system to be operated in four different modes which, in turn, provide different functionalities.

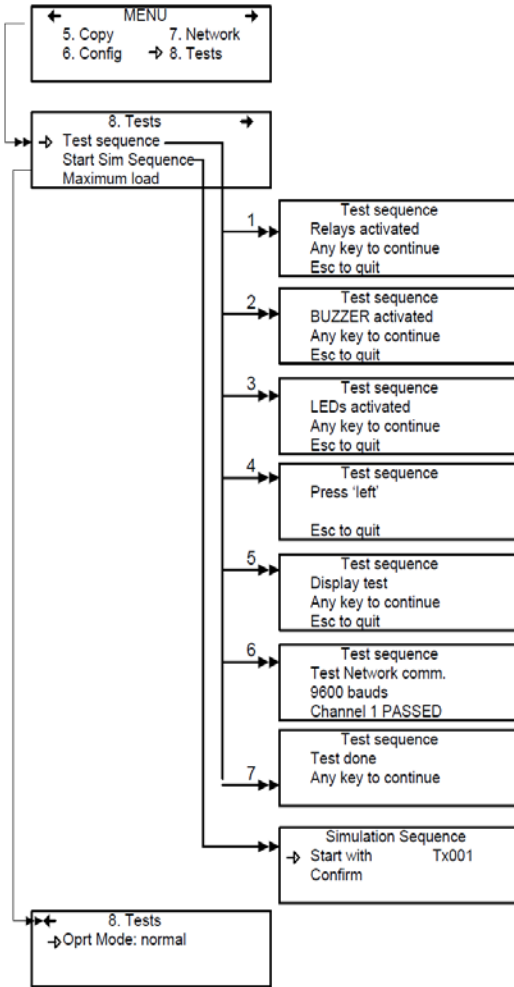

The Tests menu provides four main options, divided between two screens. Each of these options offers different capabilities.

The first screen presents three options:

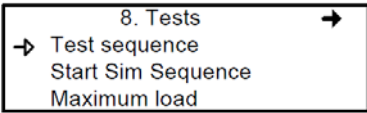

Test sequence: Enables each output to be activated and validates operation of each controller keypad buttons, display pixels, and various communication protocols.

Start Sim

Sequence: This options starts or stops the Simulation mode, which allows a simulation of a gas concentration over an associated scale range on all transmitters. The simulated gas concentration values are local (on the controller) and do not affect logging functions. (Events will be activated for the simulation but detection devices are not affected.)

Maximum load: Activates all controller components

The second screen option is "Oprt Mode", which offers three separate operation settings: Normal, Single Tx or Debug.

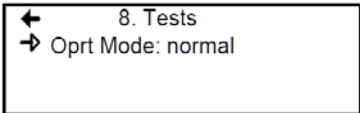

Normal Normal controller operation mode

Single Tx: Activates the polling mode on a single transmitter.

Debug: Activates the service mode to perform a calibration and to test Events without triggering actions.

Test Sequence

When test sequence is selected from the main Tests menu, the controller will display the Test sequence screen.

```
Test sequence
Relays activated
Any key to continue
Esc to quit
```

If Esc is pressed on the keypad, the main Tests menu screen will be displayed. However, to perform system tests, press any key to proceed to the first test screen.

```
Test sequence
BUZZER activated
Any key to continue
Esc to quit
```

- This screen tests each component individually and will advance only to the next component when a key is pressed. This option will display 13 screens. Screens 1, 2, and 3 test Relays, BUZZER and LEDs.

The following six screens prompt the user to press the keypad buttons, in turn: left, right, up, down, Silence, Enter and Esc. The system will not advance until a key is pressed.

```
Test sequence
Press 'left'

Esc to quit
```

The system then moves to the Display test. When the blank screen is displayed, it is testing for display pixels. Press any key to proceed to the next step.

```
Test sequence
Display test
Any key to continue
Esc to quit
```

The final test that the system performs is a network communication test:

```
Test sequence
Test Network comm.
9600 bauds
Channel 1 PASSED
```

Once these tests have begun, do not interrupt or stop them.

When the system has completed the test, it displays the final Tests screen. Press any key to return to the main Tests menu.

```
Test sequence
Test done
Any key to continue
```

Normal Mode

This is the system's normal (default) operation mode. When the system is in normal mode, some values can be changed without interrupting services. When a value has been changed in any of the menu fields, the change will take effect upon returning to the main menu screen.

Single Tx Mode

This mode allows transmitters to be analyzed one at a time. The controller polls only the selected device, which subsequently has its information updated. This mode does not interfere with Event Evaluation functions.

Debug Mode

This mode allows complete system operation to be evaluated and tested without affecting operations (outside of debug mode). **Events are evaluated and displayed as necessary but no action is triggered.**

Simulation Mode

This mode deactivates network communication Information Updates. It can be combined with any of the three previous modes (example: using the Simulation mode when in Debug mode allows the user to test the entire system [groups, events, etc] without triggering any actions or using any additional material such as gases). It allows gas concentrations to be simulated over an associated scale for each transmitter, sequentially:

Alarm levels A, B and C are evaluated according to the simulated gas concentration and events are evaluated and actions are taken.

This type of alarm simulation at the controller does not work with certain transmitters with falling alarms. In these cases, an alarm can be simulated at the transmitter.

While in simulation mode, the controller is unaware of the device's actual network status. This mode can be stopped at any time in the Test menu (see Normal System Operation).

If one of these modes has been activated, the system will automatically return to Normal Mode after 12 hours of inactivity. (No changes will be lost.)

9. BACnet Menu

The BACNet menu on the following page offers several main menu screens to configure the BACNET IP connection, DHCP, server, time zone information and more. Communications parameter changes to the BACnet interface may not be implemented for up to 30 seconds after modification. These parameters include the device ID, the IP address, and the subnet mask.

The 301C controller does not function as a BACnet broadcast management device. If a BBMD is needed, for example when BACnet communications must go through a router, an external BBMD is required.

The 301C foreign device registration feature is not functional.

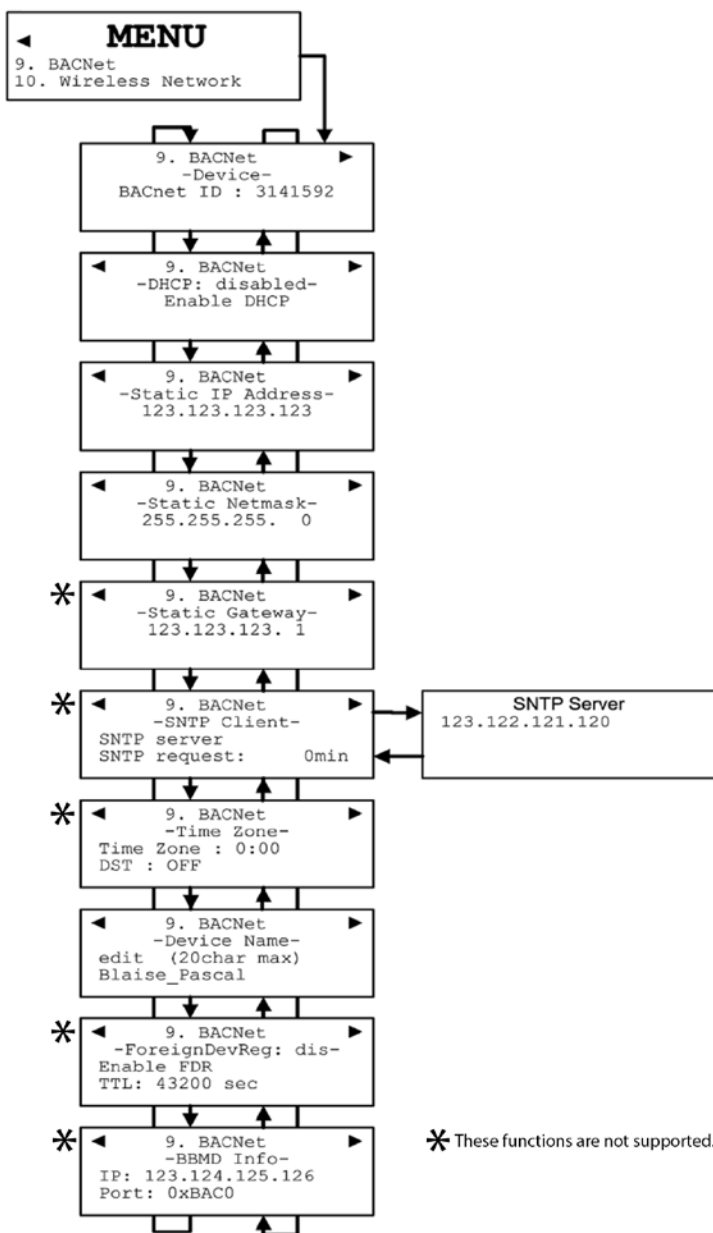

* These functions are not supported.

The first of these screens allows the identification and address to be configured:

```
9. BACNet      →
-Device-
BACnet ID : 1
Static IP address
```

BACnet ID: (Building Automation and Control Networks) is the device ID number assigned to this particular controller on a network.

```
← 9. BACNet →
-Static IP Address-
123.123.123.123
```

Static IP address: This is an address that is used when DHCP is disabled.

Changing BACNet values

- Use the keypad arrows to scroll down to select the desired line and press Enter to select it.
- Selecting BACnet ID activates the field. The ID value (0-4194303) can be increased or decreased using the up or down keypad arrows

If the Static IP address option is selected, the following screen appears. All controllers are shipped with a preset IP address as shown in the example below.

```
-IP address-
→ 192.168. 1.254
-Network mask-
255.255.255. 0
```

The next screen allows the device DHCP (Dynamic Host Configuration Protocol) to be enabled or disabled.

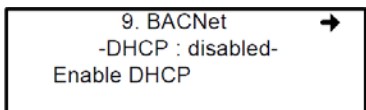

- Press Enter to change the field value.

The Device Name screen allows a specific name to be assigned to the BACNet device.

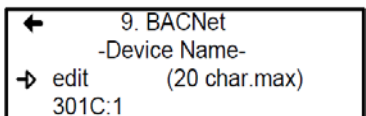

For more information on this subject, please consult the ASHRAE standard number 135-2001, Annex J, section J5.

The BACnet port number is fixed at hexadecimal 0xBAC0 or decimal 47808. It will not function with other port numbers.

Relay Priority

When computing the status of binary outputs such as relays, the 301C prioritizes BACnet commands higher than internal gas events. This is shown graphically below.

BACnet write priority 1 - Manual-Life Safety
BACnet write priority 2 - Automatic-Life Safety
BACnet write priority 3 -
BACnet write priority 4 -
BACnet write priority 5 - Critical Equipment Control
BACnet write priority 6 - Minimum On/Off
BACnet write priority 7 -
BACnet write priority 8 - Manual Operator
BACnet write priority 9 -
BACnet write priority 10 -
BACnet write priority 11 -
BACnet write priority 12 -
BACnet write priority 13 -
BACnet write priority 14 -
BACnet write priority 15 -
BACnet write priority 16 -
Internal 301C events

This can compromise the integrity of the gas detection system in cases where erroneous or malicious BACnet traffic is present. In order to mitigate this risk, version 19 and later BACnet software make some of the relays immune to BACnet commands. This affects 301C relays 3 and 4 and 301R relays 5 to 8 on all 301R modules. Other relays and all buzzers remain BACnet commandable. The E³Point relay remains BACnet commandable.

Network designers are advised to use these BACnet-immune relays for critical safety functions when malicious BACnet traffic is present. In cases where an output must activate in response to either gas events or a BACnet command, Honeywell recommends wiring the contacts of two relays in parallel for a hardwired OR gate.

APDU_segment_timeout

The 301C dynamically instantiates BACnet objects whenever the “Reset and Scan” operation is performed. Several objects are created for each transmitter. The number depends on the type of transmitter. For example each E³Point causes the 301C to create nine objects. Thus the number of BACnet objects can be large – up to 869 in the worst case of 96 E³Points.

One of the results of this is that the controller can be somewhat slow to respond to external BACnet clients. Unfortunately, some BACnet clients have a value of APDU_segment_timeout set too small for use with the 301C controller. This is sometimes manifested as the controller appearing to not respond to discovery requests. Therefore, Honeywell recommends that all BACnet clients which communicate with the 301C controller have timeouts set as listed in the table below:

Number of Transmitters Connected to the 301C Controller	APDU_segment_timeout value (in milliseconds) for BACnet clients which must discover the 301C objects
0 to 10	5000
11 to 34	10,000
35 to 96	20,000

BACnet/IP Module

(BIP option)

Specifications

Ethernet Port : 10 Base-T, RJ-45

Visual Indicators : Green LED LINK
 Yellow LED ACT

Network Configuration: See 301C BACnet menu section.

BACnet/IP protocol

UDP Port: 47808. This value is not modifiable using the 301C.

The module has been developed as per ANSI/ASHRAE Standard 135-2001 : BACnet®— A Data Communication Protocol for Building Automation and Control Networks. The Data Link Layer option is per BACnet/IP (Annex J).

<http://www.ashrae.org/>

The tables on pages 75-97 are also available on the Honeywell Analytics' Commercial Products CD that accompanied the 301C Controller and from the Honeywell Analytics technical library (www.honeywellanalytics.com > Products > Commercial Solutions > 301C > Technical Library).

Device Object

Group	Property	Data Type	Required ¹	Storage Type ²	BACnet Writeable?	Value	
Device	object_identifier	unsigned	R	N	N	Set from LUI	
	object_type	enumerated	R	C	N	device (8)	
	vendor_identifier	enumerated	R	C	N	Honeywell Inc. (17)	
	apdu_timeout	unsigned	R	C	N	0	
	application_software_version	character string	R	C	N	"1.1"	
	firmware_revision	character string	R	C	N	"1.3.18"	
	max_apdu_length_accepted	unsigned	R	C	N	1476	
	model_name	character string	R	C	N	"301C-BIP"	
	number_of_apdu_retries	unsigned	R	C	N	0	
	object_name	character string	R	N	N	default "VA301C:1", settable from LUI.	
	protocol_object_types_supported	bit string	R	C	N	analog_input, analog_output, analog_value, binary_input, binary_value, device	
	protocol_services_supported	bit string	R	C	N	readProperty, readPropertyMultiple, writeProperty, deviceCommunicationControl, reinitializeDevice, i_Am, i_Have, timeSynchronization, who_Has, who_Is,	
	protocol_version	unsigned	R	C	N	1	
	segmentation_supported	enumerated	R	C	N	no_segmentation (3)	
	system_status	enumerated	R	C	N	operational (0)	
	vendor_name	character string	R	C	N	Honeywell	
	protocol_revision	unsigned	R	C	N	2	
	database_revision	unsigned	R	C	N	not meaningful	
		Notes					
		1 --	'R' indicates that this property is required by ASHRAE Standard 135				
		'O' indicates that the property is optional in ASHRAE Standard 135					
	2 --	'C' indicates the property is hard-coded as a constant					
		'N' indicates the property is stored in non-volatile memory					
		'R' indicate the property is computed constantly and stored in RAM.					

Base Objects

Group	Property	Data Type	Required ¹	Storage Type ²	BACnet Writeable?	Value	
Binary Outputs	rel1 to rel4	object_identifier	R	C	N	46344 (or 0xB508) for Relay #1 up to 46347 (or 0xB50B) for Relay #4	
		object_type	enumerated	R	C	N	binary_output (4)
		event_state	enumerated	R	C	N	normal (0)
		object_name	character string	R	N	N	"device_object_name.relX", where device_object_name is programmed on the LUI and defaults to "VA301C:1" and X is relay number (1 to 4). Thus the default object_name for Relay #4 will be "VA301C:1.rel4"
		out_of_service	boolean	R	C	N	FALSE
		polarity	enumerated	R	C	N	always Normal (0)
		present_value	enumerated	R	R	Only Rly1&2. Not Rly 3or4.	True state of the relays. These take the value of the highest-priority BACnet command. If no BACnet command, this takes the value of the associated event.
		priority_array		R	R	N	last value written
		reliability	enumerated	O	C	N	no_fault_detected (0)
		relinquish_default		R	C	N	not meaningful
		active_text	character string	O	C	N	"ON"
		inactive_text	character string	O	C	N	"OFF"
		status_flags					
		in_alarm	boolean	R	C	N	always "false" (0)
	fault	boolean	R	C	N	always "false" (0)	
	overridden	boolean	R	R	N	always "false" (0)	
	out_of_service	boolean	R	R	N	always "false" (0)	
	buzz	object_identifier		R	C	N	46360 (or 0xB518)
		object_type	enumerated	R	C	N	binary_output (4)
		event_state	enumerated	R	C	N	normal (0)
		object_name	character string	R	N	N	"device_object_name.buzz", where device_object_name is programmed on the LUI and defaults to "VA301C:1". Thus the default object_name will be "VA301C:1.buzz"
		out_of_service	boolean	R	C	N	FALSE
		polarity	enumerated	R	C	N	always Normal (0)
		present_value	enumerated	R	R	Y	True state of the buzzer. This takes the value of the highest-priority BACnet command. If no BACnet command, this takes the value of the associated event.
		priority_array		R	R	N	last value written
		reliability	enumerated	O	C	N	no_fault_detected (0)
		relinquish_default		R	C	N	not meaningful
		status_flags					
in_alarm		boolean	R	C	N	always "false" (0)	
fault		boolean	R	C	N	always "false" (0)	
overridden		boolean	R	C	N	always "false" (0)	
out_of_service	boolean	R	C	N	always "false" (0)		
Notes							
1 --	'R' indicates that this property is required by ASHRAE Standard 135 'O' indicates that the property is optional in ASHRAE Standard 135						
2 --	'C' indicates the property is hard-coded as a constant 'N' indicates the property is stored in non-volatile memory 'R' indicate the property is computed constantly and stored in RAM.						

IAQPoint2

Group	Property	Data Type	Required ¹	Storage Type ²	BACnet Writeable?	Value	
Analog Input	IAQPoint CO2	object_identifier	R	C	N	Modbus address * 256 + 1. For example an IAQPoint2 at Modbus address 005 will appear as 1281 or 0x0501.	
		object_type	enumerated	R	C	N	analog_input (0)
		event_state	enumerated	R	R	N	if gas sensor fault Fault (1), else normal (0)
		object_name	character string	R	N	N	"IAQPoint CO2 AdXXX.CO2" where XXX is the Modbus address.
		out_of_service	boolean	R	R	N	FALSE
		present_value	real	R	R	N	Gas reading if CO2 fitted, 0 to 5000 if VOC fitted, 0 to 100
		reliability	enumerated	O	R	N	As appropriate reports no_fault_detected (0) or no_sensor (1) or unreliable other (7) Fault is detected within 60 seconds
		status_flags					
		in_alarm	boolean	R	R	N	if faulty "true" (1) else "false" (0)
		fault	boolean	R	R	N	if faulty "true" (1) else "false" (0)
		overridden	boolean	R	R	N	"false" (0)
		out_of_service	boolean	R	R	N	"false" (0)
		units	enumerated	R	N	N	if CO2 fitted, ppm (96) if VOC fitted, % (98)
		Analog Input	IAQPoint ToC	object_identifier	R	C	N
object_type	enumerated			R	C	N	analog_input (0)
event_state	enumerated			R	R	N	if temp sensor fault, fault (1), else normal (0)
object_name	character string			R	N	N	"IAQPoint ToC AdXXX.ToC" where XXX is the Modbus address plus one.
out_of_service	boolean			R	R	N	FALSE
present_value	real			R	R	N	Temperature reading in Celcius, regardless of IAQPoint2 configuration.
reliability	enumerated			O	R	N	As appropriate reports no_fault_detected (0) or no_sensor (1) or unreliable other (7) Fault is detected within 60 seconds
status_flags							
in_alarm	boolean			R	R	N	if not purchased or faulty "true" (1) else "false" (0)
fault	boolean			R	R	N	if not purchased or faulty "true" (1) else "false" (0)
overridden	boolean			R	C	N	False (0)
out_of_service	boolean			R	R	N	"false" (0)
units	enumerated			R	N	N	Celcius (62)
Notes							
1 --	'R' indicates that this property is required by ASHRAE Standard 135						
	'O' indicates that the property is optional in ASHRAE Standard 135						
2 --	'C' indicates the property is hard-coded as a constant						
	'N' indicates the property is stored in non-volatile memory						
	'R' indicate the property is computed constantly and stored in RAM.						

IAQPoint2 continued

Group	Property	Data Type	Required ¹	Storage Type ²	BACnet Writeable?	Value	
Analog Inputs IAQPoint RH	object_identifier		R	C	N	Sensor number * 256 + 1. Sensor number for RH is Modbus address + 2. For example an IAQPoint2 at Modbus address 005 will appear as 1793 or 0x0701.	
	object_type	enumerated	R	C	N	analog_input (0)	
	event_state	enumerated	R	R	N	if temp sensor fault, fault (1), else normal (0)	
	object_name	character string	R	N	N	"IAQPoint RH AdXXX.RH" where XXX is the Modbus address plus two.	
	out_of_service	boolean	R	R	N	FALSE	
	present_value	real	R	R	N	Relative Humidity in percent	
	reliability	enumerated	O	R	N	As appropriate reports no_fault_detected (0) or no_sensor (1) or unreliable other (7) Fault is detected within 60 seconds	
	status_flags						
	in_alarm	boolean	R	R	N	if not purchased or faulty "true" (1) else "false" (0)	
	fault	boolean	R	R	N	if not purchased or faulty "true" (1) else "false" (0)	
	overridden	boolean	R	C	N	False (0)	
	out_of_service	boolean	R	R	N	False (0)	
	units	enumerated	R	N	N	percent relative humidity (29)	
	Notes						
1 --	'R' indicates that this property is required by ASHRAE Standard 135						
	'O' indicates that the property is optional in ASHRAE Standard 135						
2 --	'C' indicates the property is hard-coded as a constant						
	'N' indicates the property is stored in non-volatile memory						
	'R' indicate the property is computed constantly and stored in RAM.						
continued...							

IAQPoint2 continued

Group	Property	Data Type	Required ¹	Storage Type ²	BACnet Writeable?	Value	
Analog Values	Amin	object_identifier	R	N	N	Modbus address * 256 + 2. For example an IAQPoint2 at Modbus address 005 will appear as 1282 or 0x0502.	
		object_type	enumerated	R	C	N	analog_value (2)
		event_state	enumerated	R	C	N	normal (0)
		object_name	character string	R	N	N	IAQPoint CO2 AdXXX.Amin" where XXX is the Modbus address.
		out_of_service	boolean	R	C	N	FALSE
		present_value	real	R	N	Y	Gas threshold less hysteresis. This is copied from the sensor via the 301C. BACnet permits writing. But this has no effect and the value reverts in a few seconds.
		reliability	enumerated	O	C	N	no_fault_detected (0)
		status_flags					
		in_alarm	boolean	R	C	N	always false (0)
		fault	boolean	R	C	N	always false (0)
	overridden	boolean	R	C	N	always false (0)	
	out_of_service	boolean	R	C	N	always false (0)	
	units	enumerated	R	C	N	if CO2 fitted, ppm (96) if VOC fitted, % (98)	
	Amax	object_identifier		R	N	N	Modbus address * 256 + 3. For example an IAQPoint2 at Modbus address 005 will appear as 1283 or 0x0503.
		object_type	enumerated	R	C	N	analog_value (2)
		event_state	enumerated	R	C	N	normal (0)
		object_name	character string	R	N	N	IAQPoint CO2 AdXXX.Amax" where XXX is the Modbus address.
		out_of_service	boolean	R	C	N	FALSE
		present_value	real	R	N	Y	Gas threshold. This is copied from the sensor via the 301C. BACnet permits writing. But this has no effect and the value reverts in a few seconds.
		reliability	enumerated	O	C	N	no_fault_detected (0)
status_flags							
in_alarm		boolean	R	C	N	always false (0)	
fault		boolean	R	C	N	always false (0)	
overridden	boolean	R	C	N	always false (0)		
out_of_service	boolean	R	C	N	always false (0)		
units	enumerated	R	C	N	if CO2 fitted, ppm (96) if VOC fitted, % (98)		
Notes							
1 --	'R' indicates that this property is required by ASHRAE Standard 135						
	'O' indicates that the property is optional in ASHRAE Standard 135						
2 --	'C' indicates the property is hard-coded as a constant						
	'N' indicates the property is stored in non-volatile memory						
	'R' indicate the property is computed constantly and stored in RAM.						
	continued...						

IAQPoint2 continued

Group	Property	Data Type	Required ¹	Storage Type ²	BACnet Writeable?	Value	
Analog Values	Bmin	object_identifier	R	N	N	Modbus address * 256 + 4. For example an IAQPoint2 at Modbus address 005 will appear as 1284 or 0x0504.	
		object_type	enumerated	R	C	N	analog_value (2)
		event_state	enumerated	R	C	N	normal (0)
		object_name	character string	R	N	N	IAQPoint CO2 AdXXX.Bmin" where XXX is the Modbus address.
		out_of_service	boolean	R	C	N	FALSE
		present_value	real	R	N	Y	Gas threshold. This is copied from the sensor via the 301C. BACnet permits writing. But this has no effect and the value reverts in a few seconds.
		reliability	enumerated	O	C	N	no_fault_detected (0)
		status_flags					
		in_alarm	boolean	R	C	N	always false (0)
		fault	boolean	R	C	N	always false (0)
	overridden	boolean	R	C	N	always false (0)	
	out_of_service	boolean	R	C	N	always false (0)	
	units	enumerated	R	C	N	if CO2 fitted, ppm (96) if VOC fitted, % (98)	
	Bmax	object_identifier		R	N	N	Modbus address * 256 + 5. For example an IAQPoint2 at Modbus address 005 will appear as 1285 or 0x0505.
		object_type	enumerated	R	C	N	analog_value (2)
		event_state	enumerated	R	C	N	normal (0)
		object_name	character string	R	N	N	IAQPoint CO2 AdXXX.Bmax" where XXX is the Modbus address.
		out_of_service	boolean	R	C	N	FALSE
		present_value	real	R	N	Y	Gas threshold. This is copied from the sensor via the 301C. BACnet permits writing. But this has no effect and the value reverts in a few seconds.
		reliability	enumerated	O	C	N	no_fault_detected (0)
status_flags							
in_alarm		boolean	R	C	N	always false (0)	
fault		boolean	R	C	N	always false (0)	
overridden	boolean	R	C	N	always false (0)		
out_of_service	boolean	R	C	N	always false (0)		
units	enumerated	R	C	N	if CO2 fitted, ppm (96) if VOC fitted, % (98)		
Notes							
	1 --	'R' indicates that this property is required by ASHRAE Standard 135					
		'O' indicates that the property is optional in ASHRAE Standard 135					
	2 --	'C' indicates the property is hard-coded as a constant					
		'N' indicates the property is stored in non-volatile memory					
		'R' indicate the property is computed constantly and stored in RAM.					

E3Point

Group	Property	Data Type	Required ¹	Storage Type ²	BACnet Writeable?	Value
analog_input gas	object_identifier		R	C	N	Modbus address * 256 + 1. For example an E3Point at Modbus address 009 will appear as 2305 or 0x0901.
	object_type	enumerated	R	C	N	analog_input (0)
	event_state	enumerated	R	R	N	if gas sensor fault Fault (1), else normal (0)
	object_name	character string	R	N	N	"E3POINT GGGG AdXXX.GGGG" where GGGG is the gas name and XXX is the Modbus address. Values for gas name include "CO" and "COMB".
	out_of_service	boolean	R	R	N	FALSE
	present_value	real	R	R	N	Gas reading
	reliability	enumerated	O	R	N	As appropriate reports no_fault_detected (0) or unreliable other (7) Fault is detected within 60 seconds
	status_flags					
	in_alarm	boolean	R	R	N	if alarm or fault "true" (1) else "false" (0)
	fault	boolean	R	R	N	if faulty "true" (1) else "false" (0)
	overridden	boolean	R	R	N	"false" (0)
	out_of_service	boolean	R	R	N	"false" (0)
	units	enumerated	R	N	N	ppm (96) or % (98)
Notes						
1 --	'R' indicates that this property is required by ASHRAE Standard 135 'O' indicates that the property is optional in ASHRAE Standard 135					
2 --	'C' indicates the property is hard-coded as a constant 'N' indicates the property is stored in non-volatile memory 'R' indicate the property is computed constantly and stored in RAM.					
						continued...

E3Point continued

Group	Property	Data Type	Required ¹	Storage Type ²	BACnet Writeable?	Value	
Analog Values	Amin	object_identifier	R	N	N	Modbus address * 256 + 2. For example an E3Point at Modbus address 000 will appear as 2306 or 0x0902.	
		object_type	enumerated	R	C	N	analog_value (2)
		event_state	enumerated	R	C	N	normal (0)
		object_name	character string	R	N	N	"E3POINT GGGG AdXXX.Amin" where GGGG is the gas name and XXX is the Modbus address. Values for gas name include "CO" and "COMB".
		out_of_service	boolean	R	C	N	FALSE
		present_value	real	R	N	Y	Gas threshold less hysteresis. Synchronization is maintained with the 301C and the E3Point. Whichever value is written last is distributed to the other two locations.
		reliability	enumerated	O	C	N	no_fault_detected (0)
		status_flags					
		in_alarm	boolean	R	C	N	always false (0)
		fault	boolean	R	C	N	always false (0)
	overridden	boolean	R	C	N	always false (0)	
	out_of_service	boolean	R	C	N	always false (0)	
	units	enumerated	R	C	N	ppm (96) or % (98)	
	Amax	object_identifier		R	N	N	Modbus address * 256 + 3. For example an E3Point at Modbus address 009 will appear as 2307 or 0x0903.
		object_type	enumerated	R	C	N	analog_value (2)
		event_state	enumerated	R	C	N	normal (0)
		object_name	character string	R	N	N	"E3POINT GGGG AdXXX.Amax" where GGGG is the gas name and XXX is the Modbus address. Values for gas name include "CO" and "COMB".
		out_of_service	boolean	R	C	N	FALSE
		present_value	real	R	N	Y	Gas threshold. Synchronization is maintained with the 301C and the E3Point. Whichever value is written last is distributed to the other two locations.
		reliability	enumerated	O	C	N	no_fault_detected (0)
status_flags							
in_alarm		boolean	R	C	N	always false (0)	
fault		boolean	R	C	N	always false (0)	
overridden	boolean	R	C	N	always false (0)		
out_of_service	boolean	R	C	N	always false (0)		
units	enumerated	R	C	N	ppm (96) or % (98)		

Notes

- 1 -- 'R' indicates that this property is required by ASHRAE Standard 135
- 'O' indicates that the property is optional in ASHRAE Standard 135
- 2 -- 'C' indicates the property is hard-coded as a constant
- 'N' indicates the property is stored in non-volatile memory
- 'R' indicate the property is computed constantly and stored in RAM.

continued...

E3Point continued

Group	Property	Data Type	Required ¹	Storage Type ²	BACnet Writeable?	Value	
Analog Values	Bmin	object_identifier	R	N	N	Modbus address * 256 + 4. For example an E3Point at Modbus address 009 will appear as 2308 or 0x0904.	
		object_type	enumerated	R	C	N	analog_value (2)
		event_state	enumerated	R	C	N	normal (0)
		object_name	character string	R	N	N	"E3POINT GGGG AdXXX.Bmin" where GGGG is the gas name and XXX is the Modbus address. Values for gas name include "CO" and "COMB".
		out_of_service	boolean	R	C	N	FALSE
		present_value	real	R	N	Y	Gas threshold less hysteresis. Synchronization is maintained with the 301C and the E3Point. Whichever value is written last is distributed to the other two locations.
		reliability	enumerated	O	C	N	no_fault_detected (0)
		status_flags					
		in_alarm	boolean	R	C	N	always false (0)
		fault	boolean	R	C	N	always false (0)
	overridden	boolean	R	C	N	always false (0)	
	out_of_service	boolean	R	C	N	always false (0)	
	units	enumerated	R	C	N	ppm (96) or % (98)	
	Bmax	object_identifier		R	N	N	Modbus address * 256 + 5. For example an E3Point at Modbus address 009 will appear as 2309 or 0x0905.
		object_type	enumerated	R	C	N	analog_value (2)
		event_state	enumerated	R	C	N	normal (0)
		object_name	character string	R	N	N	"E3POINT GGGG AdXXX.Bmax" where GGGG is the gas name and XXX is the Modbus address. Values for gas name include "CO" and "COMB".
		out_of_service	boolean	R	C	N	FALSE
		present_value	real	R	N	Y	Gas threshold. Synchronization is maintained with the 301C and the E3Point. Whichever value is written last is distributed to the other two locations.
		reliability	enumerated	O	C	N	no_fault_detected (0)
status_flags							
in_alarm		boolean	R	C	N	always false (0)	
fault		boolean	R	C	N	always false (0)	
overridden	boolean	R	C	N	always false (0)		
out_of_service	boolean	R	C	N	always false (0)		
units	enumerated	R	C	N	ppm (96) or % (98)		
Notes							
1 --	'R' indicates that this property is required by ASHRAE Standard 135						
	'O' indicates that the property is optional in ASHRAE Standard 135						
2 --	'C' indicates the property is hard-coded as a constant						
	'N' indicates the property is stored in non-volatile memory						
	'R' indicate the property is computed constantly and stored in RAM.						

continued...

E³Point continued

Group	Property	Data Type	Required ¹	Storage Type ²	BACnet Writeable?	Value	
Analog Values	Cmin	object_identifier	R	N	N	Modbus address * 256 + 6. For example an E3Point at Modbus address 009 will appear as 2310 or 0x0906.	
		object_type	enumerated	R	C	N	analog_value (2)
		event_state	enumerated	R	C	N	normal (0)
		object_name	character string	R	N	N	"E3POINT GGGG AdXXX.Cmin" where GGGG is the gas name and XXX is the Modbus address. Values for gas name include "CO" and "COMB".
		out_of_service	boolean	R	C	N	FALSE
		present_value	real	R	N	Y	Gas threshold less hysteresis. Synchronization is maintained with the 301C and the E3Point. Whichever value is written last is distributed to the other two locations.
		reliability	enumerated	O	C	N	no_fault_detected (0)
		status_flags					
		in_alarm	boolean	R	C	N	always false (0)
		fault	boolean	R	C	N	always false (0)
	overridden	boolean	R	C	N	always false (0)	
	out_of_service	boolean	R	C	N	always false (0)	
	units	enumerated	R	C	N	ppm (96) or % (98)	
	Cmax	object_identifier		R	N	N	Modbus address * 256 + 7. For example an E3Point at Modbus address 009 will appear as 2311 or 0x0907.
		object_type	enumerated	R	C	N	analog_value (2)
		event_state	enumerated	R	C	N	normal (0)
		object_name	character string	R	N	N	"E3POINT GGGG AdXXX.Cmax" where GGGG is the gas name and XXX is the Modbus address. Values for gas name include "CO" and "COMB".
		out_of_service	boolean	R	C	N	FALSE
		present_value	real	R	N	Y	Gas threshold. Synchronization is maintained with the 301C and the E3Point. Whichever value is written last is distributed to the other two locations.
		reliability	enumerated	O	C	N	no_fault_detected (0)
status_flags							
in_alarm		boolean	R	C	N	always false (0)	
fault		boolean	R	C	N	always false (0)	
overridden	boolean	R	C	N	always false (0)		
out_of_service	boolean	R	C	N	always false (0)		
units	enumerated	R	C	N	ppm (96) or % (98)		
	Notes						
	1 --					'R' indicates that this property is required by ASHRAE Standard 135	
						'O' indicates that the property is optional in ASHRAE Standard 135	
	2 --					'C' indicates the property is hard-coded as a constant	
						'N' indicates the property is stored in non-volatile memory	
						'R' indicate the property is computed constantly and stored in RAM.	
						continued...	

E3Point continued

Group	Property	Data Type	Required ¹	Storage Type ²	BACnet Writeable?	Value	
Binary Outputs	rel1 (really buzzer)	object_identifier	R	C	N	Modbus address * 256 + 8. For example an E3Point at Modbus address 009 will appear as 2312 or 0x0908.	
		object_type	enumerated	R	C	N	binary_output (4)
		event_state	enumerated	R	C	N	normal (0)
		object_name	character string	R	N	N	"E3POINT GGGG AdXXX.rel1" where GGGG is the gas name and XXX is the Modbus address. Values for gas name include "CO" and "COMB".
		out_of_service	boolean	R	C	N	FALSE
		polarity	enumerated	R	C	N	always Normal (0)
		present_value	enumerated	R	R	Y	Reading this reports the true state of the buzzer. Mixing BACnet and event control of this output is not supported.
		priority_array		R	R	N	last value written
		reliability	enumerated	O	C	N	no_fault_detected (0)
		relinquish_default		R	C	N	not meaningful.
	active_text	character string	O	C	N	"ON"	
	inactive_text	character string	O	C	N	"OFF"	
	status_flags						
	in_alarm	boolean	R	C	N	always "false" (0)	
	fault	boolean	R	C	N	always "false" (0)	
	overridden	boolean	R	R	N	always "false" (0)	
	out_of_service	boolean	R	R	N	always "false" (0)	
	rel2 (physical relay)	object_identifier		R	C	N	Modbus address * 256 + 9. For example an E3Point at Modbus address 009 will appear as 2313 or 0x0909.
		object_type	enumerated	R	C	N	binary_output (4)
		event_state	enumerated	R	C	N	normal (0)
object_name		character string	R	N	N	"E3POINT GGGG AdXXX.rel2" where GGGG is the gas name and XXX is the Modbus address. Values for gas name include "CO" and "COMB".	
out_of_service		boolean	R	C	N	FALSE	
polarity		enumerated	R	C	N	always Normal (0)	
present_value		enumerated	R	R	Y	Reading this reports the true state of the relay. Mixing BACnet and event control of this output is not supported.	
priority_array			R	R	N	last value written	
reliability		enumerated	O	C	N	no_fault_detected (0)	
relinquish_default			R	C	N	not meaningful.	
status_flags							
in_alarm	boolean	R	C	N	always "false" (0)		
fault	boolean	R	C	N	always "false" (0)		
overridden	boolean	R	C	N	always "false" (0)		
out_of_service	boolean	R	C	N	always "false" (0)		
Notes							
1 --	'R' indicates that this property is required by ASHRAE Standard 135						
	'O' indicates that the property is optional in ASHRAE Standard 135						
2 --	'C' indicates the property is hard-coded as a constant						
	'N' indicates the property is stored in non-volatile memory						
	'R' indicate the property is computed constantly and stored in RAM.						

XXN and XCD

Group	Property	Data Type	Required ¹	Storage Type ²	BACnet Writeable?	Value
analog_input gas	object_identifier		R	C	N	Modbus address * 256 + 1. For example an XXN at Modbus address 010 will appear as 2561 or 0x0A01.
	object_type	enumerated	R	C	N	analog_input (0)
	event_state	enumerated	R	R	N	if gas sensor fault Fault (1), else normal (0)
	object_name	character string	R	N	N	"SSS GGGG AdAAA.GGGGG" where SSS is the sensor type, GGGG is the gas name and AAA is the Modbus address. Gas names are truncated to 4 and 5 characters. Values for sensor type are "XXN" or "XCD" For example, an XXN at address 10 with a Methane sensor will populate this object name with "XXN Meth Ad010.Metha"
	out_of_service	boolean	R	R	N	FALSE
	present_value	real	R	R	N	Gas reading
	reliability	enumerated	O	R	N	As appropriate reports no_fault_detected (0) or unreliable other (7) Fault is detected within 60 seconds
	status_flags					
	in_alarm	boolean	R	R	N	if faulty "true" (1) else "false" (0)
	fault	boolean	R	R	N	if faulty "true" (1) else "false" (0)
	overridden	boolean	R	R	N	"false" (0)
	out_of_service	boolean	R	R	N	"false" (0)
	units	enumerated	R	N	N	96 (ppm) or 98 (percent) or 95 (no_units)
Notes						
1 --	'R' indicates that this property is required by ASHRAE Standard 135 'O' indicates that the property is optional in ASHRAE Standard 135					
2 --	'C' indicates the property is hard-coded as a constant 'N' indicates the property is stored in non-volatile memory 'R' indicate the property is computed constantly and stored in RAM.					
						continued...

XNX and XCD continued

Group	Property	Data Type	Required ¹	Storage Type ²	BACnet Writeable?	Value	
Analog Values	AlarmA	object_identifier	R	N	N	Modbus address * 256 + 2. For example an XNX at Modbus address 010 will appear as 2562 or 0x0A02.	
		object_type	enumerated	R	C	N	analog_value (2)
		event_state	enumerated	R	C	N	normal (0)
		object_name	character string	R	N	N	"SSS GGGG AdAAA.AlarmA" where SSS is the sensor type, GGGG is the gas name and AAA is the Modbus address. Values for gas name include "CO" and "COMB". Gas names are truncated to 4 characters. Values for sensor type are "XNX" or "XCD" For example, an XNX at address 10 with a Methane sensor will populate this object name with "XNX Meth Ad010.AlarmA"
		out_of_service	boolean	R	C	N	FALSE
		present_value	real	R	N	N	Alarm1 threshold copied from sensor through the 301C. This may only be modified on the sensor.
		reliability	enumerated	O	C	N	always false (0)
		status_flags					
		in_alarm	boolean	R	C	N	always false (0)
		fault	boolean	R	C	N	always false (0)
	overridden	boolean	R	C	N	always false (0)	
	out_of_service	boolean	R	C	N	always false (0)	
	units	enumerated	R	C	N	96 (ppm) or 98 (percent) or 95 (no_units)	
	AlarmB	object_identifier		R	N	N	Modbus address * 256 + 4. For example an XCD at Modbus address 011 will appear as 2820 or 0x0B04.
		object_type	enumerated	R	C	N	analog_value (2)
		event_state	enumerated	R	C	N	normal (0)
		object_name	character string	R	N	N	"SSS GGGG AdAAA.AlarmB" where SSS is the sensor type, GGGG is the gas name and AAA is the Modbus address. Gas names are truncated to 4 characters. Values for sensor type are "XNX" or "XCD" For example, an XCD at address 11 with an H2S sensor will populate this object name with "XCD H2S Ad011.AlarmB"
		out_of_service	boolean	R	C	N	FALSE
		present_value	real	R	N	N	Alarm2 threshold copied from sensor through the 301C. This may only be modified on the sensor.
		reliability	enumerated	O	C	N	no_fault_detected (0)
status_flags							
in_alarm		boolean	R	C	N	always false (0)	
fault		boolean	R	C	N	always false (0)	
overridden	boolean	R	C	N	always false (0)		
out_of_service	boolean	R	C	N	always false (0)		
units	enumerated	R	C	N	96 (ppm) or 98 (percent) or 95 (no_units)		
Notes	1 --	'R' indicates that this property is required by ASHRAE Standard 135 'O' indicates that the property is optional in ASHRAE Standard 135					
	2 --	'C' indicates the property is hard-coded as a constant 'N' indicates the property is stored in non-volatile memory					

Objects for 301EM

Group	Property	Data Type	Required ¹	Storage Type ²	BACnet Writeable?	Value	
analog_input Gas (One instance per sensor on the 301EM.)	object_identifier		R	C	N	TxNumber * 256 + 1. The TxNumber is the Modbus address plus the sensor number in the 301EM. For example, sensor 2 on a 301EM at Modbus address 030 will appear as 7937 or 0x1F01.	
	object_type	enumerated	R	C	N	analog_input (0)	
	event_state	enumerated	R	R	N	not meaningful	
	object_name	character string	R	N	N	"VA301EM GGGG AdXXX.GGGG" where GGGG is the gas name and XXX is the Modbus address. Values for gas name include "R11" and "NH3".	
	out_of_service	boolean	R	R	N	FALSE	
	present_value	real	R	R	N	Gas reading	
	reliability	enumerated	O	R	N	As appropriate reports no_fault_detected (0), no_sensor (1), or unreliable other (7)	
	status_flags					Fault is detected within 60 seconds	
	in_alarm	boolean	R	R	N	not meaningful	
	fault	boolean	R	R	N	if faulty "true" (1) else "false" (0)	
	overridden	boolean	R	R	N	"false" (0)	
	out_of_service	boolean	R	R	N	"false" (0)	
	units	enumerated	R	N	N	From 301EM, usually ppm (96)	
	Analog Values (six instances for each sensor on the 301EM, up to 120). Amin, Amax, Bmin, Bmax, Cmin, Cn	object_identifier		R	N	N	For Amin, TxNumber * 256 + 2, For Amax, TxNumber * 256 + 3, For Bmin, TxNumber * 256 + 4, For Bmax, TxNumber * 256 + 5, For Cmin, TxNumber * 256 + 6, For Cmax, TxNumber * 256 + 7. The TxNumber is the Modbus address plus the sensor number in the 301EM.
		object_type	enumerated	R	C	N	analog_value (2)
event_state		enumerated	R	C	N	not meaningful.	
object_name		character string	R	N	N	"VA301EM GGGG AdXXX.LLLL" where GGGG is the gas name, XXX is the Modbus address plus the sensor number in the 301EM and LLLL is a member of the set {Amin, Amax, Bmin, Bmax, Cmin and Cmax}.	
out_of_service		boolean	R	C	N	FALSE	
present_value		real	R	N	N	Writing alarm thresholds over BACnet not supported.	
reliability		enumerated	O	C	N	not meaningful.	
status_flags							
in_alarm		boolean	R	C	N	not meaningful.	
fault		boolean	R	C	N	not meaningful.	
overridden		boolean	R	C	N	always false (0)	
out_of_service		boolean	R	C	N	always false (0)	
units		enumerated	R	C	N	ppm (96) or % (98)	
Notes							
		1 --					'R' indicates that this property is required by ASHRAE Standard 135
						'O' indicates that the property is optional in ASHRAE Standard 135	
	2 --					'C' indicates the property is hard-coded as a constant	
						'N' indicates the property is stored in non-volatile memory	
						'R' indicate the property is computed constantly and stored in RAM.	

Objects for 301EM continued

Group	Property	Data Type	Required ¹	Storage Type ²	BACnet Writeable?	Value	
Binary Values (Four instances per 301EM, regardless of number of sensors.)	rel1 to rel4	object_identifier	R	C	N	For rel1, Modbus address * 256 + 8, For rel2, Modbus address * 256 + 9, For rel3, Modbus address * 256 + 10, For rel4, Modbus address * 256 + 11	
		object_type	enumerated	R	C	N	binary_values (5)
		event_state	enumerated	R	C	N	normal (0)
		object_name	character string	R	N	N	"VA301EM GGGG AdXXX.ReIL" where GGGG is the gas name, XXX is the Modbus address and L is the relay number.
		out_of_service	boolean	R	C	N	FALSE
		present_value	enumerated	R	R	N	current state of relay
		reliability	enumerated	0	C	N	not meaningful.
		active_text	character string	O	C	N	"ON"
		status_flags					
		in_alarm	boolean	R	C	N	not meaningful.
	fault	boolean	R	C	N	not meaningful.	
	overridden	boolean	R	R	N	always "false" (0)	
	out_of_service	boolean	R	R	N	always "false" (0)	
	buzzer.out1 to out3	object_identifier		R	C	N	For Buzzer, Modbus address * 256 + 24, For Out1, Modbus address * 256 + 25, For Out2, Modbus address * 256 + 26, For Out3, Modbus address * 256 + 27
		object_type	enumerated	R	C	N	binary_value (5)
		event_state	enumerated	R	C	N	normal (0)
		object_name	character string	R	N	N	"VA301EM GGGG AdXXX.buzzz" "VA301EM GGGG AdXXX.out1" "VA301EM GGGG AdXXX.out2" "VA301EM GGGG AdXXX.out3" where GGGG is the gas name, and XXX is the Modbus address.
		out_of_service	boolean	R	C	N	FALSE
		polarity	enumerated	R	C	N	always Normal (0)
		present_value	enumerated	R	R	N	state of buzzer and three 24VDC outputs.
reliability		enumerated	0	C	N	not meaningful.	
relinquish_default			R	C	N	not meaningful.	
status_flags							
in_alarm	boolean	R	C	N	not meaningful.		
fault	boolean	R	C	N	not meaningful.		
overridden	boolean	R	C	N	always "false" (0)		
out_of_service	boolean	R	C	N	always "false" (0)		
Notes							
1 --	'R' indicates that this property is required by ASHRAE Standard 135						
	'O' indicates that the property is optional in ASHRAE Standard 135						
2 --	'C' indicates the property is hard-coded as a constant						
	'N' indicates the property is stored in non-volatile memory						
	'R' indicate the property is computed constantly and stored in RAM.						

EC-FX

Group	Property	Data Type	Required ¹	Storage Type ²	BACnet Writeable?	Value
Analog Input	object_identifier		R	C	N	Modbus address * 256 + 1. For example an EC-F9 at Modbus address 003 will appear as 769 or 0x0301.
	object_type	enumerated	R	C	N	analog_input (0)
	event_state	enumerated	R	R	N	If gas sensor fault Fault (1), else normal (0)
	object_name	character string	R	N	N	"EC-F9 GGGG AdXXX.GGGG" where GGGG is the gas name and XXX is the Modbus address. The gas name is often "NH3".
	out_of_service	boolean	R	R	N	FALSE
	present_value	real	R	R	N	Gas reading
	reliability	enumerated	O	R	N	As appropriate reports no_fault_detected (0) or unreliable other (7) Fault is detected within 60 seconds
	status_flags					
	in_alarm	boolean	R	R	N	If faulty "true" (1) else "false" (0)
	fault	boolean	R	R	N	If faulty "true" (1) else "false" (0)
	overridden	boolean	R	R	N	"false" (0)
	out_of_service	boolean	R	R	N	"false" (0)
	units	enumerated	R	N	N	Usually ppm (96)
	Analog Values	object_identifier		R	N	N
object_type		enumerated	R	C	N	analog_value (2)
event_state		enumerated	R	C	N	normal (0)
object_name		character string	R	N	N	"EC-F9 GGGG AdXXX.Amin" where GGGG is the gas name and XXX is the Modbus address. The gas name is often "NH3".
out_of_service		boolean	R	C	N	FALSE
present_value		real	R	N	Y	Gas threshold. Synchronization is maintained with the 301C and the EC-F9. Whichever value is written last is distributed to the other two locations.
reliability		enumerated	O	C	N	no_fault_detected (0)
status_flags						
in_alarm		boolean	R	C	N	always false (0)
fault		boolean	R	C	N	always false (0)
overridden		boolean	R	C	N	always false (0)
out_of_service		boolean	R	C	N	always false (0)
units		enumerated	R	C	N	Usually ppm (96)
Analog Values		object_identifier		R	N	N
	object_type	enumerated	R	C	N	analog_value (2)
	event_state	enumerated	R	C	N	normal (0)
	object_name	character string	R	N	N	"EC-F9 GGGG AdXXX.Amax" where GGGG is the gas name and XXX is the Modbus address. The gas name is often "NH3".
	out_of_service	boolean	R	C	N	FALSE
	present_value	real	R	N	Y	Gas threshold. Synchronization is maintained with the 301C and the EC-F9. Whichever value is written last is distributed to the other two locations.
	reliability	enumerated	O	C	N	no_fault_detected (0)
	status_flags					
	in_alarm	boolean	R	C	N	always false (0)
	fault	boolean	R	C	N	always false (0)
	overridden	boolean	R	C	N	always false (0)
	out_of_service	boolean	R	C	N	always false (0)
	units	enumerated	R	C	N	Usually ppm (96)
	Notes					
	1 --	"R" indicates that this property is required by ASHRAE Standard 135 "O" indicates that the property is optional in ASHRAE Standard 135				
	2 --	"C" indicates the property is hard-coded as a constant "N" indicates the property is stored in non-volatile memory "R" indicate the property is computed constantly and stored in RAM.				

continued...

EC-FX continued

Group	Property	Data Type	Required ¹	Storage Type ²	BACnet Writeable?	Value	
Analog Values	Bmin	object_identifier	R	N	N	Modbus address * 256 + 4. For example an EC-F9 at Modbus address 003 will appear as 772 or 0x0304.	
		object_type	enumerated	R	C	N	analog_value (2)
		event_state	enumerated	R	C	N	normal (0)
		object_name	character string	R	N	N	"EC-F9 GGGG AdXXX_Bmin" where GGGG is the gas name and XXX is the Modbus address. The gas name is often "NH3".
		out_of_service	boolean	R	C	N	FALSE
		present_value	real	R	N	Y	Gas threshold. Synchronization is maintained with the 301C and the EC-F9. Whichever value is written last is distributed to the other two locations.
		reliability	enumerated	O	C	N	no_fault_detected (0)
		status_flags					
		in_alarm	boolean	R	C	N	always false (0)
	fault	boolean	R	C	N	always false (0)	
	overridden	boolean	R	C	N	always false (0)	
	out_of_service	boolean	R	C	N	always false (0)	
	units	enumerated	R	C	N	Usually ppm (96)	
	Bmax	object_identifier		R	N	N	Modbus address * 256 + 5. For example an EC-F9 at Modbus address 003 will appear as 773 or 0x0305.
		object_type	enumerated	R	C	N	analog_value (2)
		event_state	enumerated	R	C	N	normal (0)
		object_name	character string	R	N	N	"EC-F9 GGGG AdXXX_Bmax" where GGGG is the gas name and XXX is the Modbus address. The gas name is often "NH3".
		out_of_service	boolean	R	C	N	FALSE
		present_value	real	R	N	Y	Gas threshold. Synchronization is maintained with the 301C and the EC-F9. Whichever value is written last is distributed to the other two locations.
reliability		enumerated	O	C	N	no_fault_detected (0)	
status_flags							
in_alarm		boolean	R	C	N	always false (0)	
fault		boolean	R	C	N	always false (0)	
overridden	boolean	R	C	N	always false (0)		
out_of_service	boolean	R	C	N	always false (0)		
units	enumerated	R	C	N	Usually ppm (96)		
Notes							
1 --	'R' indicates that this property is required by ASHRAE Standard 135						
	'O' indicates that the property is optional in ASHRAE Standard 135						
2 --	'C' indicates the property is hard-coded as a constant						
	'N' indicates the property is stored in non-volatile memory						
	'R' indicate the property is computed constantly and stored in RAM.						
						continued...	

EC-FX continued

Group	Property	Data Type	Required ¹	Storage Type ²	BACnet Writeable?	Value	
Analog Values	Cmin	object_identifier	R	N	N	Modbus address * 256 + 6. For example an EC-F9 at Modbus address 003 will appear as 774 or 0x0306.	
		object_type	enumerated	R	C	N	analog_value (2)
		event_state	enumerated	R	C	N	normal (0)
		object_name	character string	R	N	N	"EC-F9 GGGG AdXXX.Cmin" where GGGG is the gas name and XXX is the Modbus address. The gas name is often "NH3".
		out_of_service	boolean	R	C	N	FALSE
		present_value	real	R	N	Y	Gas threshold. Synchronization is maintained with the 301C and the EC-F9. Whichever value is written last is distributed to the other two locations.
		reliability	enumerated	O	C	N	no_fault_detected (0)
		status_flags					
		in_alarm	boolean	R	C	N	always false (0)
		fault	boolean	R	C	N	always false (0)
		overridden	boolean	R	C	N	always false (0)
		out_of_service	boolean	R	C	N	always false (0)
		units	enumerated	R	C	N	Usually ppm (96)
		Analog Values	Cmax	object_identifier	R	N	N
object_type	enumerated			R	C	N	analog_value (2)
event_state	enumerated			R	C	N	normal (0)
object_name	character string			R	N	N	"EC-F9 GGGG AdXXX.Cmax" where GGGG is the gas name and XXX is the Modbus address. The gas name is often "NH3".
out_of_service	boolean			R	C	N	FALSE
present_value	real			R	N	Y	Gas threshold. Synchronization is maintained with the 301C and the EC-F9. Whichever value is written last is distributed to the other two locations.
reliability	enumerated			O	C	N	no_fault_detected (0)
status_flags							
in_alarm	boolean			R	C	N	always false (0)
fault	boolean			R	C	N	always false (0)
overridden	boolean			R	C	N	always false (0)
out_of_service	boolean			R	C	N	always false (0)
units	enumerated			R	C	N	Usually ppm (96)
Notes							
	1 --	'R' indicates that this property is required by ASHRAE Standard 135					
		'O' indicates that the property is optional in ASHRAE Standard 135					
	2 --	'C' indicates the property is hard-coded as a constant					
		'N' indicates the property is stored in non-volatile memory					
		'R' indicate the property is computed constantly and stored in RAM.					

420MDBS_IR-F9

Group	Property	Data Type	Required ¹	Storage Type ²	BACnet Writeable?	Value	
analog_in gas	object_identifier		R	C	N	Modbus address * 256 + 1. For example an 420MDBS at Modbus address 002 will appear as 513 or 0x0201.	
	object_type	enumerated	R	C	N	analog_input (0)	
	event_state	enumerated	R	R	N	if gas sensor fault Fault (1), else normal (0)	
	object_name	character string	R	N	N	"420MDBS GGGG AdXXX.GGGG" where GGGG is the gas name and XXX is the Modbus address. Values for gas name include "NH3".	
	out_of_service	boolean	R	R	N	FALSE	
	present_value	real	R	R	N	Gas reading	
	reliability	enumerated	O	R	N	As appropriate reports no_fault_detected (0) or unreliable other (7)	
	status_flags						
		in_alarm	boolean	R	R	N	if alarm or fault "true" (1) else "false" (0)
		fault	boolean	R	R	N	if faulty "true" (1) else "false" (0)
		overridden	boolean	R	R	N	"false" (0)
		out_of_service	boolean	R	R	N	"false" (0)
		units	enumerated	R	N	N	Depends on configuration of 420MDBS factory configuration or 301C configuration, usually ppm (96)
	Notes						
	1 --	'R' indicates that this property is required by ASHRAE Standard 135					
		'O' indicates that the property is optional in ASHRAE Standard 135					
	2 --	'C' indicates the property is hard-coded as a constant					
		'N' indicates the property is stored in non-volatile memory					
		'R' indicate the property is computed constantly and stored in RAM.					

continued...

420MDBS_IR-F9 continued

Group	Property	Data Type	Required ¹	Storage Type ²	BACnet Writeable?	Value	
Analog Values	Amin	object_identifier	R	N	N	Modbus address * 256 + 2. For example an 420MDBS at Modbus address 002 will appear as 514 or 0x0202.	
		object_type	enumerated	R	C	N	analog_value (2)
		event_state	enumerated	R	C	N	normal (0)
		object_name	character string	R	N	N	"420MDBS GGGG AdXXX.Amin" where GGGG is the gas name and XXX is the Modbus address. Values for gas name include "NH3".
		out_of_service	boolean	R	C	N	FALSE
		present_value	real	R	N	Y	Gas threshold from 301C. Synchronization is maintained with the 301C and the 420MDBS. Whichever value is written last is distributed to the other two locations.
		reliability	enumerated	O	C	N	no_fault_detected (0)
		status_flags					
		in_alarm	boolean	R	C	N	always false (0)
		fault	boolean	R	C	N	always false (0)
	overridden	boolean	R	C	N	always false (0)	
	out_of_service	boolean	R	C	N	always false (0)	
	units	enumerated	R	C	N	Depends on configuration of 420MDBS factory configuration or 301C configuration, usually ppm (96)	
	Amax	object_identifier		R	N	N	Modbus address * 256 + 3. For example an 420MDBS at Modbus address 002 will appear as 515 or 0x0203.
		object_type	enumerated	R	C	N	analog_value (2)
		event_state	enumerated	R	C	N	normal (0)
		object_name	character string	R	N	N	"420MDBS GGGG AdXXX.Amin" where GGGG is the gas name and XXX is the Modbus address. Values for gas name include "NH3".
		out_of_service	boolean	R	C	N	FALSE
		present_value	real	R	N	Y	Gas threshold from 301C. Synchronization is maintained with the 301C and the 420MDBS. Whichever value is written last is distributed to the other two locations.
		reliability	enumerated	O	C	N	no_fault_detected (0)
status_flags							
in_alarm		boolean	R	C	N	always false (0)	
fault		boolean	R	C	N	always false (0)	
overridden	boolean	R	C	N	always false (0)		
out_of_service	boolean	R	C	N	always false (0)		
units	enumerated	R	C	N	Depends on configuration of 420MDBS factory configuration or 301C configuration, usually ppm (96)		
Notes							
1 --	'R' indicates that this property is required by ASHRAE Standard 135						
	'O' indicates that the property is optional in ASHRAE Standard 135						
2 --	'C' indicates the property is hard-coded as a constant						
	'N' indicates the property is stored in non-volatile memory						
	'R' indicate the property is computed constantly and stored in RAM.						
						continued...	

420MDBS_IR-F9 continued

Group	Property	Data Type	Required ¹	Storage Type ²	BACnet Writeable?	Value	
Analog Values	Bmin	object_identifier	R	N	N	Modbus address * 256 + 4. For example an 420MDBS at Modbus address 002 will appear as 516 or 0x0204.	
		object_type	enumerated	R	C	N	analog_value (2)
		event_state	enumerated	R	C	N	normal (0)
		object_name	character string	R	N	N	"420MDBS GGGG AdXXX.Amin" where GGGG is the gas name and XXX is the Modbus address. Values for gas name include "NH3".
		out_of_service	boolean	R	C	N	FALSE
		present_value	real	R	N	Y	Gas threshold from 301C. Synchronization is maintained with the 301C and the 420MDBS. Whichever value is written last is distributed to the other two locations.
		reliability	enumerated	O	C	N	no_fault_detected (0)
		status_flags					
		in_alarm	boolean	R	C	N	always false (0)
	fault	boolean	R	C	N	always false (0)	
	overridden	boolean	R	C	N	always false (0)	
	out_of_service	boolean	R	C	N	always false (0)	
	units	enumerated	R	C	N	Depends on configuration of 420MDBS factory configuration or 301C configuration, usually ppm (96)	
	Bmax	object_identifier		R	N	N	Modbus address * 256 + 5. For example an 420MDBS at Modbus address 002 will appear as 517 or 0x0205.
		object_type	enumerated	R	C	N	analog_value (2)
		event_state	enumerated	R	C	N	normal (0)
		object_name	character string	R	N	N	"420MDBS GGGG AdXXX.Amin" where GGGG is the gas name and XXX is the Modbus address. Values for gas name include "NH3".
		out_of_service	boolean	R	C	N	FALSE
present_value		real	R	N	Y	Gas threshold from 301C. Synchronization is maintained with the 301C and the 420MDBS. Whichever value is written last is distributed to the other two locations.	
reliability		enumerated	O	C	N	no_fault_detected (0)	
status_flags							
in_alarm		boolean	R	C	N	always false (0)	
fault	boolean	R	C	N	always false (0)		
overridden	boolean	R	C	N	always false (0)		
out_of_service	boolean	R	C	N	always false (0)		
units	enumerated	R	C	N	Depends on configuration of 420MDBS factory configuration or 301C configuration, usually ppm (96)		
Notes							
1 --	'R' indicates that this property is required by ASHRAE Standard 135						
	'O' indicates that the property is optional in ASHRAE Standard 135						
2 --	'C' indicates the property is hard-coded as a constant						
	'N' indicates the property is stored in non-volatile memory						
	'R' indicate the property is computed constantly and stored in RAM.						

301ADI

Group	Property	Data Type	Required ¹	Storage Type ²	BACnet Writeable?	Value
analog_inputs (Up to 16 if configured enabled on the 301ADI user interface.)	object_identifier		R	C	N	(Modbus address+channel number) * 256 - 255, where channel number is 1 to 16. For example analog input 7 from a 301ADI at address 097 will appear as 26369 or 0x6107.
	object_type	enumerated	R	C	N	analog_input (0)
	event_state	enumerated	R	R	N	not meaningful.
	object_name	character string	R	N	N	"VA301ADI AI.CC AdXXX.AI.CC" where CC is the channel number from 1 to 16 and XXX is the Modbus address.
	out_of_service	boolean	R	R	N	FALSE
	present_value	real	R	R	N	Reading from 301C, mA by default. Scaling in the 301C is supported.
	reliability	enumerated	O	R	N	not meaningful.
	status_flags					
	in_alarm	boolean	R	R	N	not meaningful.
	fault	boolean	R	R	N	"false" (0)
	overridden	boolean	R	R	N	"false" (0)
	out_of_service	boolean	R	R	N	"false" (0)
	units	enumerated	R	N	N	mA (02) by default. Reconfiguration in the 301C is possible. New units may not propagate until a power cycle.
	Binary Inputs (up to 8) (Up to 8 if configured enabled on the 301ADI user interface.)	object_identifier		R	N	N
object_type		enumerated	R	C	N	binary_input (3)
event_state		enumerated	R	C	N	normal (0)
object_name		character string	R	N	N	"VA301ADI BI.CC AdXXX.BI.CC" where CC is the channel number from 1 to 16 and XXX is the Modbus address plus the channel number plus 15.
out_of_service		boolean	R	C	N	FALSE
present_value		real	R	N	N	0 if input is an open circuit, 1 if input is shorted to VDC out
reliability		enumerated	O	C	N	no_fault_detected (0)
status_flags						
in_alarm		boolean	R	C	N	always false (0)
fault		boolean	R	C	N	always false (0)
overridden		boolean	R	C	N	always false (0)
out_of_service		boolean	R	C	N	always false (0)
polarity		boolean	R	C	N	always 0
active_text		character string	O	C	N	"ON"
	Notes					
	1 --					'R' indicates that this property is required by ASHRAE Standard 135 'O' indicates that the property is optional in ASHRAE Standard 135
	2 --					'C' indicates the property is hard-coded as a constant 'N' indicates the property is stored in non-volatile memory 'R' indicate the property is computed constantly and stored in RAM.

301R

Group	Property	Data Type	Required ¹	Storage Type ²	BACnet Writeable?	Value
Binary Outputs rel1 to rel8	object_identifier		R	C	N	RelayNumber + Modbus address * 256 + 7. For example Relay 4 in a 301R at Modbus address 095 will appear as 24331 or 0x5F0B.
	object_type	enumerated	R	C	N	binary_output (4)
	event_state	enumerated	R	C	N	normal (0)
	object_name	character string	R	N	N	"VA301R AdXXX.relR" where XXX is the Modbus address and R is the relay number.
	out_of_service	boolean	R	C	N	FALSE
	polarity	enumerated	R	C	N	always Normal (0)
	present_value	enumerated	R	R	Only Rly 1to4. Not Rly 5to8.	True state of the relays. These take the value of the highest-priority BACnet command. If no BACnet command, this takes the value of the associated event.
	priority_array		R	R	N	last value written
	reliability	enumerated	0	C	N	no_fault_detected (0)
	relinquish_default		R	C	N	not meaningful
	active_text	character string	O	C	N	"ON"
	status_flags					
	in_alarm	boolean	R	C	N	always "false" (0)
	fault	boolean	R	C	N	always "false" (0)
	overridden	boolean	R	R	N	always "false" (0)
	out_of_service	boolean	R	R	N	always "false" (0)
Notes						
1 --	'R' indicates that this property is required by ASHRAE Standard 135					
	'O' indicates that the property is optional in ASHRAE Standard 135					
2 --	'C' indicates the property is hard-coded as a constant					
	'N' indicates the property is stored in non-volatile memory					
	'R' indicate the property is computed constantly and stored in RAM.					

Protocol Implementation Conformance Statement

(Normative)

BACnet Protocol Implementation Conformance Statement

Date : August 1, 2005

Vendor Name : Honeywell Analytics

Product Name : 301C -BIP

Product Model Number: N/A

Applications Software Version : 1.0

Firmware Revision : 1.0

BACnet Protocol Revision : 1.0

Product Description:

The 301C -BIP has a module that uses BACnet communication. As such, the components of a Vulcain network can be connected to a BACnet network via the 301C controller.

BACnet Standardized Device Profile (Annex L)

- BACnet Operator Workstation (B-OWS)_
- BACnet Building Controller (B-BC)
- BACnet Advanced Application Controller (B-AAC)_
- BACnet Application Specific Controller (B-ASC)
- BACnet Smart Sensor (B-SS)
- BACnet Smart Actuator (B-SA)

List all BACnet Interoperability Building Blocks Supported (Annex K)

Data Sharing

- Data Sharing-ReadProperty-A (DS-RP-A)
- Data Sharing-ReadProperty-B (DS-RP-B)
- Data Sharing-ReadPropertyMultiple-A (DS-RPM-A)
- Data Sharing-ReadPropertyMultiple-B (DS-RPM-B)
- Data Sharing-ReadPropertyConditional-A (DS-RPC-A)
- Data Sharing-ReadPropertyConditional-B (DS-RPC-B)
- Data Sharing-WriteProperty-A (DS-WP-A)
- Data Sharing-WriteProperty-B (DS-WP-B)
- Data Sharing-WritePropertyMultiple-A (DS-WPM-A)
- Data Sharing-WritePropertyMultiple-B (DS-WPM-B)
- Data Sharing-COV-A (DS-COV-A)
- Data Sharing-COV-B (DS-COV-B)
- Data Sharing-COVP-A (DS-COVP-A)
- Data Sharing-COVP-B (DS-COVP-B)
- Data Sharing-COV-Unsolicited-A (DS-COVU-A)
- Data Sharing-COV-Unsolicited-B (DS-COVU-B)

Scheduling

- Scheduling-A (SCHED-A)
- Scheduling-Internal-B (SCHED-I-B)
- Scheduling-External-A (SCHED-E-B)

Trending

- Viewing and Modifying Trends-A (T-VMT-A)
- Trending-Viewing and Modifying Trends-Internal-B (T-VMT-I-B)
- Trending-Viewing and Modifying Trends-External-B (T-VMT-E-B)
- Trending-Automated Trend Retrieval-A (T-ATR-A)
- Trending-Automated Trend Retrieval-B (T-ATR-B)

Network Management

- Network Management-Connection Establishment-A (NM-CE-A)
- Network Management-Connection Establishment-B (NM-CE-B)
- Network Management-Router Configuration-A (NM-RC-A)
- Network Management-Router Configuration-B (NM-RC-B)

Alarm and Event Management

- Alarm and Event-Notification-A (AE-N-A)
- Alarm and Event-Notification Internal-B (AE-N-I-B)
- Alarm and Event-Notification External-A (AE-N-E-B)
- Alarm and Event-ACK-A (AE-ACK-A)
- Alarm and Event-ACK-B (AE-ACK-B)
- Alarm and Event-Alarm Summary-A (AE-ASUM-A)
- Alarm and Event-Alarm Summary-B (AE-ASUM-B)
- Alarm and Event-Enrollment Summary-A (AE-ESUM-A)
- Alarm and Event-Enrollment Summary-B (AE-ESUM-B)
- Alarm and Event-Information-A (AE-INFO-A)
- Alarm and Event-Information-B (AE-INFO-B)
- Alarm and Event-LifeSafety-A (AE-LS-A)
- Alarm and Event-LifeSafety-B (AE-LS-B)

Device Management

- Device Management-Dynamic Device Binding-A (DM-DDB-A)
- Device Management-Dynamic Device Binding-B (DM-DDB-B)
- Device Management-Dynamic Object Binding-A (DM-DOB-A)
- Device Management-Dynamic Object Binding-B (DM-DOB-B)
- Device Management-DeviceCommunicationControl-A (DM-DCC-A)
- Device Management-DeviceCommunicationControl-B (DM-DCC-B)
- Device Management-Private Transfer-A (DM-PT-A)
- Device Management-Private Transfer-B (DM-PT-B)
- Device Management-Text Message-A (DM-TM-A)
- Device Management-Text Message-B (DM-TM-B)
- Device Management-TimeSynchronization-A (DM-TS-A)
- Device Management-TimeSynchronization-B (DM-TS-B)
- Device Management-UTCTimeSynchronization-A (DM-UTC-A)
- Device Management-UTCTimeSynchronization-B (DM-UTC-B)

- Device Management-ReinitializeDevice-A (DM-RD-A)
- Device Management-ReinitializeDevice-B (DM-RD-B)
- Device Management-Backup and Restore-A (DM-BR-A)
- Device Management-Backup and Restore-B (DM-BR-B)
- Device Management-List Manipulation-A (DM-LM-A)
- Device Management-List Manipulation-B (DM-LM-B)
- Device Management-Object Creation and Deletion-A (DM-OCD-A)
- Device Management-Object Creation and Deletion-B (DM-OCD-B)
- Device Management-Virtual Terminal-A (DM-VT-A)
- Device Management-Virtual Terminal-B (DM-VT-B)

Segmentation Capability :

- Segmented requests supported Window Size

- Segmented responses supported Window Size : Take maximum
Windows size supported by the other device

Standard Object Types Supported :

Analog Input	For all objects
Analog Output	1) cannot be dynamically createable using Create Object service
Analog Value	2) cannot be dynamically deletable using DeleteObject service
Binary Input	3) No additional writable properties exist
Binary Output	4) No proprietary properties exist
Binary Value	5) No range restriction
Device	

Data Link Layer Options

- BACnet IP, (Annex J)
- BACnet IP, (Annex J), Foreign Device
- ISO 8802-3, Ethernet (Clause 7)

- ANSI/ATA 878.1, 2.5 Mb. ARCNET (Clause 8)
- ANSI/ATA 878.1, RS-485 ARCNET (Clause 8), baud rate(s)
- MS/TP master (Clause 9), baud rate(s):
- MS/TP slave (Clause 9), baud rate(s):
- Point-To-Point, EIA 232 (Clause 10), baud rate(s):
- Point-To-Point, modem, (Clause 10), baud rate(s):
- LonTalk, (Clause 11), medium:
- Other:

Device Address Binding :

Is static device binding supported? (This is currently necessary for two-way communication with MS/TP slaves and certain other devices.)

- Yes No

Networking Options

- Router, BACnet / Modbus.
- Annex H, BACnet Tunneling Router over IP
- BACnet/IP Broadcast Management Device (BBMD)

Does the BBMD support registrations by Foreign Devices?

- Yes No

Character Sets Supported

Indicating support for multiple character sets does not imply that they can all be supported simultaneously.

- ANSI X3.4 IBM™/Microsoft™ DBCS
- ISO 8859-1
- ISO 10646 (UCS-2) ISO 10646 (UCS-4)
- JIS C 6226

If this product is a communication gateway, describe the types of non-BACnet equipment/networks(s) that the gateway supports :
none

10. Wireless network.

Not supported.

Specifications

Power requirements 301C	17-27 Vac, 50/60 Hz, 8.64 VA 18-36 Vdc, 350mA @ 24 Vdc (8.4 VA)
Operating temperature range	-20°C to 50°C (-4°F to 122°F)
Operating humidity range	0 to 95% RH (non-condensing)
Operating altitude	Up to 3000 m (9843 ft)
Network capacity	Up to 96 transmitters, 32 per channel Channels 1, 2 = Modbus and Vulbus Channel 3 = Modbus only
Communication	Up to 609m (2,000 ft) per channel
User interface	Graphic 122 x 32 dot matrix backlit display User friendly keypad
Visual indicators	Power Green LED Alarm A, B, C Red LED Fault Amber LED Tx Amber LED Rx Green LED
Outputs	4 DPDT relays
Output rating	5A, 30Vdc or 250 Vac (resistive load)
Audible alarm	65dBA at 1 m (3 ft)
Time delays	Programmable Before and After delays
Battery	3 volt lithium battery
Enclosure	ABS-polycarbonate - indoor use
Dimensions (HxWxD)	28 x 20.3 x 7cm (7.99" x 11.02" x 2.76")
Certifications	ANSI/UL 61010-1 CAN/CSA C22.2 No. 61010-1 ETL 116662

Limited Warranty

Limited Warranty

Honeywell Analytics, Inc. warrants to the original purchaser and/or ultimate customer ("Purchaser") of Vulcain products ("Product") that if any part thereof proves to be defective in material or workmanship within twelve (12) months, such defective part will be repaired or replaced, free of charge, at Honeywell Analytics' discretion if shipped prepaid to Honeywell Analytics at 405 Barclay Blvd, Lincolnshire IL 60069 USA, or 3580 Rue Isabelle Unit 100 Brossard, Quebec, Canada J4Y 2R3, in a package equal to or in the original container. The Product will be returned freight prepaid and repaired or replaced if it is determined by Honeywell Analytics that the part failed due to defective materials or workmanship. The repair or replacement of any such defective part shall be Honeywell Analytics' sole and exclusive responsibility and liability under this limited warranty.

Re-Stocking Policy

The following restocking fees will apply when customers return products for credit:

- 15% restocking fee will be applied if the product is returned within **1 month** following the shipping date
- 30% restocking fee will be applied if the product is returned within **3 months** following the shipping date

A full credit (less restocking fee) will only be issued if the product is in perfect working condition. If repairs are required on the returned product, the cost of these repairs will be deducted from the credit to be issued.

No credits will be issued beyond the three month period.

Exclusions

A. If Gas sensors are part of the Product, the gas sensor is covered by a twelve (12) month limited warranty of the manufacturer.

B. If gas sensors are covered by this limited warranty, the gas sensor is subject to inspection by Honeywell Analytics for extended exposure to excessive gas concentrations if a claim by the Purchaser is made under this limited warranty. Should such inspection indicate that the gas sensor has been expended rather than failed prematurely, this limited warranty shall not apply to the Product.

C. This limited warranty does not cover consumable items, such as batteries, or items subject to wear or periodic replacement, including lamps, fuses, valves, vanes, sensor elements, cartridges, or filter elements.

Warranty Limitation and Exclusion

Honeywell Analytics will have no further obligation under this limited warranty. All warranty obligations of Honeywell Analytics are extinguishable if the Product has been subject to abuse, misuse, negligence, or accident or if the Purchaser fails to perform any of the duties set forth in this limited warranty or if the Product has not been operated in accordance with instructions, or if the Product serial number has been removed or altered.

Disclaimer of Unstated Warranties

The warranty printed above is the only warranty applicable to this purchase. All other warranties, express or implied, including, but not limited to, the implied warranties of merchantability or fitness for a particular purpose are hereby disclaimed.

Limitation of Liability

It is understood and agreed that Honeywell Analytics' liability, whether in contract, in tort, under any warranty, in negligence or otherwise shall not exceed the amount of the purchase price paid by the purchaser for the product and under no circumstances shall Honeywell Analytics be liable for special, indirect, or consequential damages. The price stated for the product is a consideration limiting Honeywell Analytics' liability. No action, regardless of form, arising out of the transactions under this warranty may be brought by the purchaser more than one year after the cause of actions has occurred.

Contrôleur

301C

Manuel de l'utilisateur

M-510324
Révision 02
janvier 2015

Table des matières

Notes et marques de commerce	112
Définition des symboles	114
Introduction	116
Instructions d'installation	117
Installation murale.....	118
Détails de connexion.....	119
Connexions d'alimentation.....	120
Connexions de communication.....	120
Paramètres d'émetteurs spécifiques.....	121
Sortie relais.....	122
Instructions pour cavaliers	123
Démarrage.....	124
Enregistreur de données (carte SD)	124
Interface de programmation.....	125
Fonctions du clavier.....	125
Définition des DEL	126
Operation du système.....	126
Programmation du système.....	127
1. Menu Info Tx.....	130
Menu Ident	131
Type de produit et types de sondes	132
Com.....	133
Echelle (1 et 2)	134
Détection	135
Affichage	136
Alarme A, B et C	137
Entretien et Exploitation des Menus.....	138
Code de'Etat	139
Effacer Tx courant.....	139
Modification de l'adresse de l'émetteur	140
2. Menu groupes.....	141
Créer des groupes.....	142
Supprimer des groupes.....	143
3. Menu événement	144
Action	145
Délais	146
Délais mode latch.....	147
Conditions	148
Statut.....	153

(voir page suivante)

4. Menu Acquisition	154
Debuter et arreter log Tx	155
Débuter et arrêter log événement	156
5. Menu de copie	157
Configuration	158
Paramètres.....	159
Journal système	160
6. Menu de config	161
7. Menu de Réseau	166
Étalonnage à distance.....	167
8. Menu tests	171
Séquence de tests.....	173
Mode Normal.....	175
Mode Émetteur unique	175
Mode Débogage.....	175
Mode Simulation	176
9. Menu BACnet	177
Ordre de priorité des relais.....	181
APDU_segment_timeout.....	182
Module BACnet/IP.....	183
Device Object.....	184
Objets de base	185
IAQPoint2.....	186
E ³ Point	190
XNX et XCD	195
Objets du 301EM	197
EC-FX	199
420MDBS_IR-F9.....	202
301ADI	205
301R.....	206
Déclaration de conformité d'implémentation du protocole BACnet	207
10. Reseau sans-fil	212
Spécifications.....	213
Garantie limitée.....	214

Notes et marques de commerce

Droit d'auteur détenu par Honeywell International Inc.

Bien que les renseignements ci-présents sont fournis en toute bonne foi et présumés exacts, Honeywell décline toute garantie implicite quant à la qualité marchande et l'adéquation du produit à un usage particulier et n'offre aucune garantie expresse à l'exception du contenu des accords écrits avec et pour ses clients.

Honeywell ne peut, en aucun cas, être tenue responsable envers quiconque de tout dommage indirect, spécial ou consécutif. Les renseignements et les spécifications figurant dans le présent document sont modifiables sans préavis.





Ce manuel couvre la version logicielle 3.086 et le microprogramme en option, version 1.3.19, du module BACnet.

Honeywell Analytics
3580 rue Isabelle, Suite #100
Brossard, QC, Canada
J4Y 2R3

Tél. : +1 800 563 2967
+1 450 619 2450
Télécopie : +1 450 619 2525

Définition des symboles

Le tableau suivant répertorie les symboles utilisés dans ce document pour désigner certaines conditions :

Symbole	Définition
	MISE EN GARDE : Identifie les renseignements qui exigent une attention particulière
	CONSEIL : Identifie les conseils ou astuces, généralement relatifs à l'exécution d'une tâche, à l'intention de l'utilisateur
	RÉFÉRENCE _ INTERNE : Identifie une source supplémentaire de renseignements dans le manuel.
ATTENTION	Indique une situation qui, si elle n'est pas évitée, peut entraîner l'endommagement ou la perte de l'équipement ou du travail (données) sur le système, ou l'impossibilité d'exploiter correctement le processus.
	ATTENTION : Indique une situation potentiellement dangereuse qui, si elle n'est pas évitée, peut causer des blessures mineures ou modérées. Ce symbole peut également être utilisé pour attirer l'attention sur des pratiques non sécuritaires. ATTENTION : Ce symbole sur l'appareil renvoie l'utilisateur vers le manuel du produit pour plus de renseignements. Le symbole apparaît à côté des renseignements requis dans le manuel.
	AVERTISSEMENT : Indique une situation potentiellement dangereuse qui, si elle n'est pas évitée, peut causer des blessures graves ou la mort. AVERTISSEMENT : Ce symbole sur l'appareil renvoie l'utilisateur vers le manuel du produit pour plus de renseignements. Le symbole apparaît à côté des renseignements requis dans le manuel.

Introduction

La centrale 301C agit de centrale pour réseaux de détection de gaz, offrant une surveillance continue sur un maximum de 96 unités (avec un 301ADI) connectées. Puisque la centrale est configuré selon vos besoins, l'installation demande simplement le montage et la connexion. Aussitôt installée, la centrale vous permet de monitorer, d'ajuster ou de configurer un réseau complet d'unités.

Le 301C comporte l'option du coordonnateur sans-fil qui permet à la centrale de communiquer avec et de gérer les détecteurs de gaz sansfil (jusqu'à 60), tout en conservant toutes ses fonctionnalités précédentes.

Utilisation

Le 301C est une centrale créée pour monitorer la totalité d'un réseau de détection de gaz vingt quatre heures sur vingt quatre. La centrale offre la possibilité d'enregistrement de données, de création de fichiers journal pour toutes les concentrations et alarmes de transmetteurs aux fins d'analyse. Ces unités sont également munies de fonctions de groupes et de zones qui vous permettent d'interroger et de monitorer certains groupes ou certaines zones de transmetteurs.

Réception et verification

Lorsque vous recevez votre commande:

- Vérifiez le colis pour assurer qu'il n'y a aucun dommage.
- Ouvrez le colis avec soin.
- Trouvez le bordereau de marchandise ou le bon de commande et vérifiez que tout les articles apparaissant sur la liste sont bien dans le colis et ne sont pas endommagés.

Note: Si le colis ou la marchandise est endommagé, veuillez vous référer à la section Garantie à la fin de ce guide.

Instructions d'installation

Directives de base

Suivre les instructions minutieusement pour assurer le bon fonctionnement de l'équipement. À défaut de respecter les directives, Honeywell Analytics sera libéré de toute responsabilité :

- Installer les unités dans des endroits facilement accessible pour l'entretien
- Éviter les endroits où les unités pourraient être exposées aux vibrations
- Éviter d'installer les unités près de sources de perturbations électromagnétique
- Éviter d'installer les unités dans des endroits sujets à de grandes variations de température
- Consultez les réglementations et normes locales en vigueur, car
- celles-ci ont un impacte sur le choix d'emplacement.

Installation murale

Nous recommandons d'installer les centrales à 1.5m (5 pi.) du sol. Mesurer les distances tel qu'indiqué:

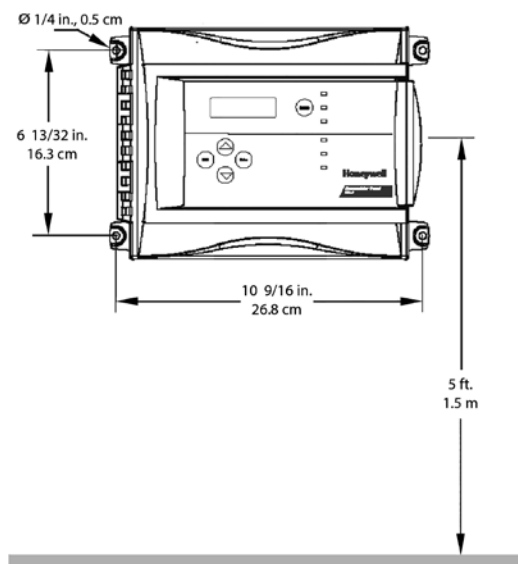

- Distance en hauteur $6 \frac{13}{32}$ " entre les trous
 - Distance en largeur entre les trous $10 \frac{9}{16}$ "
 - Perçer les trous $1/4$ po
 - Fixer la centrale avec les vis appropriées
- Le câblage de l'unité doit être enfilé dans les trous des pastilles
- poinçonnées (knock-out) situées en dessous de l'unité.

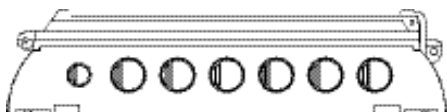

Passez les câbles de l'unité à travers les orifices à défoncer au bas de l'unité.

Détails de connexion

Le dessin ci-dessous démontre la connexion pour la centrale. Les descriptions de connecteurs et de connexions se trouvent dans les pages suivantes.

Les détails de câblage, alimentation, capacités, etc. se trouvent à la section Spéci_cations de ce guide.

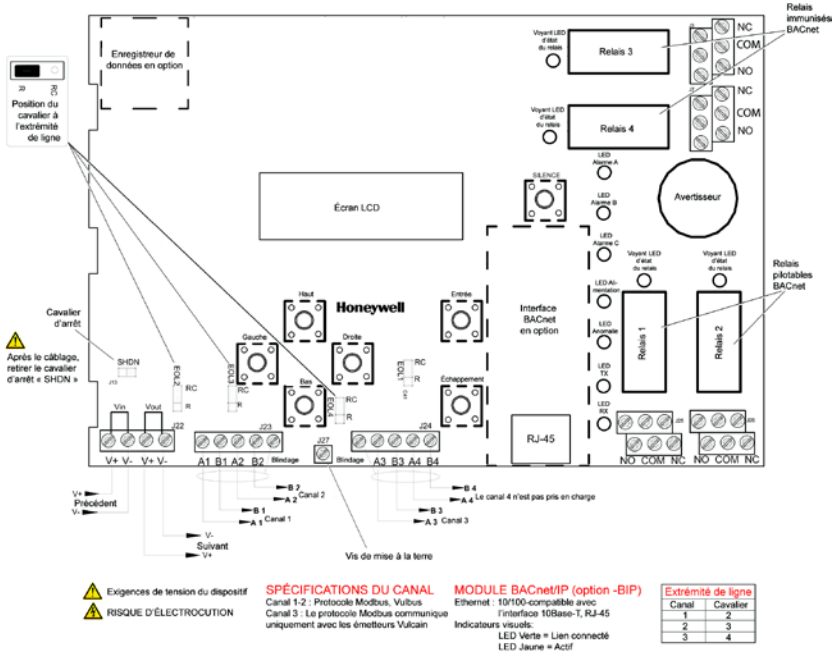

Les connecteurs, ou ports, de la carte (PCB) permettent d'effectuer la connexion du câblage à la centrale. Le câblage inclut l'alimentation, la communication, la connexion BACNet et les relais, chacun avec une position (et un chiffre) assignée sur la carte

- J22 Alimentation : Connecter l'alimentation à la centrale (voir Connexions d'alimentation pour les détails)
- J23, J24 Entrées Communication : Connecter les câbles de communication aux canaux 1 à 3.
- Sorties relais 1-4 : Selon la configuration désirée, connecter le câblage soit aux bornes N.O ou N.C.
- Cavalier SHDN : Placer le cavalier d'interruption d'alimentation sur les connecteurs pour réinitialiser le système.
- EOL Resistors 1-4 : Placer le cavalier sur les connecteurs pour créer une connexion et atténuer les échos de communication.
- .

Connexions d'alimentation

La centrale 301C nécessite une plage d'alimentation de 17-27 Vca, 50/60 Hz (8.64 VA), 18-36 Vcc, 350 mA @24 Vcc (8.4 VA). La polarisation n'importe pas, que ce soit en mode CA ou CC. Le système doit être mis à la terre sur le transformateur et un circuit dédié doit être utilisé.

Connexions de communication

Les câbles de communication doivent être mis à la terre sur le terminal blindé avec les fils torsadés et blindés paire Belden 2-24 AWG #9841 (ou équivalent).

Le câblage de réseau peut atteindre jusqu'à 609 m (2000 pi.) par canal.

La longueur d'une dérivation peut atteindre 20 m (65 pi.), jusqu'à un maximum de 40m (130 pi.) pour toutes les dérivations.

Le contrôleur de 301C communique avec des capteurs de gaz sur un réseau RS-485 Modbus. Cette ligne de transmission exige que les résistances de terminaison 120Ω^Ω soient montés aux deux extrémités de chaque segment de réseau pour absorber le signal, et donc d'éviter les réflexions. Heureusement, le contrôleur rend terminaison de réseau simple que résistances sont inclus sur la carte. Celles-ci peuvent être activées ou désactivées en positionnant correctement les cavaliers "EOL" tel qu'indiqué dans la figure à la page 119. Plus d'informations sur le câblage RS-485 est publié par Maxim Integrated dans les TUTORIAL 763 Guidelines for Proper Wiring of an RS-485 (TIA/EIA-485-A) Network

Paramètres d'émetteurs spécifiques

Les émetteurs Sensepoint XCD de Honeywell doivent être configurés pour un débit de 9 600 bauds, avec une adresse unique et avec aucune parité, tandis que les émetteurs universels XNX de Honeywell doivent être configurés pour un débit de 9 600 bauds et avec une adresse unique (la parité étant toujours paire pour ce type d'émetteurs). Vous trouverez des informations sur la configuration de chaque émetteur dans le manuel technique associé.

Certains capteurs nécessitent plusieurs adresses sur le 301C. Entre autres, lorsque de un à quatre capteurs sont reliés au 301EM celui-ci réserve automatiquement quatre adresses sur le 301C. Au-delà de quatre capteurs, le 301EM réservera sur le 301C, le nombre exact d'adresses correspondants au nombre de capteurs qui y sont reliés et ce jusqu'au maximum permis de 20 capteurs sur le 301EM. De plus, le IAQPOINT2 peut consommer jusqu'à 3 adresses sur le 301C lorsqu'il a les options température et humidité. Il faut donc prévoir les adresses requises sur le 301C en conséquence.

Sortie relais

La sortie relais supporte jusqu'à 5A à 30 Vcc ou 250 Vca (charge résistive seulement). Les relais peuvent activer les alarmes sonores et les lampes stroboscopiques. Consulter le dessin pour instructions de connexion. Chaque relais est configuré avec des valeurs par défaut, cependant, la configuration des relais peut être modifiée depuis le menu de programmation de la centrale.

Par défaut, tous les relais sont normalement non-énergisés et deviendront énergisés lors d'un évènement. Cependant, tous les relais peuvent être configurés, en bloc, en mode 'sécurité' (Failsafe) ou normalement énergisés. Dans ce mode 'sécurité' un évènement les rendra donc non-énergisés.

Si le relais est réglé à Normalement fermé, le relais est mis sous tension en même temps que la centrale et le dispositif connecté au relais est en fonction. Le relais se fermera lorsque la condition d'alarme précisée est atteinte.

Si le relais est réglé à Normalement ouvert, le relais demeure fermé lors de la mise sous tension de la centrale. Le dispositif connecté au relais fonctionnera seulement lorsque la condition d'alarme précisée est atteinte.

Note: Ces fonctions sont inversées lorsque le mode de sécurité Note: intégrée (Failsafe) est activé sur la centrale..

Instructions pour cavaliers

Les divers cavaliers de la carte (PCB) permettent d'effectuer certaines opérations manuellement:

- EOL 1-4 : Permet l'ajout de cavaliers de fin de ligne pour améliorer les signaux de communication. Mettre le cavalier en position R pour activer la terminaison fin-de-ligne. (Position R offre une terminaison à résistance, tandis que RC offre une terminaison de condensateur.)
- SHDN : Permet de réinitialiser ou de temporairement couper l'alimentation de la centrale. Cette fonction est utile pour effectuer des ajustements au câblage du système (alimentation interrompue pour sécurité).
- Relays
J29-J-32 : Permettent d'effectuer des tests sur les relais sans aucun impact sur les événements.

Démarrage

Assurer que tout le câblage est terminé et effectué selon les spécifications et les détails de connexion avant de mettre la centrale sous tension. Lorsque tout est sécuritaire, enlever le connecteur du cavalier SHDN pour alimenter l'unité (il y aura un délai de quelques secondes).

Enregistreur de données (carte SD)

L'option d'enregistrement de données (DLC) de la centrale collecte automatiquement les données et les enregistre sur une carte mémoire Flash (SDcard). Si la mémoire de la carte atteint sa capacité:

- L'enregistrement des données s'arrête
- Aucun avis n'est affiché à l'écran
- Le DEL de la carte clignote (le boîtier doit être ouvert pour le voir)

Consulter la section Acquisition pour de plus amples détails sur le démarrage et l'arrêt de la fonction enregistrement de données.

ATTENTION

Toujours désactiver la fonction d'enregistrement de données avant d'enlever la carte mémoire. Jamais enlever la carte lorsque le DEL est allumé.

Interface de programmation

Le panneau avant du 301C comporte un clavier de boutons poussoirs puis des indicateurs DEL.

Panneau 301C

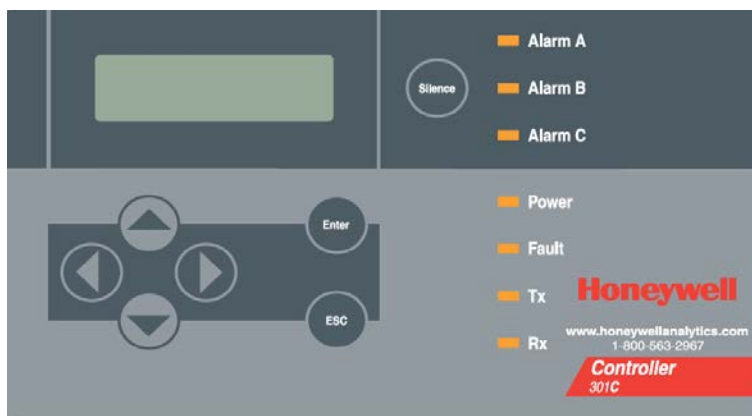

Fonctions du clavier

La centrale comporte 7 touches de clavier, soit:

- Flèches : Utilisées pour naviguer les divers menus de programmation (haut, bas, gauche, droite), ou pour ajuster le contraste de l'affichage (appuyer et maintenir enfoncé une touche de flèche (haut = plus clair, bas=plus sombre). Relâcher lorsque le contraste est satisfaisant.
- ESC : Permet de quitter un menu de programmation ou pour annuler une entrée ou une modification.
- Enter: Permet d'accéder au menu de programmation et de modifier (valider) les champs de configuration.
- Silence: Désactive l'alarme sonore de la centrale.

Définitions des DEL

La centrale comporte 7 DEL indiquant le statut de chaque fonction :

- Alarm A: Le DEL rouge clignotant indique qu'un événement est activé. Le DEL rouge continu indique qu'un ou plusieurs transmetteurs ont atteint un niveau d'alarme programmé.
- Alarm B et C: Le DEL rouge indique qu'un ou plusieurs transmetteurs ont atteint un niveau d'alarme programmé
- Power : Le DEL vert indique que l'unité est sous tension et fonctionnelle
- Fault : Le DEL jaune indique une faute (de communication, d'entretien ou un problème avec l'unité)
- Tx : Le DEL jaune clignotant indique que la centrale *transmet* des requêtes sur le canal de communication.
- Rx : Le DEL vert clignotant indique que la centrales *reçoit* des données.

Les fonctions sont liées aux paramètres configurés dans la centrale, ce que nous discuterons dans la section suivante.

Operation du système

Le système peut opérer en quatre (4) modes différents permettant d'utiliser, d'analyser, de déboguer et de simuler les actions du système. Ces modes sont : Normal, Tx simple, Débogage et Simulation. Le mode d'opération par défaut est Normal. Les autres modes sont accessible par le menu de programmation Tests (option 8 du Menu principale).

Note: Les services du systèmes peuvent êtres interrompus par certaines des opérations du menu.

Programmation du système

Le mode Normal de programmation du système propose plusieurs options de menu accessibles depuis l'écran du menu principal :

- 1 Info Tx: Permet de configurer les paramètres des transmetteurs
2. Groupes : Permet de configurer des groupes de transmetteurs
3. Evene. : Permet de configurer des événement et les actions liées aux événements
4. Acqui : Permet d'activer ou de désactiver la fonction d'enregistrement de données
5. Copie: Permet de copier des données ou des paramètres de la centrale à un ordinateur (et vice-versa) ou de transmetteur à transmetteur
6. Config : Permet de régler les paramètres du système et de modifier le mot de passe.
7. Reseau: Permet d'effectuer des actions sur le réseau Vulcain et de consulter les statistiques de communication.
8. Tests : Permet d'effectuer un essais sur les entrées et sorties (communication, événement, etc) et de valider l'opération de divers paramètres.
9. BACNet : Permet de configurer les paramètres BACNet d'un dispositif
10. Wireless: Ce ne est pas supporté.

Note: L'accès aux fonctions est protégé par mot de passe (par défaut est 2967).

Lorsqu'en opération normale, le système affiche l'écran ci-dessous et déroule des écrans d'informations pour chaque dispositif connecté à la centrale:

VA301C	Ver. 3.00
Ad: 1	Gr:0
Ev:0	
	
2007-01-17	13:18:18

Si un ou plusieurs appareils connectés à la centrale sont en mode d'alarme, la centrale affichera seulement l'écran principal et les écrans pour les appareils en mode d'alarme. Le cas échéant, il est nécessaire d'utiliser les flèches pour dérouler les écrans de tout autre dispositif.

L'écran d'information affiche également des icônes représentant certaines fonctions. Voici la liste des icônes et leurs descriptions:

Icône	Description
	BACNet : Indique la présence d'un module BACNet en communication avec la centrale.
	Erreur BACNet : Indique la présence d'un module BACNet, mais que la communication avec la centrale est en faute (erreur)
	Débogage : Indique que la centrale est en mode débogage (modes de TX unique, Débogage ou Simulation). SIM apparaît avec cette icône lorsque en mode de simulation.
	Log : Indique que soit le « Log Tx » ou le « Log even » est activé.
	Erreur de log : Indique qu'une erreur est survenue lors de l'enregistrement de Tx ou Even. Toutes fonctions d'enregistrements sont arrêtées.
	SDC : Indique la présence d'une carte mémoire (SDcard) en fonction. L'icône se remplit (de blanc à noir) selon la quantité de mémoire utilisée. Une icône blanche indique une mémoire vide et une icône noire indique une mémoire pleine.
	Erreur SDC : Si ce symbole persiste pendant plus de 5 secondes, une carte SD est présent mais ne fonctionne pas correctement.
	Réseau sans-fil : Indique qu'un coordonnateur de réseau sans-fil (module de communication sans-fil) est présent et en communication avec la centrale.
	Réseau sans-fil : Indique qu'un coordonnateur de réseau sans-fil (module de communication sans-fil) est présent, mais que la communication avec la centrale est en faute.

Puisque les fonctions de programmation de la centrale sont protégées par mot de passe, il est nécessaire d'accéder à l'écran de mot de passe :

- Appuyer sur Enter pour afficher l'écran « Mot de passe »
- Utiliser les flèches haut ou bas pour augmenter ou diminuer la valeur du premier chiffre
- Utiliser la flèche de droite pour passer au prochain chiffre
- Lorsque tous les chiffres sont exactes, appuyer sur Enter pour
- valider le mot de passe et accéder aux fonctions de programmation.

Mot de passe - - - -

Le premier écran d'options de MENU s'affiche. Utilisez les touches fléchées pour naviguer dans les nombreux écrans jusqu'à la fonction désirée et appuyez sur Enter (Valider) pour y accéder.

← MENU →
1. Info Tx → 3. Evene
2. Groupes 4. Acqui

← MENU →
→ 5. Copie 7. Reseau
6. Config 8. Tests

← MENU
→ 9. BACNet
10. Reseau sans-fil

1. Menu Info Tx

INFO Tx est l'option de menu dédiée aux informations de transmetteurs et contient plusieurs autres options qui peuvent varier selon l'adresse (ou le type) d'appareil. Certains appareils afficheront les options Tx INFO suivantes :

- Ident : Permet de consulter ou modifier l'information d'identification de la composante de réseau.
- COM : Permet de consulter ou de modifier le protocole de communication
- Détection ou Échelle (1) et Échelle (2) : Permet de visionner ou de modifier la plage de detection et l'unité de mesure
- Affichage : Permet de consulter ou de modifier l'identification (nom) d'une composante
- Alarmes : Seuils d'alerte permettra d'être visionnées et parfois changé. Il ne peut y avoir des variations importantes dans cet écran en fonction de l'émetteur de type.
- Codes d'Etat : Indique les codes d'états aux fins de dépannage (dans les valeurs hexadécimales)
- Effacer ou en cours Tx : Efface ou modifie l'adresse Tx

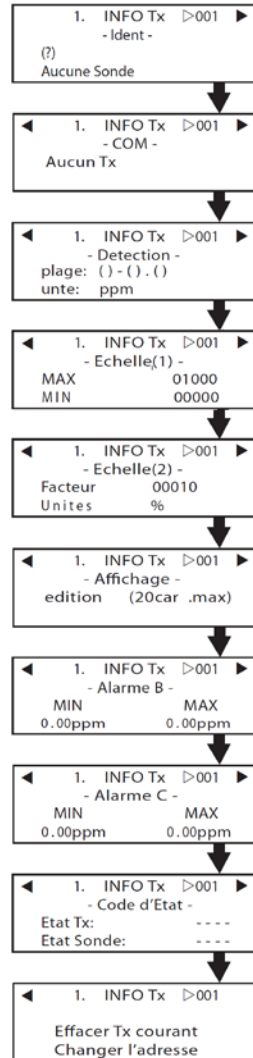

Menu Ident

Le menu Ident, ou identification, permet de consulter ou de modifier l'identification de réseau de la composante sélectionnée :

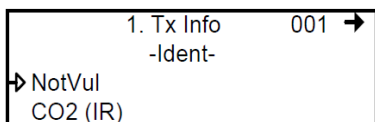

La partie supérieure droit de l'écran affiche l'adresse de réseau de la composante. Sélectionner le champs pour inscrire l'adresse à consulter (si elle est connue) :

- Utiliser les flèches pour déplacer le curseur à la gauche de l'adresse
- Appuyer sur Enter (l'adresse est en mode édition lorsqu'elle clignote)
- Utiliser les flèches haut et bas pour augmenter ou diminuer la valeur
- Appuyer sur Enter pour valider l'adresse et afficher les informations de cette composante.

La partie inférieure de gauche affiche le nom du transmetteur (ex. : 301D2 - nom du produit) et le type de sonde (ex. : CH4 - méthane). Ces valeurs peuvent également être modifiées pour le type de produit Vulbus ou groupe :

Programmer ou modifier le type de produit ou de sonde

- Utiliser les flèches pour déplacer le curseur à la gauche du champ de produit ou de sonde.
- Appuyer sur Enter pour sélectionner le champ (en mode édition lorsque le champs clignote)
- Utiliser les flèches pour dérouler la liste de types de produit ou de sondes et appuyer sur Enter lorsque le produit ou la sonde approprié est affiché.

Type de produit et types de sondes

Voici une liste de tous les types de produits (préprogrammés) disponibles dans l'option d'identification du menu de renseignements sur l'émetteur.

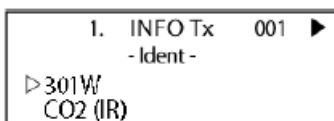

Produits compatibles :

- E3Point
- 420MDBS
- ECFX
- 301R
- 301EM
- SQN8x
- XCD
- XNX
- IAQPoint2
- Anciens produits Vulcain

Note: Lorsque le type de produit est un groupe, les autres écrans INFO TX ne seront pas disponibles (puisque chaque produit a déjà été configuré dans la centrale). Seul les écrans Ident, Affichage et Effacer Tx courant seront disponibles.

La liste de type de sonde s'applique aux adresses 1 à 96 et ne dépend pas de la sélection de type de produit. Les dispositifs dans la plage d'adresses de 97 à 170 affichent un identificateur BACNet.

* Un type de produit supplémentaire, intitulé « Groupe », représente les groupes créés dans le menu Groupe de la centrale. Lors du déroulement dans la liste de types de produits disponible, ce type apparaîtra pour chaque groupe créé (Groupe 1, Groupe 2, Groupe 3, etc.). Si le type de produit sélectionné est un groupe, les types de sondes disponibles seront uniquement MIN, MAX et MOY.

Com

Cet écran affiche le protocole de communication de la composante sélectionnée pour les adresses de 1 à 96. Le protocole de chaque transmetteur est défini par la centrale (voir la section Auto-configuration du réseau).

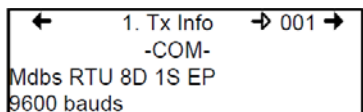

Si un transmetteur est compatible avec plusieurs protocoles, il est possible de sélectionner un autre protocole parmi les options suivantes :

- Vulbus
- MdbS ASCII 7D 2S NP 9 600 bauds
- MdbS RTU 8D 2S NP 9 600 bauds
- MdbS RTU 8D 1S NP 9 600 bauds
- MdbS RTU 8D 1S OP 9 600 bauds

Lorsqu'un transmetteur est configuré avec le protocole de communication Modbus, le transmetteur envoie automatiquement les paramètres de programmation à la centrale.

Note: Les paramètres de transmetteurs Vulbus doivent être configurés manuellement.

Echelle (1 et 2)

Ces menus apparaissent uniquement pour certains dispositifs. Echelle (1) permet de modifier la plage de détection, minimum et maximum, pour l'appareil sélectionné. Quelle que soit la valeur spécifiée, elle apparaîtra sur l'écran de l'appareil (le cas échéant). La valeur minimale est généralement laissée sur 0. Vous pouvez consulter les paramètres des détecteurs de gaz XNX et XCD ici, mais ils ne sont modifiables que sur l'émetteur.

←	1.	INFO Tx→	121	→
		-Echelle(1)-		
	Max	00250		
	Min	00000		

Echelle (2) permet de configurer le facteur de division de la plage (entre 0 et 65535) et de modifier l'unité de mesure pour la plage sélectionnée.

←	1.	INFO Tx	121	→
		-Echelle(2)-		
	→	Facteur	00001	
		Unites	ppm	

Le facteur permet des limites de plages plus précises pour la détection. En divisant la valeur de plage maximum dans le premier écran Echelle (250 dans cet exemple) par 10, il est possible de détecter une valeur de plage de 25.0.

Les « Unités » permettent de régler l'unité de mesure de chaque appareil :

- °F : Règle l'unité de mesure en degrés Fahrenheit
- °C : Règle l'unité de mesure en degrés Celcius
- %HR : Règle l'unité de mesure au pourcentage d'humidité relative
- mV : Règle l'unité de mesure du point en millivolts
- V : Règle l'unité de mesure du point en volts
- mA : Règle l'unité de mesure du point en milliamps
- % : Règle l'unité de mesure du point au pourcentage du gaz
- ppm : Règle l'unité de mesure du point en parties par million du gaz

Détection

Le menu Détection (disponible uniquement pour les adresses de 1 à 96) affiche la plage de détection (plage: 0 à 0.00) ainsi que l'unité de mesure (unité : %) pour le transmetteur sélectionné. La plage de détection est entre 0 et la valeur maximale (0.00) et l'unité de mesure est soit ppm ou pourcent (%). Si le transmetteur utilise le protocole Modbus, les paramètres de détection sont définis de façon automatique lors de la configuration du réseau et ne peuvent être modifiés. Les protocoles Vulbus doivent être définis par un programmeur.

Le menu de détection n'est pas disponible pour les appareils 301R ou 301AP.

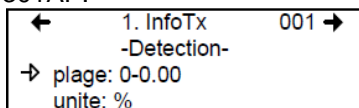

Programmer ou modifier la plage ou l'unité de détection l'unité :

- Utiliser les flèches pour déplacer le curseur à l'option plage ou unité
- Appuyer sur Enter et utiliser les flèches haut et bas pour augmenter ou diminuer la valeur
- Appuyer sur Enter pour valider la valeur désirée

Affichage

Cette option permet de donner une étiquette ou un nom à la composante sélectionnée (transmetteur, relais et annonceurs). L'étiquette peut contenir jusqu'à 20 caractères, incluant les espaces (ex. : CHAMBRE GICLEURS). Les étiquettes de transmetteurs Modbus sont assignés par défaut et sont composés du nom de la composante, le type de sonde et l'adresse.

Les étiquettes de transmetteur Vulbus contiennent 20 espaces blancs.

←	1. INFO Tx	→ 001	→
	-Affichage-		
edition		(20 car.max)	
301D2	CH4	Ad001	

Alarme A, B et C

Puisque les écrans d'affichage sont identiques pour chacun des alarmes, ils ont été regroupés aux fins de ce manuel. Cependant, chaque alarme doit être configuré séparément selon vos besoins.

Cette option permet de configurer des niveaux d'alarme minimum et maximum pour les alarmes A, B et C. Ceci crée une plage de tolérance où aucune action n'est effectuée. Toutefois, si les concentrations de gaz dépassent le niveau maximum, un alarme est activé. L'alarme ne sera pas désactivé avant que la concentration de gaz revienne en dessous du niveau minimum précisé.

Avec certains transmetteurs, un seul seuil d'alarme est affiché.

En outre, avec certains transmetteurs, les seuils d'alarmes sont en lecture seulement sur le contrôleur. Ces seuils peuvent être réglés uniquement au transmetteur.

Ceux-ci sont des écrans typiques:

```
◀ 1. INFO Tx ▷026 ▶  
-Alarme B-  
Level  
60.0 %LEL
```

Typiques de screen pour la visualisation des alarmes A ou B de XCD et XNX transmetteurs.

```
◀ 1. INFO Tx ▷001 ▶  
-Alarme A-  
MIN MAX  
0.00% 0.00%
```

Typiques de screen pour la visualisation ou changer des alarmes A, B, ou les seuils C seuils sur d'autres transmetteurs.

Entretien et Exploitation des Menus

Ces fonctions varient selon le type d'émetteur. Ces écrans montrent le temps total du dispositif a été mis en service et le temps restant jusqu'à la prochaine calibration nécessaires ou de remplacement

← 1. INFO Tx → 001 →
-Entretien-
4002h en fonction
15514h avant entr.

← 1. INFO Tx → 121 →
-Temps d'Operation-
Temps de Vie: 00000
Depuis calib: 00730

← 1. INFO Tx ▷026 ▶
- Temps d'opération -
Sensor life left:
1804 days

Code d'Etat

Cet écran affiche l'état de la transmission (Tx) ou du noeud (seulement pour les appareils sans-fil) et l'état de la sonde pour l'adresse du dispositif sélectionné, en valeurs hexadécimales. Cet écran est aux fins d'informations seulement; les données affichées ne peuvent pas être modifiées.

Les détecteurs de gaz XNX et XCD indiqueront le numéro d'avertissement ou d'anomalie (iFaultWarnNumber) au format hexadécimal sur la troisième ligne. Ces émetteurs signaleront également l'état de surveillance (iMonitoringState) sur la quatrième ligne. Consultez la documentation de l'émetteur pour interpréter les numéros d'anomalie et les états de surveillance.

```
◀ 1. INFO Tx ▷026 ▶
  -Code d'Etat-
Etat Tx:      0000
Etat Monitor: 0001
```

Affichage type de XNX ou XCD

```
← 1. INFO Tx → 121 →
  -Code d'Etat-
Etat Tx:      12FAh
Etat Sonde:   4407h
```

Affichage type des autres émetteurs

Effacer Tx courant

Cette fonction permet de supprimer la configuration (InfoTx seulement) de la composante sélectionnée.

```
← 1. INFO Tx → 001 →
  Effacer Tx courant
  Changer l'adresse
```

Note: Cette fonction efface seulement les données InfoTx. Aucune autre information n'est effacée.

Modification de l'adresse de l'émetteur

L'option Changer l'adresse permet de modifier l'adresse d'un dispositif :

L'option Changer l'adresse est seulement disponible pour les adresses de 1 à 96 et s'il y a un appareil Modbus connecté.

Si l'adresse est valide, l'écran affichera « En cours... ».

Si l'adresse est invalide, l'écran affichera « Tx invalide » et reviendra à l'écran Changer l'adresse (il n'est pas possible de changer l'adresse de dispositifs GasPoint).

Un dernier écran affichera soit « Succes » ou « Erreur » (en cas d'erreur, recommencer le processus).

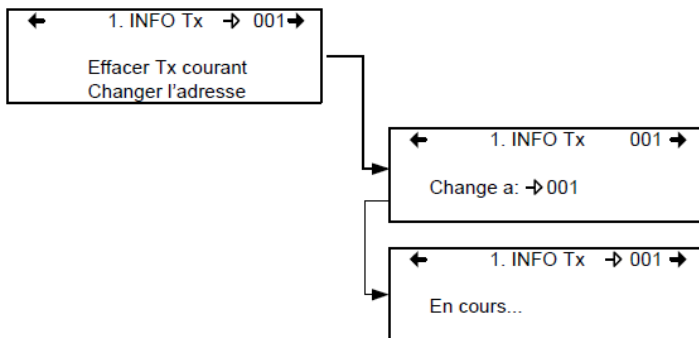

Note: Si une adresse est changée pour une adresse déjà associée à un autre dispositif, les données existantes seront perdues. Les clients doivent connaître les adresses attribuées sur leurs réseaux et porter une attention spéciale lors du changement d'adresse. Ne pas oublier de supprimer l'adresse d'origine pour éviter toutes duplications de données. Cette fonction n'est pas prise en charge par les émetteurs XNX et XCD.

2. Menu groupes

La programmation de groupes de transmetteurs permet de regrouper des unités, ce qui permet d'agir (événements) en réponse à un groupe d'unités plutôt que sur chaque unité, individuellement.

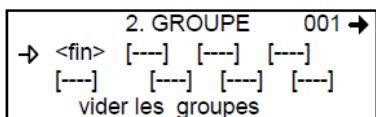
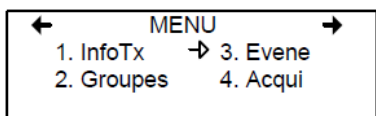

Un groupe est un bloc contenant les adresses de chaque transmetteurs du groupe.

Les groupes sont affichés sur une seule ligne; si le groupe contient plus de quatre composantes, il faudra utiliser les flèches gauche et droite pour visionner la liste de tous les transmetteurs du groupe (puisque un écran peut contenir seulement 20 caractères).

Le curseur de l'écran Groupe est représenté par les parenthèses clignotantes (<fin>). Les informations entre les parenthèses peuvent être modifiées.

Créer des groupes

- Utiliser les flèches pour déplacer le curseur à la gauche du numéro de groupe
- Appuyer sur Enter puis changer le numéro
- Appuyer sur Enter pour valider (créer)
- Utiliser les flèches pour placer le curseur sur une ligne de groupe et appuyer sur Enter
- Le champ est en mode édition lorsque le <fin> clignote
- Utiliser les flèches haut et bas pour dérouler dans la liste d'unités connectées à la centrale jusqu'à l'obtention de l'adresse appropriée.
- Appuyer sur Enter pour valider l'adresse.
- L'adresse est ajoutée au groupe et le curseur est déplacé vers la droite.

Répéter le processus pour ajouter tous les transmetteurs désirés (jusqu'à 126 par groupe). L'adresse de chaque transmetteur configuré dans le menu InfoTx est disponible pour créer des groupes.

Note: Les groupes créés dans ce menu apparaîtront dans la liste de types de produits (menu INFO Tx, option Ident) et seront identifiés « Groupe xx » (xx est le numéro assigné au groupe lors de la création).

Supprimer des groupes

La commande *vider les groupes* permet de supprimer tous les groupes configurés dans la centrale.

Pour supprimer des groupes individuellement :

- Afficher le premier transmetteur du groupe
- Sélectionner le transmetteur (l'adresse clignote) et utiliser les flèches pour dérouler les options et sélectionner (l'option supprime l'entrée et l'option <fin> indique la fin du bloc.
- Appuyer sur Enter et le groupe est vidé.

Cette procédure permet de supprimer un, plusieurs ou tous les transmetteurs du groupe.

Note: *Vous pouvez créer jusqu'à 126 groupes, avec un maximum de 128 membres chacun.*

3. Menu événement

Quoique la centrale est expédiée avec des configurations d'événement par défaut (exemple ci-dessous), le menu Événement offre la flexibilité de modifier les paramètres. La programmation d'événement permet de définir des actions précises :

Action :

Quelle action sera activée si les critères configurés sont atteints

```

3. EVENEMENT → 001
  -Action-
Cible:→ Ctrl
Relais: #01
    
```

Délais :

Définition du délais à attendre avant de démarrer une action et à attendre après qu'un événement soit revenu à normal avant de remettre la sortie en état normal

```

← 3. EVENEMENT → 001
  -Délais-
Avant: → 99min
Après:  01min
    
```

Conditions :

ET, OU ou --- (aucun); sont les operands permettant un contrôle précis d'un événement

```

← 3. EVENEMENT → 001
  ( 1/3 Gr036 Q ) ET
  = 2.01%
    
```

Période couverture :

Définit la période durant laquelle l'événement est valide (actif)

```

← 3. EVENEMENT → 001
  -Periode couverte-
→ Toute la journee
  Toute la semaine
    
```

Statut : activé :

Active ou désactive un événement

```

← 3. EVENEMENT → 001
  -Statut : desactive-
→ Active evenement
  .
    
```

Base de donnée :

Permet d'effacer l'événement sélectionné ou d'effacer tous les événements.

```

← 3. EVENEMENT → 001
  -Base de donnee-
→ Effacer evenement
  Eff. Tous les even.
    
```

Les valeurs par défaut du système pour les actions à effectuer :

- Relais No. 1 sera activé lorsque le niveau d'alarme A est atteint sur n'importe quel transmetteur connecté au réseau
- Relais No. 2 sera activé lorsque le niveau d'alarme B est atteint sur n'importe quel transmetteur connecté au réseau
- Relais No. 3 sera activé lorsque le niveau d'alarme C est atteint sur n'importe quel transmetteur connecté au réseau
- Appuyer sur la touche Silence pour reconnaître les événements et arrêter l'alarme sonore.
- Relais No. 4 sera activé lorsque n'importe quel transmetteur connecté au réseau est en faute.

Action

Les actions comprennent deux paramètres :

3. EVENEMENT → 001
-Action-
Cible: → Ctrl
Relais: #01

- Cible Indique le composant responsable de l'action à exécuter;
Tx (transmetteur)
Re (relais/indicateur)
Ctrl (centrale)
- Relais Indique quelle des trois sorties activé lorsque l'événement est vrai :
#XX (active le relais #xx de la composante), Alarme sonore (active l'alarme sonore de la composante)
ALL (active tous les relais et les alarmes sonores)

Exemple : L'émetteur 007 détecte une concentration dépassant les valeurs réglées. La cible (contrôleur) déclenche le relais 1 raccordé à cet événement (un ventilateur, par exemple). Plusieurs événements peuvent être associés à un seul relais. Le cas échéant, le relais s'activera si tous les événements associés sont vrais.

Délais

Cette option permet de configurer les paramètres Avant et Après qui retardent l'activation ou la désactivation d'une action.

Avant Retarde une action pour la durée de temps précisée. Si la condition persiste après le délai précisé, un alarme est activé et l'action précisée est effectuée.

Après Retarde la désactivation d'une action; l'action continuera jusqu'à l'épuisement du temps de délais précisé et si l'événement n'est plus vrai. Il est également possible de sélectionner l'option "latch" dans le champs de délais après.

←	3. EVENEMENT	→ 001
	-Dela-	
	Avant: →	99min
	Apres:	01min

Les délais Avant et Après peuvent être programmés à soit 30 ou 45 secondes ou de 1 à 99 minutes, en incrément de 1 minute. L'option à cinq traits d'union indique qu'il n'y a aucun délai configuré.

- Utiliser les flèches pour déplacer le curseur à l'option désirée
- Appuyer sur Enter pour sélectionner l'option
- Utiliser les flèches pour dérouler dans la liste de secondes ou minutes
- Appuyer sur Enter pour valider le délais désiré.

Délais mode latch

La fonction *Latch*, disponible depuis le menu déroulant du délais Après, est exécuté sur un état d'événement. Essentiellement, c'est un circuit de verrouillage, c'est à dire qu'une intervention humaine est nécessaire pour déverrouiller l'action de l'événement.

L'événement demeure actif jusqu'au moment de pression sur la touche Silence. Cette touche arrête l'alarme sonore et relâche l'événement. Lors de l'appui sur la touche Silence, les événements sont relâchés et réévalués. Si la condition de l'événement est toujours vrai, l'événement demeure actif et revient en mode Latch. Si la condition ne persiste pas, l'événement est désactivé.

Note: Si un événement est configuré avec un délais Avant et que la touche Silence est enfoncée lorsque les conditions de l'événement sont toujours vraies, l'alarme sonore sera fermé
Note: seulement pour la durée du délais précisé.

Conditions

Les Conditions sont les paramètres de définition (de calculs) qui décident si un événement est vrai ou non. Chaque condition est définie par quatre éléments. Il est également possible de lier deux conditions pour obtenir une plus grande flexibilité. Une condition défini :

Si au moins 1/3 du groupe 36 détecte des concentrations supérieures à 2.01% du gaz précisé ET tout les éléments du groupe 03 détectent une concentration supérieure à 2.99% de gaz, l'action précisée (configurée dans le premier écran événement) pour cette événement sera déclencher.

Puisque l'affichage offre une espace limitée, il est nécessaire de naviguer à gauche et à droite pour configurer ou consulter tous les paramètres de condition.

Écrans de programmation de conditions

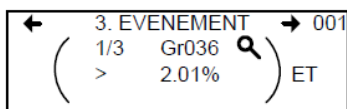

```
← 3. EVENEMENT → 001
( 1/3 Gr036 ) ET
  > 2.01%
```

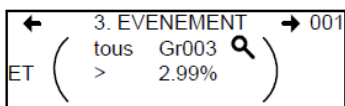

```
← 3. EVENEMENT → 001
ET ( tous Gr003 )
    > 2.99%
```

La partie de l'écran de condition événement entre parenthèses est divisée en quatre champs éditables :

La partie supérieur de gauche contient le quantificateur de statistique (disponible seulement pour les groupes). Cette option permet de choisir quelle partie du groupe à inclure dans l'équation. Les options de ce champs sont :

- tous : comprend tous les émetteurs du groupe
- moy : comprend la concentration moyenne des émetteurs du groupe
- max : comprend la concentration maximale du groupe
- min : comprend la concentration minimale du groupe
- 1/4 : comprend au moins un quart des émetteurs du groupe conforme aux conditions définies
- 1/3 : comprend au moins un tiers des émetteurs du groupe conforme aux conditions définies
- 1/2 : comprend au moins la moitié des émetteurs du groupe conforme aux conditions définies
- 2/3 : comprend au moins deux tiers des émetteurs du groupe conforme aux conditions définies
- 3/4 : comprend au moins trois quarts des émetteurs du groupe conforme aux conditions définies
- 1 ou + : au moins un ou plusieurs émetteurs du groupe conforme aux conditions définies

La partie inférieure à gauche de l'écran contient le quantificateur de logique, ou l'opérateur, qui détermine comment les conditions sont calculées. Les options disponibles dans ce champs sont :

Symbole opérateur	Signification
--	Aucun opérateur
=	Égal à
<=	Égal à ou inférieur à
<	Plus petit que
>=	Égal à ou supérieur à
>	Plus grand que
!=	Pas égal
max	Lorsque la valeur maximum est atteinte, une action est déclenchée. L'action ne sera pas désactiver sans que les niveaux baissent en dessous de la valeur minimum
min	L Lorsque que les concentrations descendent plus bas que la valeur minimum, une action est déclenchée. L'action ne sera pas désactivé sans que les niveaux remontent au dessus de la valeur maximum précisée

La partie supérieure droite de l'écran contient la source, ce qui défini sur quel unité ou groupe d'unités l'événement sera basé. Les options disponibles dans ce champs sont :

- GrTous : Inclus tous les transmetteurs (voir note)
- Gr000 : Inclus seulement les unités dans le groupe précisé (voir note)
- Tx000 : Inclus seulement le transmetteur précisé (connecte à la centrale)
- Heure : Inclus seulement les informations recueillies dans la plage horaire précisée. La sélection de l'horloge configure une condition applicable seulement entre l'heure de début et l'heure de fin. Il est possible de configurer un écran de condition avec des paramètres particuliers et l'autre écran de condition avec une plage horaire : la

condition précisée déclenchera un événement seulement si elle se produit dans la plage précisée.

Note: Cliquer sur la loupe à droite d'un groupe pour accéder à l'écran du groupe (consultation ou modification). Appuyer sur ESC pour fermer l'écran et revenir à l'écran de condition.

La partie supérieure droite de l'écran contient la source, ce qui définit sur quel unité ou groupe d'unités l'événement sera basé. Les options disponibles dans ce champ sont :

- OFF : Utilisé pour le statut des entrées binaires (ex. : utilisé avec le 301ADI)
- ON : Utilisé pour le statut des entrées binaires (ex. : utilisé avec le 301ADI)
- Faute : Base le déclenchement sur un alarme d'entretien, de communication ou de faute d'unité
- Alrm A: Si le dispositif ou le groupe choisi éprouve une Alarme A ou Alarme 1, un événement sera déclenché.
- Alrm B: Si le dispositif ou le groupe choisi éprouve une Alarme B ou Alarme 2, un événement sera déclenché.
- Alrm C: Si le dispositif ou le groupe choisi éprouve une Alarme C, un événement sera déclenché.

L'écran Période couverte permet de définir la période couverte par l'événement. Ce champ offre deux options supplémentaires :

Champ de définition de jour : permet de sélectionner soit Toute la journée, Jour ou Nuit

Champ de définition de semaine : permet de sélectionner soit Toute la semaine, Jours ouvrables ou Fin de semaine

←	3. EVENEMENT	→ 001
	-Periode couverte-	
→	Toute la journee	
	Toute la semaine	

1. Utiliser les touches de flèches haut ou bas pour naviguer soit à Toute la journee ou à Toute la semaine.
2. Appuyer sur Enter pour sélectionner

3. Utiliser les touches de flèches haut ou bas pour dérouler les options
4. Appuyer Enter pour sélectionner l'option affichée.

Statut

Cet écran affiche l'état actuel des événements et permet de les activer ou de les désactiver, selon l'état actuel.

Active événement : Appuyer sur Enter pour sélectionner Active événement ou Désactive événement

←	3. EVENEMENT	→ 001
	-Statut : desactive-	
→	Active evenement	

Lorsque tous les détails d'un événement sont inscrits, le dernier écran de configuration affiche « Active événement ». Appuyer sur Enter pour valider les paramètres et activer l'événement.

Lors de consultation d'un événement existant, la première ligne de cet écran afficherait « Désactive événement ». Appuyer sur Enter sur cette ligne permet de basculer entre l'activation et la désactivation. L'appui sur la touche Enter (pour désactiver) ferme simplement l'événement et ne supprime pas l'événement. L'événement sera toujours disponible pour réactivation.

4. Menu Acquisition

Le mode Acquisition est seulement disponible lorsque la centrale est munie d'une carte SD (option d'enregistrement de données). Cette fonction permet d'activer ou de désactiver l'enregistrement des événements du système ou les informations des transmetteurs. L'information est enregistrée sur une carte de mémoire « SD ». L'utilisateur doit configurer les intervalles et les conditions d'enregistrement nécessaires à cette fonction.

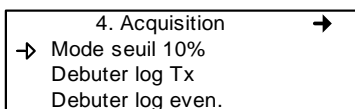

La première ligne de l'écran Acquisition permet de sélectionner soit :

- Mode delai : Permet de préciser des intervalles d'enregistrement de 10 à 59 secondes ou de 1 à 60 minutes.
- Mode seuil : Permet de configurer l'enregistrement selon les seuil de variation depuis la dernière lecture, soit de 3% ou plus, 5% ou plus ou de 10% ou plus de la dernière concentration détectée.

La sélection du seuil 3% ne signifie pas qu'une variation de 3% sera détectée mais qu'une variation 3.1% le sera. La fréquence de saisie (fréquence de rafraîchissement) peut affecter l'enregistrement de données.

Voici un exemple de l'enregistrement en mode seuil. Ces fichiers sont des fichiers textes séparés par des points-virgules :

```
2005-04-27 11:05:20;1_CO2_ppm;574;-normal-:
2005-04-27 11:06:02;1_CO2_ppm;503;-normal-:
2005-04-27 11:06:15;1_CO2_ppm;562;-normal-:
2005-04-27 11:06:28;1_CO2_ppm;645;-normal-:
2005-04-27 11:06:39;1_CO2_ppm;557;-normal-:
2005-04-27 11:30:45;1_CO2_ppm;715;-normal-:
```

Debiter et arreter log Tx

L'étape précédente traitait la fréquence d'enregistrement de données. Maintenant, il faut débiter le processus :

Lorsque « Debiter log Tx » est affiché, le mode acquisition (enregistrement) est inactif. Lorsque « Arrêter log Tx » est affiché, les données sont en cours d'enregistrement. Un message d'enregistrement est affiché à l'écran et le DEL de la carte SD s'allume.

Appuyer sur Enter pour Débuter ou Arrêter l'enregistrement.

Lorsque les données Tx sont enregistrées, le système crée des fichiers **taaammjj.log**, **tbaammjj.log** et **tcaammjj.log**. Ces fichiers contiennent, respectivement, le tiers des données des transmetteurs. Le registre comprend la date et l'heure, l'adresse du transmetteur, le type de sonde, la concentration à la lecture ainsi que le statut de l'alarme:

```
2004-01-23 17:54:25; 001_CO_ppm;0;-normal-002_NO2_ppm;1.5;-normal-003_CO_ppm;0;-normal-
2004-01-23 17:55:25; 001_CO_ppm;0;-normal-002_NO2_ppm;0.5;-normal-003_CO_ppm;0;-normal-
2004-01-23 17:56:25; 001_CO_ppm;0;-normal-002_NO2_ppm;0.5;-normal-003_CO_ppm;0;-normal-
2004-01-23 17:57:25; 001_CO_ppm;0;-normal-002_NO2_ppm;1.0;-normal-003_CO_ppm;0;-normal-
2004-01-23 17:58:25; 001_CO_ppm;0;-normal-002_NO2_ppm;1.5;-normal-003_CO_ppm;0;-normal-
```

Ces fichiers journaux sont délimités par des points-virgules et sont donc facilement lus par les tableurs populaires tel que Microsoft Excel. La première colonne affiche la date (aaaa-mm-jj) et l'heure (hh:mm:ss) de l'enregistrement. Cet exemple indique un délai configuré à un intervalle d'une minute.

La troisième colonne affiche l'adresse du transmetteur et le type de sonde et la quatrième colonne indique la concentration et l'unité de mesure.

Les colonnes se répètent pour chaque transmetteur, séparées par des traits d'union. La liste continue ainsi jusqu'au dernier transmetteur dans la liste.

Débuter et arrêter log événement

Le menu Acquisition offre l'option d'enregistrement d'événements. L'enregistrement d'événements enregistre les transactions de la centrale, les événements, les avertisseurs de Tx et d'alarmes et le statut de relais.

Lorsque « Debuter log even. » est affiché, le mode acquisition (enregistrement) est inactif. Lorsque « Arrêter log even. » est affiché, les données sont en cours d'enregistrement.

Appuyer sur Enter pour débuter ou arrêter l'enregistrement.

Lorsque les données d'événements sont enregistrées, le système crée un fichier **evaammjj.log**. Ce registre indique la date, l'heure et l'événement. Voici un exemple d'un registre d'événement :

```
2006-01-23 17:54:25; Log evenement active
2006-01-23 17:55:25; Arrêt système
2006-01-23 19:05:47; Sequence de simulation active
2006-01-23 19:05:48; Tx 6 communication n'est plus en faute
2006-01-23 19:05:48; Tx 8 communication n'est plus en faute
```

La première colonne du registre indique la date (aaaa-mm-jj) et l'heure (hh:mm:ss) de l'enregistrement. L'exemple ci-haut démontre des intervalles de délais d'une minute.

Le système enregistre ces types d'événements :

- Journal événements
- Changement de statut d'événement
- Changement de statut pour alarmes A, B, C, faute

Note: De nouveaux fichiers « log » seront créés lorsque le fichier actuel atteint 32,000 lignes ou le dimanche à 0h.

5. Menu de copie

L'option Copie du menu Info TX permet de copier ou de transférer les paramètres programmés. Il est possible de transférer des données d'une carte SD de la centrale à un ordinateur et vice versa ou de copier des paramètres d'un transmetteur à un autre. L'option Copie offre trois écrans : Configuration, Paramètres et Journal Sys.

Configuration

Si la centrale est munie d'une carte mémoire, la fonction Configuration permet de transférer les données soit du 301C à la carte SD ou vice versa. Ceci permet de transférer la programmation de la centrale sur un ordinateur ou d'un ordinateur à la centrale.

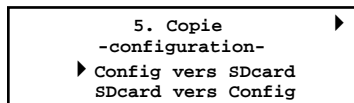

La première option de l'écran, 301C vers SDcard, copie la configuration et les paramètres de la centrale dans un fichier « config.ini ». La deuxième option, SDcard vers 301C, permet de copier la configuration et les paramètres du fichier « config.ini » à la carte SD de la centrale. ¹

Note: La deuxième option, Carte SD vers 301C, permet de copier la configuration et les paramètres du fichier « config.ini » d'une carte SD vers le contrôleur. L'alimentation doit être désactivée/activée pour implémenter complètement la configuration de la carte SD en conservant le cavalier sur la broche SHDN (voir l'illustration, page 119). Le contenu du fichier « config.ini » est modifiable à tout moment et depuis n'importe quel ordinateur.

1. Lors de transfert de données, le système cherche automatiquement un fichier existant nommé « config.ini » avant de procéder. Si un tel fichier existe, le système cherche le fichier « config.bak ». Si le fichier est trouvé, il est supprimé. Le fichier « config.ini » existant est renommé « config.bak ». Il est maintenant possible d'enregistrer le nouveau fichier « config.ini », tout en conservant une copie du fichier précédent. Lors de l'insertion d'une carte mémoire dans la centrale, le système de la centrale cherche automatiquement un fichier « config.ini » existant contenant le label « Autoload » égal à 1. Si le label est trouvé, le système télécharge le contenu du fichier et réinitialise le « Autoload » à 0. Cette fonction est utile pour éditer la configuration sur un ordinateur sans affecter la centrale (tels les événements enregistrés).

Paramètres

La fonction paramètres permet de copier la configuration d'un transmetteur à un autre ou de copier les paramètres d'un événement à un autre. Ceci permet une configuration plus rapide pour les unités partageant des paramètres identiques ou similaires

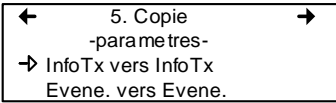

Les options de cette écran sont :

InfoTx vers InfoTx copie les paramètres de transmetteur d'un unité à l'autre.

Evene. vers Evene. copie les paramètres d'un événement à l'autre.

Le processus est identique pour chaque option :

- Utiliser les flèches pour sélectionner la source, (les données à copier) et appuyer sur Enter.
- Lorsque l'adresse du transmetteur clignote, utiliser les flèches haut et bas pour naviguer et sélectionner l'adresse désirée.
- Appuyer sur Enter pour valider l'adresse
- Sélectionner l'adresse cible (où copier les données) de meme façon que la sélection de la source
- Sélectionner COPIER et appuyer sur Enter. Les paramètres sont copiés.

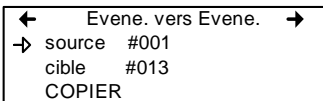
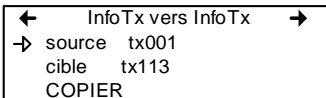

Journal système

La centrale enregistre les données du journal dans sa mémoire interne. Si la centrale est munie d'une carte mémoire, la fonction Journal Sys permet d'enregistrer les informations de journal du système en format texte sur la carte de mémoire flash (SD card).

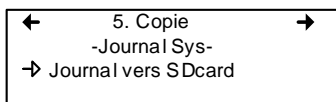

Lorsque sélectionnée, cette option crée un registre de toutes les dernières actions de la centrale sur la carte de mémoire, dans un fichier nommé « slaammjj.log ». Ce fichier peut contenir jusqu'à 64Ko d'information en format texte. Lorsque la carte de mémoire atteint sa capacité, les nouvelles informations remplacent les plus vieilles (qui sont effacées).

Voici un exemple du fichier de journal :

```
--- START of system log dump : 1980-01-22 17:23:51 ---  
1980-01-19 22:07:26;Accessing menu;  
1980-01-19 22:07:41;Chargement config depuis carte SD;  
1980-01-19 22:07:45;Sortie du menu;  
1980-01-19 22:13:05;Accès au menu;  
1980-01-19 22:13:16;Édition paramètres Tx 1;  
1980-01-19 22:18:29;Sortie du menu;  
1980-01-19 23:07:14;Accès au menu;  
1980-01-19 23:07:40;Édition événement 1;  
1980-01-19 23:07:43;Sortie du menu;  
1980-01-19 23:08:10;Accès au menu;  
1980-01-19 23:09:07;Édition événement 2;  
1980-01-19 23:09:13;Sortie du menu;  
1980-01-20 00:06:42;Accès au menu;  
1980-01-20 00:06:52;Sortie du menu;  
1980-01-20 00:07:49;Accès au menu;  
1980-01-20 00:07:55;Sortie du menu;  
1980-01-22 17:23:46;Accès au menu;  
--- END of system log dump : 1980-01-22 17:23:51 ---
```



6. Menu de config

Le menu Config, avec quatres écrans principaux, permet de configurer le mode d'affichage de la centrale, d'ajuster la date et l'heure, de sélectionner le langage d'affichage , de changer le mot de passe d'accès à la centrale, de modifier le port esclave, régler la configuration des relais, sélectionner le mode d'émission AP.

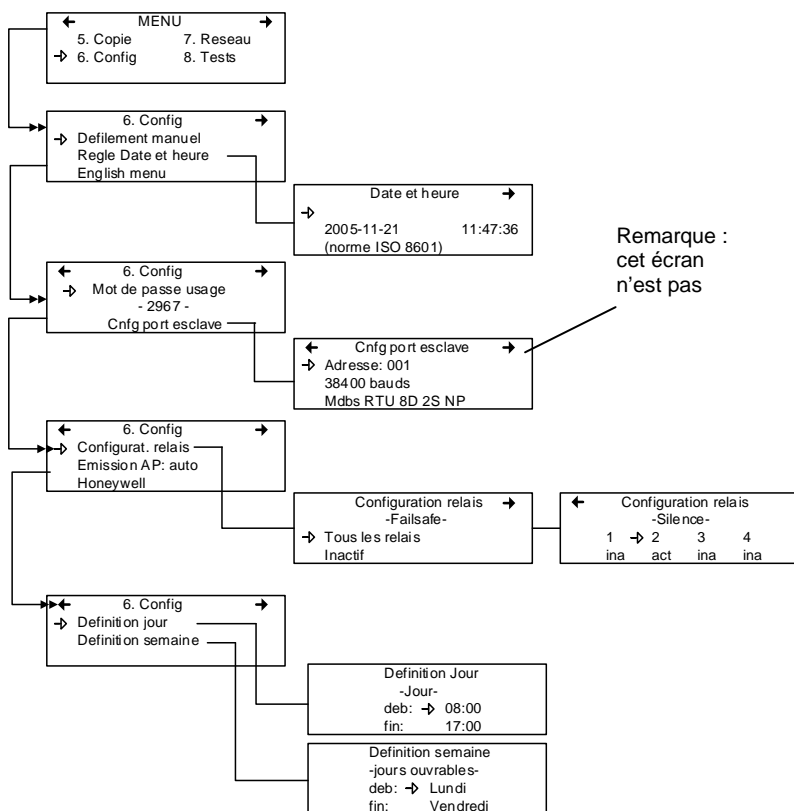
Chaque écran principale offre des options de programmation supplémentaires.

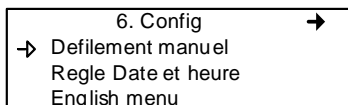

La sélection de la première ligne (du premier écran) offre le choix de trois modes d'affichage : Défilement manuel, Défilement 3 sec, Défilement 5 sec. Ces réglages contrôlent la présence et la fréquence d'affichage des données à l'écran de la centrale. Le mode de défilement manuel signifie que l'utilisateur doit appuyer sur les flèches pour visionner le statut de chaque unité connectée à la centrale. Les mode de défilement 3 secondes et 5 secondes effectuent le déroulement automatique des données, en fréquence de changement d'écran de soit 3 ou 5 secondes.



Note: Il est toujours possible de dérouler dans les écrans d'affichage en appuyant sur les flèches, peut importe le mode sélectionné.

La deuxième ligne permet d'ajuster la date et l'heure depuis un nouvel écran, Date et heure. Lorsqu'un chiffre clignote, il est en mode édition. Utiliser les flèches pour dérouler à la valeur désirée. Il est possible de modifier l'année, le mois, le jour et l'heure, les minutes et les secondes.

La centrale ne gère pas les changement d'heure (telle l'heure avancée). Tout changement d'heure doit être effectué manuellement.

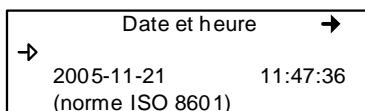

La troisième ligne du premier écran Config permet de changer le langage d'affichage. Si le menu est en anglais, l'écran indiquera Menu français (et vice versa). Déplacer le curseur à la gauche du champ et appuyer sur Enter pour changer le langage.

Le deuxième écran principale de configuration permet de modifier le mot de passe et de modifier la configuration du port esclave.

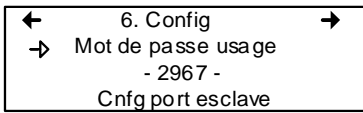

Le mot de passe par défaut est 2967. Sélectionner Mot de passe usager pour modifier le mot de passe :

- Lorsque le premier chiffre clignote, utiliser les flèches pour augmenter ou diminuer la valeur, ensuite
- Utiliser les flèches droite et gauche pour déplacer le curseur une espace et répéter le processus de changement pour chaque chiffre désiré
- Lorsque le mot de passe désiré est afficher, appuyer sur Enter pour le valider et quitter le mode d'édition.

Note: Communiquer avec le soutien technique de Honeywell pour assistance concernant les mots de passe perdus au 1-800-563-2967.

Le port esclave ne est pas utilisée.

Naviguer dans les écrans du menu Config avec les flèches gauche (précédent) et droite (suivant).

Le troisième écran principale permet de régler la configuration des relais, le mode d'émission AP et de choisir parmi quatre fabricants pour la centrale.

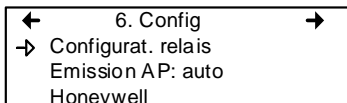

La sélection *Configurat. relais* offre deux options supplémentaires pour la configuration des relais :

La première option, *Failsafe*, permet d'activer (ou désactiver) tous les relais en appuyant sur la touche Enter. Cette fonction est utilisée en cas de panne d'électricité: en cas de panne, le relais déclenche le dispositif connecté (ex. une lampe) pour signaler un problème.

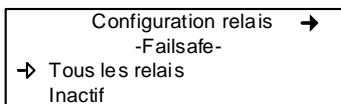

La deuxième option, *Silence*, permet d'activer ou désactiver l'option Silence de chaque relais. Déplacer le curseur à gauche du relais et appuyer sur Enter pour basculer la valeur (act ou ina).

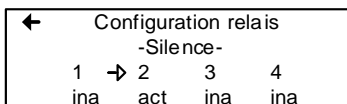

Le quatrième écran de configuration permet de programmer une définition d'un jour et d'une semaine.

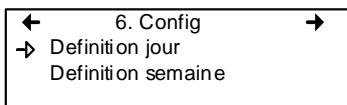

Les définitions de jour ou de semaine permettent de définir les plages d'heures représentées par Jour et les plages de journées représentées par Semaine.

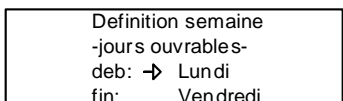
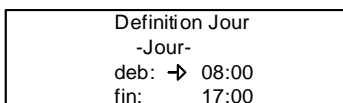

Note: Ne pas oublier que la centrale fonctionne sur une horloge de 24 heures (0:00 à 23:59). La centrale ne gère pas les changements d'heure (telle l'heure avancée). Tout changement d'heure doit être effectué manuellement ou depuis la synchronisation d'heure BACNet (module BACNet nécessaire).

7. Menu de Réseau

Le menu Réseau permet soit de réinitialiser ou de balayer les informations de dispositifs de réseau.

Ce menu offre plusieurs options supplémentaires, en deux écrans. Le premier écran contient trois options :

- RAZ base de donnée : Réinitialise toutes les informations de dispositifs de réseau dans la base de données. Ceci réinitialise seulement les données de dispositif de réseau. Il n'y a aucun impacte sur les groupes ou les événements.
- Balayage réseau : Démarre l'auto-détection de tous les dispositifs de réseau, ce qui permet au système de configurer la base de données de transmission pour les dispositifs de réseau.
- RAZ et balayage : Effectue un balayage et une réinitialisation simultanément.

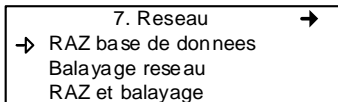

Note: Lorsqu'une de ces options est activée, il faut attendre la fin du processus. Il est impossible d'interrompre le processus.

Le deuxième écran de Réseau présente les options Statistiques et Etalonnage.

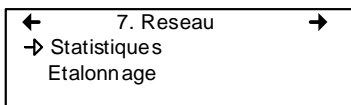

La sélection de statistiques affichent les statistiques pour l'adresse précisée.

Statistiques		
Valide	16	100%
Erreurs	0	0%
Sans rep	0	0%

Valide: Indique le nombre de réponses valides pour les 16 dernières requêtes.

Erreurs: Indique le nombre d'erreur de réponse pour les 16 dernières requêtes.

Sans rep: Indique le nombre d'erreurs de temporisation (pas de réponse) pour les 16 dernières requêtes.

Étalonnage à distance

Le menu Réseau offre également l'option Etalonnage permettant d'effectuer un étalonnage à distance pour les dispositifs qui supportent l'étalonnage en réseau.

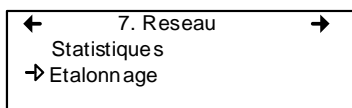

L'écran d'étalonnage contient quatre (4) lignes d'information :

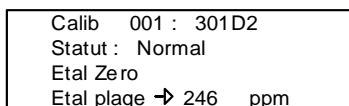

- Ligne 1 : Indique le mode Étalon. qui signifie étalonnage), l'adresse (Modbus) de l'appareil pour étalonner (001) et le type d'appareil à étalonner (301D2)
- Ligne 2 : Indique l'état (normal ou en étalonnage...) de l'appareil spécifié
- Ligne 3 : Affiche la fonction à exécuter (Remettre à zéro)
- Ligne 4 : Affiche la fonction à exécuter (Régler intervalle de mesure) et la valeur de concentration du gaz de réglage (246 ppm)

1. Déplacer le curseur à la gauche de l'adresse de l'unité sur la première ligne et appuyer sur Enter

Etalon→ 001 : 301D2
Statut : Normal
Etal Zero
Etal plage 246 ppm

2. Dérouler la liste pour afficher l'adresse de l'unité désirée* puis appuyer sur Enter pour sélectionner.

3. La deuxième ligne affiche le statut de l'unité

4. Déplacer le curseur à la gauche de la fonction désirée, Etal Zero pour étalonner le zéro de l'unité, et appuyer sur Enter pour sélectionner.

5. Lors de la sélection d'Etal Zero, la centrale demande la confirmation.

Calib 001 : 301D2
Etalonner Zero?
Etal Zero
Etal plage 246 ppm

**L'unité doit être configurée dans la base de donnée du 301C pour figurer dans la liste d'adresses d'unités affichée à l'écran.*

6. Appuyer sur Enter pour confirmer ou Esc pour annuler. Si confirmé, la centrale procède à l'étalonnage du zéro de l'unité. Le processus nécessite seulement quelques instant, puis l'écran affiche de nouveau l'écran d'étalonnage.

Note: Pour effectuer l'étalonnage de l'unité, déplacer le curseur à la gauche de Etal Plage** et changer la valeur d'étalonnage avec la procédure suivante :

7. Pour étalonner l'appareil, sélectionnez Régler intervalle de mesure** et modifiez la valeur d'étalonnage du gaz de réglage en procédant comme suit :

Calib → 001 : 301D2
Statut : Normal
Etal Zero
Etal plage → 246 ppm

- a. Utiliser la flèche droite pour déplacer le curseur à la gauche de xxx ppm (champ de valeur d'étalonnage). Appuyer sur Enter pour sélectionner le champ (la valeur est éditable lorsqu'elle clignote).
- b. Utiliser les flèches haut et bas pour augmenter ou diminuer la valeur. Appuyer sur Enter pour valider.
- c. Déplacer le curseur à la gauche de la fonction Etal Plage et appuyer sur Enter pour démarrer l'étalonnage.

L'étalonnage de la plage démarre. L'écran affiche le statut de l'unité, « En etalon... » jusqu'à la terminaison de l'étalonnage.

***Lors de la sélection d'Etal Plage, assurer que l'unité est exposée au gaz d'étalonnage approprié avant et pendant le processus d'étalonnage.*

8. Menu tests

Le menu Tests permet d'effectuer une gamme de vérifications sur les composants et sur les communications de réseau. Ce menu permet également d'opérer le système dans quatre modes différents, chacun offrant des fonctionnalités particulières.

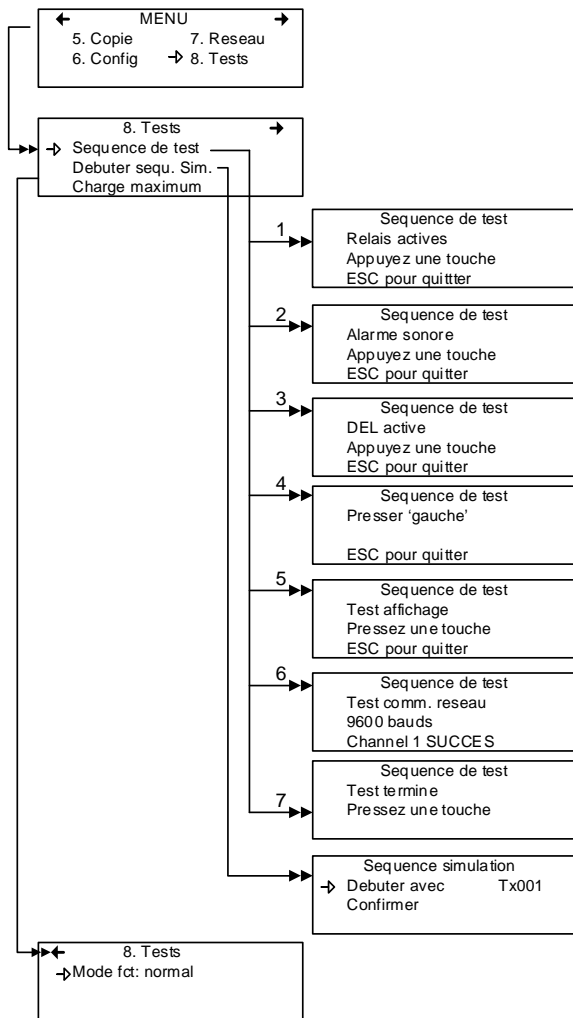

Le menu Tests offre quatre options principales, disponibles sur deux écrans. Chacune de ces options offre des fonctionnalités supplémentaires.

Le premier écran présente trois options :

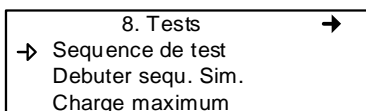

Sequence de test : Permet d'activer chaque sortie et de valider l'opération de chaque touche de clavier, des pixels d'affichage et les divers protocoles de communication de la centrale.

Debuter sequ sim : Démarre ou arrête le mode de simulation, permettant de simuler une concentration de gaz sur la plage associée à chaque transmetteur, l'un après l'autre. Les concentrations simulées sont locales (dans la centrale). (Les événements seront actives pour la simulation, mais les unités de détection ne sont pas affectées.)

Charge maximum : Active toutes les composantes de la centrale

L'option au deuxième écran, « Mode fct », permet de sélectionner le mode de fonctionnement, soit : Normal, Tx unique or debugage.

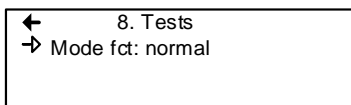

Normal : Mode de fonctionnement normal du contrôleur

Émetteur unique : Active le mode d'observation sur un seul émetteur.

Débugage : Active le mode d'entretien afin d'effectuer un étalonnage et de tester des événements sans déclencher d'actions.

Séquence de tests

Lors de la sélection de cette option, la centrale affiche l'écran de Séquence de test. Appuyer sur ESC à n'importe quelle étape pour revenir à l'écran principale du menu Tests.

Sequence de test Relais actives Appuyez une touche ESC pour quitter
--

Appuyer sur n'importe quelle touche pour procéder aux tests du système.

Sequence de test Alarme sonore Appuyez une touche ESC pour quitter

Cette fonction comprend treize écrans de test pour chaque composante de la centrale. Les trois premiers écrans effectuent l'essais des relais de l'alarme sonore et des DEL.

Les six prochains écrans demande la pression sur les touches gauche, droite, haut, bas, Silence, Enter et ESC. Le système avance seulement lors de la pression sur une touche.

Sequence de test Presser 'gauche' ESC pour quitter
--

Le système essaye ensuite l'écran d'affichage; un écran en blanc est affiché. Appuyer n'importe quelle touche pour procéder à l'écran suivant.

Sequence de test Test affichage Pressez une touche ESC pour quitter
--

Le dernier test est l'essais de communication de réseau :

Sequence de test Test comm. reseau 9600 bauds Channel 1 SUCCES

Assitôt ces essais commencés, il n'est pas possible de les interrompre ou de les arrêter. Le système essaye chacun des cinq bauds (vitesse de communication : 9600, 19200, 38400, 57600, 115200) et chacun des quatre canaux par baud.

Aussitôt les essais terminés, le système affiche l'écran de sortie du mode Séquence de test. Appuyer sur n'importe quelle touche pour revenir à l'écran principale du menu Tests.

Sequence de test Test termine Pressez une touche
--

Mode Normal

Ceci est le mode d'opération normal (par défaut) du système. Lorsque le système est en mode normal, certaines valeurs peuvent être modifiées sans interruption de services. Toute modification est validée et effectuée lors du retour à l'écran principale.

Mode Émetteur unique

Ce mode permet d'effectuer l'analyse de transmetteurs, un à la fois. La centrale interroge seulement le transmetteur précisé, ce qui met à jour seulement les données de ce transmetteur. Ce mode n'entrave pas les fonctions d'évaluation d'événements.

Mode Débogage

Ce mode permet d'évaluer et d'effectuer des essais complets d'opération de système sans affecter les opérations (hors le mode débogage). **Les événements sont évalués et affichés, si nécessaire, mais aucune action n'est activée.**

Mode Simulation

Ce mode désactive les mises à jour d'information de communication de réseau. Ce mode peut être employé, peu importe quel est le mode d'opération actuel du système (exemple: l'emploi du mode Simulation simultanément avec le mode Débogage permet d'évaluer le système au complet [groupes, événements, etc.] sans déclencher des actions ou sans utilisation de matériel supplémentaire). Il permet de simuler des concentrations de gaz sur une plage associée à chaque transmetteur, en séquence :

Les niveaux d'alarme A, B et C sont évalués selon la concentration de gaz et les événements sont évalués et les actions sont déclenchées.

Pendant la simulation, la centrale ne connaît pas l'état actuel de la composante de réseau. Il est possible d'arrêter ce mode en tout temps depuis le menu Tests (voir Mode Normal).

Si l'un de ces modes est activé, mais qu'il n'y a aucune activité le système retourne à son opération normal après douze heures d'inactivité (de clavier). Aucune information n'est perdue.

9. Menu BACnet

Le menu BACNet sur la page suivante vous propose plusieurs écrans de menu principal pour configurer la connexion BACNET IP, le protocole DHCP, le serveur, les renseignements sur le fuseau horaire et plus encore. La mise en place des changements de paramètres de communication sur l'interface BACnet peut prendre jusqu'à 30 secondes après la modification. Ces paramètres incluent l'ID de l'appareil, l'adresse IP et le masque de sous-réseau.

Le contrôleur 301C ne fonctionne pas comme un BBMD. Si un BBMD est nécessaire, par exemple, lorsque la communication BACnet doit passer par un routeur, celui-ci doit être un dispositif externe.

La fonction de 301C «foreign device registration» ne est pas fonctionnel.

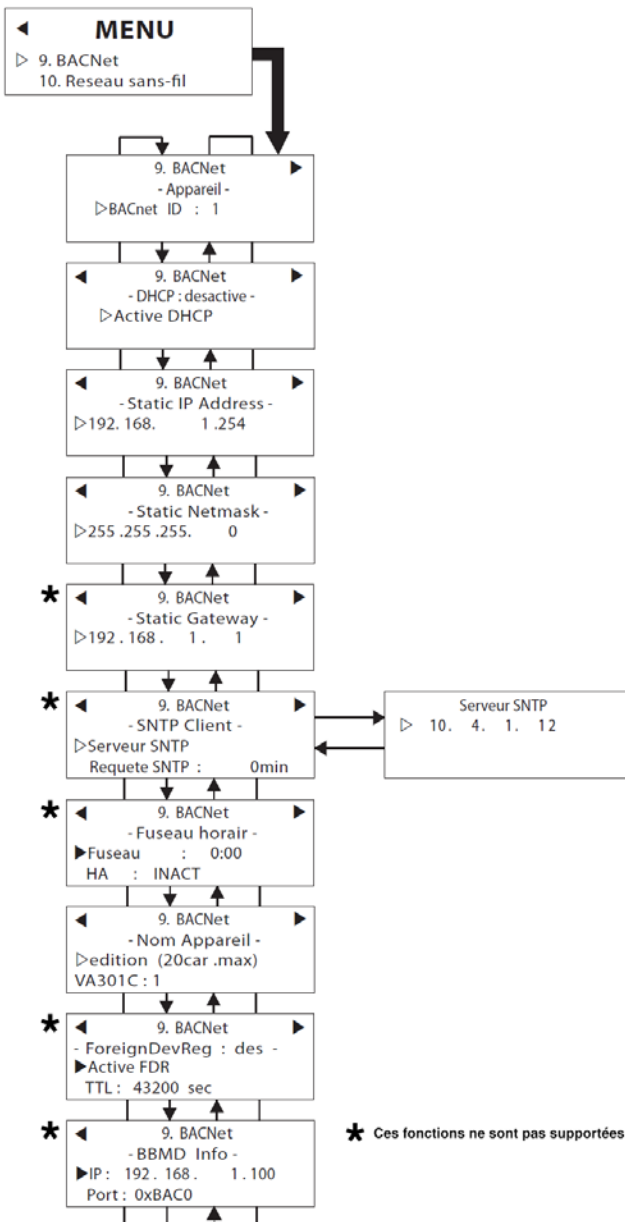

Le premier écran permet de configurer l'identification et l'adresse :

```
9. BACNet      →
-Appareil-
BACnet ID : 1
Adresse statque IP
```

BACnet ID : (Building Automation and Control Networks) est le numéro assigné à une centrale sur le réseau.

```
◀ 9. BACNet ▶
-Static IP Address-
▷192.168. 1.254
```

Adresse IP statque : Ceci est une adresse qui est toujours assignée à une centrale en particulier (plutôt que recyclé et réassigné lorsque la centrale ne l'utilise plus)

Changer les valeurs BACNet

- Utiliser les flèches pour déplacer le curseur à gauche du paramètre désiré puis appuyer sur Enter pour le sélectionner.
- La sélection de BACnet ID active le mode édition du champs. Utiliser les flèches pour augmenter ou diminuer la valeur ID (0-419303).

La sélection de l'option Adresse statque IP ouvre l'écran de modification de l'adresse IP. Toutes les centrales sont configurées avec une adresse par défaut.

```
-Adresse IP-
→ 192.168. 1.254
-Masque du reseau-
255.255.255. 0
```

Le deuxième écran permet d'activer ou de désactiver le protocole DHCP (Dynamic Host Configuration Protocol).

```
9. BACNet
-DHCP : desactive-
→ Active DHCP
```

Appuyer sur la touche Enter pour basculer le champs Activer ou Désactiver DHCP. **Consulter votre service de TI pour de plus amples informations sur le DHCP.**

L'écran Nom du dispositif permet d'attribuer un nom spécifique à l'appareil BACNet.

```
← 9. BACNet
-Device Name-
→ edit (20 char.max)
301C:1
```

Pour plus de renseignements sur ce sujet, veuillez consulter la norme ASHRAE, référence 135-2001, annexe J, section J5.

Le numéro de port de BACnet est fixe : 0xBAC0 en hexadécimal ou 47808 en décimal. Il ne fonctionne pas avec d'autres numéros de port.

Ordre de priorité des relais

Lors du calcul de l'état des sorties numériques tels que les relais, le 301C donne une plus grande priorité à l'BACnet commandes en relation avec les événements de gaz internes. Ceci est illustré graphiquement ci-dessous.

Priorité d'écriture BACnet 1 - Manuelle - Sécurité des personnes
Priorité d'écriture BACnet 2 - Automatique - Sécurité des personnes
Priorité d'écriture BACnet 3 -
Priorité d'écriture BACnet 4 -
Priorité d'écriture BACnet 5 - Contrôle des équipements critiques
Priorité d'écriture BACnet 6 - Marche/arrêt min.
Priorité d'écriture BACnet 7 -
Priorité d'écriture BACnet 8 - Opérateur manuel
Priorité d'écriture BACnet 9 -
Priorité d'écriture BACnet 10 -
Priorité d'écriture BACnet 11 -
Priorité d'écriture BACnet 12 -
Priorité d'écriture BACnet 13 -
Priorité d'écriture BACnet 14 -
Priorité d'écriture BACnet 15 -
Priorité d'écriture BACnet 16 -
Événements internes du 301C

L'intégrité du système de détection de gaz peut être compromise en cas de trafic erroné ou malveillant sur BACnet. Pour atténuer ce risque, certains relais de la version 19 et des versions ultérieures du logiciel BACnet sont insensibles aux commandes BACnet. Cela affecte les relais 301C 3 et 4 et les relais 301R de 5 à 8 sur tous les modules 301R. D'autres relais et tous les vibreurs restent pilotables par BACnet. Le relais E³Point reste pilotable par BACnet.

Les concepteurs de réseau sont invités à utiliser ces relais BACnet-immune pour les fonctions de sécurité critiques lorsque le trafic malveillant BACnet est présent. Dans les cas où une sortie doit activer en réponse à des événements soit de gaz ou une commande de BACnet, Honeywell recommande câblage des contacts de deux relais en parallèle pour une porte OU câblé.

APDU_segment_timeout

Le 301C instancie de manière dynamique les objets BACnet chaque fois que l'opération « Réinitialiser et analyser » est exécutée. Plusieurs objets sont créés pour chaque émetteur. Le nombre dépend du type d'émetteur. Par exemple, pour chaque E³Point, le 301C crée neuf objets. Par conséquent, le nombre d'objets BACnet peut être important : jusqu'à 869 dans le pire des cas en présence de 96 E³Point. Il en résulte notamment que la réponse du contrôleur aux clients BACnet externes peut être relativement lente. Malheureusement, certains clients BACnet ont une valeur APDU_segment_timeout trop petite pour une utilisation avec le contrôleur 301C. Cela se manifeste parfois par l'absence de réponse du contrôleur aux demandes de communication. Honeywell recommande donc que tous les clients BACnet qui communiquent avec le contrôleur 301C possèdent des délais d'attente définis comme indiqué dans le tableau ci-dessous :

Nombre d'émetteurs reliés au contrôleur 301C	Valeur APDU_segment_timeout (en millisecondes) pour les clients BACnet qui doivent communiquer avec les objets 301C
0 à 10	5000
11 à 34	10 000
35 à 96	20 000

Module BACnet/IP

(Option BIP)

Spécifications

Port Ethernet : 10 base-T, RJ-45

Indicateurs visuels : Voyant DEL vert LINK
Voyant DEL jaune ACT

Configuration du réseau : Voir la section sur le menu BACnet du 301C.

Protocole BACnet/IP

Port UDP : 47808. Cette valeur n'est pas modifiable par le biais du 301C.

Le module a été développé conformément à la norme ANSI/ASHRAE 135-2001 : BACnet®— Protocole de communication de données pour l'immatériel et les réseaux de contrôle. L'option Couche liaison de données est conforme à BACnet/IP (annexe J).

<http://www.ashrae.org/>

Les tableaux des pages 184 à 206 sont également disponibles sur le CD des produits commerciaux de Honeywell Analytics livré avec le contrôleur 301C et dans la bibliothèque technique de Honeywell Analytics (www.honeywellanalytics.com > Products > Commercial Solutions > 301C > Technical Library).

Device Object

Group	Property	Data Type	Required ¹	Storage Type ²	BACnet Writeable?	Value
Device	object_identifier	unsigned	R	N	N	Set from LUI
	object_type	enumerated	R	C	N	device (8)
	vendor_identifier	enumerated	R	C	N	Honeywell Inc. (17)
	apdu_timeout	unsigned	R	C	N	0
	application_software_version	character string	R	C	N	"1.1"
	firmware_revision	character string	R	C	N	"1.3.18"
	max_apdu_length_accepted	unsigned	R	C	N	1476
	model_name	character string	R	C	N	"301C-BIP"
	number_of_apdu_retries	unsigned	R	C	N	0
	object_name	character string	R	N	N	default "VA301C:1", settable from LUI.
	protocol_object_types_supported	bit string	R	C	N	analog_input, analog_output, analog_value, binary_input, binary_value, device
	protocol_services_supported	bit string	R	C	N	readProperty, readPropertyMultiple, writeProperty, deviceCommunicationControl, reinitializeDevice, i_Am, i_Have, timeSynchronization, who_Has, who_Is,
	protocol_version	unsigned	R	C	N	1
	segmentation_supported	enumerated	R	C	N	no_segmentation (3)
	system_status	enumerated	R	C	N	operational (0)
	vendor_name	character string	R	C	N	Honeywell
	protocol_revision	unsigned	R	C	N	2
	database_revision	unsigned	R	C	N	not meaningful
	Notes					
	1 --	'R' indicates that this property is required by ASHRAE Standard 135				
		'O' indicates that the property is optional in ASHRAE Standard 135				
	2 --	'C' indicates the property is hard-coded as a constant				
		'N' indicates the property is stored in non-volatile memory				
		'R' indicate the property is computed constantly and stored in RAM.				

Objets de base

Group	Property	Data Type	Required ¹	Storage Type ²	BACnet Writeable?	Value	
Binary Outputs	rel1 to rel4	object_identifier	R	C	N	46344 (or 0xB508) for Relay #1 up to 46347 (or 0xB50B) for Relay #4	
		object_type	enumerated	R	C	N	binary_output (4)
		event_state	enumerated	R	C	N	normal (0)
		object_name	character string	R	N	N	"device_object_name.relX", where device_object_name is programmed on the LUI and defaults to "VA301C:1" and X is relay number (1 to 4). Thus the default object_name for Relay #4 will be "VA301C:1.rel4"
		out_of_service	boolean	R	C	N	FALSE
		polarity	enumerated	R	C	N	always Normal (0)
		present_value	enumerated	R	R	Only Rly1&2. Not Rly 3or4.	True state of the relays. These take the value of the highest-priority BACnet command. If no BACnet command, this takes the value of the associated event.
		priority_array		R	R	N	last value written
		reliability	enumerated	O	C	N	no_fault_detected (0)
		relinquish_default		R	C	N	not meaningful
		active_text	character string	O	C	N	"ON"
		inactive_text	character string	O	C	N	"OFF"
		status_flags					
		in_alarm	boolean	R	C	N	always "false" (0)
	fault	boolean	R	C	N	always "false" (0)	
	overridden	boolean	R	R	N	always "false" (0)	
	out_of_service	boolean	R	R	N	always "false" (0)	
	buzz	object_identifier		R	C	N	46360 (or 0xB518)
		object_type	enumerated	R	C	N	binary_output (4)
		event_state	enumerated	R	C	N	normal (0)
		object_name	character string	R	N	N	"device_object_name.buzz", where device_object_name is programmed on the LUI and defaults to "VA301C:1". Thus the default object_name will be "VA301C:1.buzz"
		out_of_service	boolean	R	C	N	FALSE
		polarity	enumerated	R	C	N	always Normal (0)
		present_value	enumerated	R	R	Y	True state of the buzzer. This takes the value of the highest-priority BACnet command. If no BACnet command, this takes the value of the associated event.
		priority_array		R	R	N	last value written
		reliability	enumerated	O	C	N	no_fault_detected (0)
		relinquish_default		R	C	N	not meaningful
		status_flags					
in_alarm		boolean	R	C	N	always "false" (0)	
fault		boolean	R	C	N	always "false" (0)	
overridden		boolean	R	C	N	always "false" (0)	
out_of_service	boolean	R	C	N	always "false" (0)		
Notes							
1 --	'R' indicates that this property is required by ASHRAE Standard 135 'O' indicates that the property is optional in ASHRAE Standard 135						
2 --	'C' indicates the property is hard-coded as a constant 'N' indicates the property is stored in non-volatile memory 'R' indicate the property is computed constantly and stored in RAM.						

IAQPoint2

Group	Property	Data Type	Required ¹	Storage Type ²	BACnet Writeable?	Value	
Analog Input	IAQPoint CO2	object_identifier	R	C	N	Modbus address * 256 + 1. For example an IAQPoint2 at Modbus address 005 will appear as 1281 or 0x0501.	
		object_type	enumerated	R	C	N	analog_input (0)
		event_state	enumerated	R	R	N	if gas sensor fault Fault (1), else normal (0)
		object_name	character string	R	N	N	"IAQPoint CO2 AdXXX.CO2" where XXX is the Modbus address.
		out_of_service	boolean	R	R	N	FALSE
		present_value	real	R	R	N	Gas reading if CO2 fitted, 0 to 5000 if VOC fitted, 0 to 100
		reliability	enumerated	O	R	N	As appropriate reports no_fault_detected (0) or no_sensor (1) or unreliable other (7) Fault is detected within 60 seconds
		status_flags					
		in_alarm	boolean	R	R	N	if faulty "true" (1) else "false" (0)
		fault	boolean	R	R	N	if faulty "true" (1) else "false" (0)
		overridden	boolean	R	R	N	"false" (0)
		out_of_service	boolean	R	R	N	"false" (0)
		units	enumerated	R	N	N	if CO2 fitted, ppm (96) if VOC fitted, % (98)
		Analog Input	IAQPoint ToC	object_identifier	R	C	N
object_type	enumerated			R	C	N	analog_input (0)
event_state	enumerated			R	R	N	if temp sensor fault, fault (1), else normal (0)
object_name	character string			R	N	N	"IAQPoint ToC AdXXX.ToC" where XXX is the Modbus address plus one.
out_of_service	boolean			R	R	N	FALSE
present_value	real			R	R	N	Temperature reading in Celcius, regardless of IAQPoint2 configuration.
reliability	enumerated			O	R	N	As appropriate reports no_fault_detected (0) or no_sensor (1) or unreliable other (7) Fault is detected within 60 seconds
status_flags							
in_alarm	boolean			R	R	N	if not purchased or faulty "true" (1) else "false" (0)
fault	boolean			R	R	N	if not purchased or faulty "true" (1) else "false" (0)
overridden	boolean			R	C	N	False (0)
out_of_service	boolean			R	R	N	"false" (0)
units	enumerated			R	N	N	Celcius (62)
Notes							
1 --	'R' indicates that this property is required by ASHRAE Standard 135						
	'O' indicates that the property is optional in ASHRAE Standard 135						
2 --	'C' indicates the property is hard-coded as a constant						
	'N' indicates the property is stored in non-volatile memory						
	'R' indicate the property is computed constantly and stored in RAM.						

IAQPoint2 (suite)

Group	Property	Data Type	Required ¹	Storage Type ²	BACnet Writeable?	Value	
Analog Inputs IAQPoint RH	object_identifier		R	C	N	Sensor number * 256 + 1. Sensor number for RH is Modbus address + 2. For example an IAQPoint2 at Modbus address 005 will appear as 1793 or 0x0701.	
	object_type	enumerated	R	C	N	analog_input (0)	
	event_state	enumerated	R	R	N	if temp sensor fault, fault (1), else normal (0)	
	object_name	character string	R	N	N	"IAQPoint RH AdXXX.RH" where XXX is the Modbus address plus two.	
	out_of_service	boolean	R	R	N	FALSE	
	present_value	real	R	R	N	Relative Humidity in percent	
	reliability	enumerated	O	R	N	As appropriate reports no_fault_detected (0) or no_sensor (1) or unreliable other (7) Fault is detected within 60 seconds	
	status_flags						
	in_alarm	boolean	R	R	N	if not purchased or faulty "true" (1) else "false" (0)	
	fault	boolean	R	R	N	if not purchased or faulty "true" (1) else "false" (0)	
	overridden	boolean	R	C	N	False (0)	
	out_of_service	boolean	R	R	N	False (0)	
	units	enumerated	R	N	N	percent relative humidity (29)	
Notes							
1 --	'R' indicates that this property is required by ASHRAE Standard 135						
	'O' indicates that the property is optional in ASHRAE Standard 135						
2 --	'C' indicates the property is hard-coded as a constant						
	'N' indicates the property is stored in non-volatile memory						
	'R' indicate the property is computed constantly and stored in RAM.						
continued...							

IAQPoint2 (suite)

Group	Property	Data Type	Required ¹	Storage Type ²	BACnet Writeable?	Value			
Analog Values	Amin	object_identifier	R	N	N	Modbus address * 256 + 2. For example an IAQPoint2 at Modbus address 005 will appear as 1282 or 0x0502.			
		object_type	enumerated	R	C	N	analog_value (2)		
		event_state	enumerated	R	C	N	normal (0)		
		object_name	character string	R	N	N	IAQPoint CO2 AdXXX.Amin" where XXX is the Modbus address.		
		out_of_service	boolean	R	C	N	FALSE		
		present_value	real	R	N	Y	Gas threshold less hysteresis. This is copied from the sensor via the 301C. BACnet permits writing. But this has no effect and the value reverts in a few seconds.		
		reliability	enumerated	O	C	N	no_fault_detected (0)		
		status_flags							
		in_alarm	boolean	R	C	N	always false (0)		
		fault	boolean	R	C	N	always false (0)		
		overridden	boolean	R	C	N	always false (0)		
		out_of_service	boolean	R	C	N	always false (0)		
		units	enumerated	R	C	N	if CO2 fitted, ppm (96) if VOC fitted, % (98)		
		Analog Values	Amax	object_identifier	R	N	N	Modbus address * 256 + 3. For example an IAQPoint2 at Modbus address 005 will appear as 1283 or 0x0503.	
				object_type	enumerated	R	C	N	analog_value (2)
				event_state	enumerated	R	C	N	normal (0)
				object_name	character string	R	N	N	IAQPoint CO2 AdXXX.Amax" where XXX is the Modbus address.
out_of_service	boolean			R	C	N	FALSE		
present_value	real			R	N	Y	Gas threshold. This is copied from the sensor via the 301C. BACnet permits writing. But this has no effect and the value reverts in a few seconds.		
reliability	enumerated			O	C	N	no_fault_detected (0)		
status_flags									
in_alarm	boolean			R	C	N	always false (0)		
fault	boolean			R	C	N	always false (0)		
overridden	boolean			R	C	N	always false (0)		
out_of_service	boolean			R	C	N	always false (0)		
units	enumerated			R	C	N	if CO2 fitted, ppm (96) if VOC fitted, % (98)		
Notes	<p>1 -- 'R' indicates that this property is required by ASHRAE Standard 135 'O' indicates that the property is optional in ASHRAE Standard 135</p> <p>2 -- 'C' indicates the property is hard-coded as a constant 'N' indicates the property is stored in non-volatile memory 'R' indicate the property is computed constantly and stored in RAM.</p>								
	continued...								

IAQPoint2 (suite)

Group	Property	Data Type	Required ¹	Storage Type ²	BACnet Writeable?	Value	
Analog Values	Bmin	object_identifier	R	N	N	Modbus address * 256 + 4. For example an IAQPoint2 at Modbus address 005 will appear as 1284 or 0x0504.	
		object_type	enumerated	R	C	N	analog_value (2)
		event_state	enumerated	R	C	N	normal (0)
		object_name	character string	R	N	N	IAQPoint CO2 AdXXX.Bmin" where XXX is the Modbus address.
		out_of_service	boolean	R	C	N	FALSE
		present_value	real	R	N	Y	Gas threshold. This is copied from the sensor via the 301C. BACnet permits writing. But this has no effect and the value reverts in a few seconds.
		reliability	enumerated	O	C	N	no_fault_detected (0)
		status_flags					
		in_alarm	boolean	R	C	N	always false (0)
		fault	boolean	R	C	N	always false (0)
	overridden	boolean	R	C	N	always false (0)	
	out_of_service	boolean	R	C	N	always false (0)	
	units	enumerated	R	C	N	if CO2 fitted, ppm (96) if VOC fitted, % (98)	
	Bmax	object_identifier		R	N	N	Modbus address * 256 + 5. For example an IAQPoint2 at Modbus address 005 will appear as 1285 or 0x0505.
		object_type	enumerated	R	C	N	analog_value (2)
		event_state	enumerated	R	C	N	normal (0)
		object_name	character string	R	N	N	IAQPoint CO2 AdXXX.Bmax" where XXX is the Modbus address.
		out_of_service	boolean	R	C	N	FALSE
		present_value	real	R	N	Y	Gas threshold. This is copied from the sensor via the 301C. BACnet permits writing. But this has no effect and the value reverts in a few seconds.
		reliability	enumerated	O	C	N	no_fault_detected (0)
status_flags							
in_alarm		boolean	R	C	N	always false (0)	
fault		boolean	R	C	N	always false (0)	
overridden	boolean	R	C	N	always false (0)		
out_of_service	boolean	R	C	N	always false (0)		
units	enumerated	R	C	N	if CO2 fitted, ppm (96) if VOC fitted, % (98)		
Notes							
	1 --	'R' indicates that this property is required by ASHRAE Standard 135					
		'O' indicates that the property is optional in ASHRAE Standard 135					
	2 --	'C' indicates the property is hard-coded as a constant					
		'N' indicates the property is stored in non-volatile memory					
		'R' indicate the property is computed constantly and stored in RAM.					

E3Point

Group	Property	Data Type	Required ¹	Storage Type ²	BACnet Writeable?	Value
analog_input gas	object_identifier		R	C	N	Modbus address * 256 + 1. For example an E3Point at Modbus address 009 will appear as 2305 or 0x0901.
	object_type	enumerated	R	C	N	analog_input (0)
	event_state	enumerated	R	R	N	if gas sensor fault Fault (1), else normal (0)
	object_name	character string	R	N	N	"E3POINT GGGG AdXXX.GGGG" where GGGG is the gas name and XXX is the Modbus address. Values for gas name include "CO" and "COMB".
	out_of_service	boolean	R	R	N	FALSE
	present_value	real	R	R	N	Gas reading
	reliability	enumerated	O	R	N	As appropriate reports no_fault_detected (0) or unreliable other (7) Fault is detected within 60 seconds
	status_flags					
	in_alarm	boolean	R	R	N	if alarm or fault "true" (1) else "false" (0)
	fault	boolean	R	R	N	if faulty "true" (1) else "false" (0)
	overridden	boolean	R	R	N	"false" (0)
	out_of_service	boolean	R	R	N	"false" (0)
	units	enumerated	R	N	N	ppm (96) or % (98)
Notes						
1 --	'R' indicates that this property is required by ASHRAE Standard 135 'O' indicates that the property is optional in ASHRAE Standard 135					
2 --	'C' indicates the property is hard-coded as a constant 'N' indicates the property is stored in non-volatile memory 'R' indicate the property is computed constantly and stored in RAM.					
						continued...

E3Point (suite)

Group	Property	Data Type	Required ¹	Storage Type ²	BACnet Writable?	Value	
Analog Values	Amin	object_identifier	R	N	N	Modbus address * 256 + 2. For example an E3Point at Modbus address 000 will appear as 2306 or 0x0902.	
		object_type	enumerated	R	C	N	analog_value (2)
		event_state	enumerated	R	C	N	normal (0)
		object_name	character string	R	N	N	"E3POINT GGGG AdXXX.Amin" where GGGG is the gas name and XXX is the Modbus address. Values for gas name include "CO" and "COMB".
		out_of_service	boolean	R	C	N	FALSE
		present_value	real	R	N	Y	Gas threshold less hysteresis. Synchronization is maintained with the 301C and the E3Point. Whichever value is written last is distributed to the other two locations.
		reliability	enumerated	O	C	N	no_fault_detected (0)
		status_flags					
		in_alarm	boolean	R	C	N	always false (0)
		fault	boolean	R	C	N	always false (0)
		overridden	boolean	R	C	N	always false (0)
	out_of_service	boolean	R	C	N	always false (0)	
	units	enumerated	R	C	N	ppm (96) or % (98)	
	Amax	object_identifier		R	N	N	Modbus address * 256 + 3. For example an E3Point at Modbus address 009 will appear as 2307 or 0x0903.
		object_type	enumerated	R	C	N	analog_value (2)
		event_state	enumerated	R	C	N	normal (0)
		object_name	character string	R	N	N	"E3POINT GGGG AdXXX.Amax" where GGGG is the gas name and XXX is the Modbus address. Values for gas name include "CO" and "COMB".
		out_of_service	boolean	R	C	N	FALSE
		present_value	real	R	N	Y	Gas threshold. Synchronization is maintained with the 301C and the E3Point. Whichever value is written last is distributed to the other two locations.
		reliability	enumerated	O	C	N	no_fault_detected (0)
		status_flags					
		in_alarm	boolean	R	C	N	always false (0)
fault		boolean	R	C	N	always false (0)	
overridden		boolean	R	C	N	always false (0)	
out_of_service	boolean	R	C	N	always false (0)		
units	enumerated	R	C	N	ppm (96) or % (98)		
Notes							
1 --		'R' indicates that this property is required by ASHRAE Standard 135					
		'O' indicates that the property is optional in ASHRAE Standard 135					
2 --		'C' indicates the property is hard-coded as a constant					
		'N' indicates the property is stored in non-volatile memory					
		'R' indicate the property is computed constantly and stored in RAM.					
continued...							

E³Point (suite)

Group	Property	Data Type	Required ¹	Storage Type ²	BACnet Writeable?	Value	
Analog Values	Bmin	object_identifier	R	N	N	Modbus address * 256 + 4. For example an E3Point at Modbus address 009 will appear as 2308 or 0x0904.	
		object_type	enumerated	R	C	N	analog_value (2)
		event_state	enumerated	R	C	N	normal (0)
		object_name	character string	R	N	N	"E3POINT GGGG AdXXX.Bmin" where GGGG is the gas name and XXX is the Modbus address. Values for gas name include "CO" and "COMB".
		out_of_service	boolean	R	C	N	FALSE
		present_value	real	R	N	Y	Gas threshold less hysteresis. Synchronization is maintained with the 301C and the E3Point. Whichever value is written last is distributed to the other two locations.
		reliability	enumerated	O	C	N	no_fault_detected (0)
		status_flags					
		in_alarm	boolean	R	C	N	always false (0)
		fault	boolean	R	C	N	always false (0)
	overridden	boolean	R	C	N	always false (0)	
	out_of_service	boolean	R	C	N	always false (0)	
	units	enumerated	R	C	N	ppm (96) or % (98)	
	Bmax	object_identifier		R	N	N	Modbus address * 256 + 5. For example an E3Point at Modbus address 009 will appear as 2309 or 0x0905.
		object_type	enumerated	R	C	N	analog_value (2)
		event_state	enumerated	R	C	N	normal (0)
		object_name	character string	R	N	N	"E3POINT GGGG AdXXX.Bmax" where GGGG is the gas name and XXX is the Modbus address. Values for gas name include "CO" and "COMB".
		out_of_service	boolean	R	C	N	FALSE
		present_value	real	R	N	Y	Gas threshold. Synchronization is maintained with the 301C and the E3Point. Whichever value is written last is distributed to the other two locations.
		reliability	enumerated	O	C	N	no_fault_detected (0)
status_flags							
in_alarm		boolean	R	C	N	always false (0)	
fault		boolean	R	C	N	always false (0)	
overridden	boolean	R	C	N	always false (0)		
out_of_service	boolean	R	C	N	always false (0)		
units	enumerated	R	C	N	ppm (96) or % (98)		
Notes							
1 --	'R' indicates that this property is required by ASHRAE Standard 135						
	'O' indicates that the property is optional in ASHRAE Standard 135						
2 --	'C' indicates the property is hard-coded as a constant						
	'N' indicates the property is stored in non-volatile memory						
	'R' indicate the property is computed constantly and stored in RAM.						
						continued...	

E3Point (suite)

Group	Property	Data Type	Required ¹	Storage Type ²	BACnet Writeable?	Value	
Analog Values	Cmin	object_identifier	R	N	N	Modbus address * 256 + 6. For example an E3Point at Modbus address 009 will appear as 2310 or 0x0906.	
		object_type	enumerated	R	C	N	analog_value (2)
		event_state	enumerated	R	C	N	normal (0)
		object_name	character string	R	N	N	"E3POINT GGGG AdXXX.Cmin" where GGGG is the gas name and XXX is the Modbus address. Values for gas name include "CO" and "COMB".
		out_of_service	boolean	R	C	N	FALSE
		present_value	real	R	N	Y	Gas threshold less hysteresis. Synchronization is maintained with the 301C and the E3Point. Whichever value is written last is distributed to the other two locations.
		reliability	enumerated	O	C	N	no_fault_detected (0)
		status_flags					
		in_alarm	boolean	R	C	N	always false (0)
		fault	boolean	R	C	N	always false (0)
	overridden	boolean	R	C	N	always false (0)	
	out_of_service	boolean	R	C	N	always false (0)	
	units	enumerated	R	C	N	ppm (96) or % (98)	
	Cmax	object_identifier		R	N	N	Modbus address * 256 + 7. For example an E3Point at Modbus address 009 will appear as 2311 or 0x0907.
		object_type	enumerated	R	C	N	analog_value (2)
		event_state	enumerated	R	C	N	normal (0)
		object_name	character string	R	N	N	"E3POINT GGGG AdXXX.Cmax" where GGGG is the gas name and XXX is the Modbus address. Values for gas name include "CO" and "COMB".
		out_of_service	boolean	R	C	N	FALSE
		present_value	real	R	N	Y	Gas threshold. Synchronization is maintained with the 301C and the E3Point. Whichever value is written last is distributed to the other two locations.
		reliability	enumerated	O	C	N	no_fault_detected (0)
status_flags							
in_alarm		boolean	R	C	N	always false (0)	
fault		boolean	R	C	N	always false (0)	
overridden	boolean	R	C	N	always false (0)		
out_of_service	boolean	R	C	N	always false (0)		
units	enumerated	R	C	N	ppm (96) or % (98)		
	Notes						
	1 --					'R' indicates that this property is required by ASHRAE Standard 135	
						'O' indicates that the property is optional in ASHRAE Standard 135	
	2 --					'C' indicates the property is hard-coded as a constant	
						'N' indicates the property is stored in non-volatile memory	
						'R' indicate the property is computed constantly and stored in RAM.	
						continued...	

E3Point (suite)

Group	Property	Data Type	Required ¹	Storage Type ²	BACnet Writeable?	Value	
Binary Outputs	rel1 (relay buzzer)	object_identifier	R	C	N	Modbus address * 256 + 8. For example an E3Point at Modbus address 009 will appear as 2312 or 0x0908.	
		object_type	enumerated	R	C	N	binary_output (4)
		event_state	enumerated	R	C	N	normal (0)
		object_name	character string	R	N	N	"E3POINT GGGG AdXXX.rel1" where GGGG is the gas name and XXX is the Modbus address. Values for gas name include "CO" and "COMB".
		out_of_service	boolean	R	C	N	FALSE
		polarity	enumerated	R	C	N	always Normal (0)
		present_value	enumerated	R	R	Y	Reading this reports the true state of the buzzer. Mixing BACnet and event control of this output is not supported.
		priority_array		R	R	N	last value written
		reliability	enumerated	O	C	N	no_fault_detected (0)
		relinquish_default		R	C	N	not meaningful.
	active_text	character string	O	C	N	"ON"	
	inactive_text	character string	O	C	N	"OFF"	
	status_flags						
	in_alarm	boolean	R	C	N	always "false" (0)	
	fault	boolean	R	C	N	always "false" (0)	
	overridden	boolean	R	R	N	always "false" (0)	
	out_of_service	boolean	R	R	N	always "false" (0)	
	rel2 (physical relay)	object_identifier		R	C	N	Modbus address * 256 + 9. For example an E3Point at Modbus address 009 will appear as 2313 or 0x0909.
		object_type	enumerated	R	C	N	binary_output (4)
		event_state	enumerated	R	C	N	normal (0)
object_name		character string	R	N	N	"E3POINT GGGG AdXXX.rel2" where GGGG is the gas name and XXX is the Modbus address. Values for gas name include "CO" and "COMB".	
out_of_service		boolean	R	C	N	FALSE	
polarity		enumerated	R	C	N	always Normal (0)	
present_value		enumerated	R	R	Y	Reading this reports the true state of the relay. Mixing BACnet and event control of this output is not supported.	
priority_array			R	R	N	last value written	
reliability		enumerated	O	C	N	no_fault_detected (0)	
relinquish_default			R	C	N	not meaningful.	
status_flags							
in_alarm	boolean	R	C	N	always "false" (0)		
fault	boolean	R	C	N	always "false" (0)		
overridden	boolean	R	C	N	always "false" (0)		
out_of_service	boolean	R	C	N	always "false" (0)		
Notes							
1 --	'R' indicates that this property is required by ASHRAE Standard 135						
	'O' indicates that the property is optional in ASHRAE Standard 135						
2 --	'C' indicates the property is hard-coded as a constant						
	'N' indicates the property is stored in non-volatile memory						
	'R' indicate the property is computed constantly and stored in RAM.						

XXN et XCD

Group	Property	Data Type	Required ¹	Storage Type ²	BACnet Writeable?	Value
analog_input gas	object_identifier		R	C	N	Modbus address * 256 + 1. For example an XXN at Modbus address 010 will appear as 2561 or 0x0A01.
	object_type	enumerated	R	C	N	analog_input (0)
	event_state	enumerated	R	R	N	if gas sensor fault Fault (1), else normal (0)
	object_name	character string	R	N	N	"SSS GGGG AdAAA.GGGGG" where SSS is the sensor type, GGGG is the gas name and AAA is the Modbus address. Gas names are truncated to 4 and 5 characters. Values for sensor type are "XXN" or "XCD" For example, an XXN at address 10 with a Methane sensor will populate this object name with "XXN Meth Ad010.Metha"
	out_of_service	boolean	R	R	N	FALSE
	present_value	real	R	R	N	Gas reading
	reliability	enumerated	O	R	N	As appropriate reports no_fault_detected (0) or unreliable other (7) Fault is detected within 60 seconds
	status_flags					
	in_alarm	boolean	R	R	N	if faulty "true" (1) else "false" (0)
	fault	boolean	R	R	N	if faulty "true" (1) else "false" (0)
	overridden	boolean	R	R	N	"false" (0)
	out_of_service	boolean	R	R	N	"false" (0)
	units	enumerated	R	N	N	96 (ppm) or 98 (percent) or 95 (no_units)
Notes						
1 --	'R' indicates that this property is required by ASHRAE Standard 135 'O' indicates that the property is optional in ASHRAE Standard 135					
2 --	'C' indicates the property is hard-coded as a constant 'N' indicates the property is stored in non-volatile memory 'R' indicate the property is computed constantly and stored in RAM.					
						continued...

XXN et XCD (suite)

Group	Property	Data Type	Required ¹	Storage Type ²	BACnet Writeable?	Value	
Analog Values	AlarmA	object_identifier	R	N	N	Modbus address * 256 + 2. For example an XXN at Modbus address 010 will appear as 2562 or 0x0A02.	
		object_type	enumerated	R	C	N	analog_value (2)
		event_state	enumerated	R	C	N	normal (0)
		object_name	character string	R	N	N	"SSS GGGG AdAAA.AlarmA" where SSS is the sensor type, GGGG is the gas name and AAA is the Modbus address. Values for gas name include "CO" and "COMB". Gas names are truncated to 4 characters. Values for sensor type are "XXN" or "XCD" For example, an XXN at address 10 with a Methane sensor will populate this object name with "XXN Meth Ad010.AlarmA"
		out_of_service	boolean	R	C	N	FALSE
		present_value	real	R	N	N	Alarm1 threshold copied from sensor through the 301C. This may only be modified on the sensor.
		reliability	enumerated	O	C	N	always false (0)
		status_flags					
		in_alarm	boolean	R	C	N	always false (0)
	fault	boolean	R	C	N	always false (0)	
	overridden	boolean	R	C	N	always false (0)	
	out_of_service	boolean	R	C	N	always false (0)	
	units	enumerated	R	C	N	96 (ppm) or 98 (percent) or 95 (no_units)	
	AlarmB	object_identifier		R	N	N	Modbus address * 256 + 4. For example an XCD at Modbus address 011 will appear as 2820 or 0x0B04.
		object_type	enumerated	R	C	N	analog_value (2)
		event_state	enumerated	R	C	N	normal (0)
		object_name	character string	R	N	N	"SSS GGGG AdAAA.AlarmB" where SSS is the sensor type, GGGG is the gas name and AAA is the Modbus address. Gas names are truncated to 4 characters. Values for sensor type are "XXN" or "XCD" For example, an XCD at address 11 with an H2S sensor will populate this object name with "XCD H2S Ad011.AlarmB"
		out_of_service	boolean	R	C	N	FALSE
		present_value	real	R	N	N	Alarm2 threshold copied from sensor through the 301C. This may only be modified on the sensor.
reliability		enumerated	O	C	N	no_fault_detected (0)	
status_flags							
in_alarm		boolean	R	C	N	always false (0)	
fault		boolean	R	C	N	always false (0)	
overridden	boolean	R	C	N	always false (0)		
out_of_service	boolean	R	C	N	always false (0)		
units	enumerated	R	C	N	96 (ppm) or 98 (percent) or 95 (no_units)		
Notes	1 --	'R' indicates that this property is required by ASHRAE Standard 135 'O' indicates that the property is optional in ASHRAE Standard 135					
	2 --	'C' indicates the property is hard-coded as a constant 'N' indicates the property is stored in non-volatile memory					

Objets du 301EM

Group	Property	Data Type	Required ¹	Storage Type ²	BACnet Writeable?	Value		
analog_input	Gas (One instance per sensor on the 301EM.)	object_identifier	R	C	N	TxNumber * 256 + 1. The TxNumber is the Modbus address plus the sensor number in the 301EM. For example, sensor 2 on a 301EM at Modbus address 030 will appear as 7937 or 0x1F01.		
		object_type	enumerated	R	C	N	analog_input (0)	
		event_state	enumerated	R	R	N	not meaningful	
		object_name	character string	R	N	N	"VA301EM GGGG AdXXX.GGGG" where GGGG is the gas name and XXX is the Modbus address. Values for gas name include "R11" and "NH3".	
		out_of_service	boolean	R	R	N	FALSE	
		present_value	real	R	R	N	Gas reading	
		reliability	enumerated	O	R	N	As appropriate reports no_fault_detected (0), no_sensor (1), or unreliable other (7)	
		status_flags					Fault is detected within 60 seconds	
		in_alarm	boolean	R	R	N	not meaningful	
		fault	boolean	R	R	N	if faulty "true" (1) else "false" (0)	
		overridden	boolean	R	R	N	"false" (0)	
		out_of_service	boolean	R	R	N	"false" (0)	
		units	enumerated	R	N	N	From 301EM, usually ppm (96)	
		Analog Values (six instances for each sensor on the 301EM, up to 120).	Amin, Amax, Bmin, Bmax, Cmin, Cn	object_identifier	R	N	N	For Amin, TxNumber * 256 + 2, For Amax, TxNumber * 256 + 3, For Bmin, TxNumber * 256 + 4, For Bmax, TxNumber * 256 + 5, For Cmin, TxNumber * 256 + 6, For Cmax, TxNumber * 256 + 7 The TxNumber is the Modbus address plus the sensor number in the 301EM.
				object_type	enumerated	R	C	N
event_state	enumerated			R	C	N	not meaningful.	
object_name	character string			R	N	N	"VA301EM GGGG AdXXX.LLLL" where GGGG is the gas name, XXX is the Modbus address plus the sensor number in the 301EM and LLLL is a member of the set {Amin, Amax, Bmin, Bmax, Cmin and Cmax}.	
out_of_service	boolean			R	C	N	FALSE	
present_value	real			R	N	N	Writing alarm thresholds over BACnet not supported.	
reliability	enumerated			O	C	N	not meaningful.	
status_flags								
in_alarm	boolean			R	C	N	not meaningful.	
fault	boolean			R	C	N	not meaningful.	
overridden	boolean			R	C	N	always false (0)	
out_of_service	boolean			R	C	N	always false (0)	
units	enumerated			R	C	N	ppm (96) or % (98)	
Notes								
1 --	'R' indicates that this property is required by ASHRAE Standard 135							
	'O' indicates that the property is optional in ASHRAE Standard 135							
2 --	'C' indicates the property is hard-coded as a constant							
	'N' indicates the property is stored in non-volatile memory							
	'R' indicate the property is computed constantly and stored in RAM.							

Objets du 301EM (suite)

Group	Property	Data Type	Required ¹	Storage Type ²	BACnet Writeable?	Value	
Binary Values (Four instances per 301EM, regardless of number of sensors.)	rel1 to rel4	object_identifier	R	C	N	For rel1, Modbus address * 256 + 8, For rel2, Modbus address * 256 + 9, For rel3, Modbus address * 256 + 10, For rel4, Modbus address * 256 + 11	
		object_type	enumerated	R	C	N	binary_values (5)
		event_state	enumerated	R	C	N	normal (0)
		object_name	character string	R	N	N	"VA301EM GGGG AdXXX.Rel" where GGGG is the gas name, XXX is the Modbus address and L is the relay number.
		out_of_service	boolean	R	C	N	FALSE
		present_value	enumerated	R	R	N	current state of relay
		reliability	enumerated	0	C	N	not meaningful.
		active_text	character string	O	C	N	"ON"
		status_flags					
		in_alarm	boolean	R	C	N	not meaningful.
	fault	boolean	R	C	N	not meaningful.	
	overridden	boolean	R	R	N	always "false" (0)	
	out_of_service	boolean	R	R	N	always "false" (0)	
	buzzer.out1 to out3	object_identifier		R	C	N	For Buzzer, Modbus address * 256 + 24, For Out1, Modbus address * 256 + 25, For Out2, Modbus address * 256 + 26, For Out3, Modbus address * 256 + 27
		object_type	enumerated	R	C	N	binary_value (5)
		event_state	enumerated	R	C	N	normal (0)
		object_name	character string	R	N	N	"VA301EM GGGG AdXXX.buzz" "VA301EM GGGG AdXXX.out1" "VA301EM GGGG AdXXX.out2" "VA301EM GGGG AdXXX.out3" where GGGG is the gas name, and XXX is the Modbus address.
		out_of_service	boolean	R	C	N	FALSE
		polarity	enumerated	R	C	N	always Normal (0)
		present_value	enumerated	R	R	N	state of buzzer and three 24VDC outputs.
reliability		enumerated	0	C	N	not meaningful.	
relinquish_default			R	C	N	not meaningful.	
status_flags							
in_alarm	boolean	R	C	N	not meaningful.		
fault	boolean	R	C	N	not meaningful.		
overridden	boolean	R	C	N	always "false" (0)		
out_of_service	boolean	R	C	N	always "false" (0)		
Notes							
1 --						'R' indicates that this property is required by ASHRAE Standard 135 'O' indicates that the property is optional in ASHRAE Standard 135	
2 --						'C' indicates the property is hard-coded as a constant 'N' indicates the property is stored in non-volatile memory 'R' indicate the property is computed constantly and stored in RAM.	

EC-FX

Group	Property	Data Type	Required ¹	Storage Type ²	BACnet Writeable?	Value
Analog Input	object_identifier		R	C	N	Modbus address * 256 + 1. For example an EC-F9 at Modbus address 003 will appear as 769 or 0x0301.
	object_type	enumerated	R	C	N	analog_input (0)
	event_state	enumerated	R	R	N	If gas sensor fault Fault (1), else normal (0)
	object_name	character string	R	N	N	"EC-F9 GGGG AdXXX.GGGG" where GGGG is the gas name and XXX is the Modbus address. The gas name is often "NH3".
	out_of_service	boolean	R	R	N	FALSE
	present_value	real	R	R	N	Gas reading
	reliability	enumerated	O	R	N	As appropriate reports no_fault_detected (0) or unreliable other (7) Fault is detected within 60 seconds
	status_flags					
	in_alarm	boolean	R	R	N	If faulty "true" (1) else "false" (0)
	fault	boolean	R	R	N	If faulty "true" (1) else "false" (0)
	overridden	boolean	R	R	N	"false" (0)
	out_of_service	boolean	R	R	N	"false" (0)
	units	enumerated	R	N	N	Usually ppm (96)
	Amin	object_identifier		R	N	N
object_type		enumerated	R	C	N	analog_value (2)
event_state		enumerated	R	C	N	normal (0)
object_name		character string	R	N	N	"EC-F9 GGGG AdXXX.Amin" where GGGG is the gas name and XXX is the Modbus address. The gas name is often "NH3".
out_of_service		boolean	R	C	N	FALSE
present_value		real	R	N	Y	Gas threshold. Synchronization is maintained with the 301C and the EC-F9. Whichever value is written last is distributed to the other two locations.
reliability		enumerated	O	C	N	no_fault_detected (0)
status_flags						
in_alarm		boolean	R	C	N	always false (0)
fault		boolean	R	C	N	always false (0)
overridden		boolean	R	C	N	always false (0)
out_of_service		boolean	R	C	N	always false (0)
units		enumerated	R	C	N	Usually ppm (96)
Amax		object_identifier		R	N	N
	object_type	enumerated	R	C	N	analog_value (2)
	event_state	enumerated	R	C	N	normal (0)
	object_name	character string	R	N	N	"EC-F9 GGGG AdXXX.Amax" where GGGG is the gas name and XXX is the Modbus address. The gas name is often "NH3".
	out_of_service	boolean	R	C	N	FALSE
	present_value	real	R	N	Y	Gas threshold. Synchronization is maintained with the 301C and the EC-F9. Whichever value is written last is distributed to the other two locations.
	reliability	enumerated	O	C	N	no_fault_detected (0)
	status_flags					
	in_alarm	boolean	R	C	N	always false (0)
	fault	boolean	R	C	N	always false (0)
	overridden	boolean	R	C	N	always false (0)
	out_of_service	boolean	R	C	N	always false (0)
	units	enumerated	R	C	N	Usually ppm (96)
	Notes					
	1 --	"R" indicates that this property is required by ASHRAE Standard 135 "O" indicates that the property is optional in ASHRAE Standard 135				
	2 --	"C" indicates the property is hard-coded as a constant "N" indicates the property is stored in non-volatile memory "R" indicate the property is computed constantly and stored in RAM.				

continued...

EC-FX (suite)

Group	Property	Data Type	Required ¹	Storage Type ²	BACnet Writeable?	Value	
Analog Values	Bmin	object_identifier	R	N	N	Modbus address * 256 + 4. For example an EC-F9 at Modbus address 003 will appear as 772 or 0x0304.	
		object_type	enumerated	R	C	N	analog_value (2)
		event_state	enumerated	R	C	N	normal (0)
		object_name	character string	R	N	N	"EC-F9 GGGG AdXXX_Bmin" where GGGG is the gas name and XXX is the Modbus address. The gas name is often "NH3".
		out_of_service	boolean	R	C	N	FALSE
		present_value	real	R	N	Y	Gas threshold. Synchronization is maintained with the 301C and the EC-F9. Whichever value is written last is distributed to the other two locations.
		reliability	enumerated	O	C	N	no_fault_detected (0)
		status_flags					
		in_alarm	boolean	R	C	N	always false (0)
	fault	boolean	R	C	N	always false (0)	
	overridden	boolean	R	C	N	always false (0)	
	out_of_service	boolean	R	C	N	always false (0)	
	units	enumerated	R	C	N	Usually ppm (96)	
	Bmax	object_identifier		R	N	N	Modbus address * 256 + 5. For example an EC-F9 at Modbus address 003 will appear as 773 or 0x0305.
		object_type	enumerated	R	C	N	analog_value (2)
		event_state	enumerated	R	C	N	normal (0)
		object_name	character string	R	N	N	"EC-F9 GGGG AdXXX_Bmax" where GGGG is the gas name and XXX is the Modbus address. The gas name is often "NH3".
		out_of_service	boolean	R	C	N	FALSE
		present_value	real	R	N	Y	Gas threshold. Synchronization is maintained with the 301C and the EC-F9. Whichever value is written last is distributed to the other two locations.
reliability		enumerated	O	C	N	no_fault_detected (0)	
status_flags							
in_alarm		boolean	R	C	N	always false (0)	
fault	boolean	R	C	N	always false (0)		
overridden	boolean	R	C	N	always false (0)		
out_of_service	boolean	R	C	N	always false (0)		
units	enumerated	R	C	N	Usually ppm (96)		
Notes							
	1 --	'R' indicates that this property is required by ASHRAE Standard 135					
		'O' indicates that the property is optional in ASHRAE Standard 135					
	2 --	'C' indicates the property is hard-coded as a constant					
		'N' indicates the property is stored in non-volatile memory					
		'R' indicate the property is computed constantly and stored in RAM.					
						continued...	

EC-FX (suite)

Group	Property	Data Type	Required ¹	Storage Type ²	BACnet Writeable?	Value	
Analog Values	Cmin	object_identifier	R	N	N	Modbus address * 256 + 6. For example an EC-F9 at Modbus address 003 will appear as 774 or 0x0306.	
		object_type	enumerated	R	C	N	analog_value (2)
		event_state	enumerated	R	C	N	normal (0)
		object_name	character string	R	N	N	"EC-F9 GGGG AdXXX.Cmin" where GGGG is the gas name and XXX is the Modbus address. The gas name is often "NH3".
		out_of_service	boolean	R	C	N	FALSE
		present_value	real	R	N	Y	Gas threshold. Synchronization is maintained with the 301C and the EC-F9. Whichever value is written last is distributed to the other two locations.
		reliability	enumerated	O	C	N	no_fault_detected (0)
		status_flags					
		in_alarm	boolean	R	C	N	always false (0)
		fault	boolean	R	C	N	always false (0)
	overridden	boolean	R	C	N	always false (0)	
	out_of_service	boolean	R	C	N	always false (0)	
	units	enumerated	R	C	N	Usually ppm (96)	
	Cmax	object_identifier		R	N	N	Modbus address * 256 + 7. For example an EC-F9 at Modbus address 003 will appear as 775 or 0x0307.
		object_type	enumerated	R	C	N	analog_value (2)
		event_state	enumerated	R	C	N	normal (0)
		object_name	character string	R	N	N	"EC-F9 GGGG AdXXX.Cmax" where GGGG is the gas name and XXX is the Modbus address. The gas name is often "NH3".
		out_of_service	boolean	R	C	N	FALSE
		present_value	real	R	N	Y	Gas threshold. Synchronization is maintained with the 301C and the EC-F9. Whichever value is written last is distributed to the other two locations.
reliability		enumerated	O	C	N	no_fault_detected (0)	
status_flags							
in_alarm		boolean	R	C	N	always false (0)	
fault		boolean	R	C	N	always false (0)	
overridden	boolean	R	C	N	always false (0)		
out_of_service	boolean	R	C	N	always false (0)		
units	enumerated	R	C	N	Usually ppm (96)		
Notes							
	1 --	'R' indicates that this property is required by ASHRAE Standard 135					
		'O' indicates that the property is optional in ASHRAE Standard 135					
	2 --	'C' indicates the property is hard-coded as a constant					
		'N' indicates the property is stored in non-volatile memory					
		'R' indicate the property is computed constantly and stored in RAM.					

420MDBS_IR-F9

Group	Property	Data Type	Required ¹	Storage Type ²	BACnet Writeable?	Value	
analog_in gas	object_identifier		R	C	N	Modbus address * 256 + 1. For example an 420MDBS at Modbus address 002 will appear as 513 or 0x0201.	
	object_type	enumerated	R	C	N	analog_input (0)	
	event_state	enumerated	R	R	N	if gas sensor fault Fault (1), else normal (0)	
	object_name	character string	R	N	N	"420MDBS GGGG AdXXX.GGGG" where GGGG is the gas name and XXX is the Modbus address. Values for gas name include "NH3".	
	out_of_service	boolean	R	R	N	FALSE	
	present_value	real	R	R	N	Gas reading	
	reliability	enumerated	O	R	N	As appropriate reports no_fault_detected (0) or unreliable other (7)	
	status_flags						
		in_alarm	boolean	R	R	N	if alarm or fault "true" (1) else "false" (0)
		fault	boolean	R	R	N	if faulty "true" (1) else "false" (0)
		overridden	boolean	R	R	N	"false" (0)
		out_of_service	boolean	R	R	N	"false" (0)
		units	enumerated	R	N	N	Depends on configuration of 420MDBS factory configuration or 301C configuration, usually ppm (96)
	Notes						
	1 --	'R' indicates that this property is required by ASHRAE Standard 135					
		'O' indicates that the property is optional in ASHRAE Standard 135					
	2 --	'C' indicates the property is hard-coded as a constant					
		'N' indicates the property is stored in non-volatile memory					
		'R' indicate the property is computed constantly and stored in RAM.					

continued...

420MDBS_IR-F9 (suite)

Group	Property	Data Type	Required ¹	Storage Type ²	BACnet Writeable?	Value	
Analog Values	Amin	object_identifier	R	N	N	Modbus address * 256 + 2. For example an 420MDBS at Modbus address 002 will appear as 514 or 0x0202.	
		object_type	enumerated	R	C	N	analog_value (2)
		event_state	enumerated	R	C	N	normal (0)
		object_name	character string	R	N	N	"420MDBS GGGG AdXXX.Amin" where GGGG is the gas name and XXX is the Modbus address. Values for gas name include "NH3".
		out_of_service	boolean	R	C	N	FALSE
		present_value	real	R	N	Y	Gas threshold from 301C. Synchronization is maintained with the 301C and the 420MDBS. Whichever value is written last is distributed to the other two locations.
		reliability	enumerated	O	C	N	no_fault_detected (0)
		status_flags					
		in_alarm	boolean	R	C	N	always false (0)
		fault	boolean	R	C	N	always false (0)
	overridden	boolean	R	C	N	always false (0)	
	out_of_service	boolean	R	C	N	always false (0)	
	units	enumerated	R	C	N	Depends on configuration of 420MDBS factory configuration or 301C configuration, usually ppm (96)	
	Amax	object_identifier		R	N	N	Modbus address * 256 + 3. For example an 420MDBS at Modbus address 002 will appear as 515 or 0x0203.
		object_type	enumerated	R	C	N	analog_value (2)
		event_state	enumerated	R	C	N	normal (0)
		object_name	character string	R	N	N	"420MDBS GGGG AdXXX.Amin" where GGGG is the gas name and XXX is the Modbus address. Values for gas name include "NH3".
		out_of_service	boolean	R	C	N	FALSE
		present_value	real	R	N	Y	Gas threshold from 301C. Synchronization is maintained with the 301C and the 420MDBS. Whichever value is written last is distributed to the other two locations.
		reliability	enumerated	O	C	N	no_fault_detected (0)
status_flags							
in_alarm		boolean	R	C	N	always false (0)	
fault		boolean	R	C	N	always false (0)	
overridden	boolean	R	C	N	always false (0)		
out_of_service	boolean	R	C	N	always false (0)		
units	enumerated	R	C	N	Depends on configuration of 420MDBS factory configuration or 301C configuration, usually ppm (96)		
Notes							
1 --	'R' indicates that this property is required by ASHRAE Standard 135						
	'O' indicates that the property is optional in ASHRAE Standard 135						
2 --	'C' indicates the property is hard-coded as a constant						
	'N' indicates the property is stored in non-volatile memory						
	'R' indicate the property is computed constantly and stored in RAM.						
						continued...	

420MDBS_IR-F9 (suite)

Group	Property	Data Type	Required ¹	Storage Type ²	BACnet Writeable?	Value	
Analog Values	Bmin	object_identifier	R	N	N	Modbus address * 256 + 4. For example an 420MDBS at Modbus address 002 will appear as 516 or 0x0204.	
		object_type	enumerated	R	C	N	analog_value (2)
		event_state	enumerated	R	C	N	normal (0)
		object_name	character string	R	N	N	"420MDBS GGGG AdXXX.Amin" where GGGG is the gas name and XXX is the Modbus address. Values for gas name include "NH3".
		out_of_service	boolean	R	C	N	FALSE
		present_value	real	R	N	Y	Gas threshold from 301C. Synchronization is maintained with the 301C and the 420MDBS. Whichever value is written last is distributed to the other two locations.
		reliability	enumerated	O	C	N	no_fault_detected (0)
		status_flags					
		in_alarm	boolean	R	C	N	always false (0)
	fault	boolean	R	C	N	always false (0)	
	overridden	boolean	R	C	N	always false (0)	
	out_of_service	boolean	R	C	N	always false (0)	
	units	enumerated	R	C	N	Depends on configuration of 420MDBS factory configuration or 301C configuration, usually ppm (96)	
	Bmax	object_identifier		R	N	N	Modbus address * 256 + 5. For example an 420MDBS at Modbus address 002 will appear as 517 or 0x0205.
		object_type	enumerated	R	C	N	analog_value (2)
		event_state	enumerated	R	C	N	normal (0)
		object_name	character string	R	N	N	"420MDBS GGGG AdXXX.Amin" where GGGG is the gas name and XXX is the Modbus address. Values for gas name include "NH3".
		out_of_service	boolean	R	C	N	FALSE
present_value		real	R	N	Y	Gas threshold from 301C. Synchronization is maintained with the 301C and the 420MDBS. Whichever value is written last is distributed to the other two locations.	
reliability		enumerated	O	C	N	no_fault_detected (0)	
status_flags							
in_alarm		boolean	R	C	N	always false (0)	
fault	boolean	R	C	N	always false (0)		
overridden	boolean	R	C	N	always false (0)		
out_of_service	boolean	R	C	N	always false (0)		
units	enumerated	R	C	N	Depends on configuration of 420MDBS factory configuration or 301C configuration, usually ppm (96)		
Notes							
1 --	'R' indicates that this property is required by ASHRAE Standard 135						
	'O' indicates that the property is optional in ASHRAE Standard 135						
2 --	'C' indicates the property is hard-coded as a constant						
	'N' indicates the property is stored in non-volatile memory						
	'R' indicate the property is computed constantly and stored in RAM.						

301ADI

Group	Property	Data Type	Required ¹	Storage Type ²	BACnet Writeable?	Value
analog_inputs (Up to 16 if configured enabled on the 301ADI user interface.)	object_identifier		R	C	N	(Modbus address+channel number) * 256 - 255, where channel number is 1 to 16. For example analog input 7 from a 301ADI at address 097 will appear as 26369 or 0x6107.
	object_type	enumerated	R	C	N	analog_input (0)
	event_state	enumerated	R	R	N	not meaningful.
	object_name	character string	R	N	N	"VA301ADI AI.CC AdXXX.AI.CC" where CC is the channel number from 1 to 16 and XXX is the Modbus address.
	out_of_service	boolean	R	R	N	FALSE
	present_value	real	R	R	N	Reading from 301C, mA by default. Scaling in the 301C is supported.
	reliability	enumerated	O	R	N	not meaningful.
	status_flags					
	in_alarm	boolean	R	R	N	not meaningful.
	fault	boolean	R	R	N	"false" (0)
	overridden	boolean	R	R	N	"false" (0)
	out_of_service	boolean	R	R	N	"false" (0)
	units	enumerated	R	N	N	mA (02) by default. Reconfiguration in the 301C is possible. New units may not propagate until a power cycle.
	Binary Inputs (up to 8) (Up to 8 if configured enabled on the 301ADI user interface.)	object_identifier		R	N	N
object_type		enumerated	R	C	N	binary_input (3)
event_state		enumerated	R	C	N	normal (0)
object_name		character string	R	N	N	"VA301ADI BI.CC AdXXX.BI.CC" where CC is the channel number from 1 to 16 and XXX is the Modbus address plus the channel number plus 15.
out_of_service		boolean	R	C	N	FALSE
present_value		real	R	N	N	0 if input is an open circuit, 1 if input is shorted to VDC out
reliability		enumerated	O	C	N	no_fault_detected (0)
status_flags						
in_alarm		boolean	R	C	N	always false (0)
fault		boolean	R	C	N	always false (0)
overridden		boolean	R	C	N	always false (0)
out_of_service		boolean	R	C	N	always false (0)
polarity		boolean	R	C	N	always 0
active_text		character string	O	C	N	"ON"
	Notes					
	1 --					'R' indicates that this property is required by ASHRAE Standard 135 'O' indicates that the property is optional in ASHRAE Standard 135
	2 --					'C' indicates the property is hard-coded as a constant 'N' indicates the property is stored in non-volatile memory 'R' indicate the property is computed constantly and stored in RAM.

301R

Group	Property	Data Type	Required ¹	Storage Type ²	BACnet Writeable?	Value
Binary Outputs rel1 to rel8	object_identifier		R	C	N	RelayNumber + Modbus address * 256 + 7. For example Relay 4 in a 301R at Modbus address 095 will appear as 24331 or 0x5F0B.
	object_type	enumerated	R	C	N	binary_output (4)
	event_state	enumerated	R	C	N	normal (0)
	object_name	character string	R	N	N	"VA301R AdXXX.relR" where XXX is the Modbus address and R is the relay number.
	out_of_service	boolean	R	C	N	FALSE
	polarity	enumerated	R	C	N	always Normal (0)
	present_value	enumerated	R	R	Only Rly 1to4. Not Rly 5to8.	True state of the relays. These take the value of the highest-priority BACnet command. If no BACnet command, this takes the value of the associated event.
	priority_array		R	R	N	last value written
	reliability	enumerated	0	C	N	no_fault_detected (0)
	relinquish_default		R	C	N	not meaningful
	active_text	character string	O	C	N	"ON"
	status_flags					
	in_alarm	boolean	R	C	N	always "false" (0)
	fault	boolean	R	C	N	always "false" (0)
	overridden	boolean	R	R	N	always "false" (0)
	out_of_service	boolean	R	R	N	always "false" (0)
Notes						
1 --	'R' indicates that this property is required by ASHRAE Standard 135					
	'O' indicates that the property is optional in ASHRAE Standard 135					
2 --	'C' indicates the property is hard-coded as a constant					
	'N' indicates the property is stored in non-volatile memory					
	'R' indicate the property is computed constantly and stored in RAM.					

Déclaration de conformité de mise en œuvre des protocoles
(conforme aux normes en vigueur)

Déclaration de conformité d'implémentation du protocole BACnet

BACnet Protocol Implementation Conformance Statement

Date : August 1, 2005

Vendor Name : Honeywell Analytics

Product Name : 301C -BIP

Product Model Number: N/A

Applications Software Version : 1.0

Firmware Revision : 1.0

BACnet Protocol Revision : 1.0

Product Description:

The 301C -BIP has a module that uses BACnet communication. As such, the components of a Vulcain network can be connected to a BACnet network via the 301C controller.

BACnet Standardized Device Profile (Annex L)

- BACnet Operator Workstation (B-OWS)_
- BACnet Building Controller (B-BC)
- BACnet Advanced Application Controller (B-AAC)_
- BACnet Application Specific Controller (B-ASC)
- BACnet Smart Sensor (B-SS)
- BACnet Smart Actuator (B-SA)

List all BACnet Interoperability Building Blocks Supported (Annex K)

Data Sharing

- Data Sharing-ReadProperty-A (DS-RP-A)
- Data Sharing-ReadProperty-B (DS-RP-B)
- Data Sharing-ReadPropertyMultiple-A (DS-RPM-A)
- Data Sharing-ReadPropertyMultiple-B (DS-RPM-B)
- Data Sharing-ReadPropertyConditional-A (DS-RPC-A)
- Data Sharing-ReadPropertyConditional-B (DS-RPC-B)
- Data Sharing-WriteProperty-A (DS-WP-A)
- Data Sharing-WriteProperty-B (DS-WP-B)
- Data Sharing-WritePropertyMultiple-A (DS-WPM-A)
- Data Sharing-WritePropertyMultiple-B (DS-WPM-B)
- Data Sharing-COV-A (DS-COV-A)
- Data Sharing-COV-B (DS-COV-B)
- Data Sharing-COVP-A (DS-COVP-A)
- Data Sharing-COVP-B (DS-COVP-B)
- Data Sharing-COV-Unsolicited-A (DS-COVU-A)
- Data Sharing-COV-Unsolicited-B (DS-COVU-B)

Scheduling

- Scheduling-A (SCHED-A)
- Scheduling-Internal-B (SCHED-I-B)
- Scheduling-External-A (SCHED-E-B)

Trending

- Viewing and Modifying Trends-A (T-VMT-A)
- Trending-Viewing and Modifying Trends-Internal-B (T-VMT-I-B)
- Trending-Viewing and Modifying Trends-External-B (T-VMT-E-B)
- Trending-Automated Trend Retrieval-A (T-ATR-A)
- Trending-Automated Trend Retrieval-B (T-ATR-B)

Network Management

- Network Management-Connection Establishment-A (NM-CE-A)
- Network Management-Connection Establishment-B (NM-CE-B)
- Network Management-Router Configuration-A (NM-RC-A)
- Network Management-Router Configuration-B (NM-RC-B)

Alarm and Event Management

- Alarm and Event-Notification-A (AE-N-A)
- Alarm and Event-Notification Internal-B (AE-N-I-B)
- Alarm and Event-Notification External-A (AE-N-E-B)
- Alarm and Event-ACK-A (AE-ACK-A)
- Alarm and Event-ACK-B (AE-ACK-B)
- Alarm and Event-Alarm Summary-A (AE-ASUM-A)
- Alarm and Event-Alarm Summary-B (AE-ASUM-B)
- Alarm and Event-Enrollment Summary-A (AE-ESUM-A)
- Alarm and Event-Enrollment Summary-B (AE-ESUM-B)
- Alarm and Event-Information-A (AE-INFO-A)
- Alarm and Event-Information-B (AE-INFO-B)
- Alarm and Event-LifeSafety-A (AE-LS-A)
- Alarm and Event-LifeSafety-B (AE-LS-B)

Device Management

- Device Management-Dynamic Device Binding-A (DM-DDB-A)
- Device Management-Dynamic Device Binding-B (DM-DDB-B)
- Device Management-Dynamic Object Binding-A (DM-DOB-A)
- Device Management-Dynamic Object Binding-B (DM-DOB-B)
- Device Management-DeviceCommunicationControl-A (DM-DCC-A)
- Device Management-DeviceCommunicationControl-B (DM-DCC-B)
- Device Management-Private Transfer-A (DM-PT-A)
- Device Management-Private Transfer-B (DM-PT-B)
- Device Management-Text Message-A (DM-TM-A)
- Device Management-Text Message-B (DM-TM-B)
- Device Management-TimeSynchronization-A (DM-TS-A)
- Device Management-TimeSynchronization-B (DM-TS-B)
- Device Management-UTCTimeSynchronization-A (DM-UTC-A)
- Device Management-UTCTimeSynchronization-B (DM-UTC-B)

- Device Management-ReinitializeDevice-A (DM-RD-A)
- Device Management-ReinitializeDevice-B (DM-RD-B)
- Device Management-Backup and Restore-A (DM-BR-A)
- Device Management-Backup and Restore-B (DM-BR-B)
- Device Management-List Manipulation-A (DM-LM-A)
- Device Management-List Manipulation-B (DM-LM-B)
- Device Management-Object Creation and Deletion-A (DM-OCD-A)
- Device Management-Object Creation and Deletion-B (DM-OCD-B)
- Device Management-Virtual Terminal-A (DM-VT-A)
- Device Management-Virtual Terminal-B (DM-VT-B)

Segmentation Capability :

- Segmented requests supported Window Size

- Segmented responses supported Window Size : Take maximum
Windows size supported by the other device

Standard Object Types Supported :

Analog Input	For all objects
Analog Output	1) cannot be dynamically createable using Create Object service
Analog Value	2) cannot be dynamically deletable using DeleteObject service
Binary Input	3) No additional writable properties exist
Binary Output	4) No proprietary properties exist
Binary Value	5) No range restriction
Device	

Data Link Layer Options

- BACnet IP, (Annex J)
- BACnet IP, (Annex J), Foreign Device
- ISO 8802-3, Ethernet (Clause 7)

- ANSI/ATA 878.1, 2.5 Mb. ARCNET (Clause 8)
- ANSI/ATA 878.1, RS-485 ARCNET (Clause 8), baud rate(s)
- MS/TP master (Clause 9), baud rate(s):
- MS/TP slave (Clause 9), baud rate(s):
- Point-To-Point, EIA 232 (Clause 10), baud rate(s):
- Point-To-Point, modem, (Clause 10), baud rate(s):
- LonTalk, (Clause 11), medium:
- Other:

Device Address Binding :

Is static device binding supported? (This is currently necessary for two-way communication with MS/TP slaves and certain other devices.)

- Yes No

Networking Options

- Router, BACnet / Modbus.
- Annex H, BACnet Tunneling Router over IP
- BACnet/IP Broadcast Management Device (BBMD)

Does the BBMD support registrations by Foreign Devices?

- Yes No

Character Sets Supported

Indicating support for multiple character sets does not imply that they can all be supported simultaneously.

- ANSI X3.4 IBM™/Microsoft™ DBCS
- ISO 8859-1
- ISO 10646 (UCS-2) ISO 10646 (UCS-4)
- JIS C 6226

If this product is a communication gateway, describe the types of non-BACnet equipment/networks(s) that the gateway supports :
none

10. Reseau sans-fil

Non pris en charge.

Spécifications

Alimentation requise pour le 301C	17-27 VCA, 50/60 Hz, 8,64 VA 18-36 VCC, 350 mA à 24 VCC (8,4 VA)
Plage de température de fonctionnement	-20 °C à 50 °C (-4 °F à 122 F)
Plage d'humidité en fonctionnement	0 à 95 % HR (sans condensation)
Altitude de fonctionnement	Jusqu'à 3 000 m (9 843 pi)
Capacité du réseau	Jusqu'à 96 émetteurs, 32 par canal Canaux 1, 2 = Modbus et Vulbus Canal 3 = Modbus seulement
Communication	Jusqu'à 609 m (2 000 pi) par canal
Interface utilisateur	Ecran matriciel rétroéclairé 122 x 32 points Clavier utilisateur convivial
Indicateurs visuels	Alimentation Voyant DEL vert Alarme A, B, C Voyant DEL rouge Anomalie Voyant DEL orange Émetteur Voyant DEL orange Récepteur Voyant DEL vert
Sorties	4 relais DPDT
Sortie nominale	5 A, 30 VCC ou 250 VCA (charge résistive)
Alarme sonore	65 dBA à 1 m (3 pi)
Délais	Délais Avant et Après programmables
Pile	Pile au lithium 3 V
Boîtier	ABS-polycarbonate – Utilisation en intérieur
Dimensions (H x l x P)	28 x 20,3 x 7 cm (7,99 x 11,02 x 2,76 po)
Homologations	ANSI/UL 61010-1 CAN/CSA C22.2 N° 61010-1 ETL 116662

Garantie limitée

Garantie limitée

Honeywell Analytics, Inc. garantit à l'acheteur d'origine et/ou au client final, (« Acheteur ») des produits Vulcain (« Produit ») qu'en cas de vice de matériau ou de fabrication constaté sur une pièce du produit dans les douze (12) mois suivant l'achat, cette pièce sera réparée ou remplacée gratuitement, à la discrétion de Honeywell Analytics, à condition qu'elle ait été retournée en port prépayé à Honeywell Analytics au 3580 Rue Isabelle Unit 100 Brossard, Quebec, Canada J4Y 2R3, ou 405 Barclay Blvd, Lincolnshire IL 60069 USA, dans son emballage d'origine ou un emballage équivalent. Le Produit sera renvoyé en fret prépayé et réparé ou remplacé s'il est déterminé par Honeywell Analytics que la défaillance de la pièce est due à un vice de matériau ou de fabrication. La réparation ou le remplacement de cette pièce défectueuse constitue la seule responsabilité et obligation de Honeywell Analytics dans le cadre de cette garantie limitée.

Politique de retour

Les frais de restockage suivants s'appliqueront lorsque les clients retournent les produits à des fins de crédit :

- Des frais de retour de 15 % seront appliqués si le Produit est retourné dans le **1er mois** suivant sa date d'expédition.
- Des frais de retour de 30 % seront appliqués si le Produit est retourné dans les **3 mois** suivant sa date d'expédition.

Un crédit complet (moins frais de restockage) ne sera attribué que si le produit est en parfait état de fonctionnement. Si des réparations sont nécessaires sur le Produit retourné, les frais de ces réparations seront déduits du crédit.

Aucun crédit ne sera accordé pour un Produit retourné après trois mois suivant sa date d'expédition.

Exclusions

A. Si les capteurs de gaz font partie du produit, le détecteur de gaz est couvert par une garantie limitée de douze (12) mois du fabricant.

B. Si des capteurs de gaz sont couverts par cette garantie limitée, le capteur est assujéti à l'inspection par Honeywell Analytics pour l'exposition prolongée à des concentrations de gaz élevées si l'Acheteur fait une réclamation dans le cadre de cette garantie limitée. Si l'inspection indique que la défectuosité est due à l'épuisement du capteur de gaz et non un défaut, ladite garantie ne s'applique pas au Produit.

C. Cette garantie limitée ne couvre pas les consommables tels les piles ou les articles sujets à l'usure ou au remplacement régulier, incluant les lampes, les fusibles, les valves, les aubes, les éléments de sonde, les cartouches ou les éléments de filtre.

Limitation et exclusion de la garantie

Dans le cadre de cette garantie limitée, Honeywell Analytics n'a aucune autre obligation. Toutes les obligations de garantie de Honeywell Analytics sont annulées si le produit a fait l'objet d'usage abusif, de mauvaises utilisations, de négligence ou d'un accident ou si l'acheteur n'a accompli aucune des obligations énoncées dans cette garantie limitée ou si le produit n'a pas été utilisé conformément aux instructions ou si le numéro de série du Produit a été enlevé ou modifié.

Avis de non-responsabilité pour toute autre garantie non déclarée

La garantie mentionnée ci-dessus est la seule garantie applicable dans le cadre de cet achat. Toutes les autres garanties, qu'elles soient implicites ou expresses, incluant, mais sans s'y limiter, les garanties tacites de qualité marchande ou d'aptitude à un usage particulier, sont rejetées par le présent document.

Limitation de responsabilité

Il est entendu et accepté que la responsabilité de Honeywell Analytics, que la cause invoquée soit le contrat, le délit civil, n'importe quelle garantie de responsabilité, la négligence ou autre, n'excédera pas le prix d'achat payé par l'Acheteur pour le Produit. Dans aucun cas, la société Honeywell Analytics ne pourra être tenue responsable pour des dommages spéciaux, indirects ou consécutifs. Le prix indiqué pour le produit est un facteur limitant la responsabilité de Honeywell Analytics. Aucune action, quelle qu'en soit la forme, découlant des transactions dans le cadre de cette garantie, ne peut être entreprise par l'Acheteur plus d'un an après l'occurrence de la cause de ces actions.