

# ADAE

Upgraded version with TWAIN DRIVER

## Refine X-Ray sensor



# Catalogue

|                                  |    |
|----------------------------------|----|
| 1 Preface                        | 1  |
| 2 Spare parts                    | 3  |
| 3 Signs and notices              | 4  |
| 4 Installation and operation     | 5  |
| 5 Software introduction          | 8  |
| 6 Trouble shooting               | 15 |
| 7 Cleaning, disinfection         | 16 |
| 8 Storage and transportation     | 16 |
| 9 After-sales service            | 17 |
| 10 Electromagnetic compatibility | 17 |
| 11 Statement                     | 19 |

## 1 Preface

Before operating, please read this user manual and pay attention to all safety precautions.

Please ensure that this user's manual is properly maintained so that it can be accessed at any time.

Please use it correctly on the basis of full understanding of the content.

### 1.1 Application scope

R1 and R2 dental sensor are used in conjunction with dental radiography in medical units. The product is used for dental X-ray examination, the diagnosis of structural diseases of teeth, jaws and mouth. The product is expected to be used in hospitals and clinics, operated and used by trained professionals under the guidance of doctors.

According to the expected use of R1/R2 and the result of risk assessment, the product essential performance is identified: image acquisition of X-ray sensor and image process.

This manual contains information about R1/R2. All users should read and understand this manual before using the product. All information in this manual, including illustrations, is based on the device prototype. If the device does not contain these contents, they will not apply to this device.

### 1.2 Safety precautions

1.2.1 Do not use or store the equipment near flammable chemicals such as thinner, benzene, etc.

If chemicals are spilled or evaporate, it may result in fire or product damage through contact with electric parts inside the equipment.

Do not connect the equipment with anything other than specified. Doing so may result in personal injury or product damage.

Do not install or use in the following environment, or it may cause fire, personal injury or product damage.

- Facilities near water sources
- In direct sunlight
- Close to air condition or ventilation Dusty to a heat source as a heater
- In a salty or acidic environment High temperature and high humidity Ice or condensation
- In the environment easy to vibrate On a slope or in an unstable area

1.2.2 Ensure that the cable is not knotted or wound during use. Or it may cause the equipment damage or personal injury.

1.2.3 Never disassemble or modify the equipment. No modification of this equipment is allowed.

1.2.4 Follow the below instructions to prevent damage to the sensor and cable:

- Do not twist, bend, pull and pinch the cable strongly
- Do not strike or drop the equipment.

- Do not touch the pin of the USB connector
- Do not put the equipment and pointed objects together.

1.2.5 Please unplug the USB connector when a problem happened and contact the supplier or local dealer:

- When there is smoke, an odd smell or abnormal sound.
- When liquid has been spilled into the equipment or a metal object has entered through an opening.
- When the equipment has been dropped and damaged.

### 1.3 Notes for Using

When using the equipment, take the following precautions. Otherwise, problems may occur and the equipment may not function correctly.

#### Before using

- Please check whether the USB connector is dry or clean before connecting the USB connector
- Please hold the control box of the USB when plugging the USB connector, do not touch the pin of USB connector

#### During using

- Do not move the USB connector during the use of the sensor
- When the sensor is working, the temperature of the sensor will increase. Please pay attention to the temperature of the sensor to avoid the risk of injury.
- The detector should warm up for 15 minutes before exposure or updating the gain map or defect map.

#### During exposure

- Do not move the Cable or Sensor during exposure, or it may cause image noise or artifacts, even incorrect images.
- Do not use the devices near the equipment generating a strong magnetic field. Otherwise, it may cause image noise, artifacts or even incorrect images.

#### After using







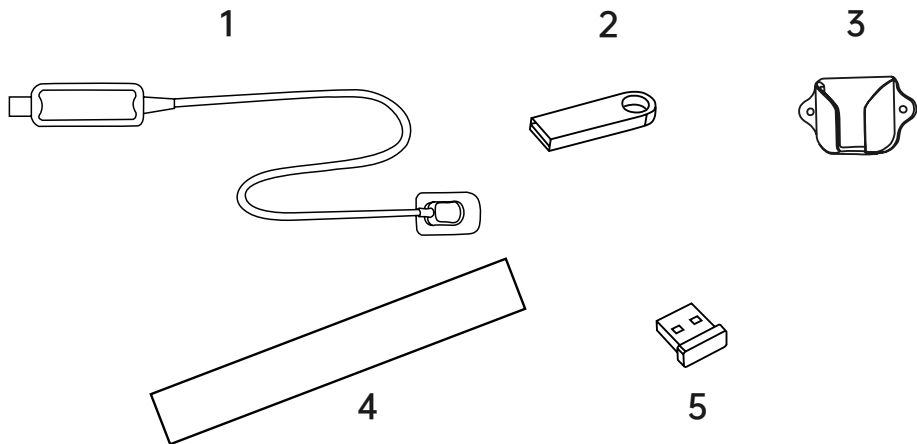

- After the USB port is pulled out, please take care of the USB connector to avoid the risk of damage.
- The sensor should be stored in a place free of chemicals or gases and free from adverse factors such as pressure, high temperature, humidity, direct sunlight, dust, oxides or sulfides.

## 2 Spare parts

1. Sensor
2. USB flash disk (Software)
3. Sensor holder
4. Protective sleeve
5. Dongle

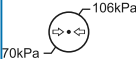

### 3 Symbol instruction

| Symbol  | Instruction                  | Symbol  | Instruction                                   |
|---|------------------------------|---|---|
|  | Date of manufacture          |  | Manufacturer                                  |
|  | Serial number                |  | Type BF applied part                          |
|  | Keep dry                     |  | Temperature limit: -20°C- +40°C               |
|  | Humidity limitation: 10%-93% |  | Atmospheric pressure limitation: 70kPa-106kPa |
|  | Recovery                     |  | Waste electrical and electronic equipment     |

## 4 Installation and operation

### 4.1 Hardware and software requirement

|                    |                    |
|--------------------|--------------------|
| Processor          | 1.0GHz or above    |
| Memory             | 2GB or above       |
| Hard disk          | 64GB or above      |
| Display resolution | 1024*768 or above  |
| USB port           | USB2.0             |
| Operating system   | Windows 7 or above |

### 4.2 Installation

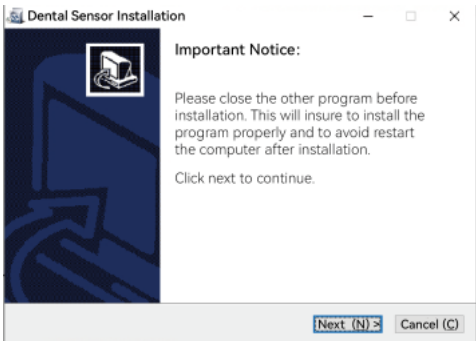
|   |  |
|---|--|
| <p>Step 1: Plug in the USB flash disk, then double click the "run" file</p> |   |
| <p>Step 2: Click "Next" to start installation</p>                           |  |

Step 3: Select the installation location, click "Review" to change the installation location or directly click "Next" to continue

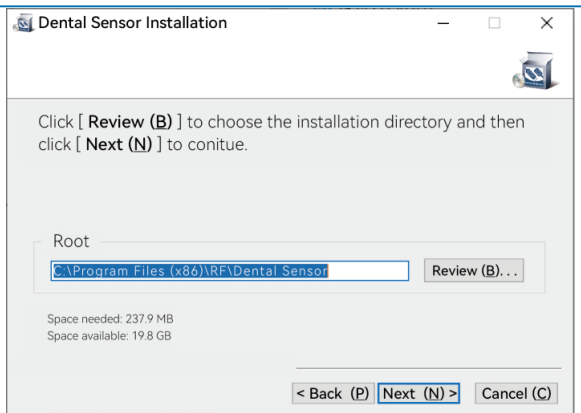

Step 4: If there's only one device, you may select "Single-User" installation. If the sensor is connected to multiple device, select "Host" for the device connected with the sensor and other devices select "Extension" to install, then click Next to continue

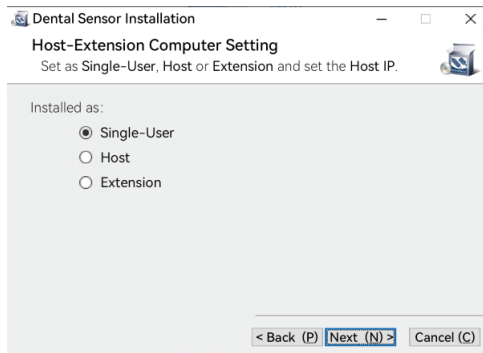



Step 5: Plug in the sensor and the dongle, then click "Finish" to finalize the installation

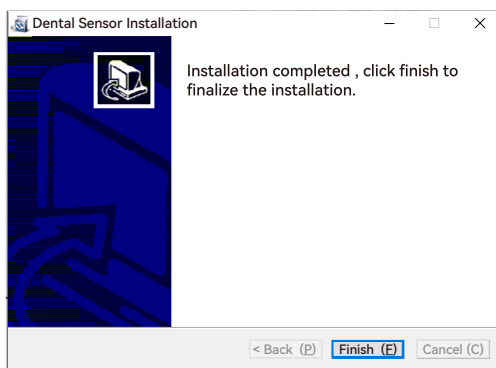

**Note 1:** When choosing the "Extension", you need to enter the IP address of the host computer, and then click "Next" to continue.

**Note 2:** The dongle should always be connected to the device when using the sensor, otherwise you can only shoot 50 images.

#### 4.3 Fix the sensor holder on the right place

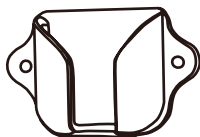

## 5 Software introduction



5.1 Input User and Password, then click confirm to start the software:

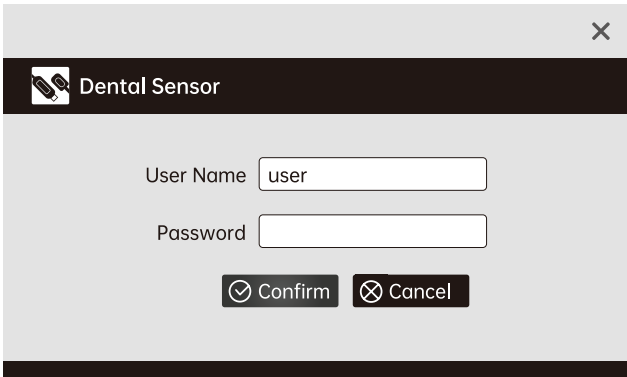



|   |                          |
|---|--------------------------|
|  A screenshot of a software dialog box titled "Dental Sensor". It contains two input fields: "User Name" with the text "user" and "Password" which is empty. Below the fields are two buttons: "Confirm" with a checkmark icon and "Cancel" with an 'X' icon. The dialog box has a close button (X) in the top right corner. |                          |
| USER  | user                     |
| Password  | Default password: 123456 |

## 5.2 Pages introduction

### 5.2.1 Operating page

The screenshot displays the operating page interface with the following numbered callouts:

- 1: Patient management icon
- 2: New patient icon
- 3: Exposure icon
- 4: Save icon
- 5: Image export icon
- 6: Image import icon
- 7: Settings icon
- 8: Grid icon
- 9: Full screen icon
- 10: Refresh icon
- 11: Close icon
- 12: User profile icon
- 13: Patient selection dropdown
- 14: X-ray image
- 15: Procedure selection icons
- 16: Contrast slider
- 17: Brightness slider
- 18: Filter icon
- 19-22: View icons (top row)
- 23-25: View icons (middle row)
- 26-29: Tool icons (bottom row)
- 30-31: Additional tool icons

|   |   |   |   |
|---|---|---|---|
| ① |  Patient management                                | ② |  New patient                                       |
| ③ |  Exposure  | ④ |  Save  |
| ⑤ |  Image export: Image can be DCM, JPG or PNG format | ⑥ |  Image import: Image can be DCM, JPG or PNG format |

|   |   |   |  |
|---|---|---|--|
| ⑦   | Image delete  | ⑧   | Report print: Prints a report of the current patient             |
| ⑨  | Full screen   | ⑩  | View: To view or compare 2 or 4 images at the same time          |
| ⑪  | Setting   | ⑫   | Patient's name   |
| ⑬   | Image list  | ⑭   | Image checking   |
| ⑮   | Teeth Position  | ⑯  | Contrast   |
| ⑰  | Brightness  | ⑱  | Gamma  |
| ⑲  | Negative: Image show the effect of the negative                                       | ⑳  | Denoising: Remove spots on the image                             |
| ㉑  | Sharpen: Highlight the edge of the image  | ㉒  | Pseudocolor  |
| ㉓  | Periodontal: More clearly to check the decayed teeth                                  | ㉔  | Crown: More clearly to observe the crown                         |
| ㉕  | Endodontic: More clearly to observe the root  | ㉖  | Rotate 90°clockwise  |
| ㉗  | Flip horizontally   | ㉘  | Flip vertically  |
| ㉙  | Zoom up   | ㉚  | Distance: Measure the length between any two points on the image |
| ㉛  | Angle: Select three points on the image to measure the angle between the three points | ㉜  | Pencil   |
| ㉝  | Revert  | ㉞  | Undo   |
| ㉟  | Redo  | ㉟  | Edit   |
| ㊱  | Save  |   |  |

## 5.2.2 Patients management

The screenshot shows a window titled "Patient Management" with a search bar and a "Delete all" button. Below is a table with columns: Surname, First name, Patient No., Dentist, Gender, Date of Birth, and Phone. One row is visible with the following data: Surname: 秦, First name: 雯雯, Patient No.: (empty), Dentist: 卢仁麟, Gender: Male, Date of Birth: 10/29/2021, Phone: (empty). To the right of the table is a vertical list of input fields for Surname, First name, PatientNo., Dentist, Date of Birth, Gender, Phone, Email, Address, Post Code, and Remark. At the bottom of the window are three buttons: "New Patient", "Edit Patient", and "Delete Patient".

| Surname | First name | Patient No. | Dentist | Gender | Date of Birth | Phone |
|---------|------------|-------------|---------|--------|---------------|-------|
| 秦       | 雯雯         |             | 卢仁麟     | Male   | 10/29/2021    |       |

Create a new patient or select a patient

The screenshot shows a window titled "New Patient" with two main sections: "Personal infotmation" and "File information".

**Personal infotmation:**

- Surname:
- First name:
- Date of Birth:
- Gender:
- Phone:
- Email:

**File information:**

- Patient No.:
- Dentist:
- Remark:
- Post Code:
- Address:

At the bottom right are "Ok" and "Cancel" buttons.

New Patient

After creating a new patient or select a patient, it will enter patient image management interface directly, as below picture shows:

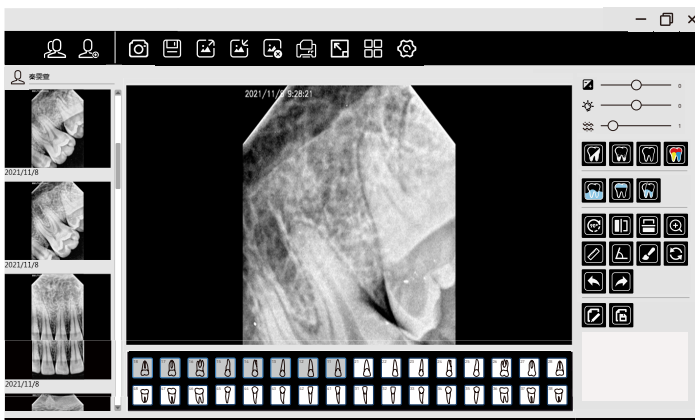

### 5.2.3 Shooting images

**Note:** Please select the calibration file before shooting to improve the image quality when first time install the software. Installation method as following:

Step 1: Plug in the USB into the device and connect the sensor.

Step 2: Click, then click "Import calibration file".

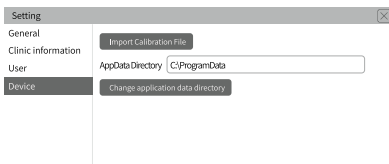

Step 3: Find the file called "Calibration File" in the USB flash disk to import all three calibration files.



#### 5.2.4 Report printing



## 5.2.5 Setting

The 'Setting' dialog box has a sidebar with 'General' selected. The main area contains three settings: 'Language' set to 'English', 'Draw Color' set to a red color swatch, and 'Brush Size' set to '2'. An 'Exit' button is at the bottom right.

General setting to choose language, draw color and brush size

The 'Setting' dialog box has 'Clinic information' selected in the sidebar. The main area contains three input fields: 'Name', 'Phone', and 'Address'. A 'Save' button is at the bottom left and an 'Exit' button is at the bottom right.

Clinic information to input clinic information which will be showed on the report

The 'Setting' dialog box has 'User' selected in the sidebar. The main area has a checkbox 'Enable user name and password' which is checked. Below it are two sections: 'Modify User Name' with 'Current User Name' and 'New User Name' input fields and a 'Modify User Name' button; and 'Modify Password' with 'Current Password', 'New Password', and 'Confirm New Password' input fields and a 'Modify Password' button. An 'Exit' button is at the bottom right.

User page to change user name, new password.

The 'Setting' dialog box has 'Device' selected in the sidebar. The main area contains four settings: 'Sensor Type' set to 'RI', 'Trigger Mode' set to 'DC', 'Trigger Threshold' set to '100uGy', and 'AppData Directory' set to 'C:\ProgramData\RF\DentalSensor'. There is an 'Import Calibration File' button and a 'Change application data directory' button. An 'Exit' button is at the bottom right.

Device page to choose the sensor type, trigger mode, trigger threshold, data directory.



## 6 Trouble shooting

| Fault                                | Possible cause and solution  |
|--------------------------------------|--|
| No image showed after X-ray exposure | Inspect the connection of sensor and computer                                  |
|                                      | Confirm whether the sensor is at the right direction towards the X-ray         |
|                                      | Change the data of trigger threshold in the "Setting-Device"                   |
|                                      | Restart the software   |
|                                      | Re-insert the sensor   |
| Image dark with stripes              | Increase exposure time   |
|                                      | Choose the right sensor type, trigger mode and trigger threshold               |
|                                      | Tube voltage from the X-ray machine too low(<60kVrms), check the X-ray machine |
|                                      | The X-ray machine too far away from the patient                                |
|                                      | Inspect the contrast and brightness of the computer                            |
| Image not clear                      | The patient moved when exposure  |
|                                      | X-ray machine not stable   |
| Image is white                       | The sensor not at the right direction towards the X-ray                        |
|                                      | The X-ray dose not enough  |
|                                      | The sensor not connected correctly   |
|                                      | X-ray machine not stable   |

## 7 Cleaning and disinfection

7.1 To further eliminate the latent danger of cross infection, in addition to using disposable protective sheath, the sensor and the front 40cm cable should be cleaned and disinfected before each patient is replaced for photographing. The recommended disinfectant for cleaning and decontamination is 70% isopropanol. It's recommended to use a cloth sprayed with aldehyde-free disinfectant to wipe and disinfect the surface.

### 7.2 Unavailable cleaning and disinfection methods

7.2.1 Do not use hard tools to clean for avoiding abrasion.

7.2.2 The following disinfectants are forbidden: trichloroethylene, dichloroethylene, ammonium hydrochloride, chlorinated hydrocarbons and aromatic hydrocarbons, dichloroethane, methylene chloride and methyl ketone.

7.2.3 Do not spray the disinfectant directly on the X-ray sensor.

## 8 Storage and transportation

### 8.1 Storage

8.1.1 This device should be handled with care, away from the source of the earthquake, and should be installed or stored in a cool, dry and ventilated place.

8.1.2 Do not mix it with toxic, corrosive, flammable and explosive materials during storage.

8.1.3 The product should be stored in an environment with a relative humidity of 10%~95%, an atmospheric pressure of 70kPa~106kPa, and a temperature of -10°C ~ +55°C.

### 8.2 Transportation

8.2.1 During transportation, excessive impact and vibration should be prevented. Handle it with care and avoid inversion.

8.2.2 It should not be mixed with dangerous goods during transportation.

8.2.3 Avoid sunlight, rain or snow during transportation.

## 9 After service

Since the date of sale, if the device fails to work normally due to quality problems, our company will be responsible for the maintenance with the warranty card. Please refer to the warranty card for the warranty period and scope. This product does not contain self-maintained parts, and the maintenance of this device should be carried out by designated professionals or special technician.

We will not be liable for defects or their consequences if they are likely to be a direct result or actions or modifications by customers or third party.

## 10 Electromagnetic compatibility

### 10.1 EMI compliance table

| Phenomenon   | Compliance                | Electromagnetic environment                  |
|--------------|---------------------------|--|
| RF emissions | CISPR 11 Group 1, Class B | Professional healthcare facility environment |

### 10.2 EMS compliance table

#### 10.2.1 Enclosure USB port

| Phenomenon  | Basic EMC standard | Immunity test levels   |
|---|--------------------|--|
|   |                    | Professional healthcare facility environment                           |
| Electrostatic Discharge                               | IEC 61000-4-2      | ±8 kV contact, ±2kV, ±4kV, ±8kV, ±15kV air                             |
| Radiated RF EM field                                  | IEC 61000-4-3      | 3V/m ,80MHz-2.7GHz,80% AM at 1kHz                                      |
| Near fields from RF wireless communications equipment | IEC 61000-4-3      | Refer to table "Near fields from RF wireless communications equipment" |
| Rated power frequency magnetic fields                 | IEC 61000-4-8      | 30A/m 50Hz or 60Hz   |

### 10.2.2 Near fields from RF wireless communication equipment

| Test frequency(MHz) | Band(MHz) | Immunity test levels                         |
|---------------------|-----------|--|
|                     |           | Professional healthcare facility environment |
| 385                 | 380-390   | Pulse modulation 18Hz, 27V/m                 |
| 450                 | 430-470   | FM, ±5kHz deviation, 1kHz sine, 28V/m        |
| 710                 | 704-787   | Pulse modulation 217Hz, 9V/m                 |
| 745                 |           |  |
| 780                 |           |  |
| 810                 | 800-960   | Pulse modulation 18Hz, 18V/m                 |
| 870                 |           |  |
| 930                 |           |  |
| 1720                | 1700-1990 | Pulse modulation 217Hz, 28V/m                |
| 1845                |           |  |
| 1970                |           |  |
| 2450                | 2400-2570 | Pulse modulation 217Hz, 18V/m                |
| 5240                | 5100-5800 | Pulse modulation 217Hz, 9V/m                 |
| 5500                |           |  |
| 5785                |           |  |

Recommended separation distances between portable or mobile RF communication device and detector:

Portable RF communications equipment, including antennas, can effect medical electrical equipment. The warning should include a use distance such as "be used no closer than 30 cm (12 inches) to any part of the i-Sensor H1 / i-Sensor H2, including cables by the manufacturer".

### 10.2.3 Cable provided for EMC

| Cable | Recommended length | Shielded/Unshielded | Number | Cable classification |
|-------|--------------------|---------------------|--------|----------------------|
| Cable | 2.8m               | Shieled             | 1 pc   | DC power and SIP/SOP |

### 10.2.4 Electromagnetic Compatibility (EMC)

The dental sensor need special precautions regarding EMC, and should be installed by authorized personnel and follow EMC guidance in the user manual. The product when in use may interfere with portable and mobile RF communication devices such as mobile (cellular) telephones. Electromagnetic interference may result in incorrect operation of the system and a potentially dangerous situation.

The dental sensor should not be stacked with or adjacent to other devices. If inevitable, verify the product.

The dental sensor conforms to the IEC60601-1-2:2014 and EN60601-1-2:2015 standard on both immunity and emissions.

Accessories, transmitters and cables other than those by the user manual or sold together with product may result in increased emissions or decreased immunity of the product.

#### **Notes:**

Without the explicit consent of our company, unauthorized changes or modifications to the equipment may cause electromagnetic compatibility problems of this equipment or other equipment.

## 11 Statement

All rights of modifying the equipment design, product technology or accessories, manual and packaging content at any time are reserved to the manufacturer without further notice.



## After service and Warranty Instruction

1 Period validity:

One year's warranty.

2 Range of warranty:

Within the warranty period of validity, we are responsible for any troubles caused by quality problems or products technique and structure.

3 The followings are beyond our warranty:

1) The damage caused by disobeying the operation instruction or lack of the needed condition.

2) The damage caused by unsuitable operation or disassembly without authorization.

3) The damage caused by unadvisable transportation or preservation.

4) There isn't the seal of distributor or the warranty card isn't filled in completed.

# ADAE

## Your Trust Is Our Success

[www.adae.store](http://www.adae.store)

ADAE International Dental Store

GuangTangXi road-TianHe district-Guangzhou-China

[service@adae.store](mailto:service@adae.store)

Tel: 008618300190504

WhatsApp and Viber available