

ADAE

AD003 dental suction unit user manual

Please read carefully of this manual before using the product, especially the safety precautions.

The malfunction and loss due to inobservance of this manual is not included in the warranty coverage.

Please well store the purchasing evidence and all other documents in the package for further usage.

Functions

► This product control the suction flow rate by pressure changes in the pipeline automatically which can effectively reduce the energy consumption and increase the efficiency.

Centrifugal circulating motor: strong power, airflow buffering design, low noises, high pressure and large air quantity;

The filter system applies the current advanced mechanical filtering technology in water treatment process which can effectively remove colloid and other solid particles of water;

The high performance moisture separation system further enables this product to maintain stable separating effects with high flow capacity. The resistance is small and it is simple in maintenance. It can effectively guarantee the long-time running of the motor.

► **This product is suitable for oral treatment with dental treatment machine with the elimination of droplets inside the patient's mouth, saliva and food debris.**

Safety precaution



- 03 Important safety symbol
- 04 For installation
- 04 For power
- 05 For running
- 06 For cleaning
- 06 For environment
- 06 EMC

Name of Essential Components



Key Parameters



Install Product



- 09 Remove the packaging of the suction system
- 09 Installation conditions
- 09 Illustration of normal operation conditions
- 10 Normal operation of the product
- 10 Suction system pipe's installation suggestion
- 11 Line connection
- 11 Use after connection

Cleaning and Maintenance



- 12 Cleaning the products outside
- 12 Cleaning the filter net
- 12 Cleaning the pipeline

Trouble Shooting



Appendix



- 13 Electrical schematic diagram
- 14 Pipeline connection diagram

Safety Precaution

Important safety signs

In the following parts you shall see the notes of " **WARNING** " and " **CAUTION** " .

All of these warnings, cautions and subsequent significant safety instructions do not include all possible cases.

So before installation, use and maintenance of this product, read carefully these instructions and operation guides. Our company shall not be responsible for any losses due to misuse.

This manual must be properly kept together with the products.

The implications of the icons and signs on this product:



Be careful!

Any unsafe operation may cause personal injuries or property damage!



Be careful!







The equipment surface is very hot! Do not touch it directly with your hand!







Warning!

The interior components and parts are energized, so cut off the power before any operation!





The implications of the icons and signs in this manual:

 WARNING	Danger or unsafe operation may cause SERIOUS PERSONAL INJURIES OR DEATH!
 CAUTION	Danger or unsafe operation may cause MINOR PERSONAL INJURIES OR PROPERTY DAMAGE!
	Follow the orders!
	Please do not make attempt!
	Be sure that the ground connection in case of electric shock
	Pull out the plug
	Do not disassemble

For Installation

-  **Warning:** Do not install this product near the heater or any combustible materials.
Do not install this product in wet, oily or dusty places.
Do not install this product in places exposed to sunshine or water (rain).
Do not install this product in any place where flammable gas leak is possible.
 - ▶ Any nonobservance may cause electric shock or fire.
-  **Warning:** Do not install this product in small closed space or the room can't adjust the temperature.
 - ▶ If not, may cause abnormal vibration, noise or product problems.
-  **Caution:** Install the product on hard ground which can bear its weight.
 - ▶ Any nonobservance may cause abnormal vibration, noises or product problems.
-  **Caution:** Check whether the air inlet and the air outlet are blocked.
 - ▶ Any nonobservance may cause product problems or reduce the suction efficiency.

For Power









-  **Warning:** Plug the power cord into the wall socket according to the power specification and the socket is used for this product only. In addition, this product requires reliable ground connection. Do not use extension cord.
 - ▶ The use of the multi-socket power panel or the sharing of the same wall socket or power cord with other products may cause electric shock or fire.
 - ▶ The difference in voltage/frequency/rated current may cause electric shock or fire.
-  **Warning:** Connect the power plug to the wall socket firmly. Don't use a damaged power plug, a damaged power cord or a loose wall socket.
 - ▶ Any nonobservance may cause electric shock or fire.
-  **Warning:** Do not drag the power cord when pulling the electric appliance plug.
 - ▶ Hold the plug first and then pull it.
 - ▶ Any nonobservance may cause electric shock or fire.
-  **Warning:** Do not drag or bend the power cord excessively.
Do not wind or tie up the power cord.
Do not hang the power cord on any metal object.
Do not place any heavy object on the power cord.
Do not put the power cord between two objects or push the power cord behind the product.

Safety Precaution



- ▶ If the power cord is damaged, ask professionals in the maintenance department or its equivalents to replace it to avoid danger.
- ▶ Cut off the power supply before cleaning or maintenance.

-  **Caution:** Please cut off the power if this products shall not be used for an extended period of time or during thunder and lightning storm.
 - ▶ Any nonobservance may cause electric shock or fire.



For Running

-  **Warning:** All the operation parameters of frequency converter is set in the factory, self-regulating by users is forbidden.
 - ▶ If change it without authorization , may cause equipment failure.
-  **Warning:** If the water enters the closed pipeline, please turn it off and contact the after-sale service department.
If the product makes weird noises or burning smell or smokes, turn it off immediately, cut off the power and contact the after-sale service department.
 - ▶ Any nonobservance may cause electric shock or fire.
-  **Warning:** In case of leakage of inflammable gas (such as propane and liquefied petroleum gas), ventilate immediately and don't touch the power plug.
 - ▶ Do not use the ventilating fan.
 - ▶ Sparks may cause explosion or fire.
-  **Warning:** Do not touch the power plug with hands wet.
 - ▶ Any nonobservance may cause electric shock.
-  **Warning:** Keep all of the packaging materials beyond children's reach after the packaging is removed.
 - ▶ If children put the bag over the head, they may feel suffocated.
-  **Warning:** Do not put your finger or other object into the air inlet or the air outlet.
 - ▶ Be careful. Fingers or other objects put into the air inlet will leads to injury or damage of product.
 - ▶ The temperature of Vent and the connected pipeline is very high when the equipment working which may cause burn.
-  **Warning:** Do not knock or drag the product forcefully.
 - ▶ Any nonobservance may cause fire, injuries or product problems.
-  **Warning:** Do not try to repair, demount or reassemble the product by yourself.
If don't like this, it may leads electric shock, product problems or injuries.

Safety Precaution

-  **Caution:** Please do not stand on or put heavy objects or dangerous items (for example: lighted candles, lighted cigarettes, corrosive chemicals lights) on the product.
 - ▶ If do not like this, it may leads burn, fire or electric shock.
-  **Warning:** After the operation, the motor cooling fins will gradually produce high temperature. no touch with hands. It is forbidden to wind the power cord to the motor or contact with the metal parts. ♦ If do not like this, it may cause burns, fire, electric shock, etc.
 - ▶ If do not like this, it may cause burns, fire, electric shock, etc.

For Cleaning

-  **Warning:** Cut off the power supply first and then clean the product.
 - ▶ Any nonobservance may cause electric shock.
-  **Warning:** Do not clean the product by means of direct spray.
Do not use benzene, diluents or alcohol to clean the product.
 - ▶ Any nonobservance may cause color fading, electric shock or fire.
-  **Warning:** Do not use cleaning agent with air bubble or corrosive agents to wash pipeline.
 - ▶ Cleaning agent with air bubble is likely to cause reflux, leading the damage of suction motor.

For Environment

The product must be disposed according to local laws and regulations. Please contact the local recycling center or the national recycling organization to obtain more information.

EMC

Portable and mobile RF communication equipment should not be used no closer to the equipment, including cables. Interference may occur in the vicinity of equipment marked with right symbol:



According to the common sense, the electromagnetic intensity Generated from a fixed transmitter can't be accurately predicted. Such as: wireless telephone, land mobile radio equipment, the amateur radio channel, AM and FM radio and television broadcasting, etc. In order to predict the fixed emitter manufacturing electromagnetic environment, the electromagnetic survey at the scene of the product installation should be referred. If this product use location measured magnetic field strength more than the use of radio frequency (rf) level, we should observe whether the product is able to function properly. If abnormal performance appear, it is necessary to take additional measures, such as to adjust or move this product to other places.

Names of Essential Components

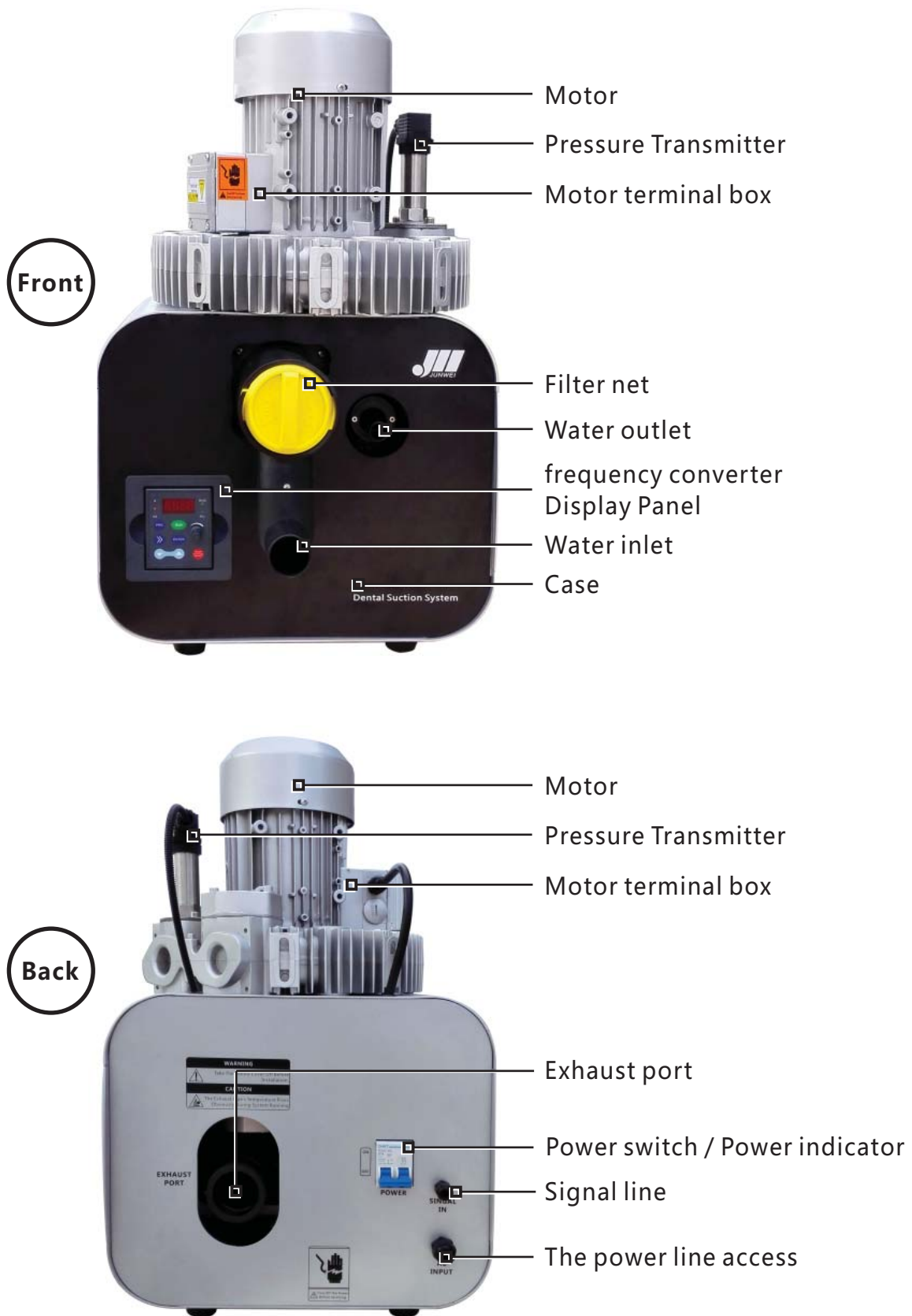

Key Parameters

Type	AD003
Power Specification	110-220V
Frequency	50~60Hz
Frequency Capacitor	1.5kw
Rated current	6.9A
Motor Speed	2780~3320rpm
Max Gas Flow	1100L/min
Vacuum Degree	-180mbar
Support Sets	3-5
Noise	58dB(A)
Product Size	L385*W485*H615mm
Product Weight	36kg

Notice: The design and specifications may be changed to improve the product without prior notice.

Product Installation

Remove the packaging of the suction system

- ▶ After remove the packaging of the suction machine check whether the product is damaged during transportation immediately. At the same time, check whether all of the parts and components in the packing list are present. If not, please report to the distributor of the company immediately.
- ▶ Spare parts and Accessories:

Intake-tube	grey/inner diameter 40mm	1
Exhaust pipe	black/inner diameter 38mm	1
Metal buckles		2
Metal hole hoops	diameter 40-64mm	2
Operating manual		1

Installation Conditions

- ▶ Indoor, flat and hard ground.
- ▶ Avoid direct sunlight; guarantee a clean environment free of pollution and corrosive gas.
- ▶ Ventilating fans and 50mm diameter vent holes must be installed in the motor room where this product shall be located so that the waste gas shall be discharged outside and the air in the motor room shall be fresh;
- ▶ Besides, there should be equipped with 20 mm inner diameter sewers in the room to ensure the discharge of waste liquid from suction system.
- ▶ The product should be installed near the power plug; The power must have reliable grounding wire.
- ▶ Be kept away from the heat source and combustible materials. Keep enough space around the suction system to the benefit of the air circulation.
- ▶ Please keep the installation place not to connect directly or indirectly with the wet objects.

Illustration of normal operation conditions

- ▶ Ambient Temperature Range: +5°C----- +40°C
- ▶ Relative Humidity Range: ≤ 70%
- ▶ Atmospheric Pressure Range: 700Hpa-1060Hpa

Suction system pipe's installation suggestion

Suggestion: Laid each suction feeder line of the dental chair separately, connected to the main pipeline with 50mm diameter PVC pipe near the suction system. When meet the angle while laying, try best to make 45° angle connection mode.

Pre-cast the PVC pipe with 32mm diameter. The height from the ground is 10cm.

Suggestion: Pre-cast the suction system control pipe (signal line) with 15mm diameter PVC pipe. Keep fuses in the pipe. The height from the ground is 10cm.

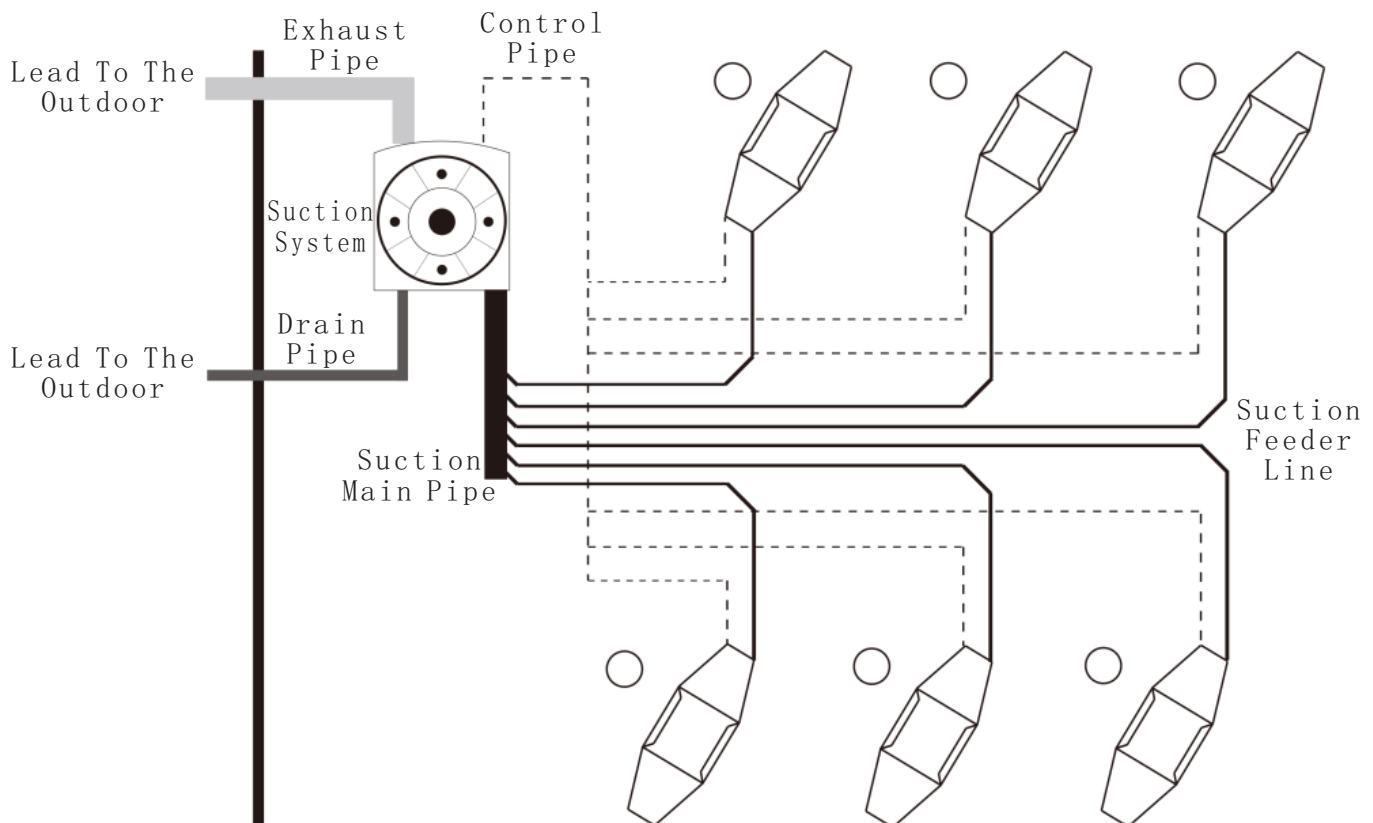

Product Installation

Pipeline/signal line connection

Inlet pipe connection of suction system

First connect the inlet pipe from the accessories to the air inlet of the suction system:

- ▶ Both hands operation, one hand withstand the back of air inlet of suction system, the other hand holding the inlet pipe with rotation connection at one end.
- ▶ fixed with the metal hose hoop after connection.
- ▶ Then connect the inlet pipe's other end to the dental chair's strong, weak suction pipe's (or reserved underground main pipe) port.

Exhaust pipe connection of suction system

Connect the exhaust pipe's one end to the vent back of the suction system:

- ▶ After removing the the plastic buckle at the port, insert the inlet pipe into the exhaust pipe. Put on the original plastic buckle to match the exhaust pipe groove until not easy to pull out lightly.
- ▶ Then strengthen by the metal hose hoops from the accessory.
- ▶ Connect the other end of the exhaust pipe to the metope exhaust hole (or the reserved exhaust manifold).

Caution: The exhaust Pipe's temperature rises obviously during system running, extended exhaust pipe should use metal pipe that can sustain more than 80 degrees Celsius temperature or resist heat tube.

Drain pipe connection of suction system

Connect the outlet pipe's other end to the sewer line.

The connection between suction system and the signal line of dental chair

The signal line for this product and dental treatment chair is one cable with two guide line which is close to the power line at the back of crate.

Connect the signal line with the control switch of dental treatment chair's strong and weak absorption.

Use after connection

Prepare to work after switch on

- ▶ Plug in, turn on the green power at the back of crate. The suction system enters holding state when the indicator light on.
- ▶ Take the strong and weak absorption from the dental chair and the suction system begins to work.

 **All the operation parameters of frequency converter is set in the factory, self-regulating by users is forbidden.**

Cleaning and Maintenance

Regular maintenance for the suction system can effectively reduce the occurrence of accident. Make your equipment in good working condition and prolong its service life.

The operator must wear masks and waterproof gloves when taking the clean and maintenance.

Clean The Exterior Part

Be sure to stop the machine and pull the plug from the power socket before this step.

- ▶ Immerse the soft towel into the hot water and wring it dry. Then use it to wipe the suction system.

Caution: Do not use alkaline detergent to clean the control panel.

Caution: The coarse cloth or dirty cloth containing particles may scratch and damage the surface of the suction machine. Therefore, it is better to use soft cloth.

Clean The Filter Net

Suggest to clean the strainer screen twice a week in In order to avoid equipment pumping efficiency lower.

Be sure to stop the machine and pull the plug from the power socket before this step.

- ▶ Take out the filter screen from the filter according to the type of the suction machine and the diagram. Flush the screen with clean water.

Caution: If there are adhesive objects in the filter screen, use a soft hairbrush to wash out so as not to damage the screen.

Caution: Check if it is tighten after cleaning and put the strainer screen back to equipment, or leakage of water and gas will appear.



Clean the pipeline

Please intall the cleaned strainer screen back to the equipment and check if the pipeline is connected properly before operation. Do not use cleaning agent with air bubble or corrosive agents to wash pipeline. cleaning agent with air bubble is likely to cause reflux, leading the damage of suction motor.

- ▶ Dilute the multienzyme cleaning concentrated solution for medical purposes into 1:100-1:300 cleaning solution according to the pollution level.
- ▶ Switch on the suction machine. Inhale the diluted cleaning solution from the strong and weak absorption of dental chair into the pipe for cleaning.

Trouble shooting

Phenomena	Analysis	Solutions
The suction system cannot be activated	Whether the power plug is connected	Plug the power plug
	Whether the power switch is on	Turn on the power switch
The efficiency of the suction machine decreases	Suction inlet blocked	Clean the filter net
	Gas leakage of dental chair pipeline	Check all the suction pipeline and connector of dental chair
Motor overload	Low voltage	Check the power
		Check power source Check wire size and wire connection

Before contacting the after-sale department:

- ▶ Try to solve the problem (see "Trouble shooting").
- ▶ If the fault is still present, contact the after-sale department and provide relevant information.

Appendix

Electrical schematic diagram

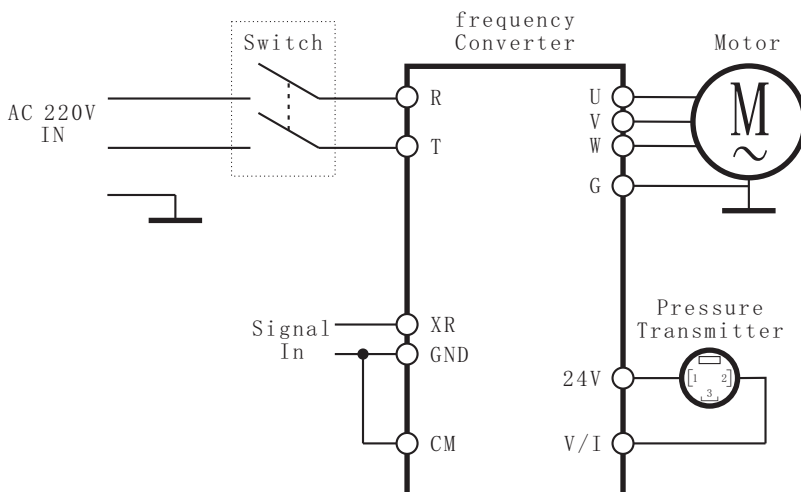

Pipeline connection diagram

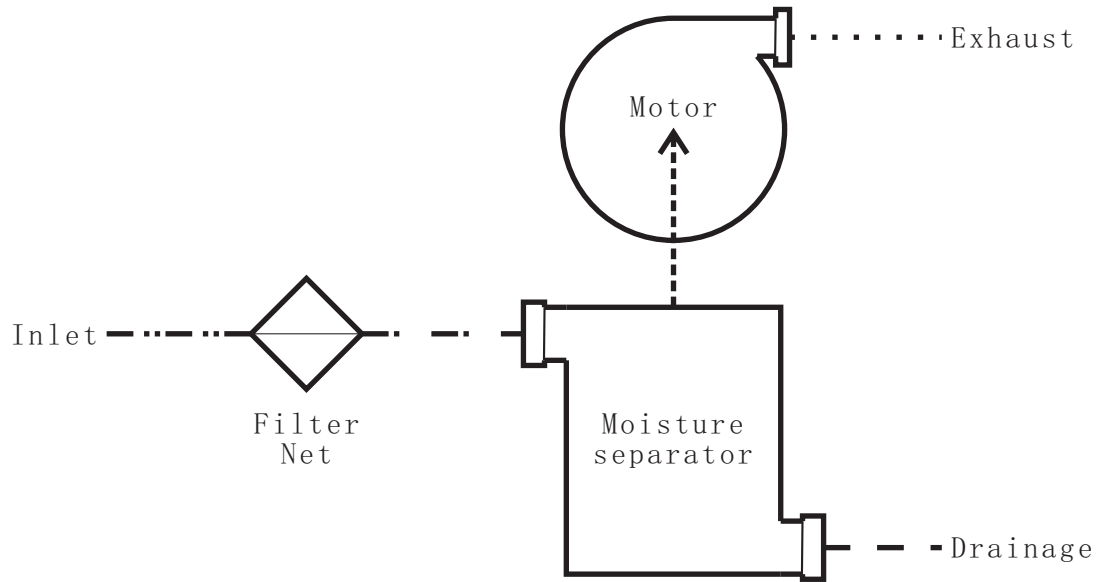

Model:	
S/N:	
Production date:	
QC:	