

THIN 27_THPW

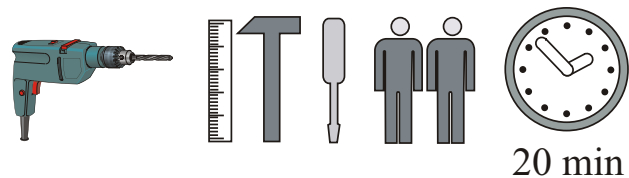

NO	Dim.		Col.-No	Qty
1	1500	124	1	1
2	1496	184	1	1

THIN 27_THPW

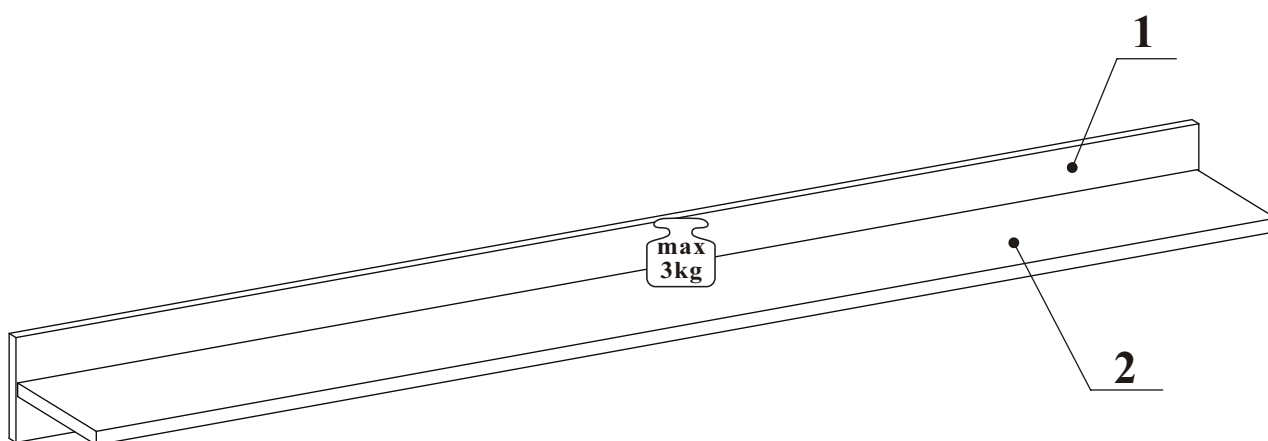
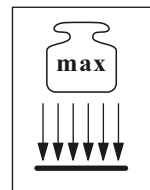
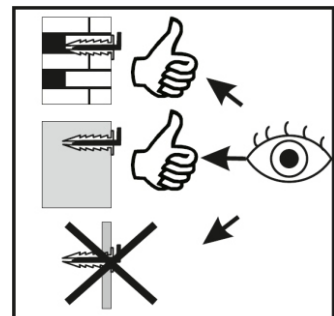
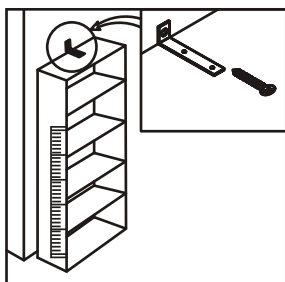
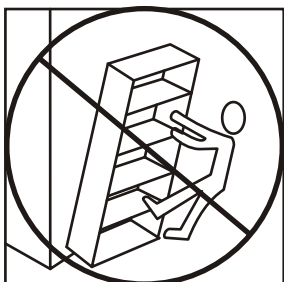
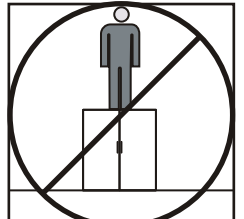
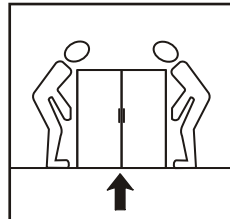
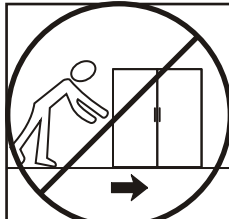
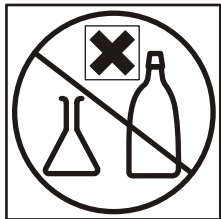
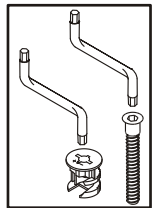
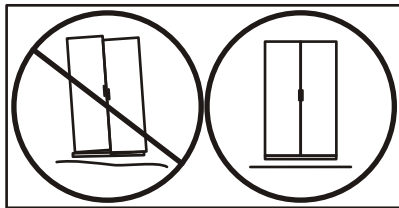
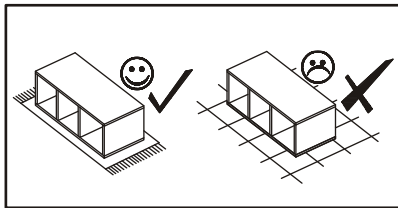
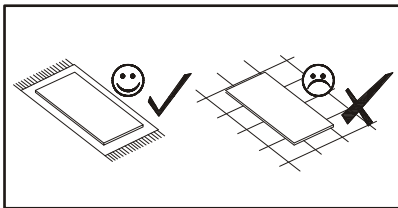
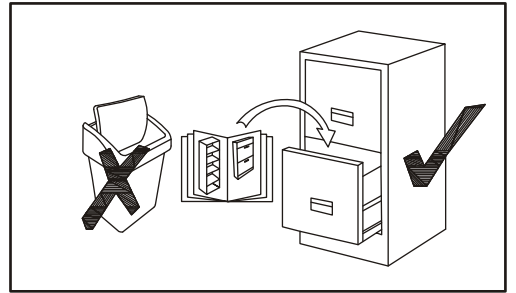
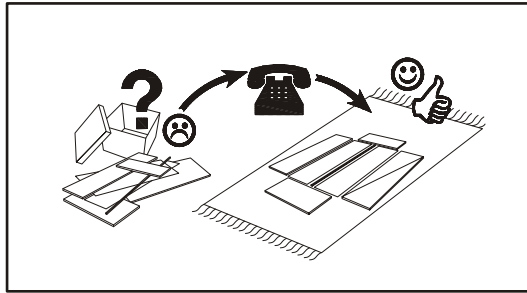
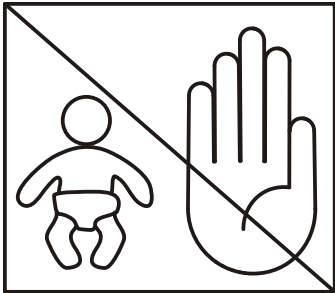
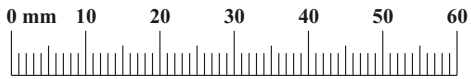
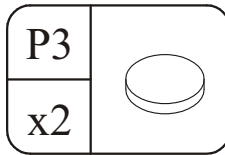
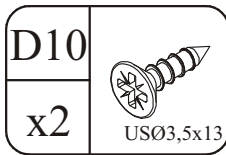
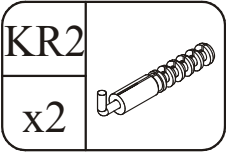
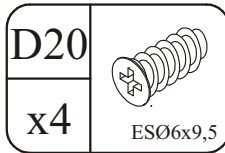
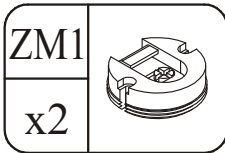
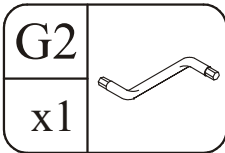
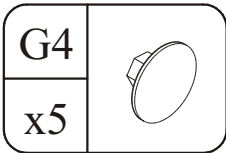
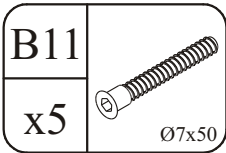

1

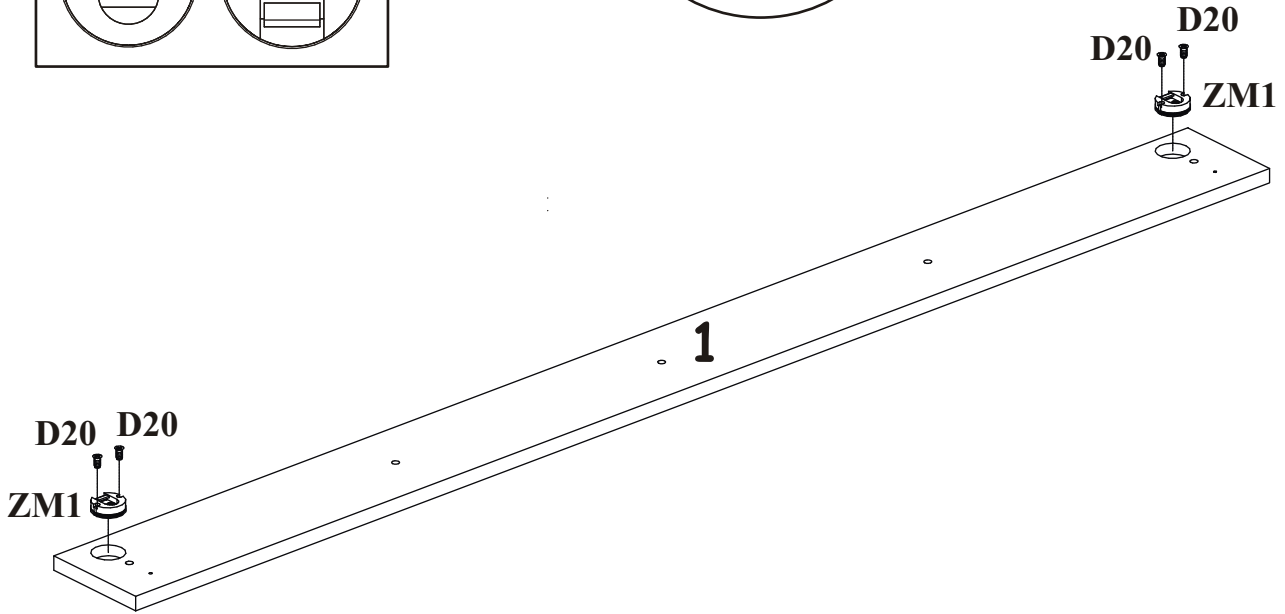
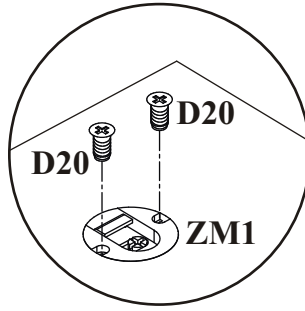
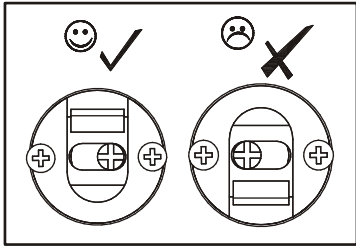

2

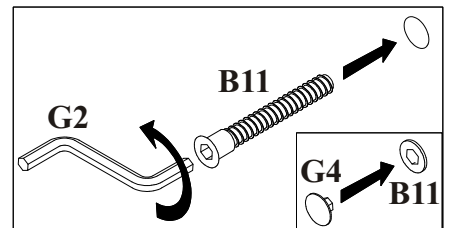
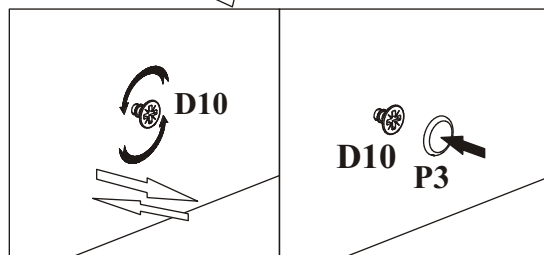
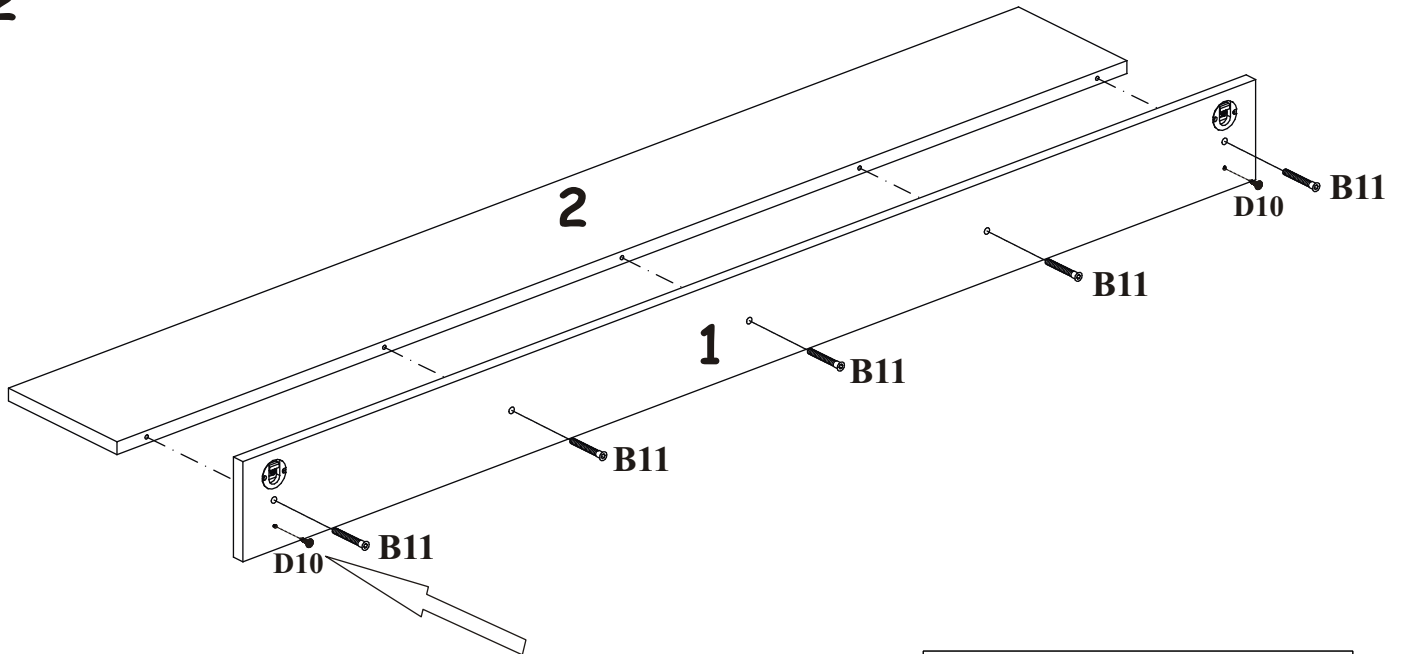

3

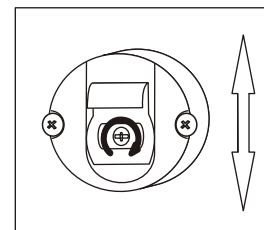
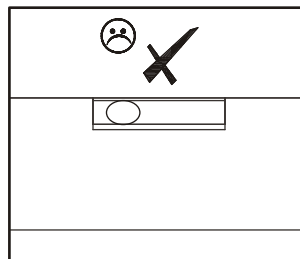
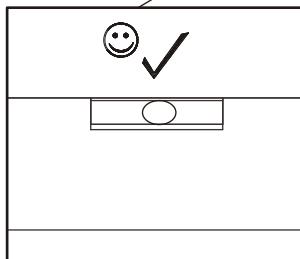
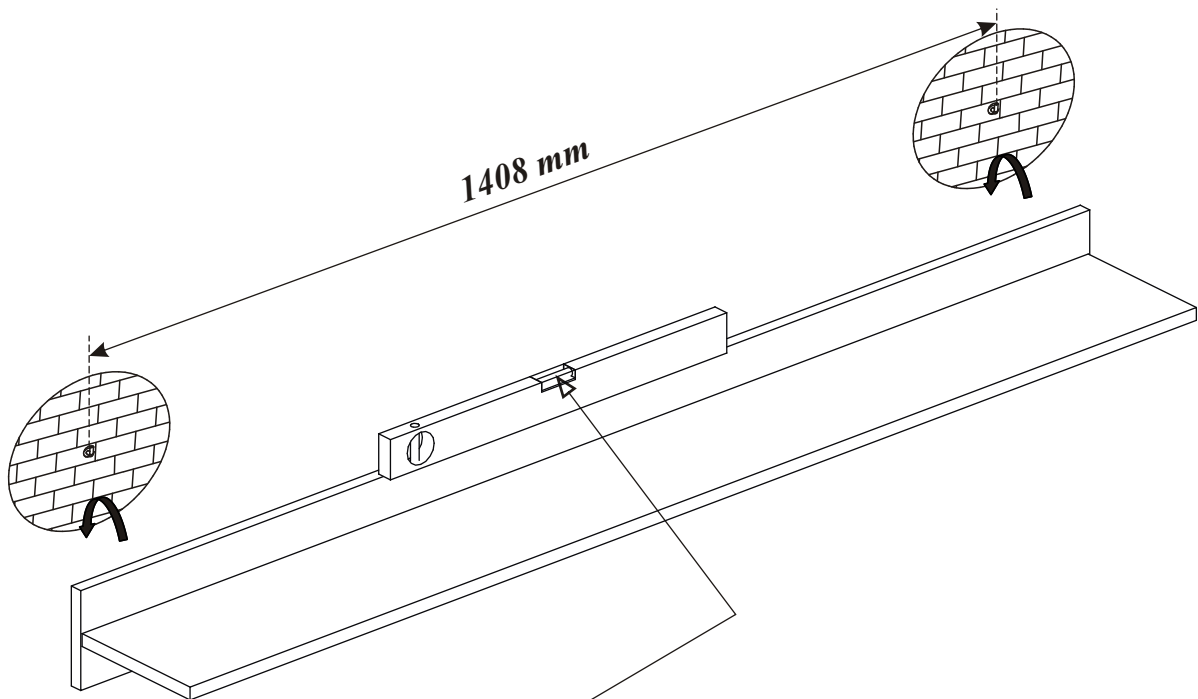
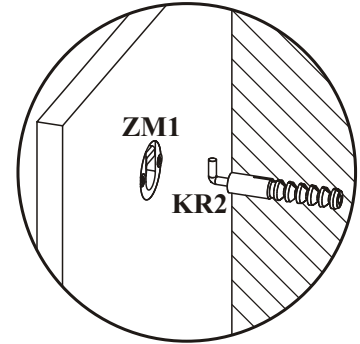
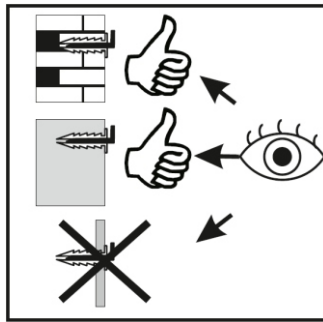
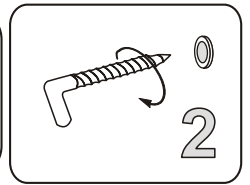
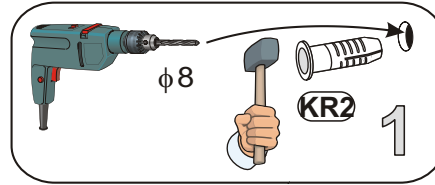
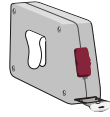

THIN 27_THWSN

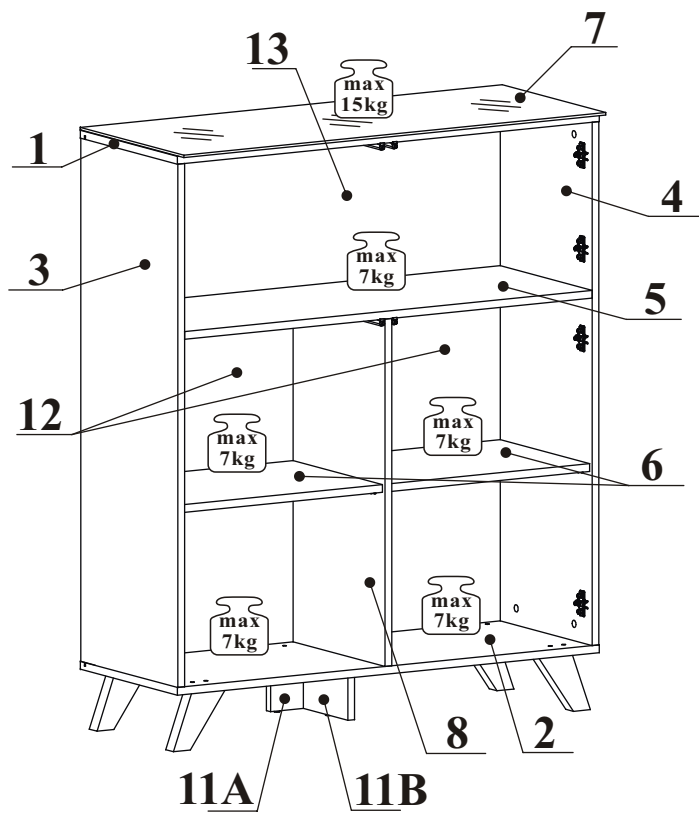
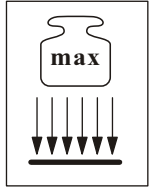
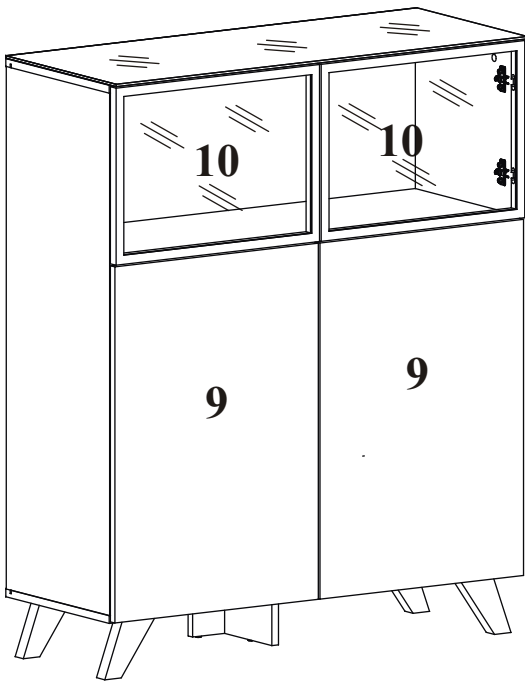



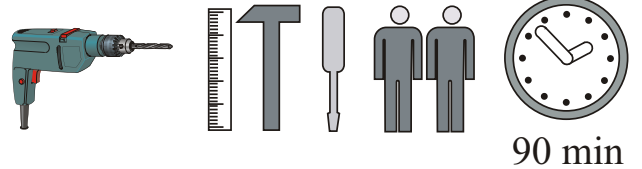





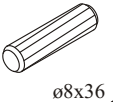
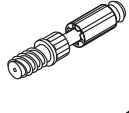
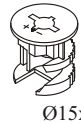

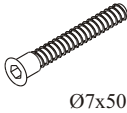

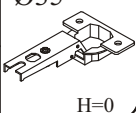
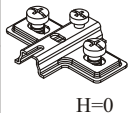
NO	Dim.		Col.-No	Qty
1	1002	376	1	1
2	1002	376	1	1
3	1074	376	1	1
4	1074	376	1	1
5	968	356	1	1
6	476	346	1	2
7	1002	401	1	1
8	713	356	1	1
9	496	732	2	2
10	496	364	2	2
11A	115	172	1	1
11B	115	172	1	1
12	490	727	2	2
13	980	359	1	1

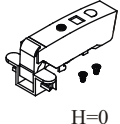
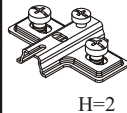
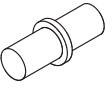
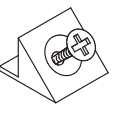
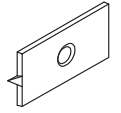

90 min

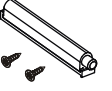
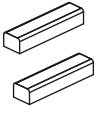
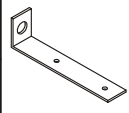
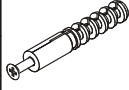
THIN 27_THWSN

A1 x16  ø8x36	B4 x16 	B5 x16  Ø15x12	G5 x16 	B11 x14  Ø7x50	G4 x14 
E21 x4 Ø35  H=0	E2 x4  H=0	D10 x18  USØ3,5x13	E30 x4  H=0	E4 x4  H=2	G7 x8 
S1 x16 	G16 x10 	UP13 x10  UPØ3x16	SK x4  H=120	I2 x3 	OD1 x4 
LED X2 	L1 x1 	KR1 x1 	G2 x1 		

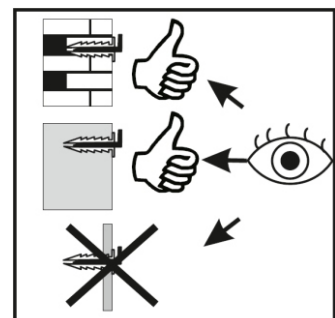
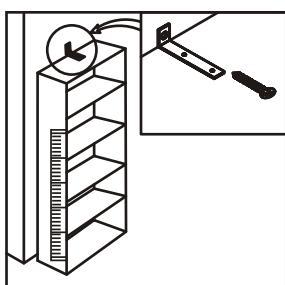
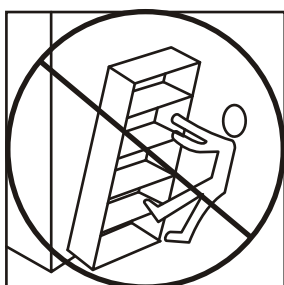
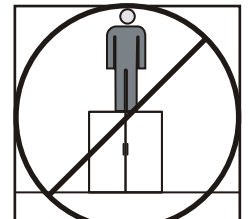
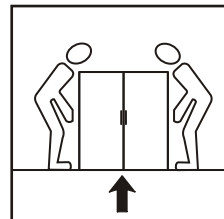
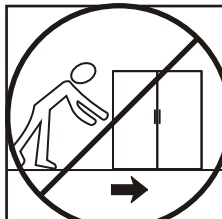
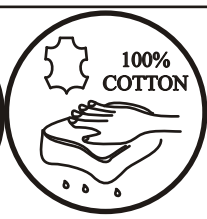
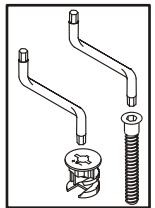
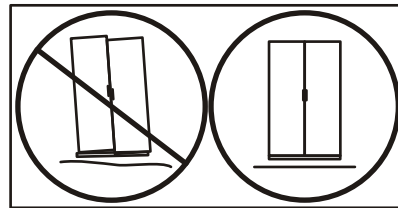
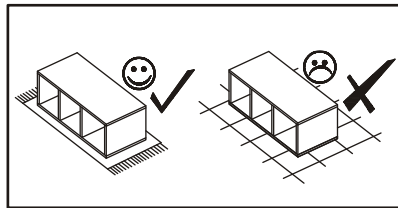
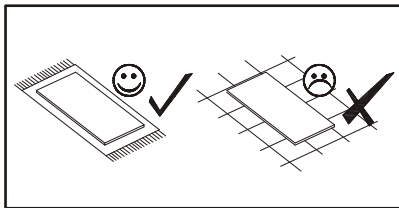
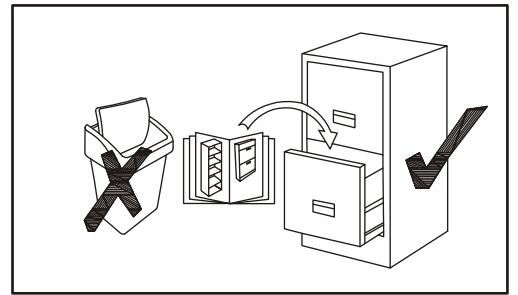
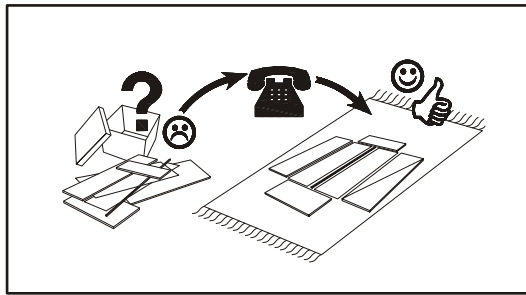
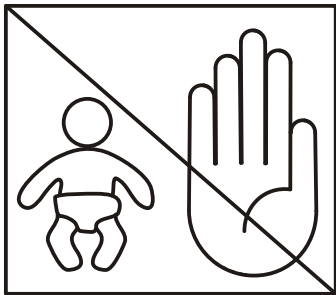
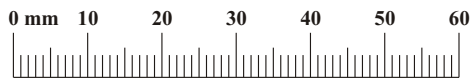

1

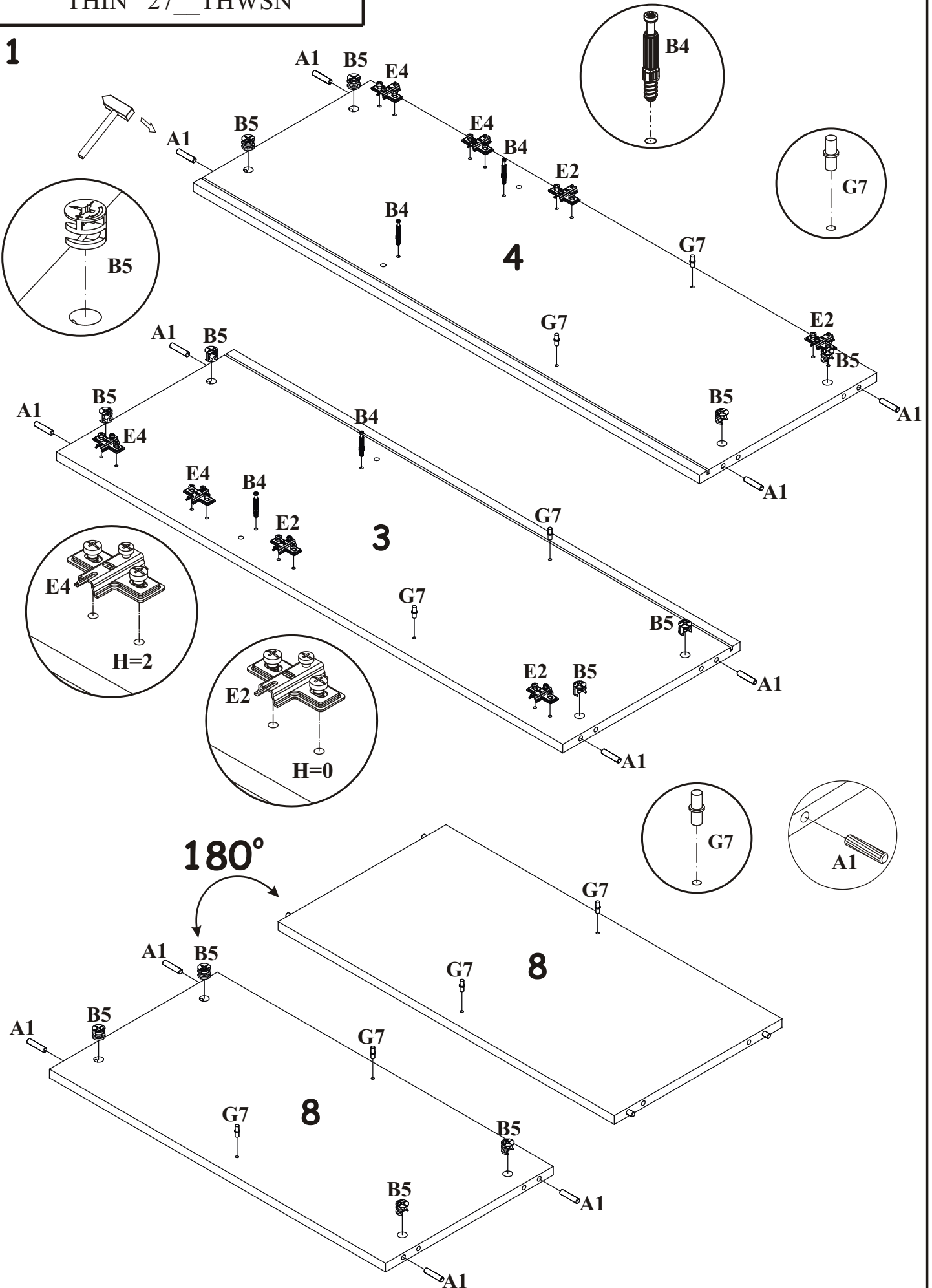

2

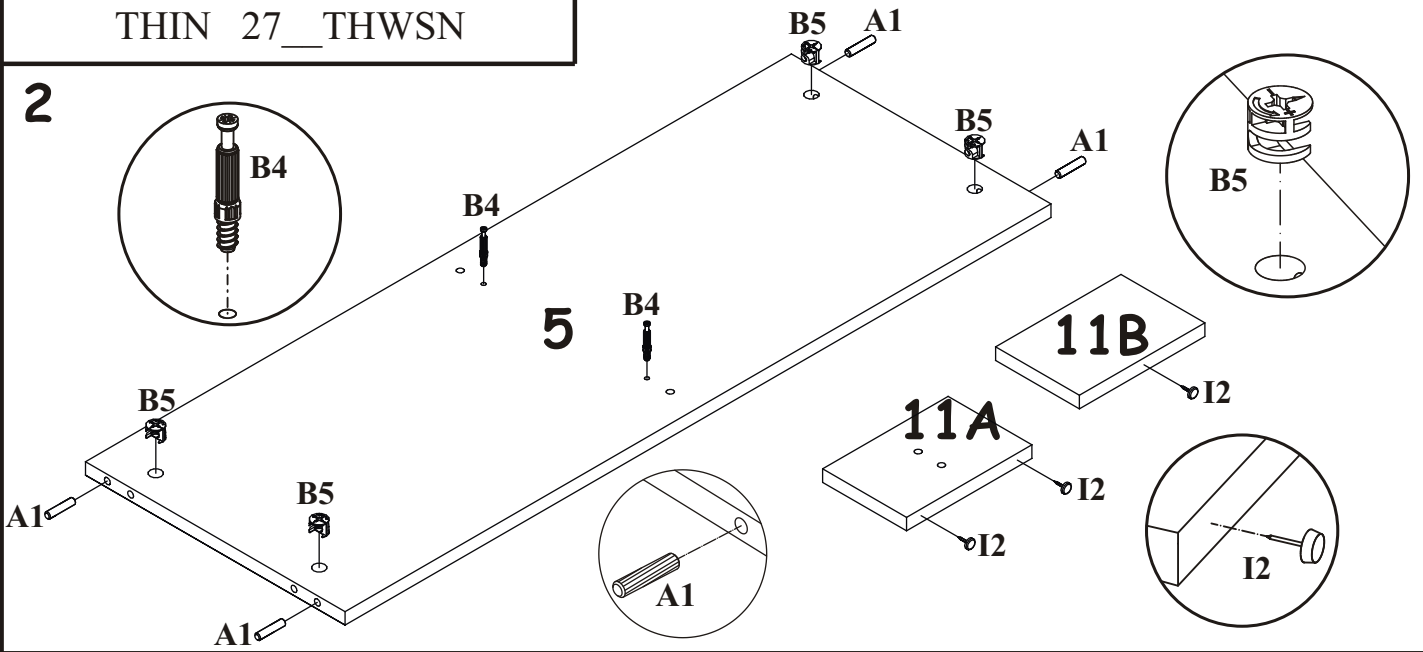

3

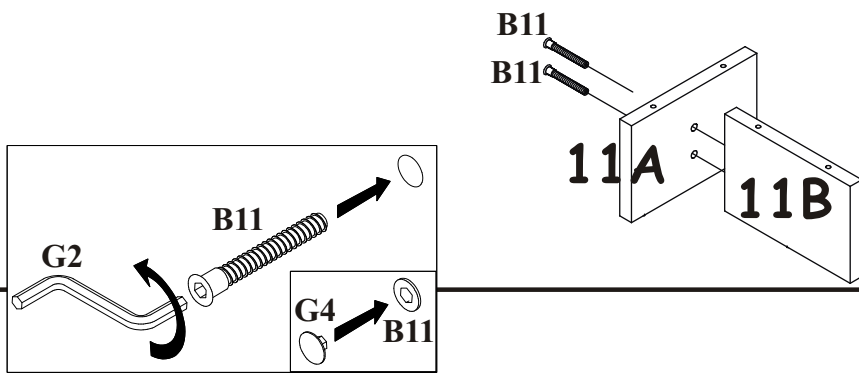

4

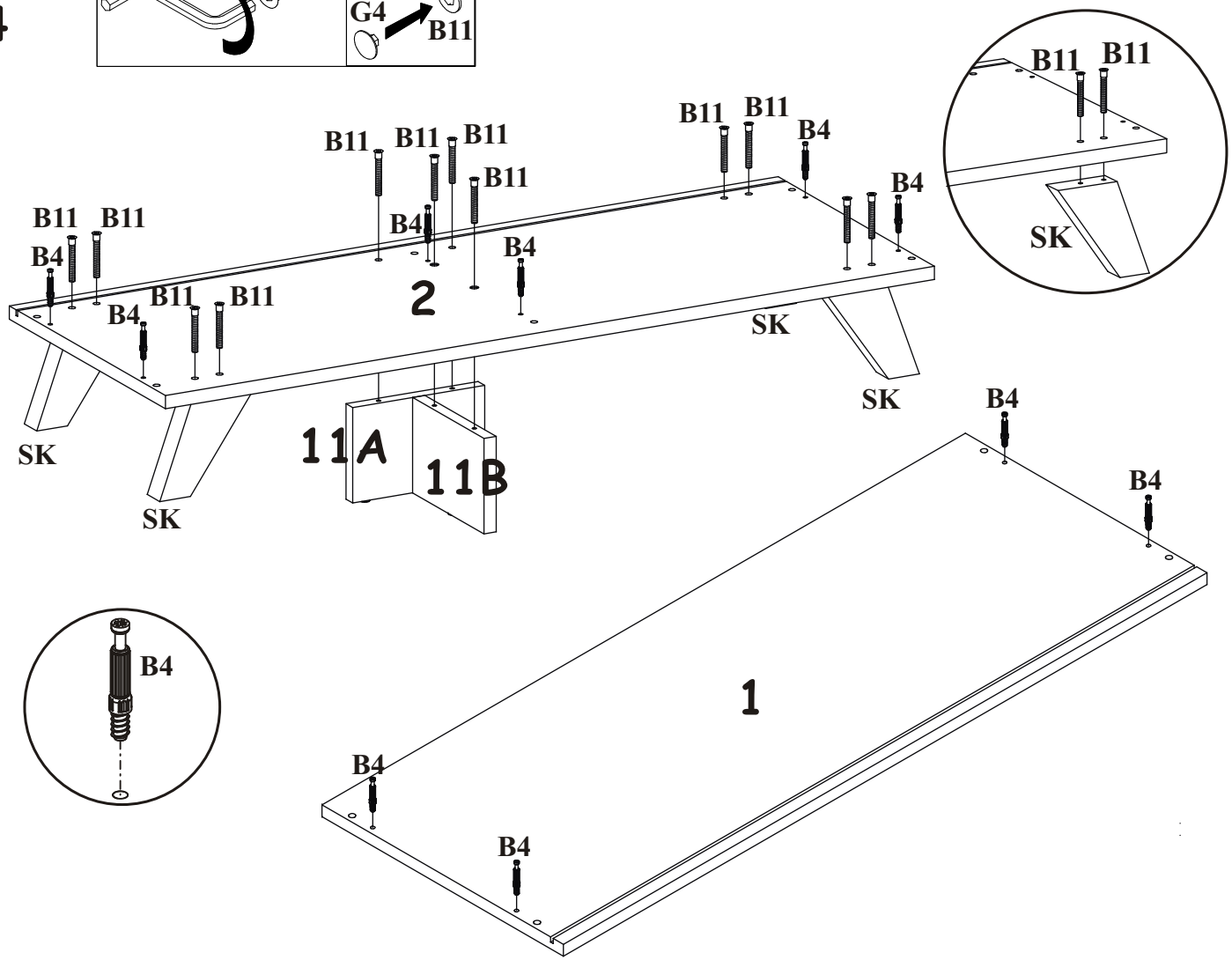

5

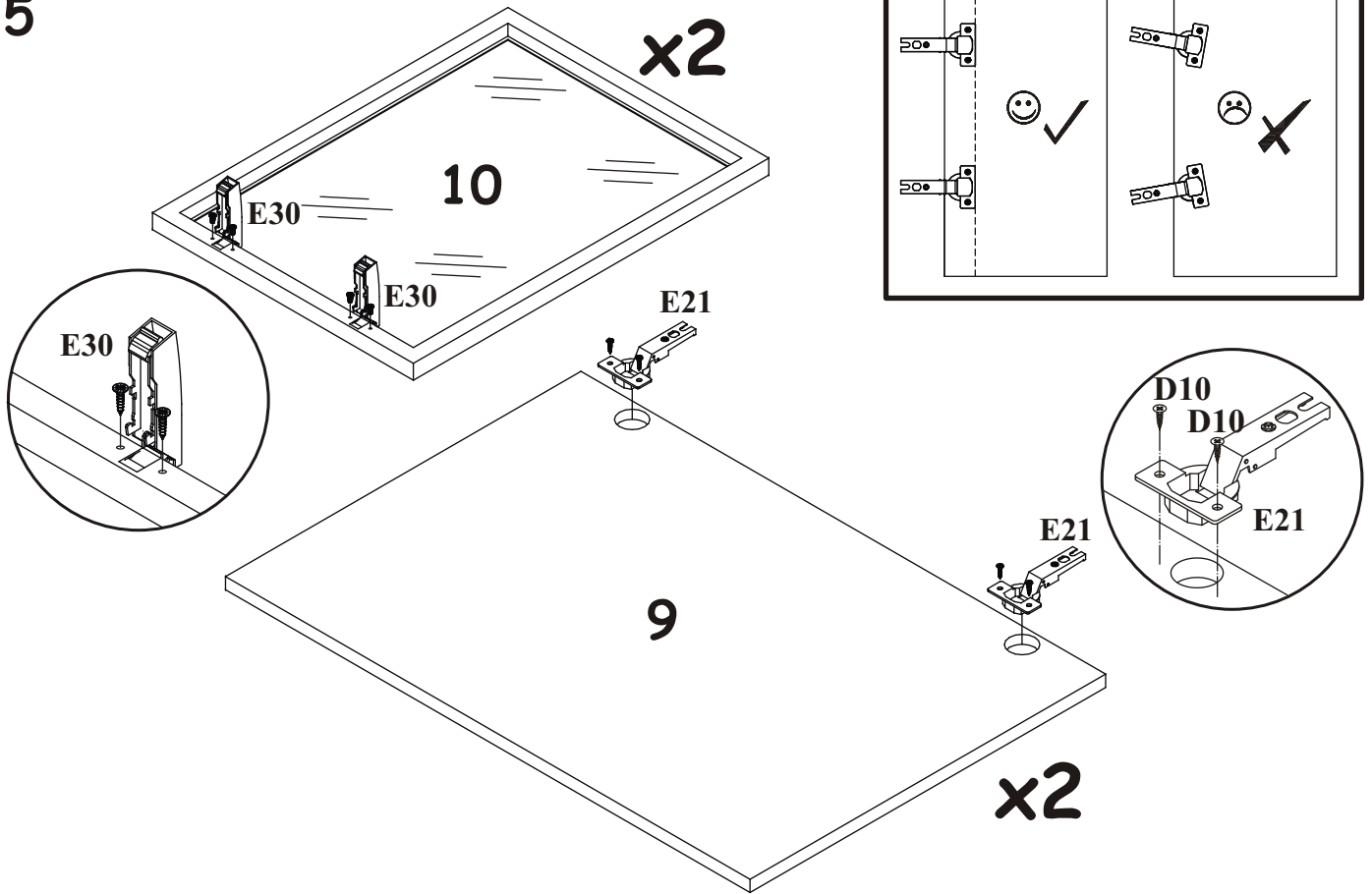

6

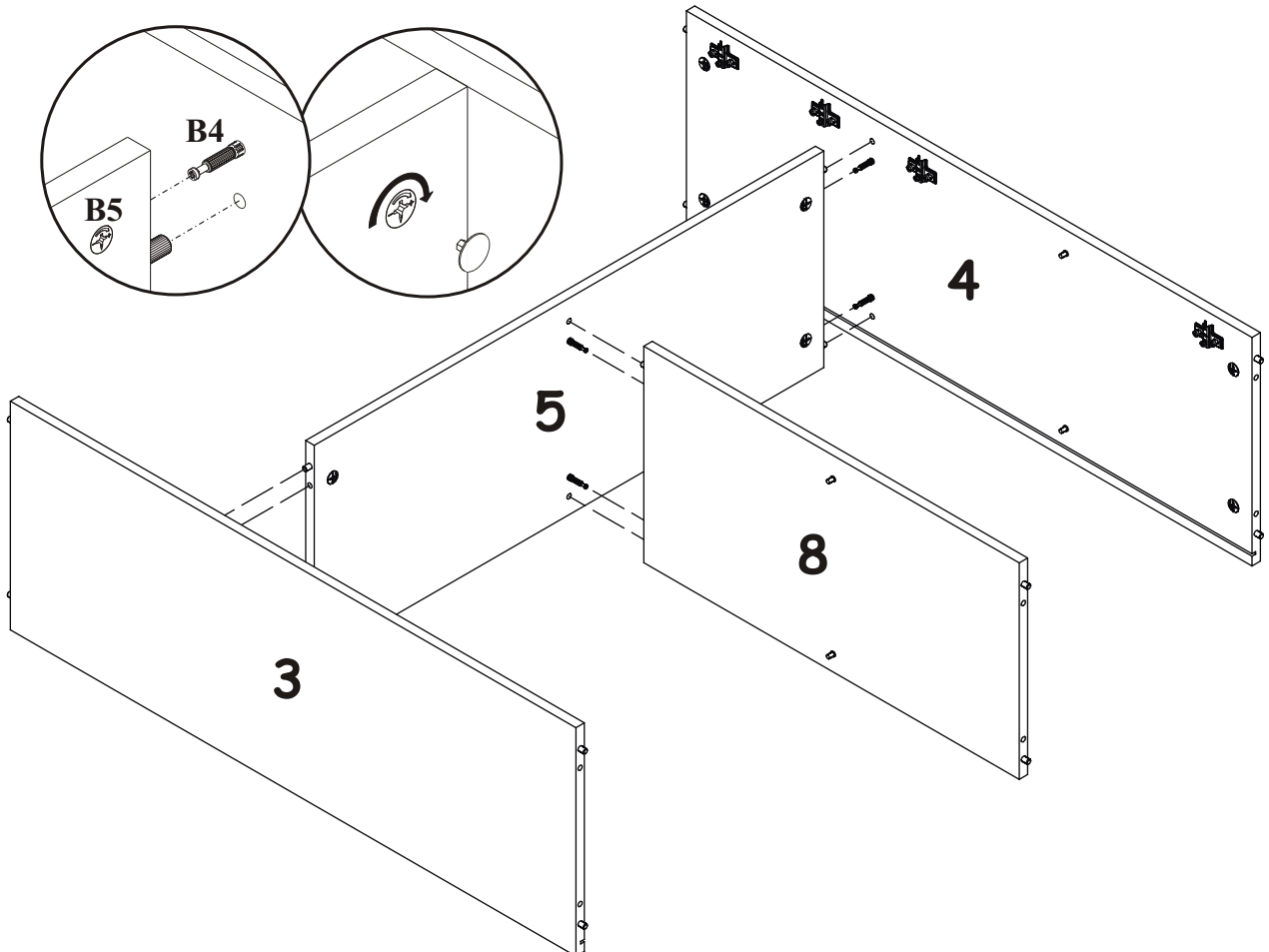

7

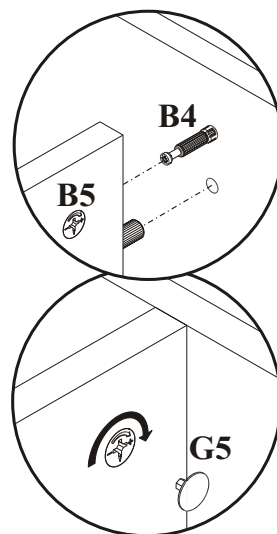
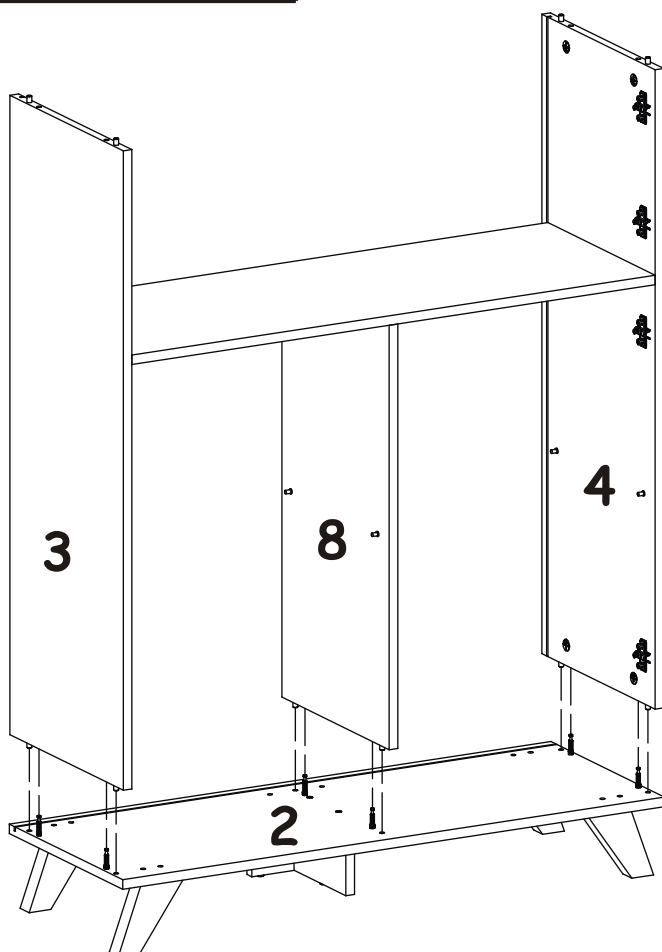

8

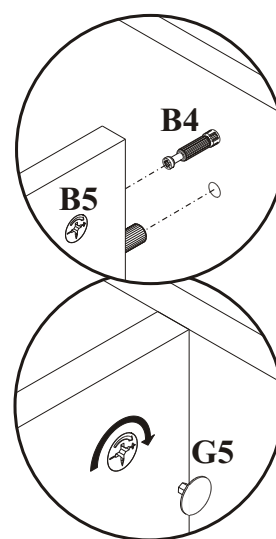
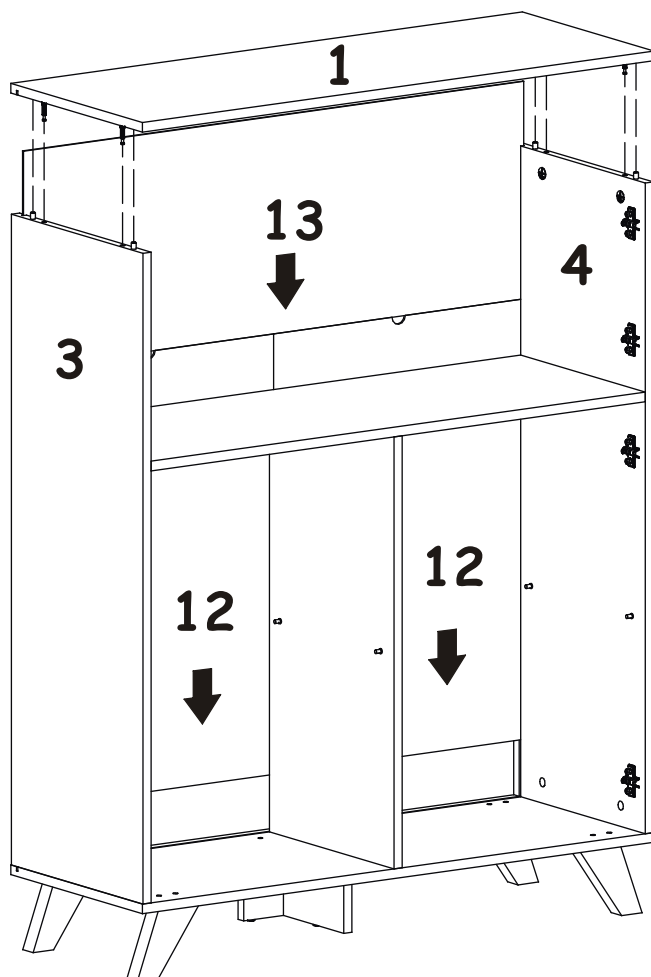

9

X=Y 

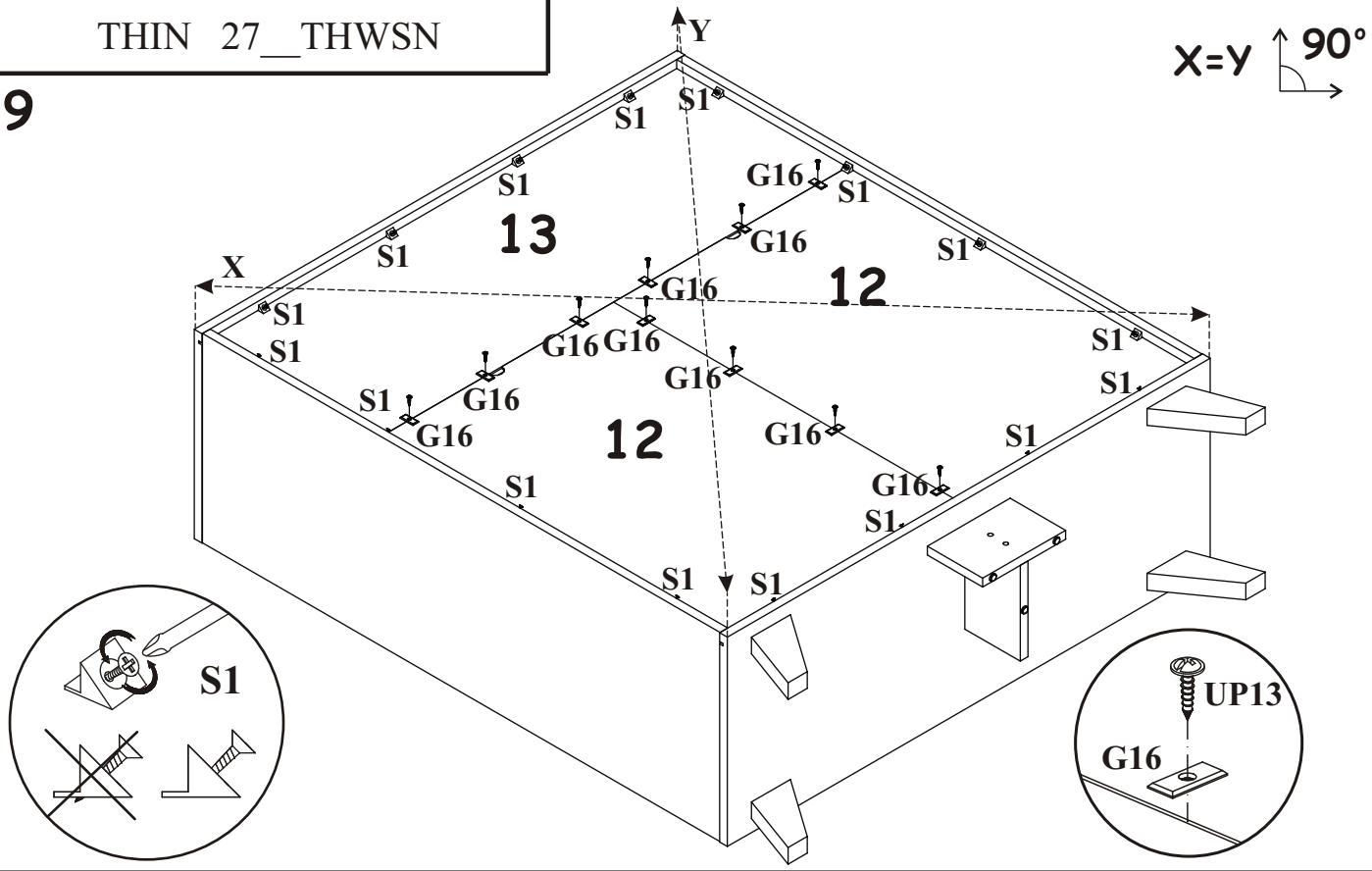

10

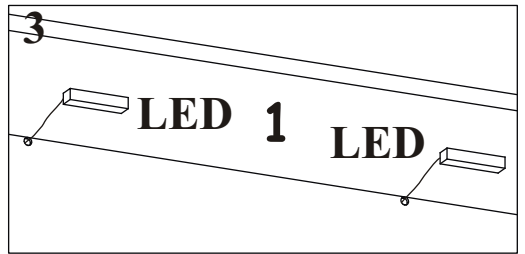
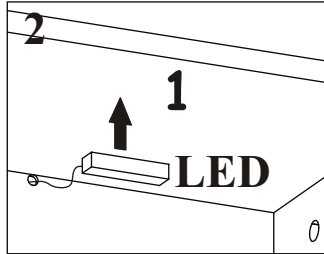
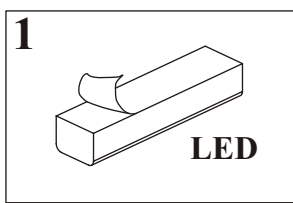
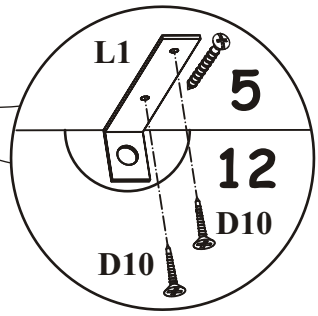
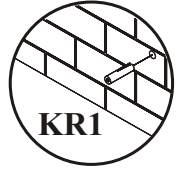
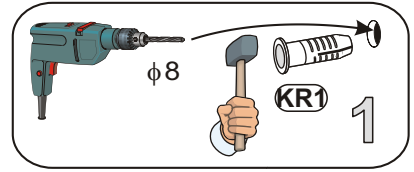
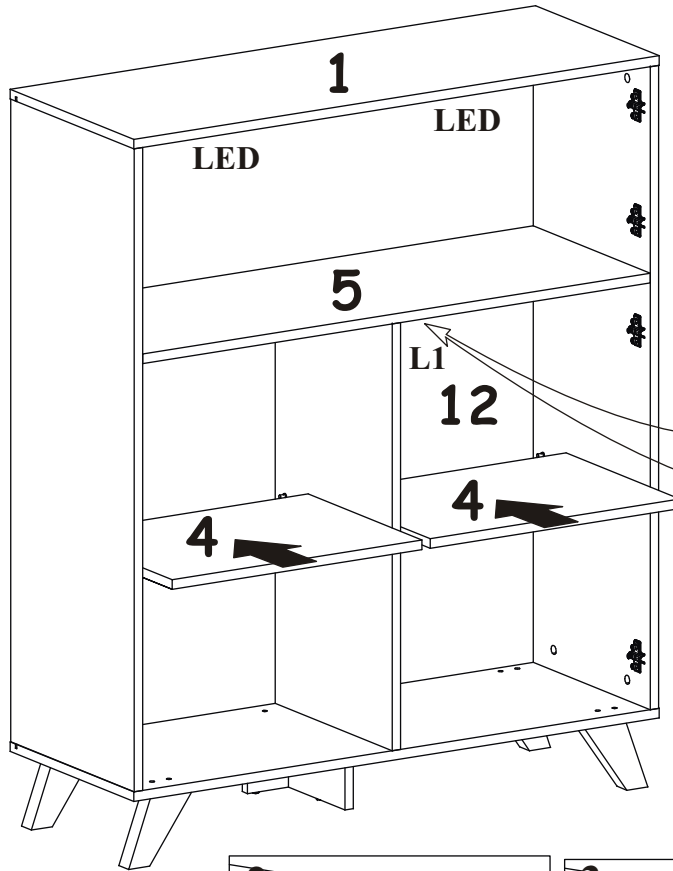
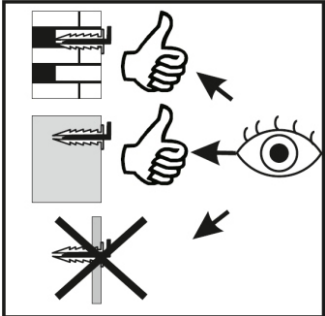

11

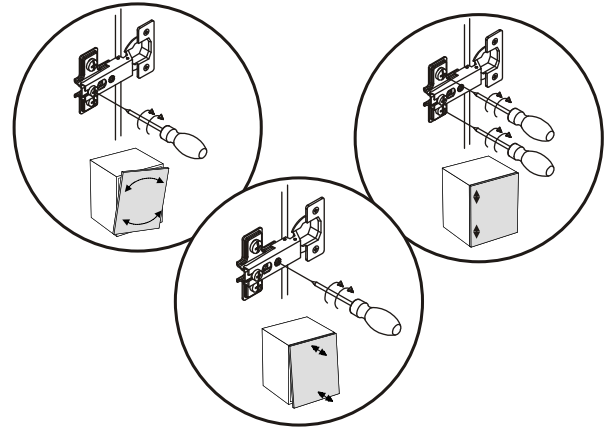
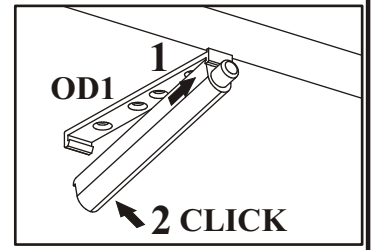
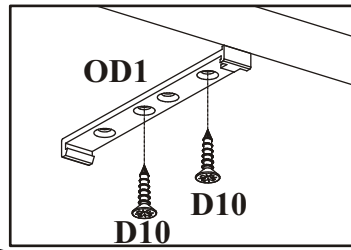
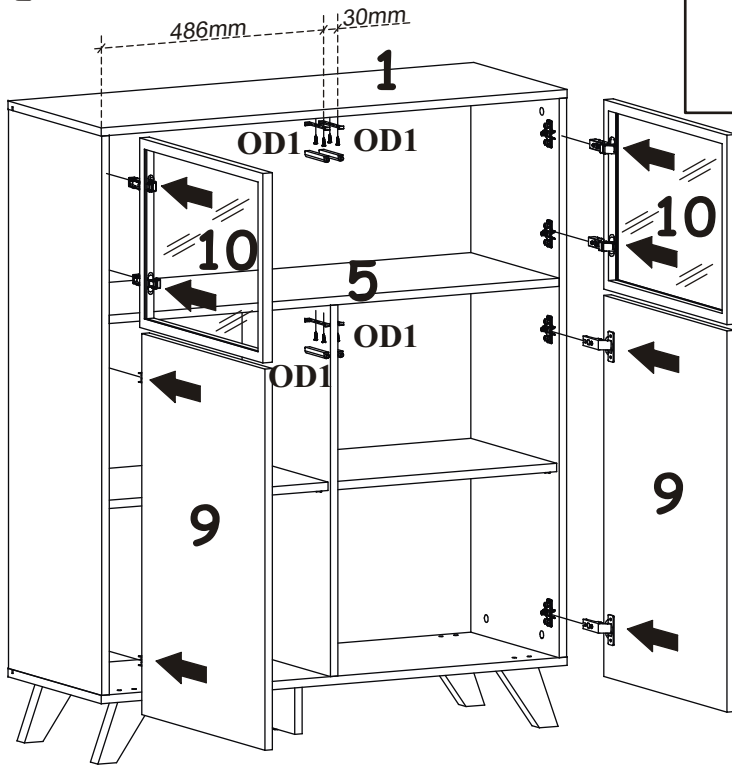

12

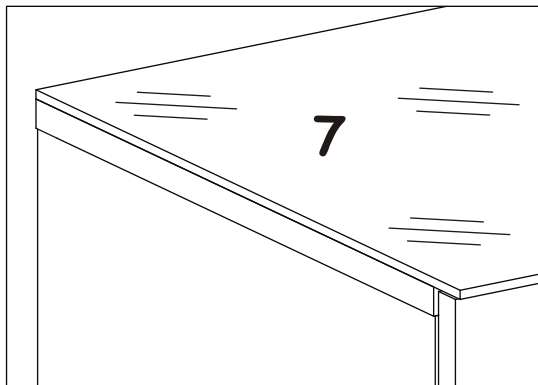
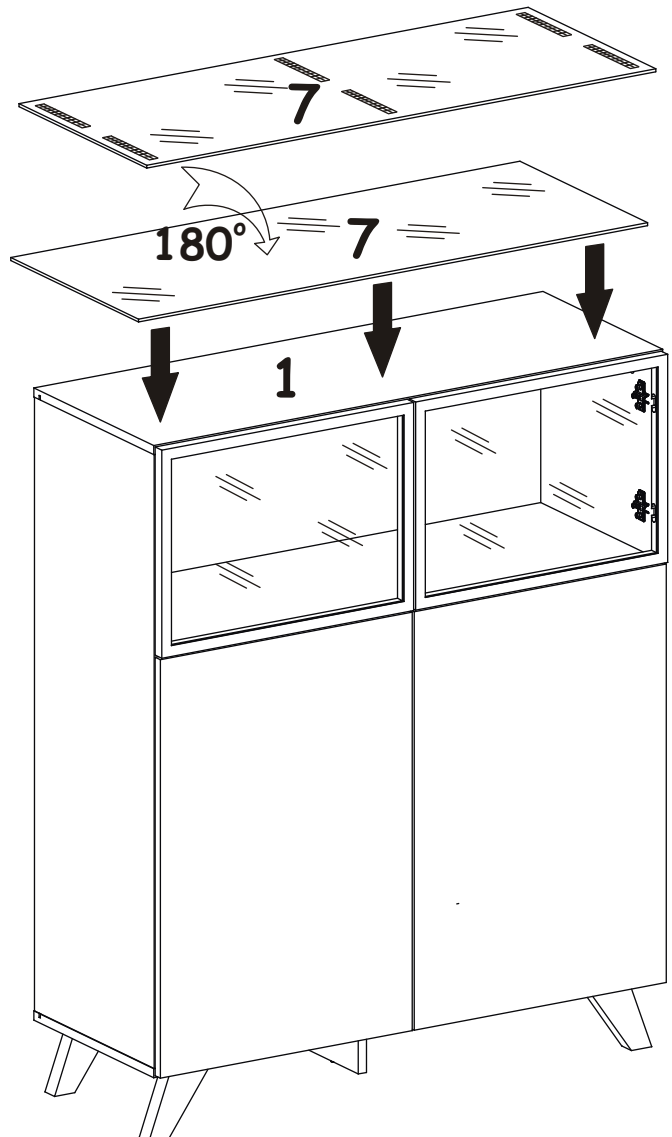
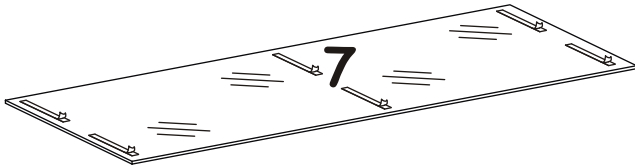
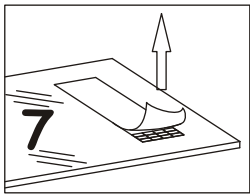

THIN 27_THWSW

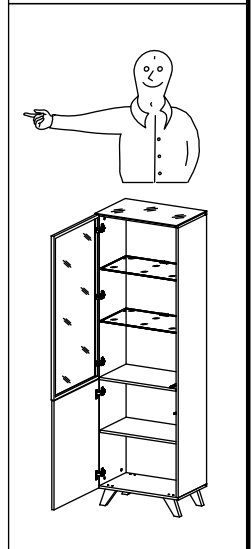
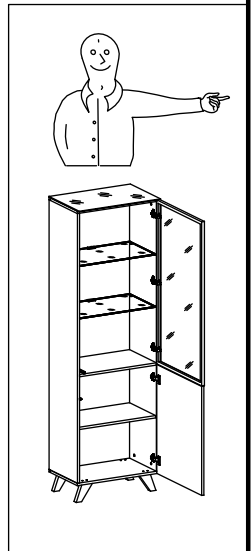
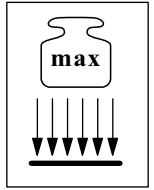
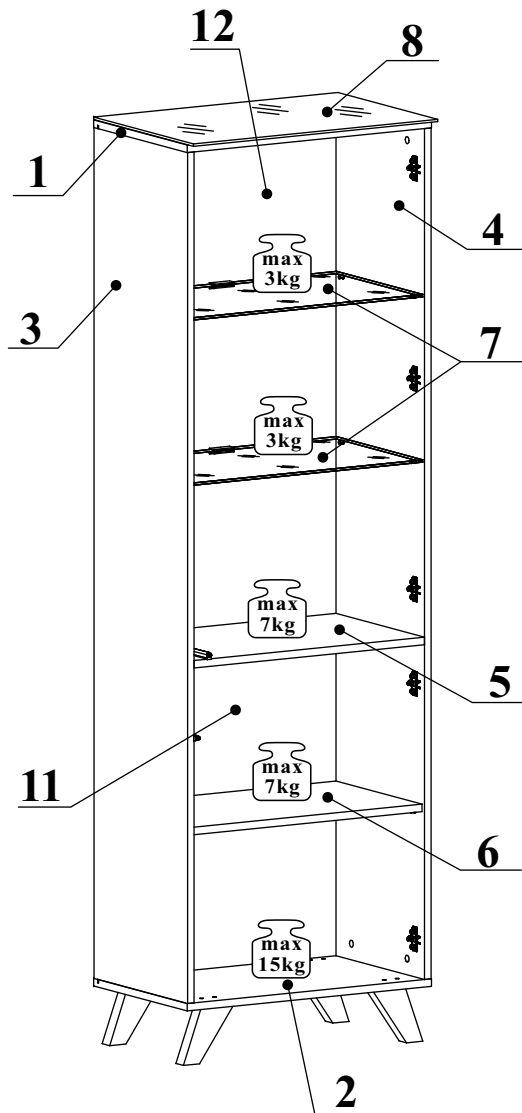
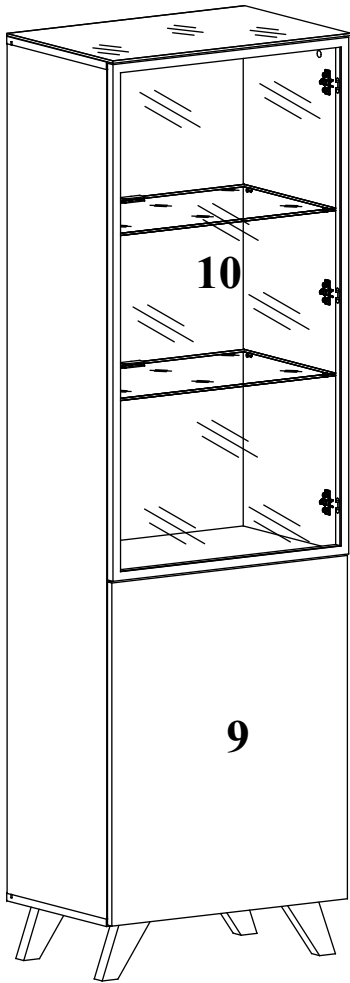



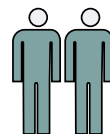
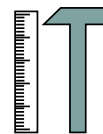





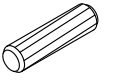
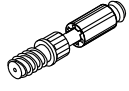



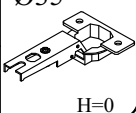
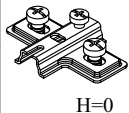

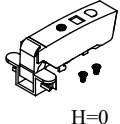
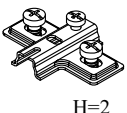
NO	Dim.		Col.-No	Qty
1	602	376	2	1
2	602	376	2	1
3	1812	376	2	1
4	1812	376	2	1
5	568	356	1	1
6	568	346	1	1
7	567	346	1	2
8	602	401	1	1
9	596	732	1	1
10	596	1102	1	1
11	580	727	1	1
12	1097	580	1	1

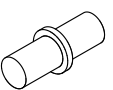
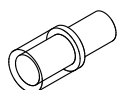
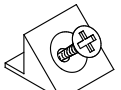
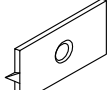

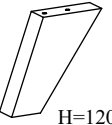
90 min

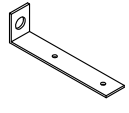
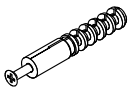
THIN 27_THWSW

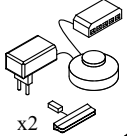
A1 x12  ø8x36	B4 x12 	B5 x12  Ø15x12	G5 x12 	B11 x8  Ø7x50	G4 x8 
E21 x2 Ø35  H=0	E2 x2  H=0	D10 x10  USØ3,5x13	E30 x3  H=0	E4 x3  H=2	Z2 x10  Ø5
G7 x4 	G20 x8 	S1 x16 	G16 x4 	UP13 x4  UPØ3x16	SK x4  H=120
OD1 x2 	L1 x1 	KR1 x1 	G2 x1 	LED x1  x2	

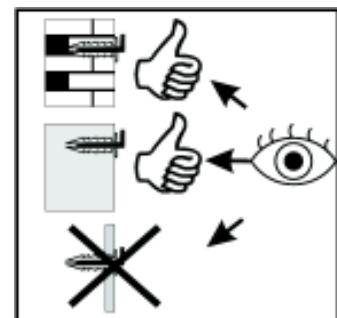
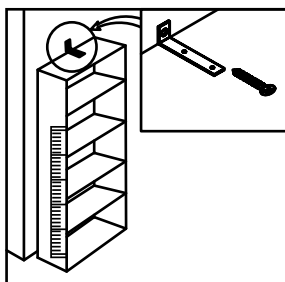
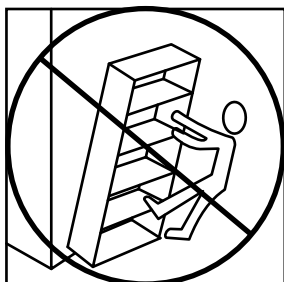
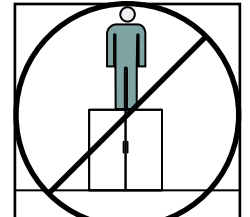
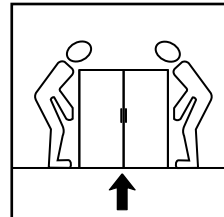
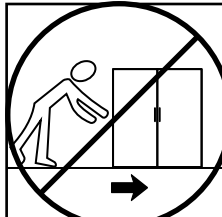
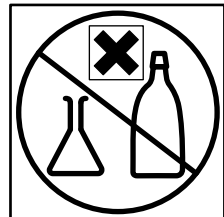
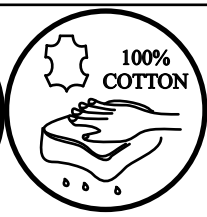
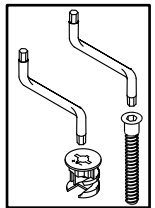
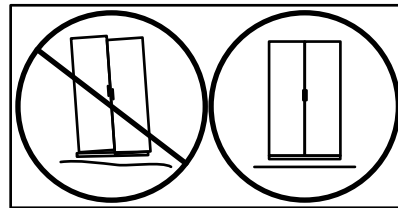
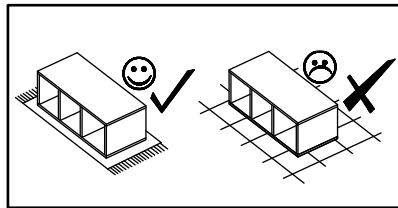
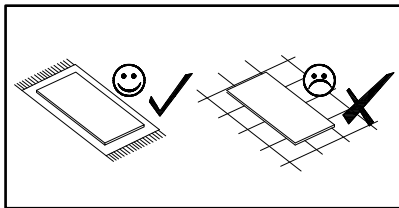
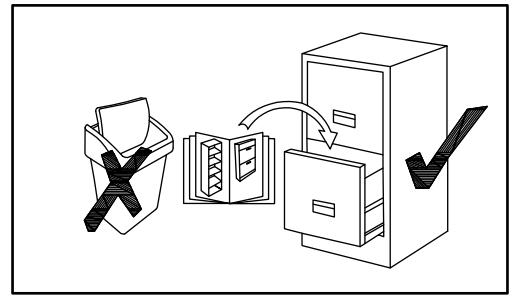
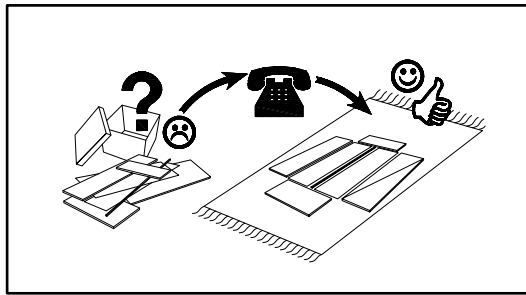
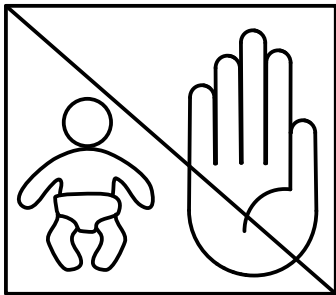
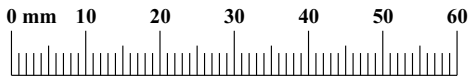

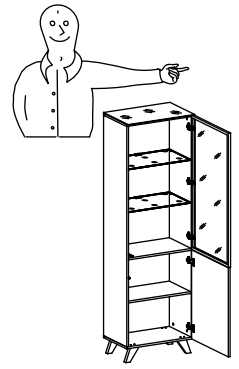

1

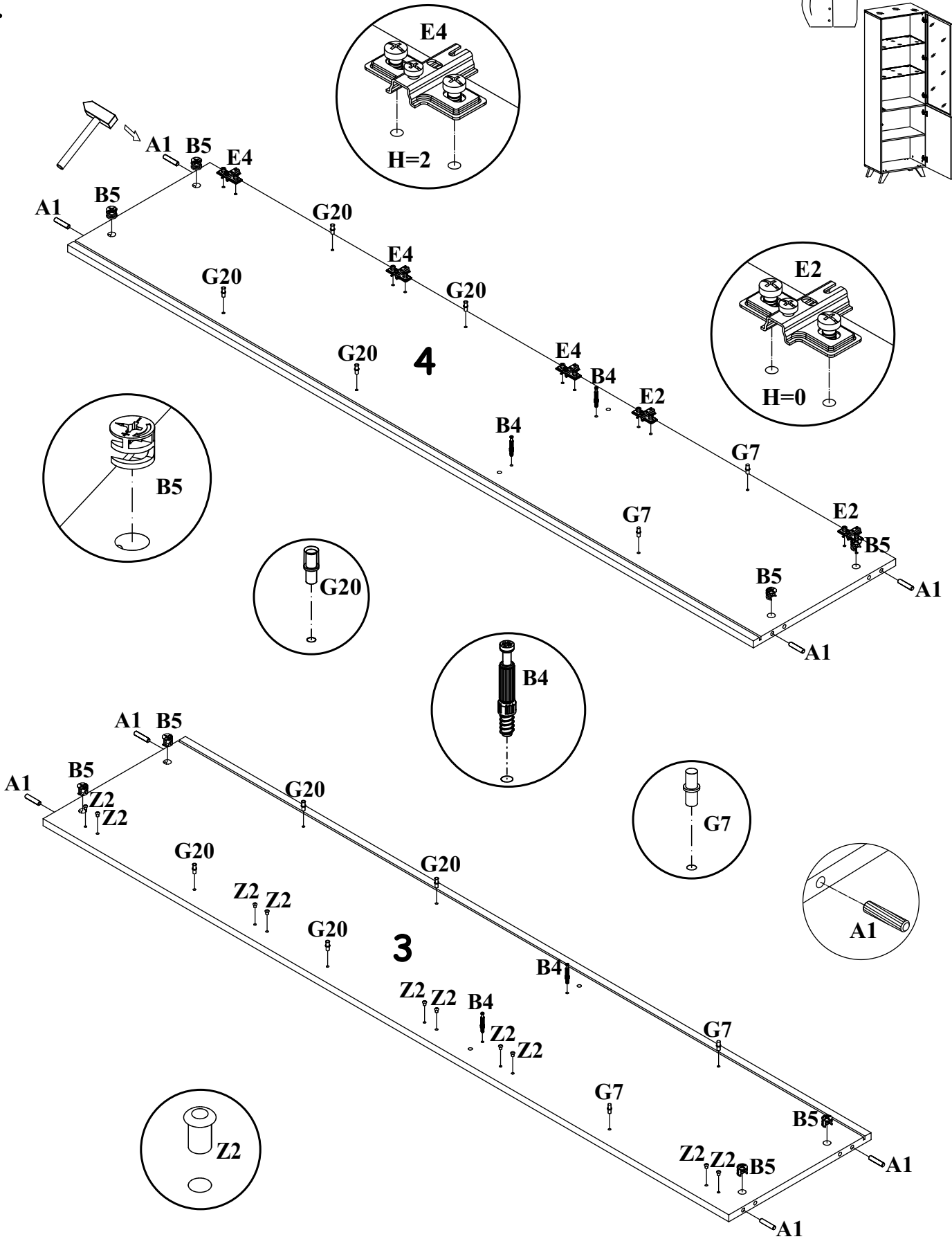

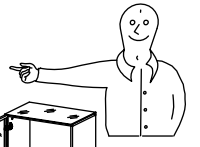

1

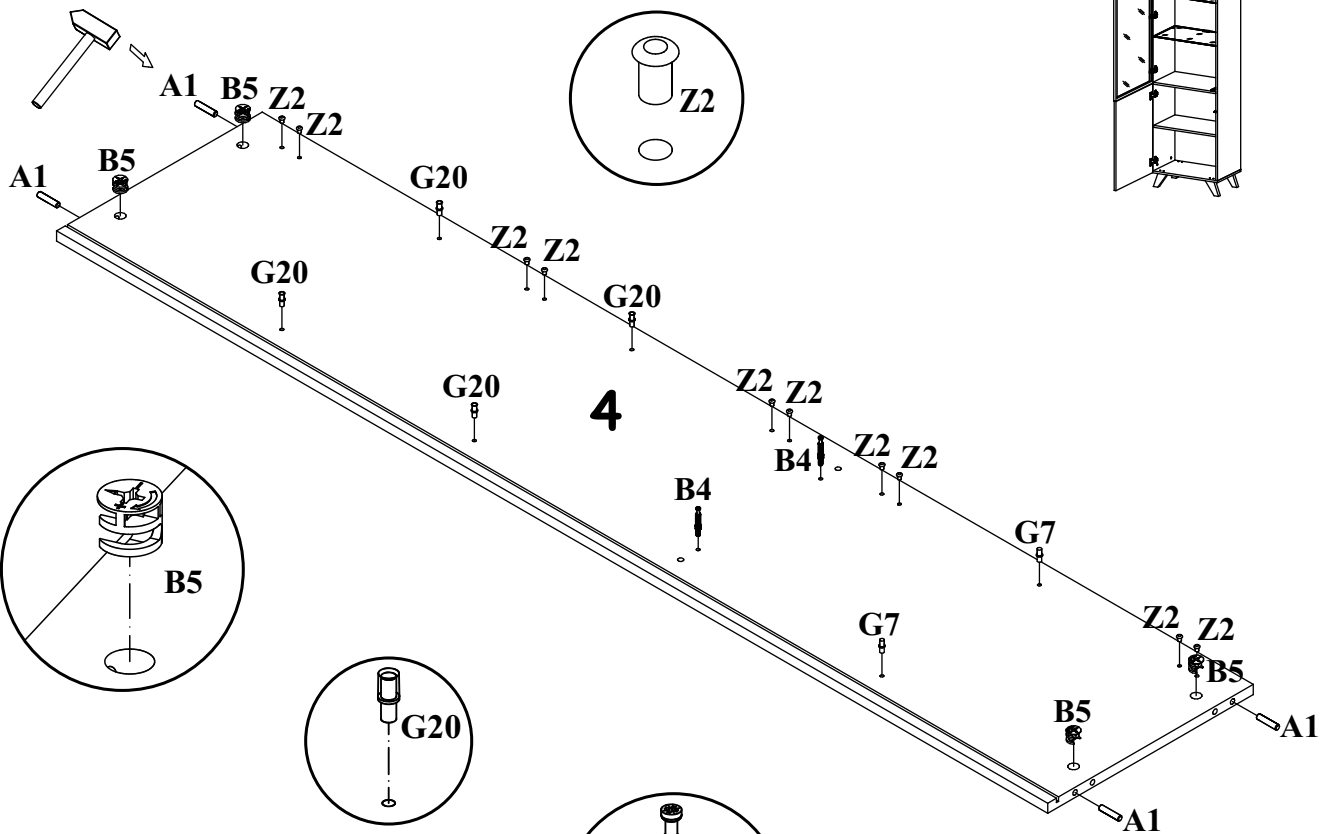

4

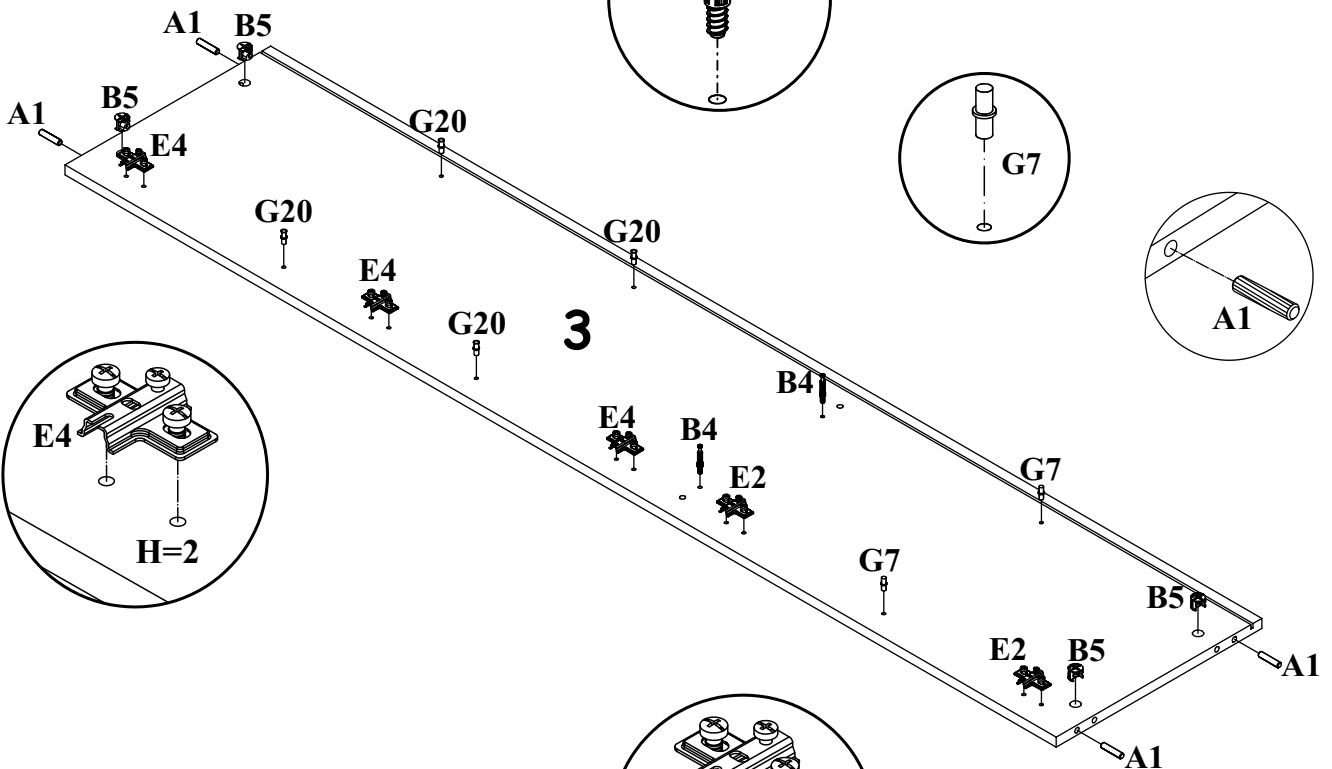
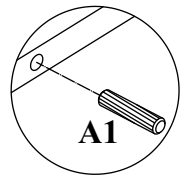
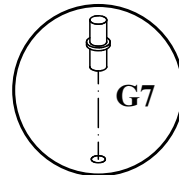
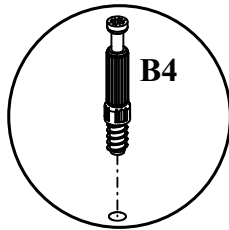
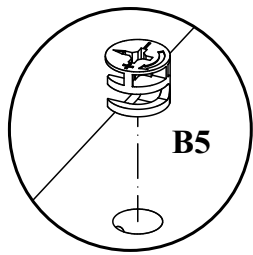

3

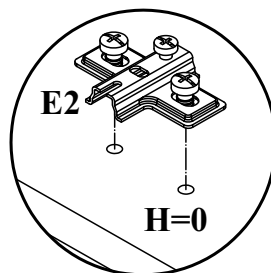
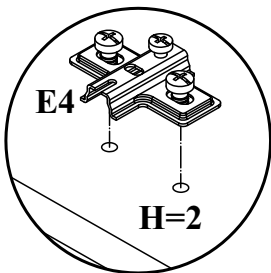

2

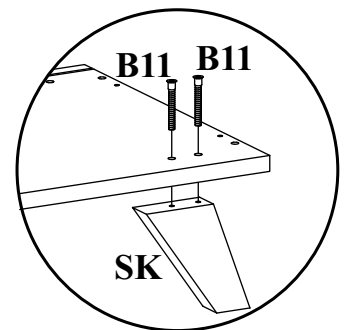
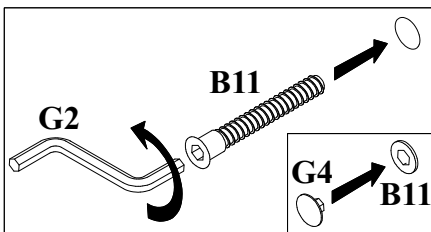
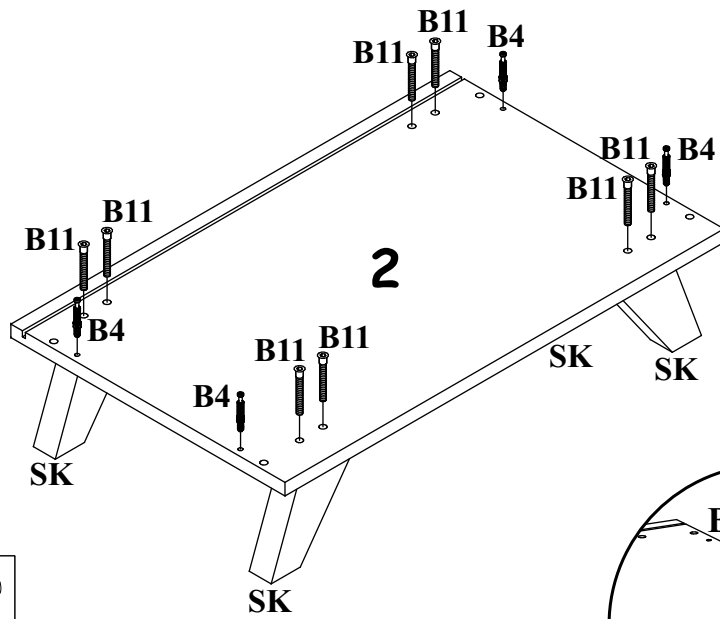
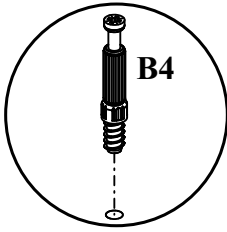
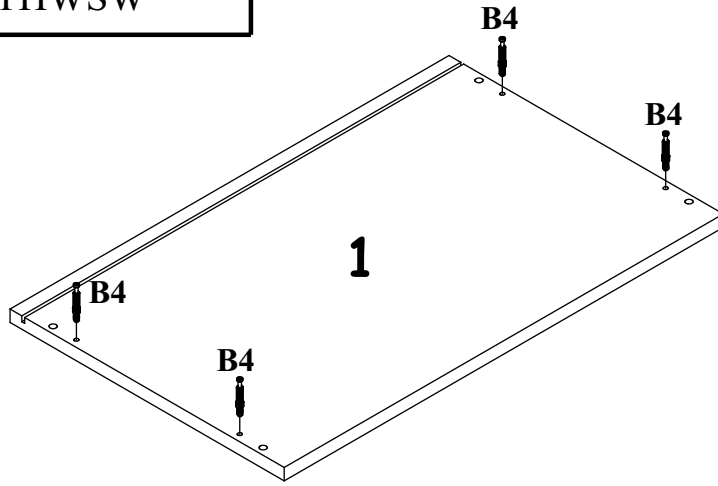

3

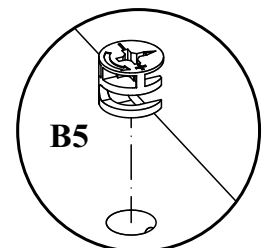
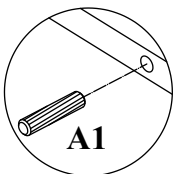
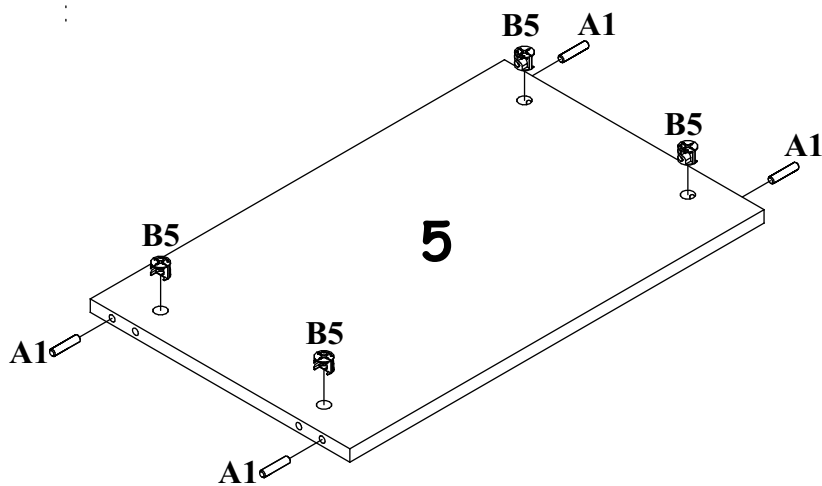

4

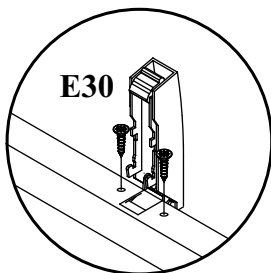
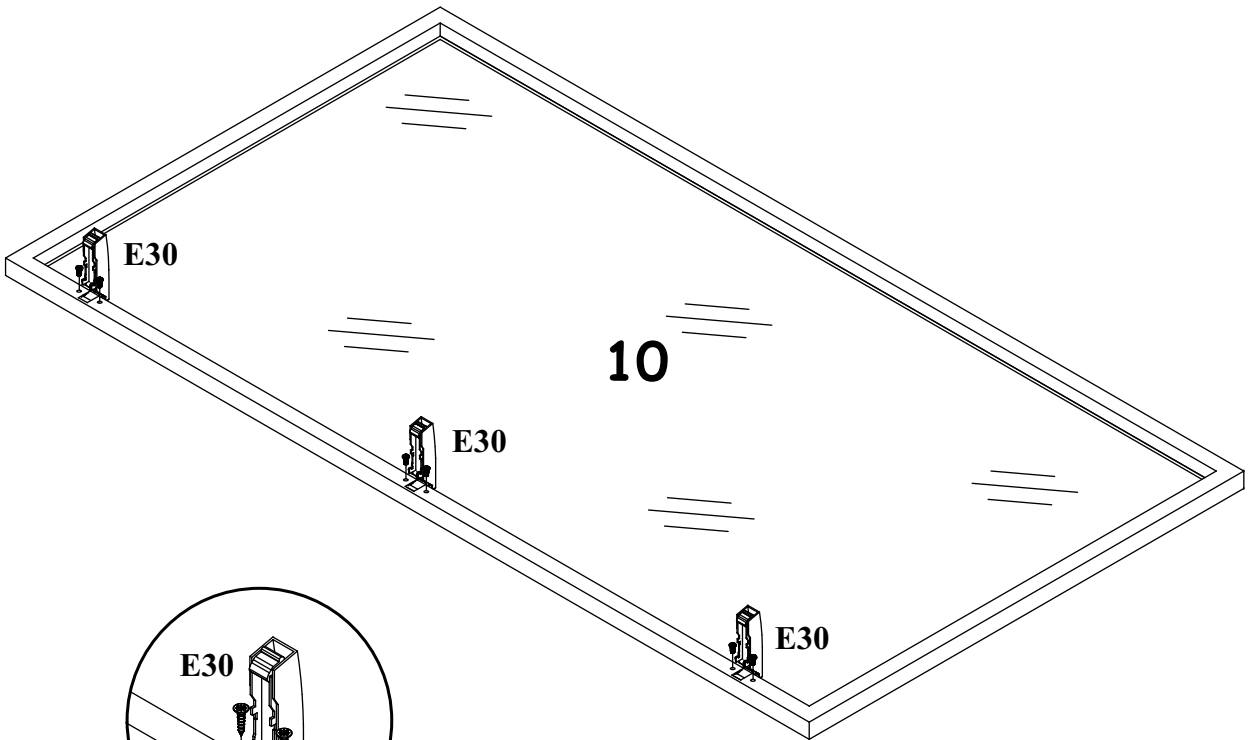
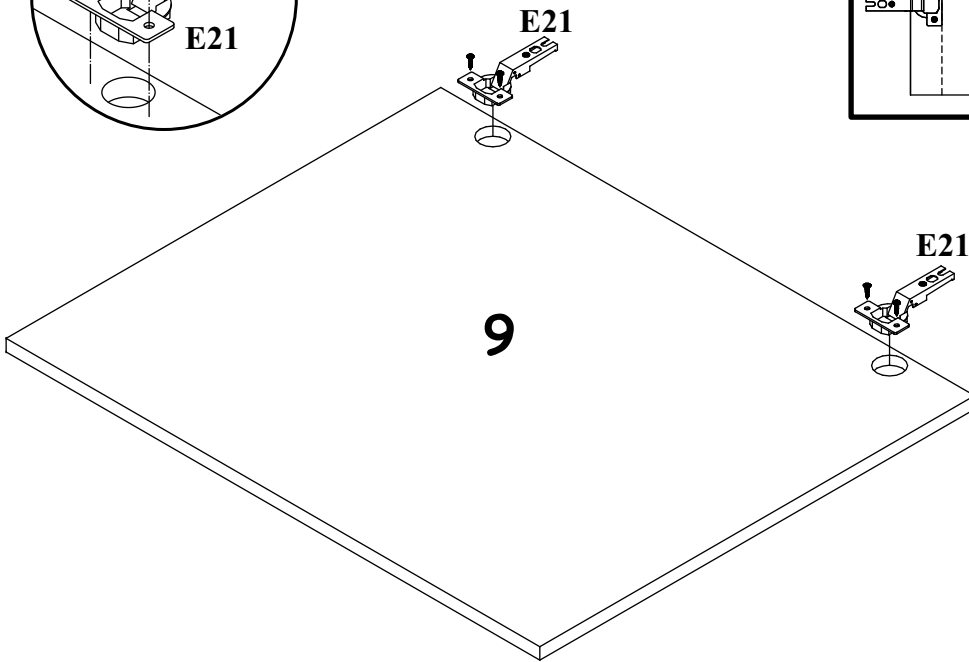
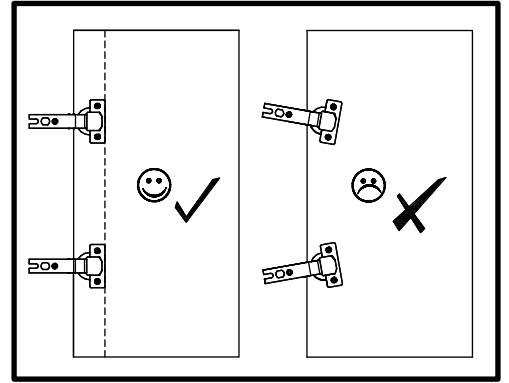
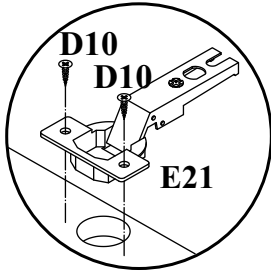

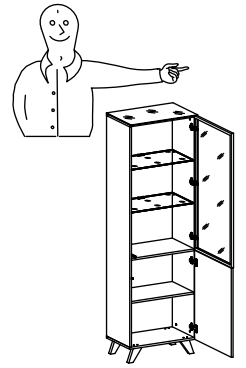

5

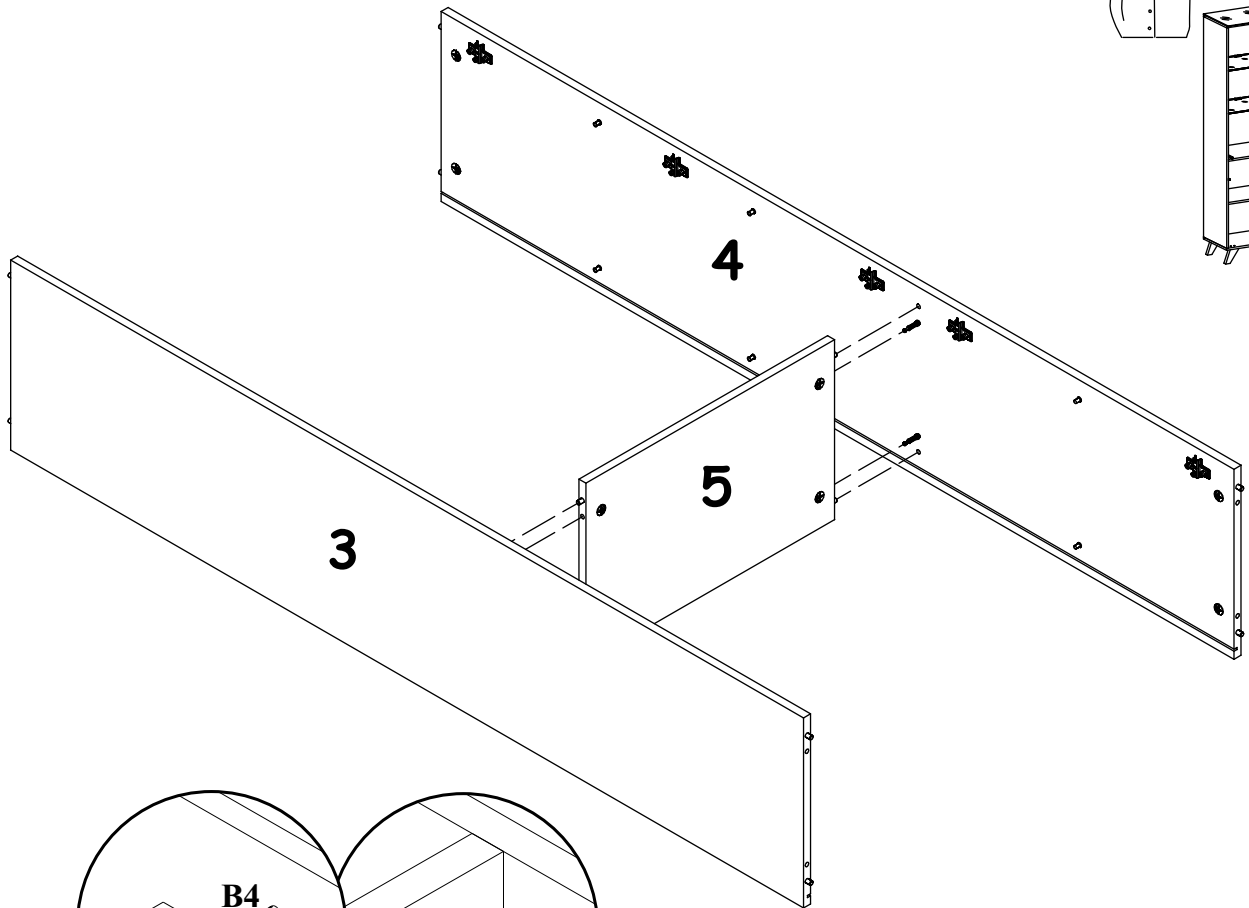

5

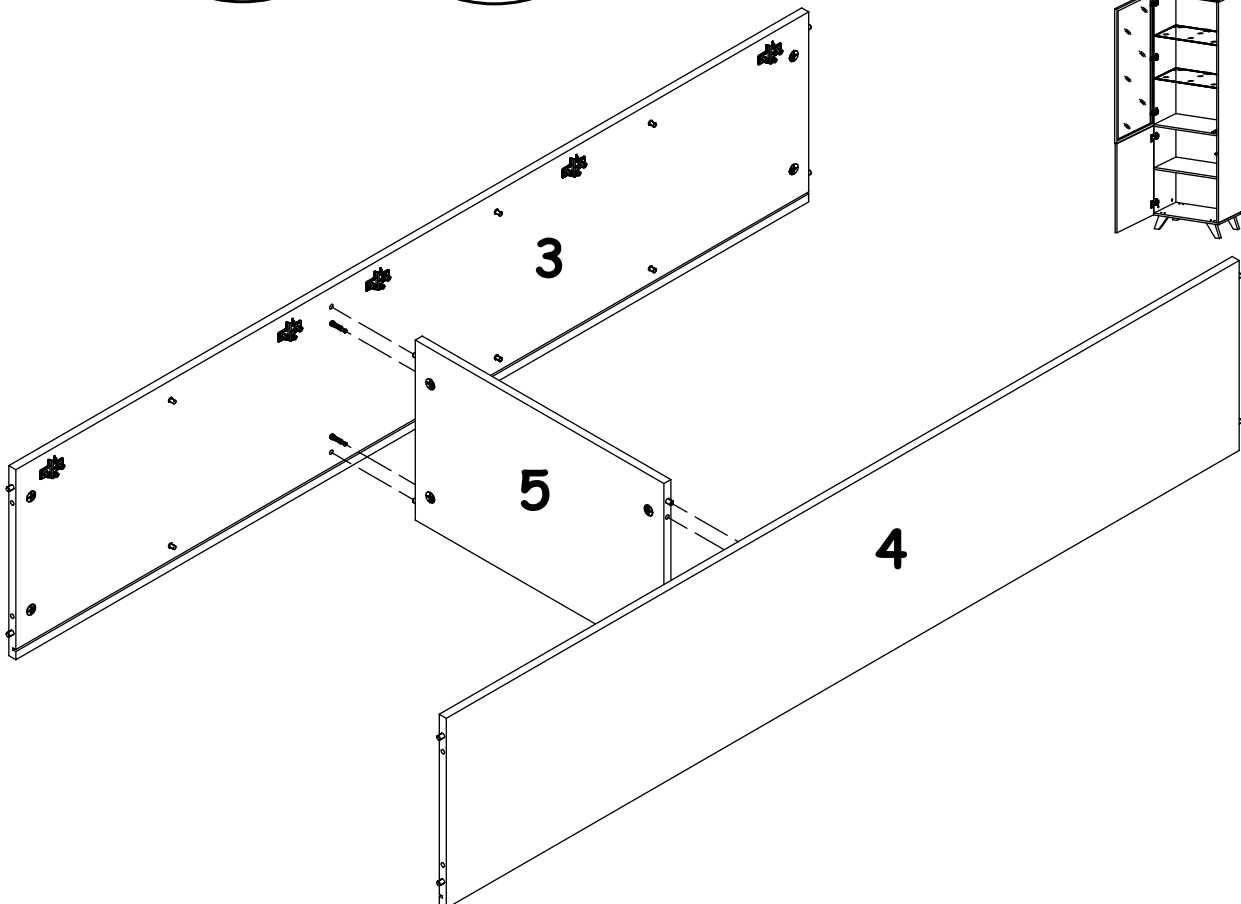
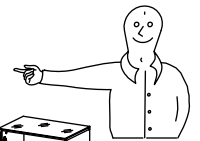
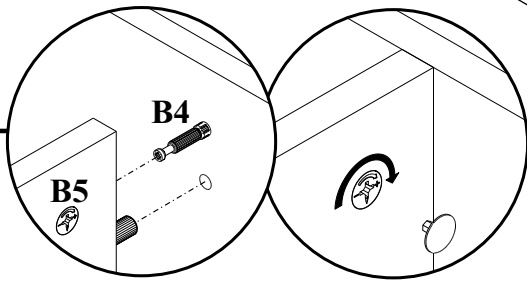

6

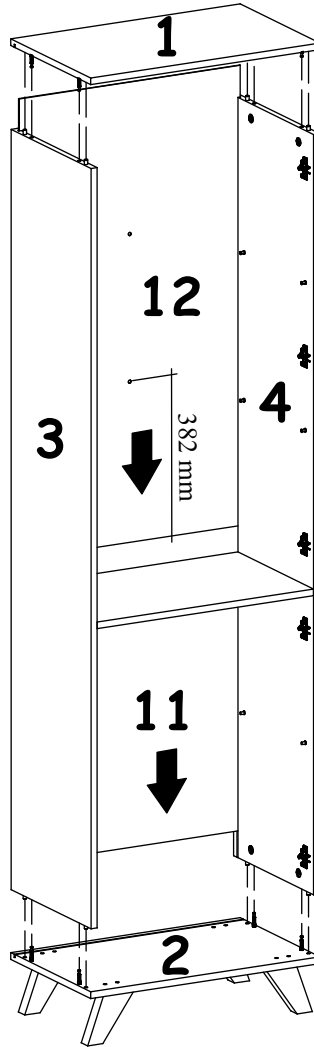
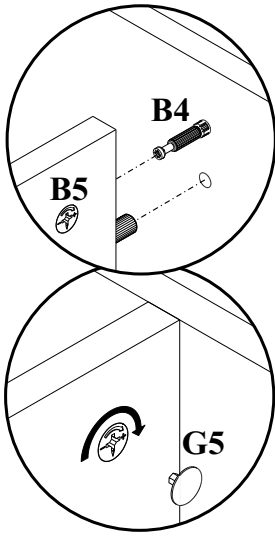

7

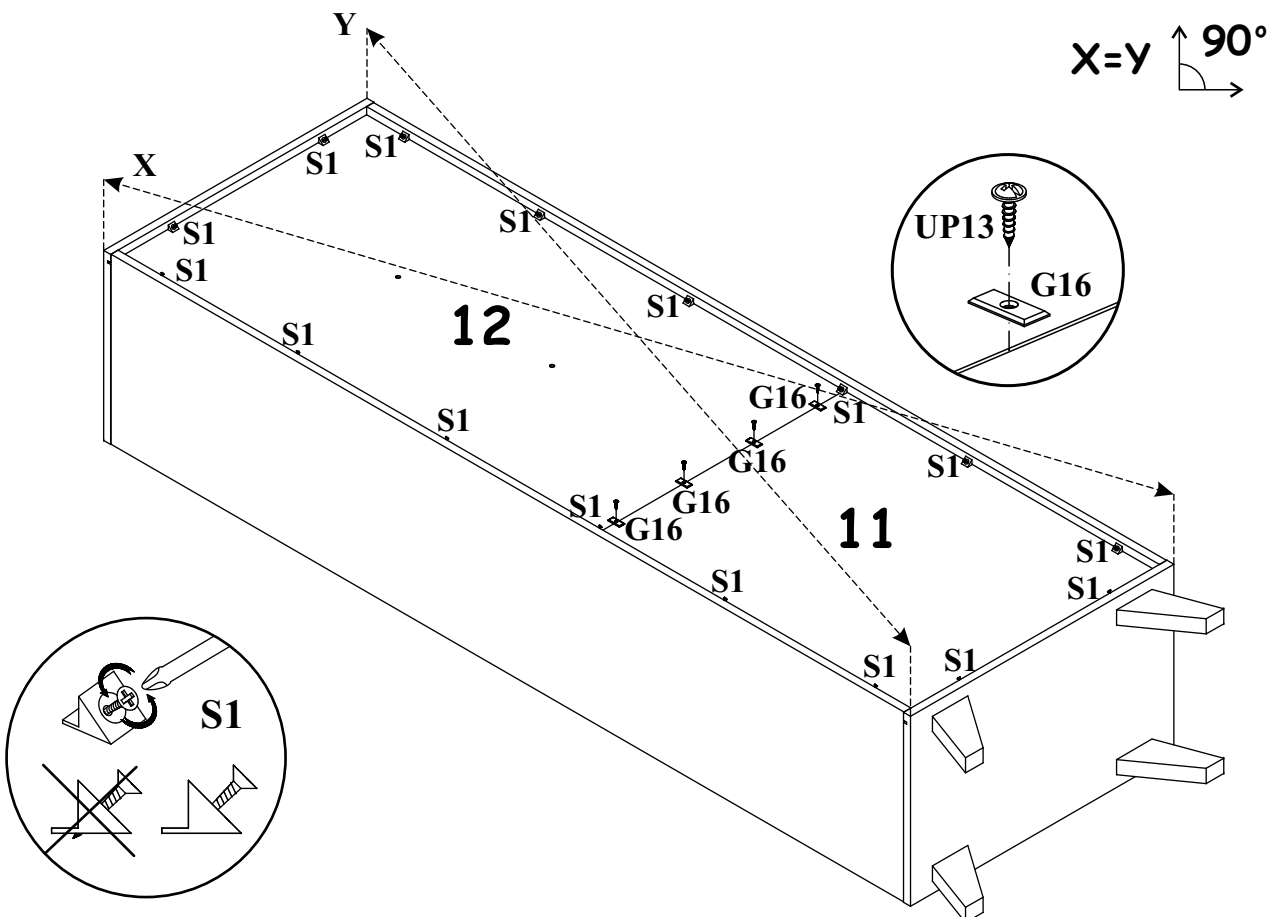

8

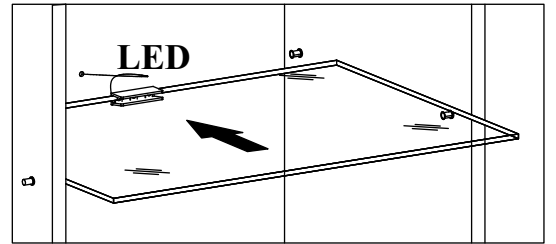
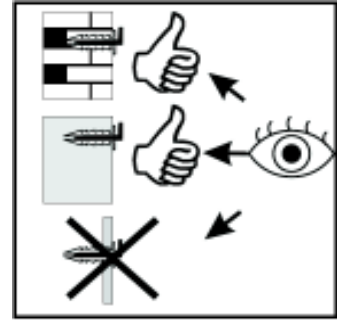
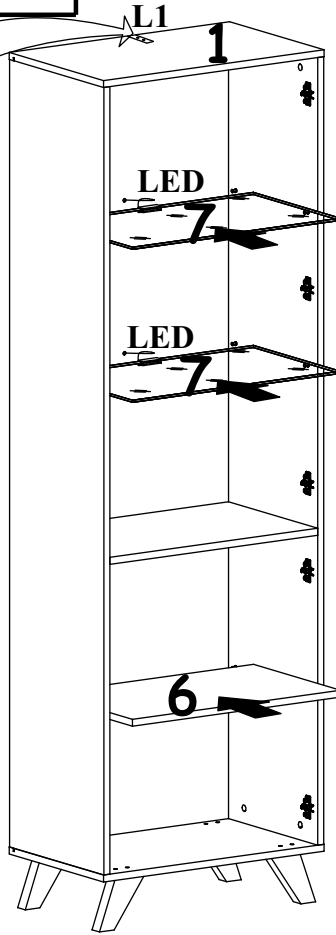
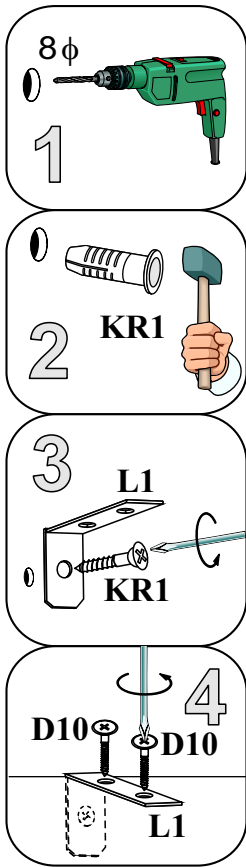

9

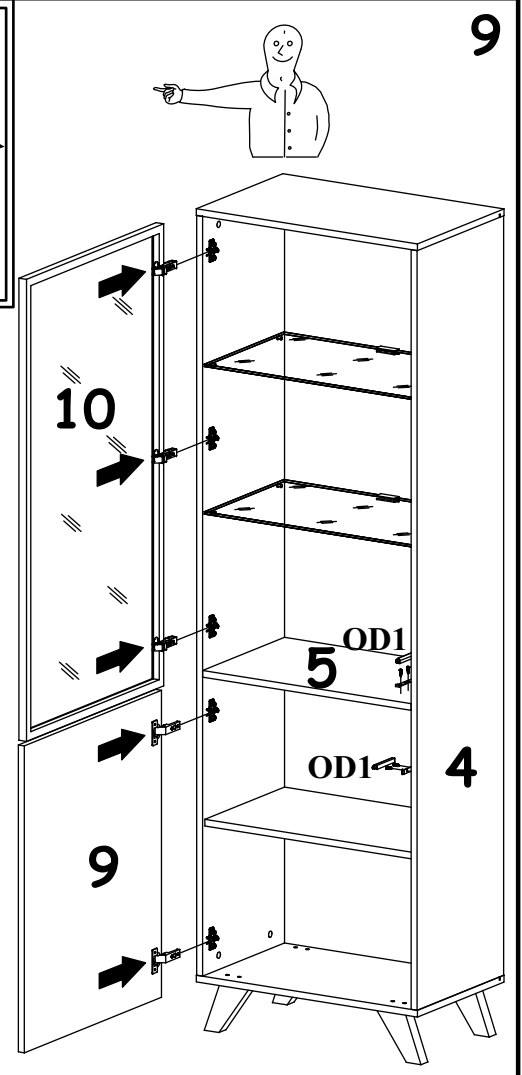
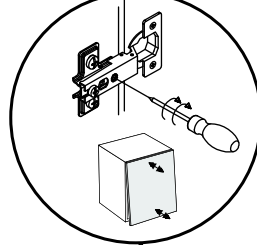
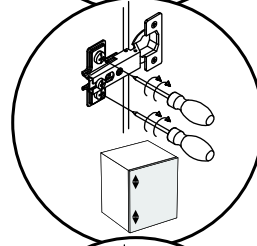
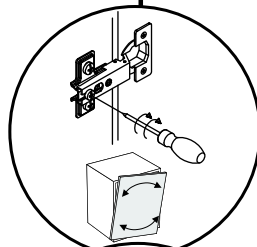
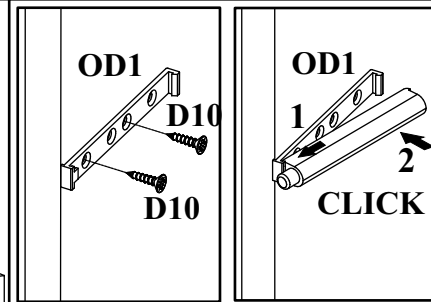
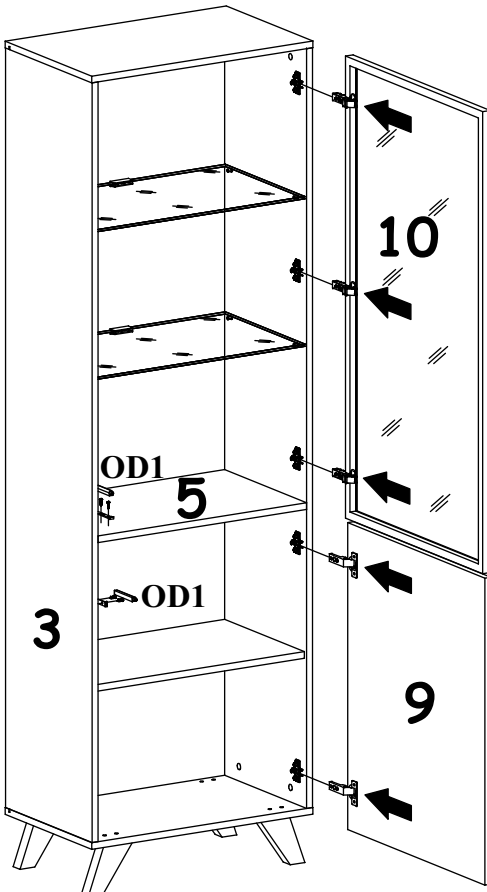
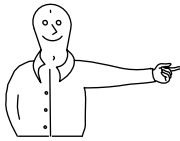

9

10

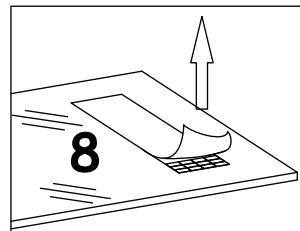
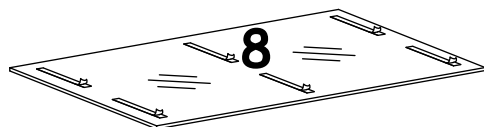

11

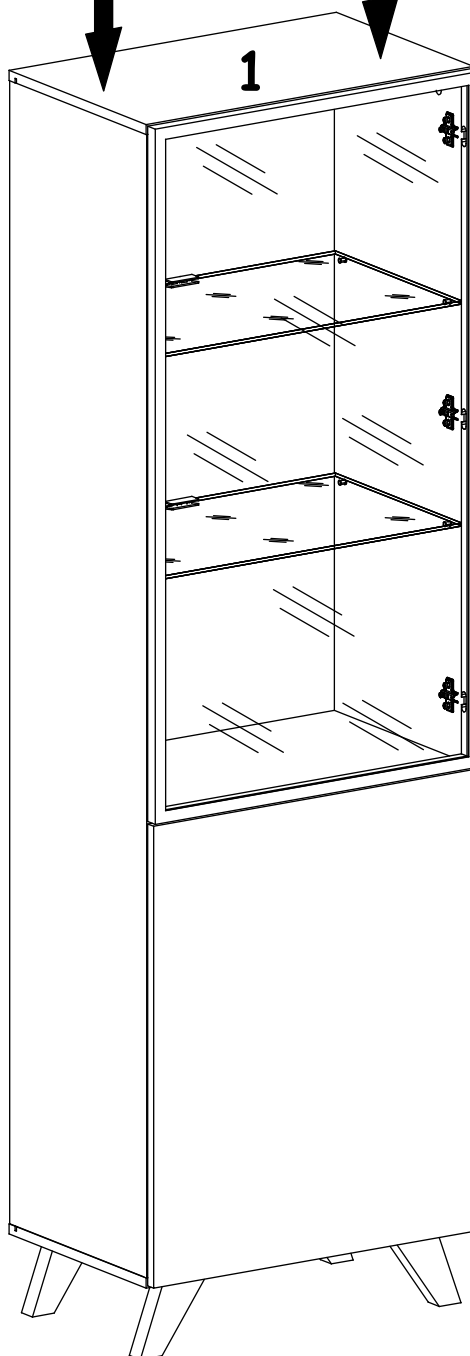
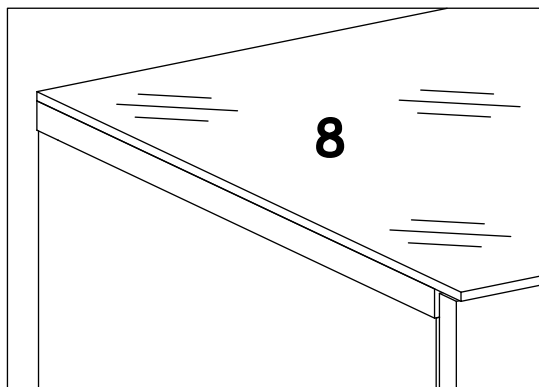
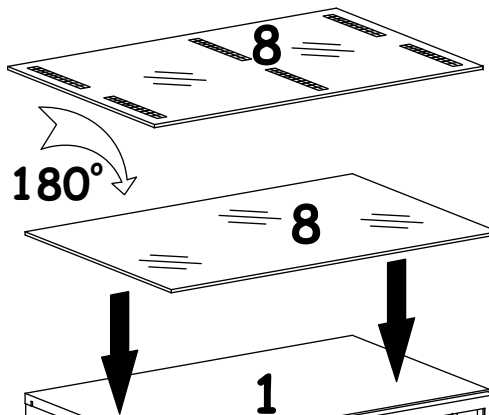

THIN 27_THTHR

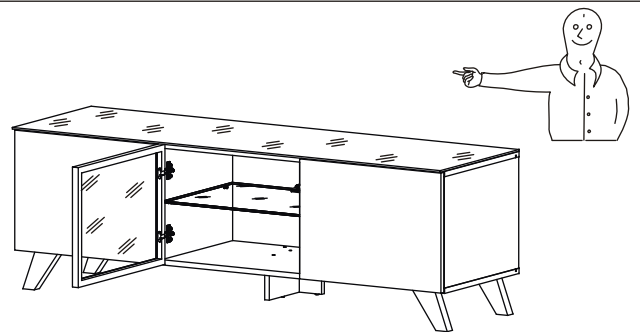
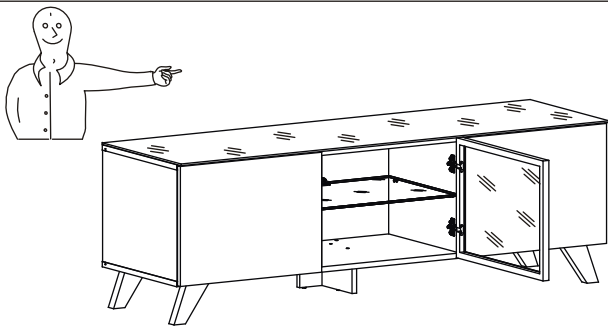
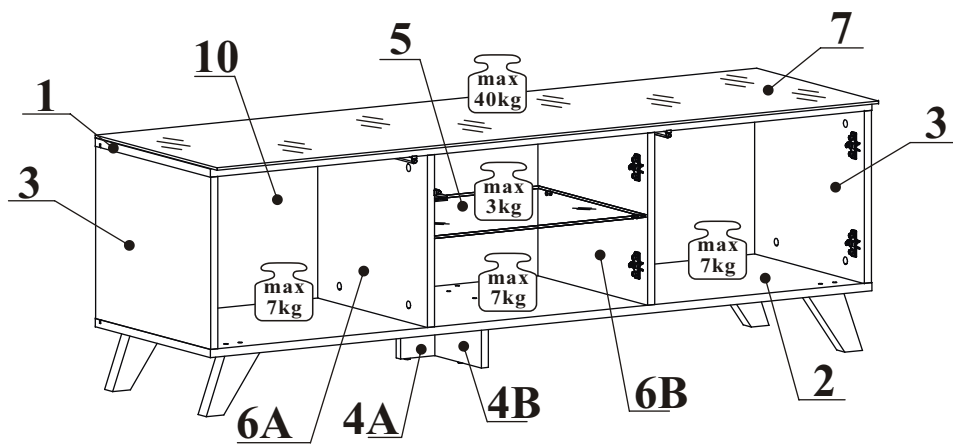
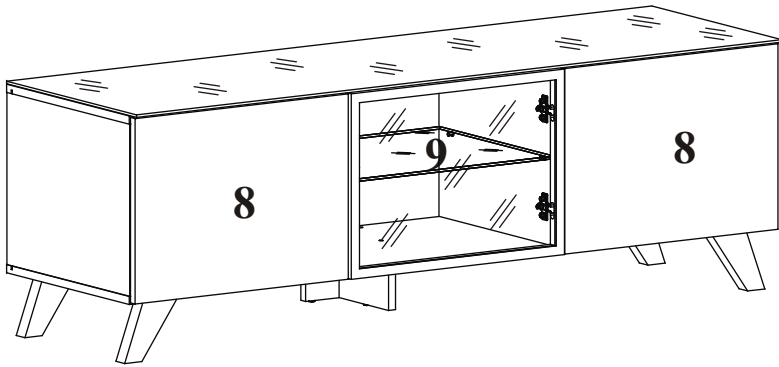
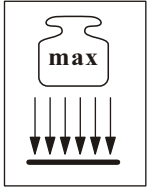



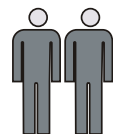
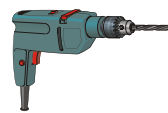





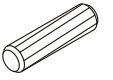
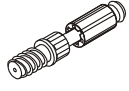

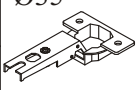
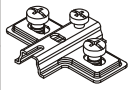
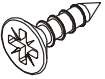
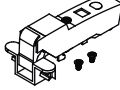
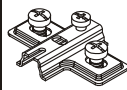

NO	Dim.		Col.-No	Qty
1	1502	426	2	1
2	1502	426	2	1
3	338	426	1	2
4A	115	172	1	1
4B	115	172	1	1
5	483	396	2	1
6A / 6B	338	406	1	2
7	1502	451	2	1
8	496	364	2	2
9	496	364	2	1
10	1480	350	2	1

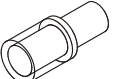

120 min

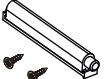
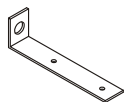
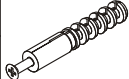
THIN 27_THTHR

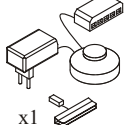
A1 x16  ø8x36	B4 x16 	B5 x16  Ø15x12	G5 x16 	B11 x14  Ø7x50	G4 x14 
E21 x4 Ø35  H=0	E2 x4  H=0	D10 x16  USØ3,5x13	E31 x2  H=8	E4 x2  H=2	Z2 x4  Ø5
G20 x4 	S1 x14 	UP13 x6  UPØ3x16	SK x4  H=120	I2 x3 	OD1 x3 
L1 x1 	KR1 x1 	G2 x1 	LED x1 		

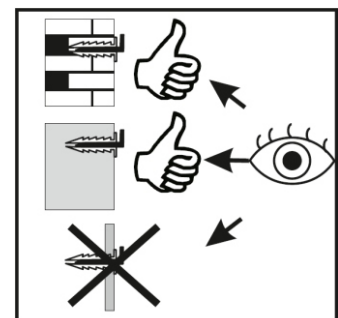
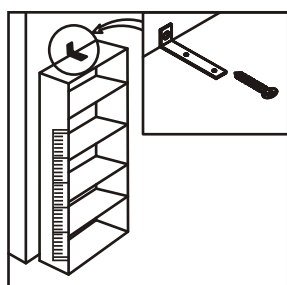
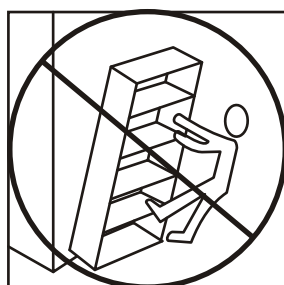
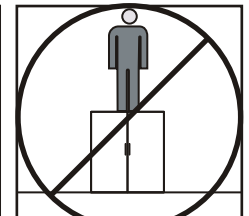
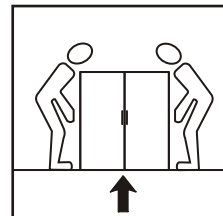
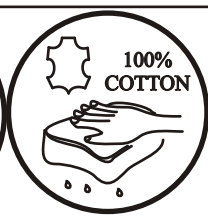
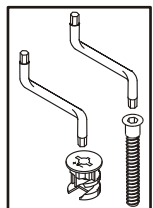
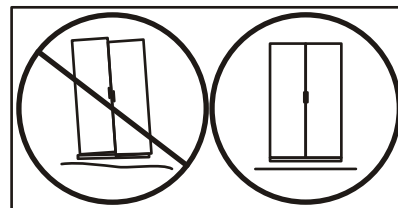
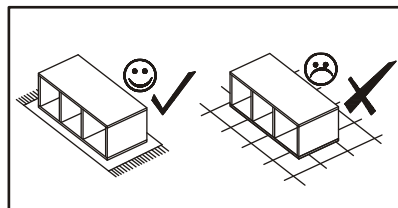
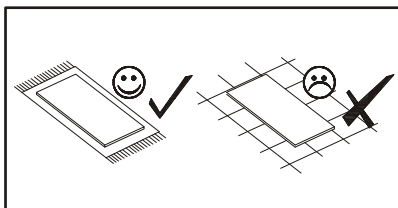
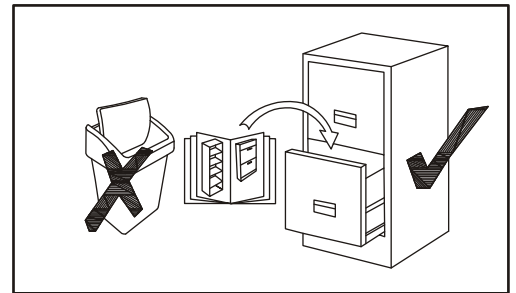
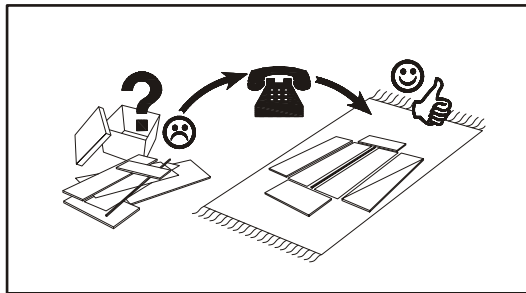
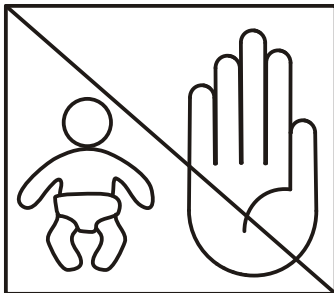
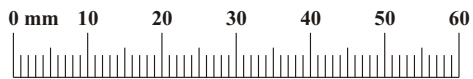

1

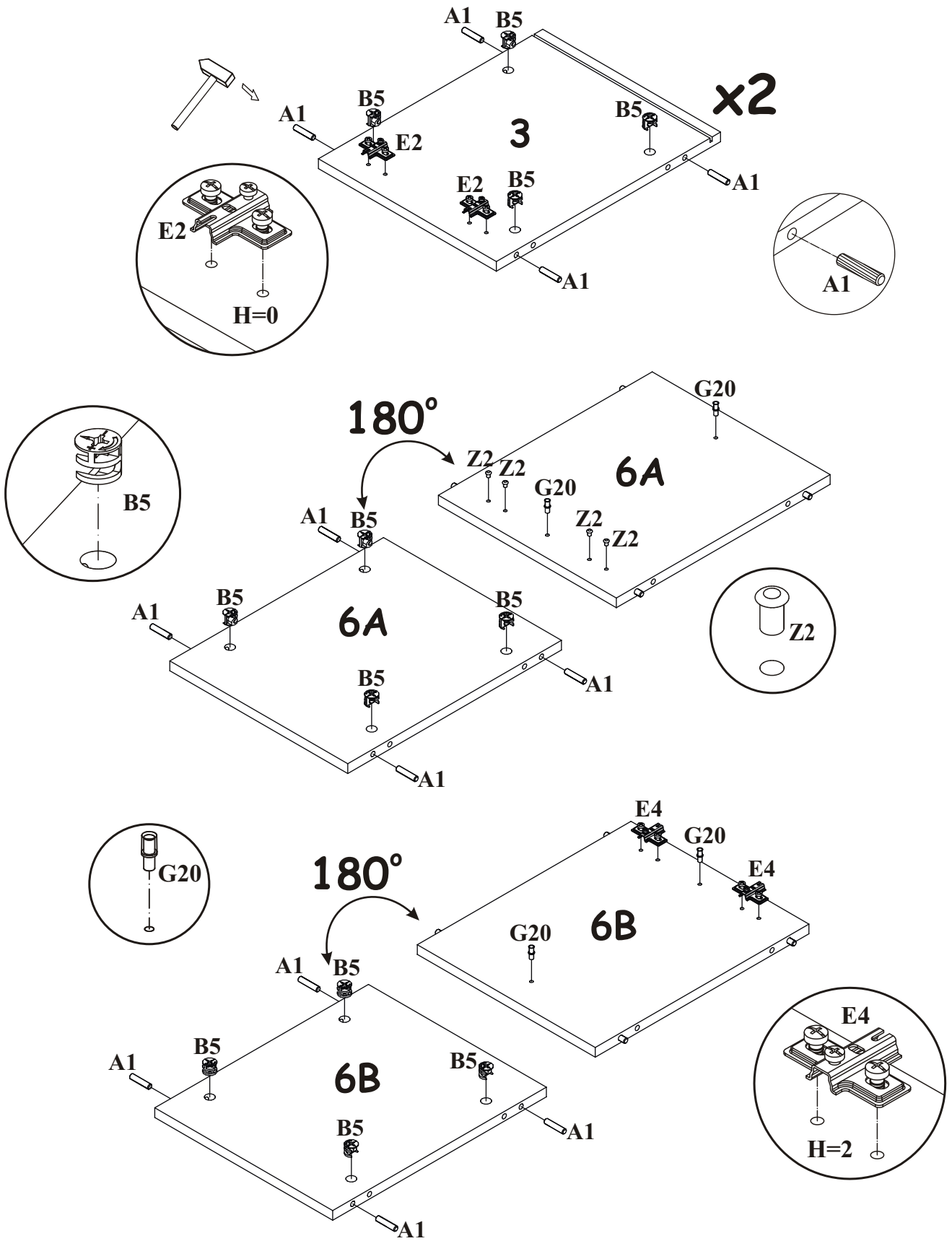

2

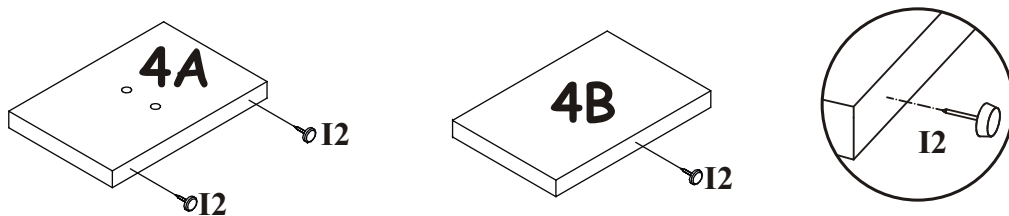

3

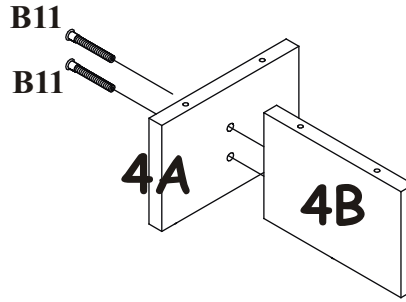
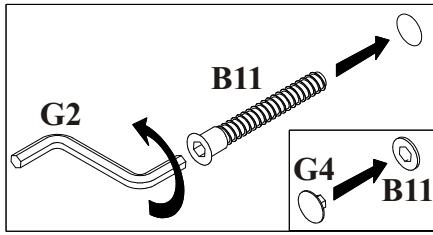

4

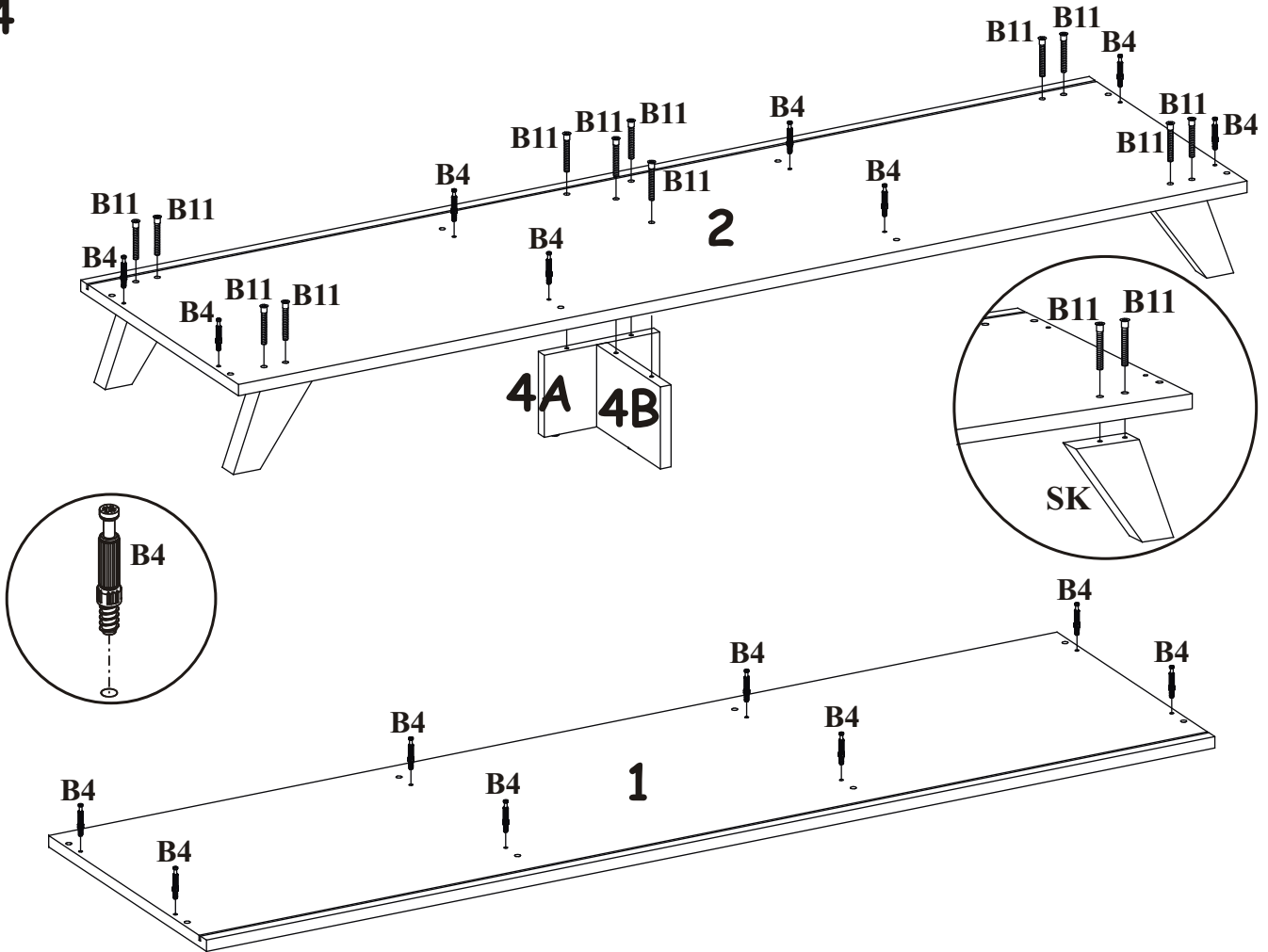

5

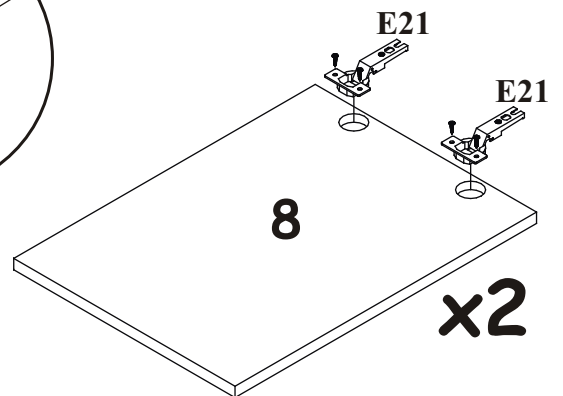
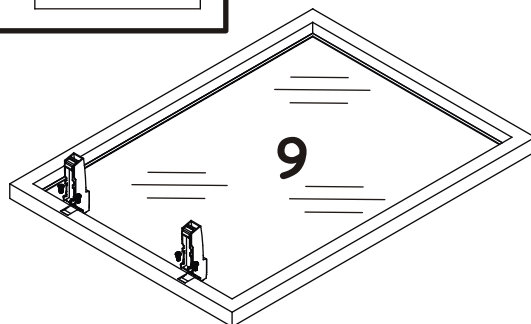
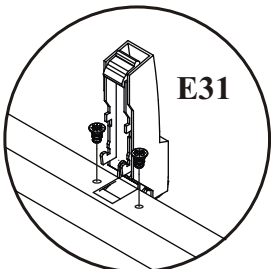
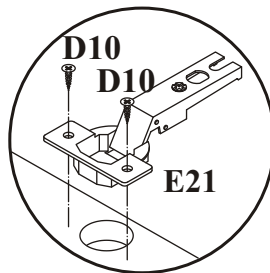
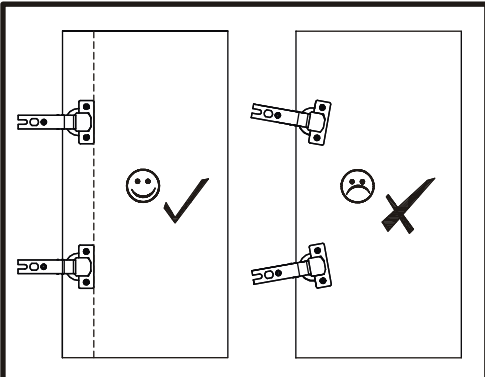

6

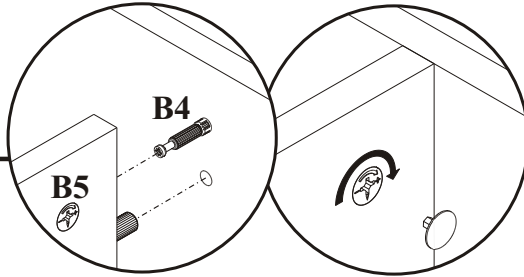
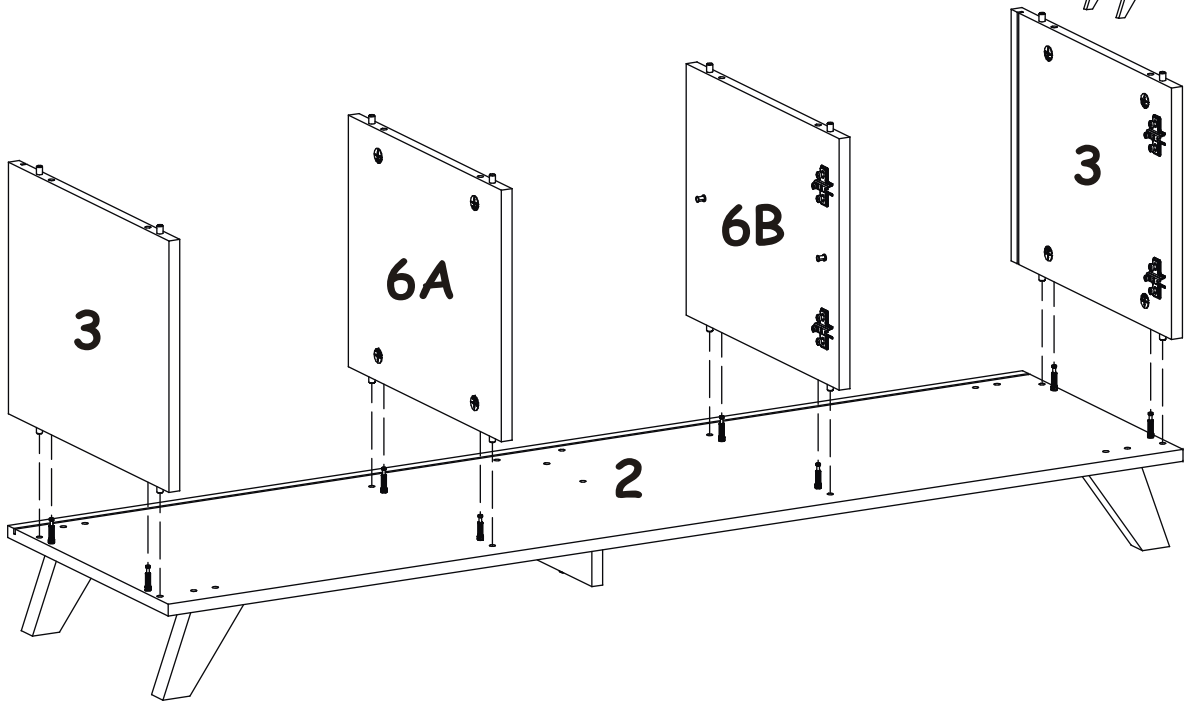
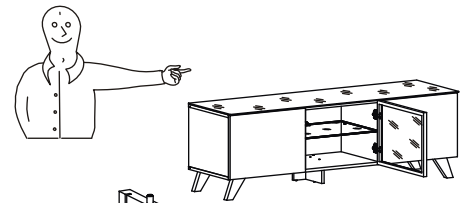

6

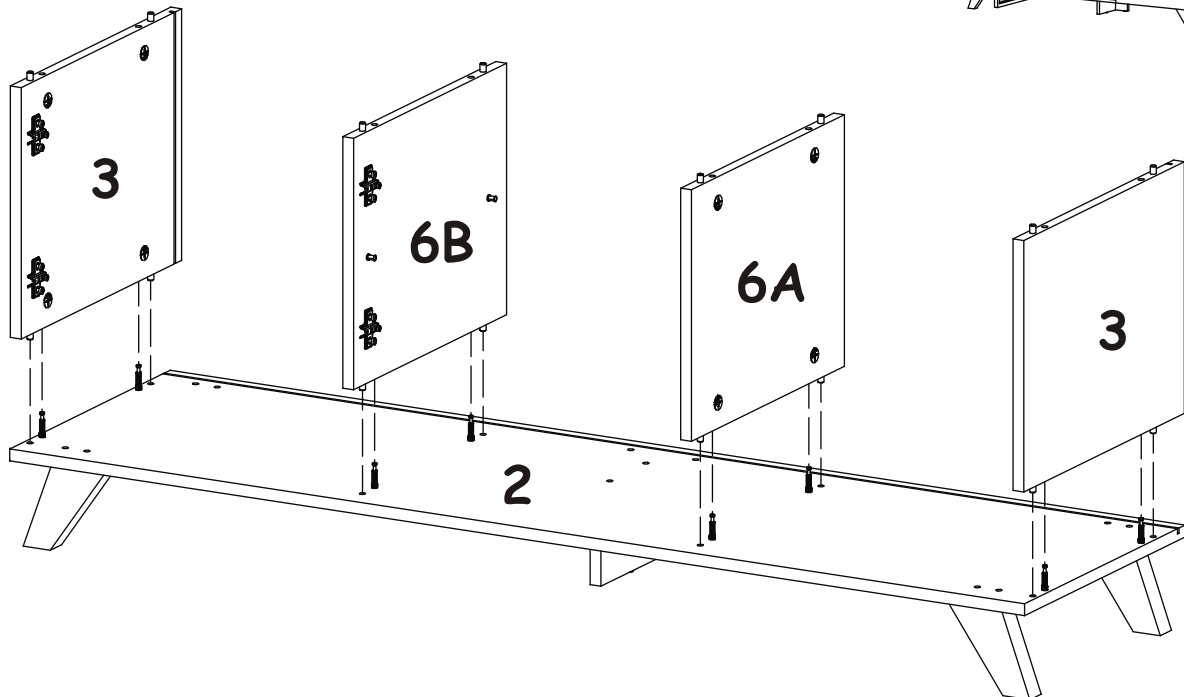
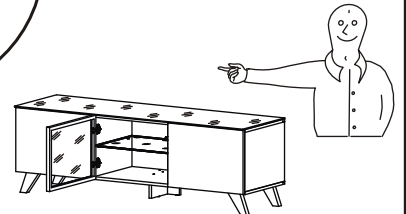

7

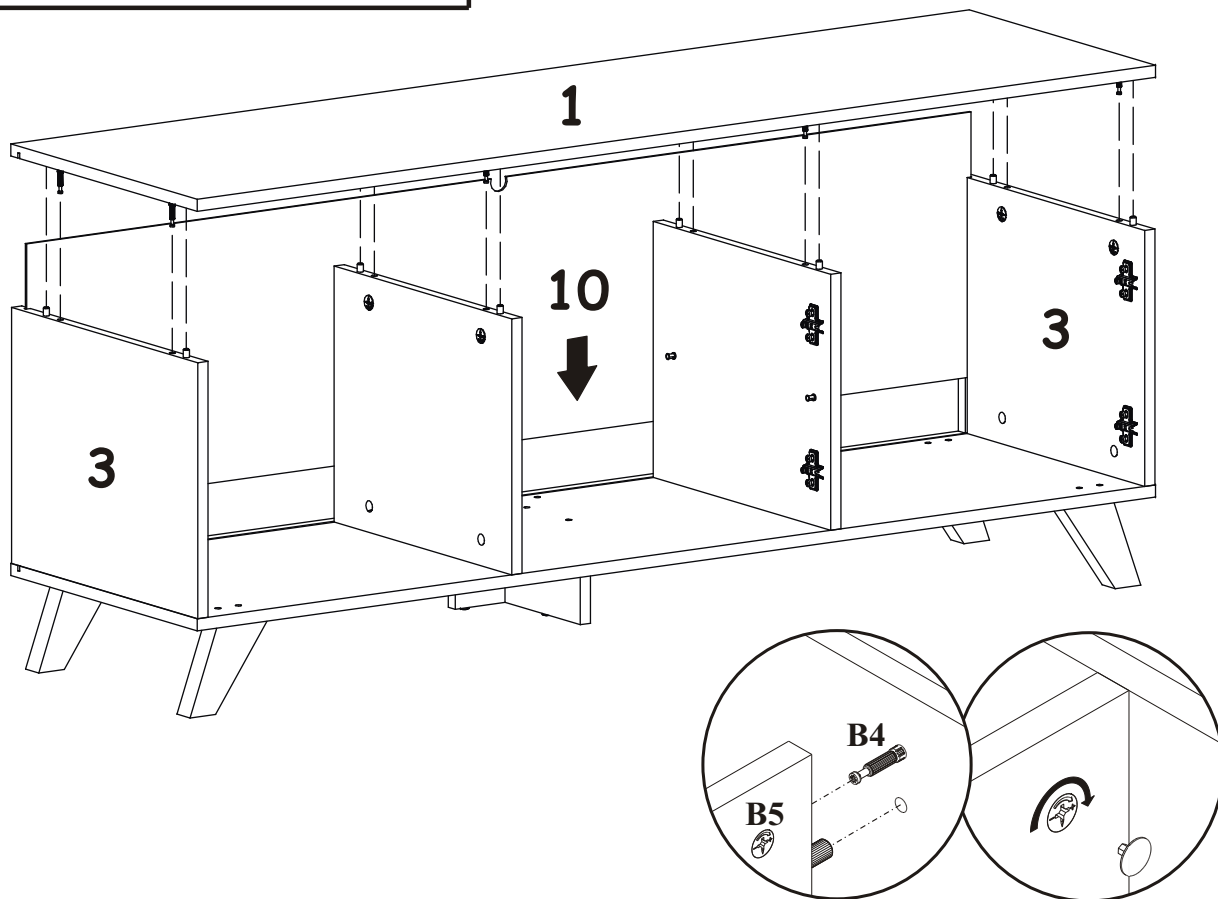

8

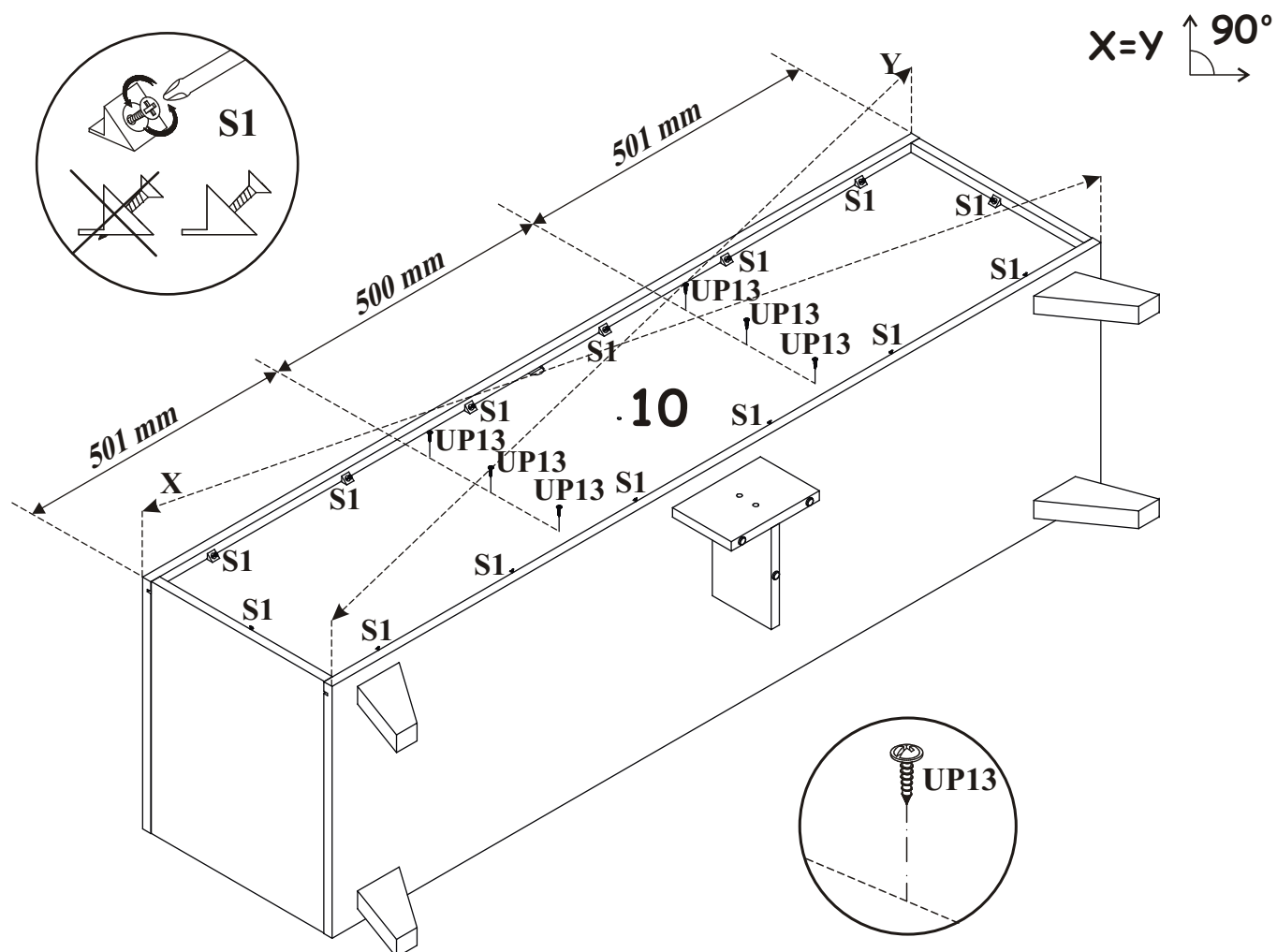

THIN 27_THTHR

9

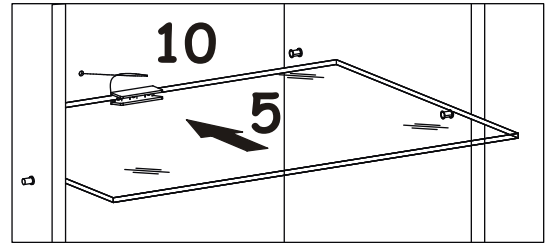
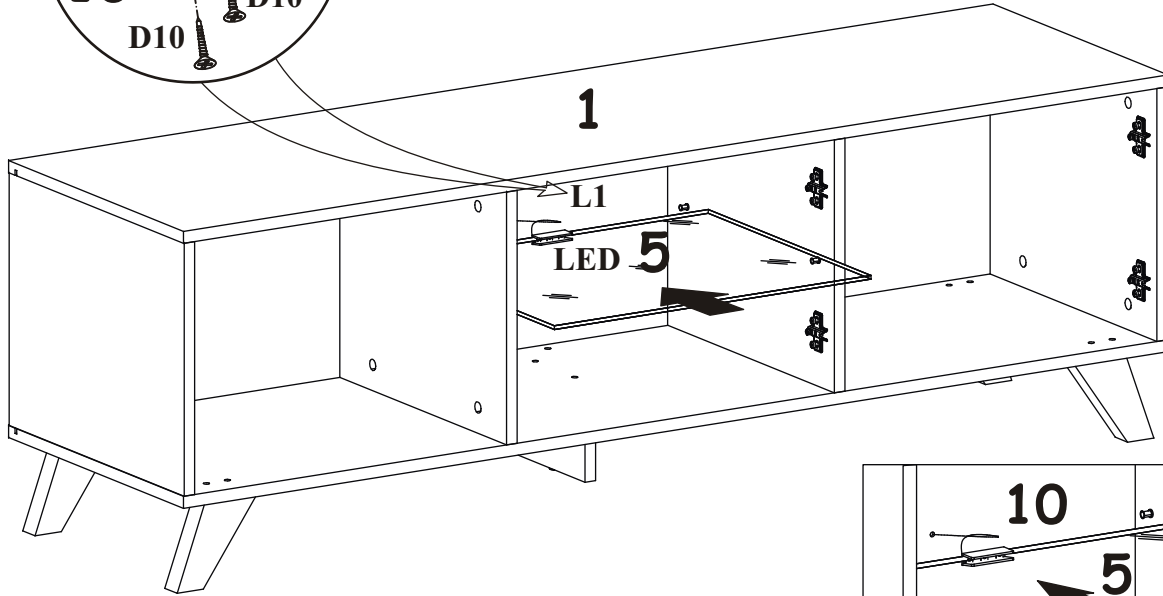
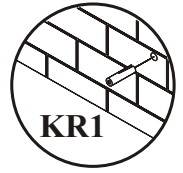
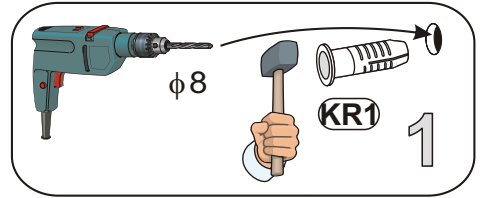
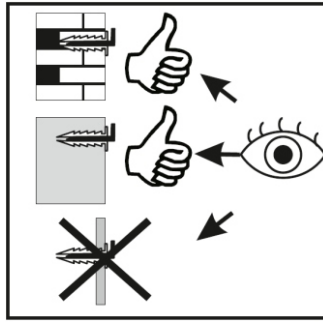
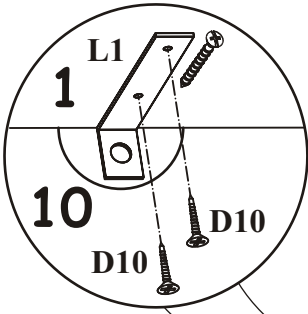

10

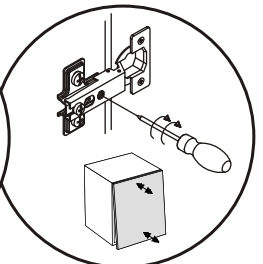
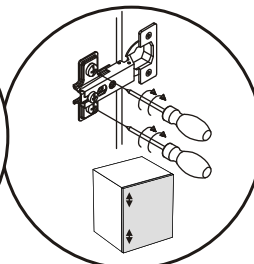
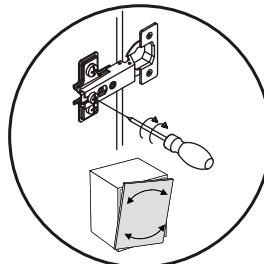
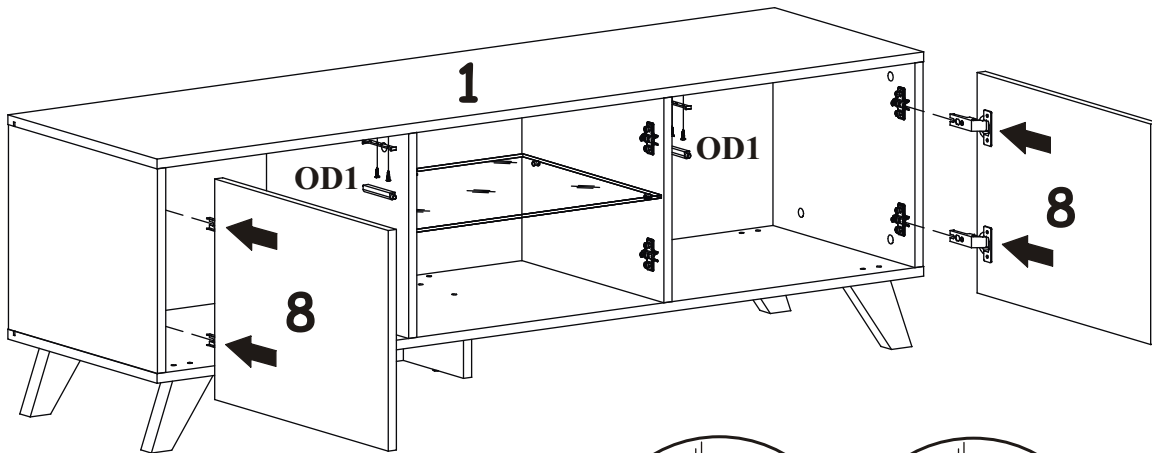
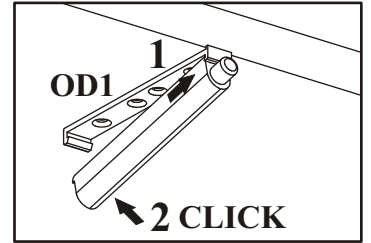
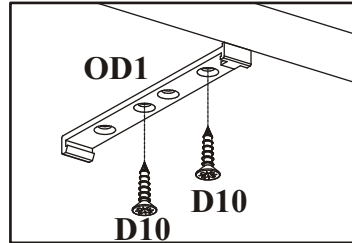

11

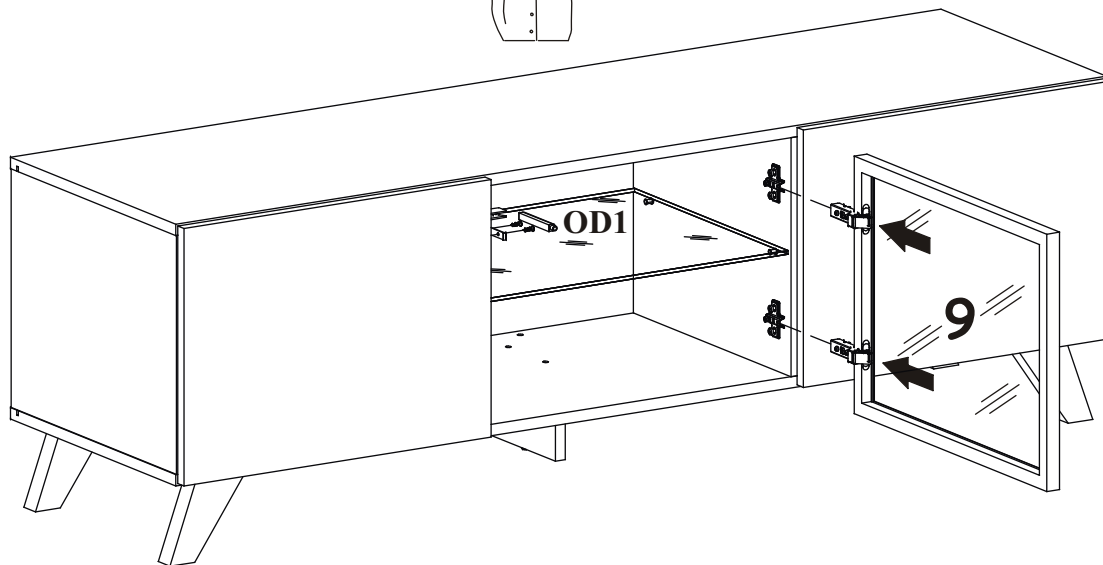
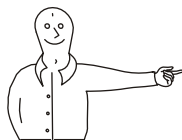

11

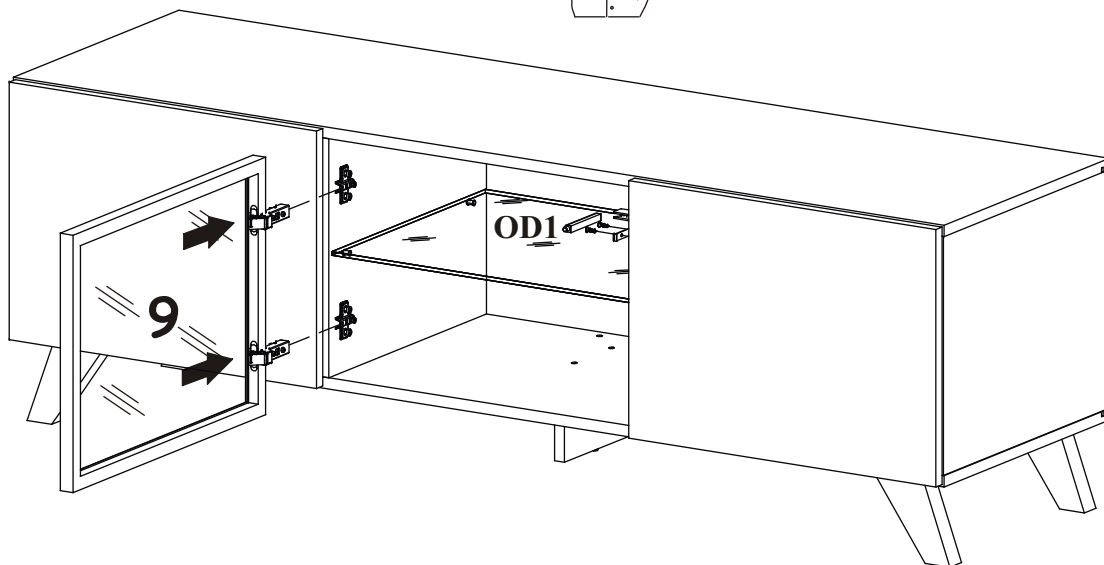
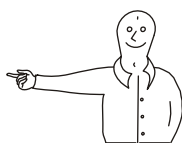
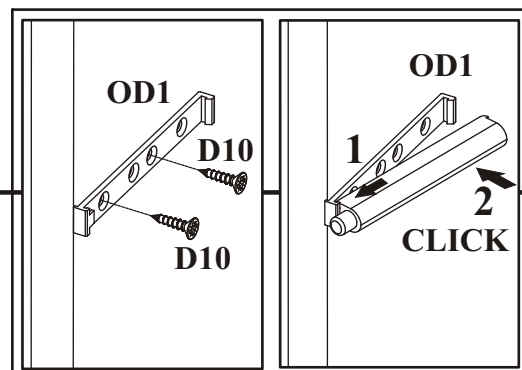
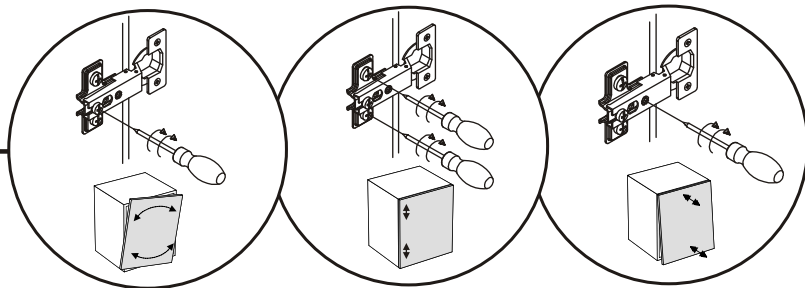

12

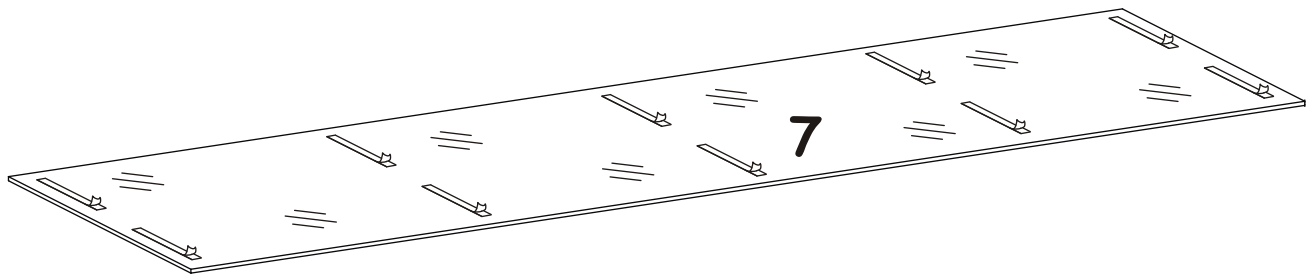
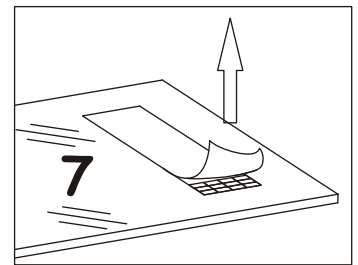

13

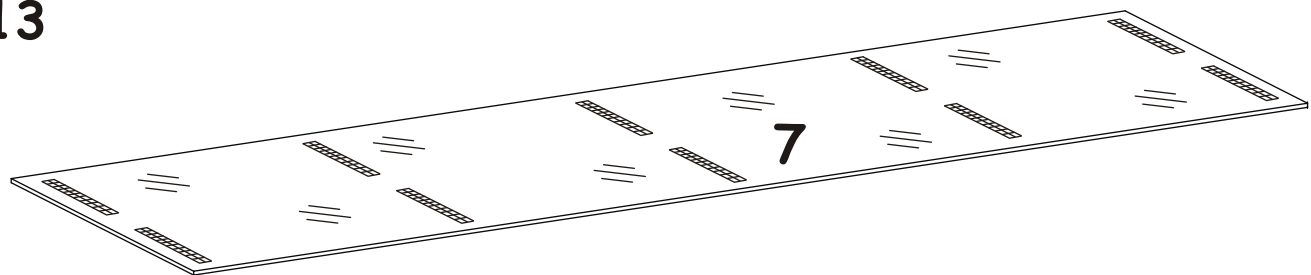

180°

