

# CREMONA

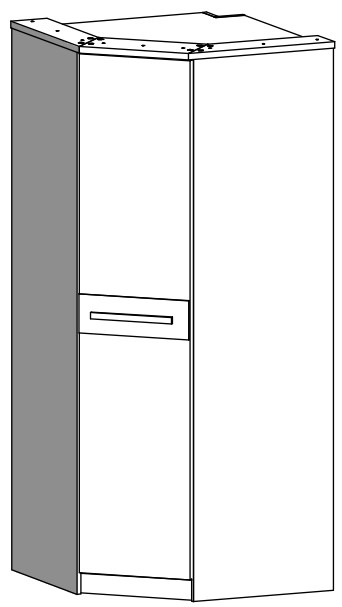

<i>e - 003 (x23)</i> 	<i>e - 221 (x18)</i> 	<i>e - 001 (x18)</i> 	<i>e - 312 (x4)</i> 	<i>e - 300 (x4)</i> 	<i>e - 017 (x24)</i> 	<i>e - 113 (x2)</i> 
<i>e - 280 (x1)</i> 	<i>e - 050 (x4)</i> 	<i>e - 016 (x8)</i>  4 x 16	<i>e - 009 (x6)</i> 	<i>e - 120 (x9)</i>  4 x 45	<i>e - 055 (x6)</i>  5 x 70	<i>e - 011 (x90)</i>  3 x 25
						<i>e - 124</i> 

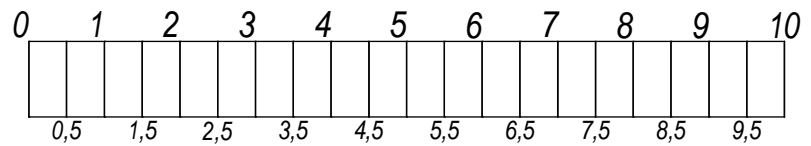

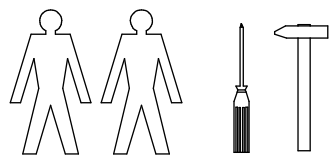
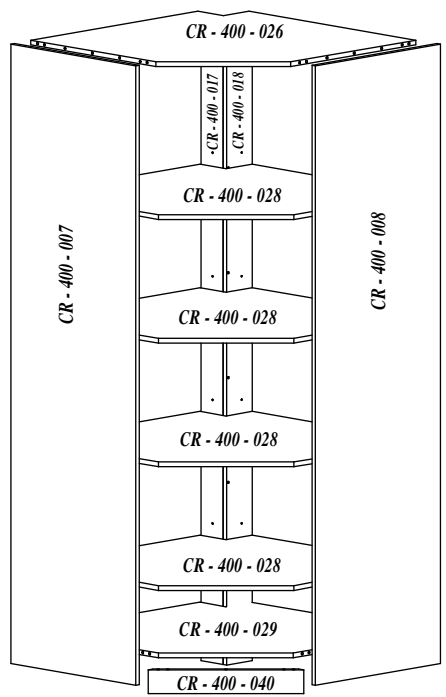
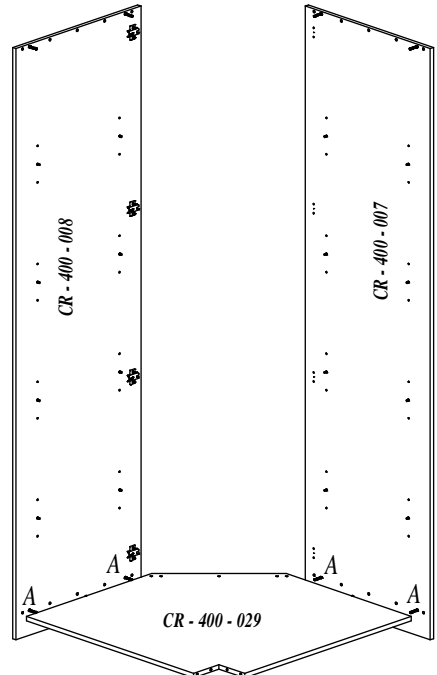
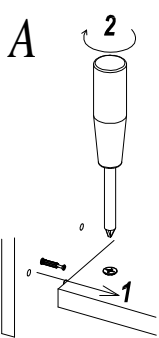
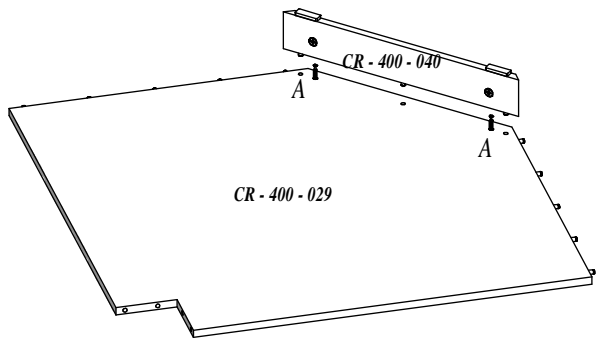
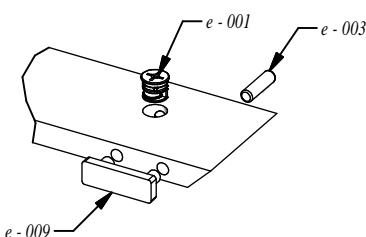
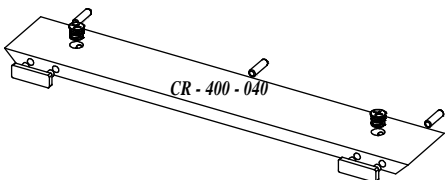
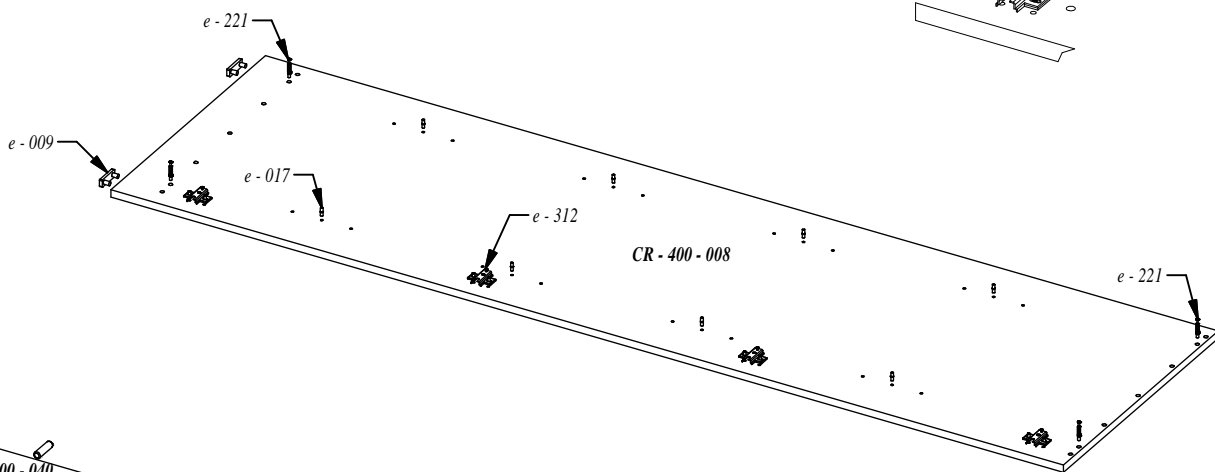
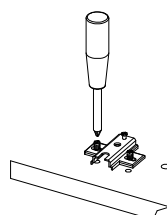
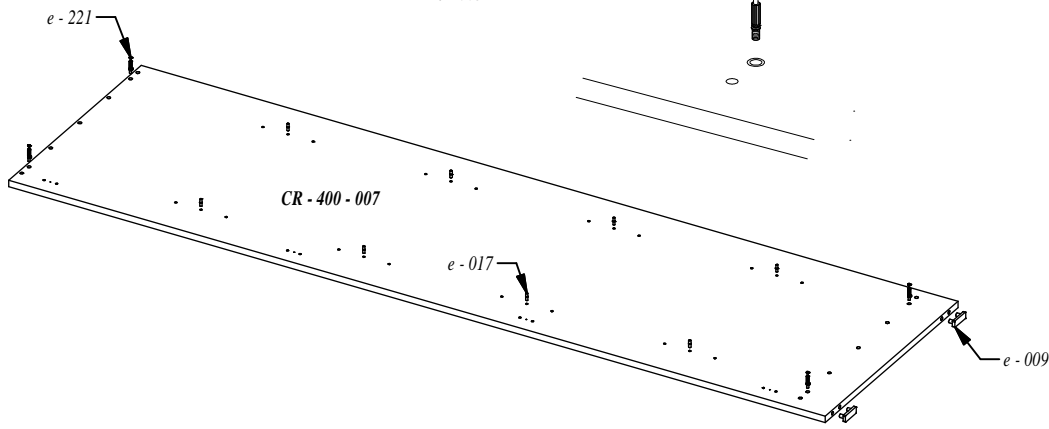
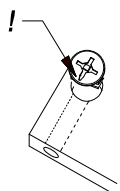
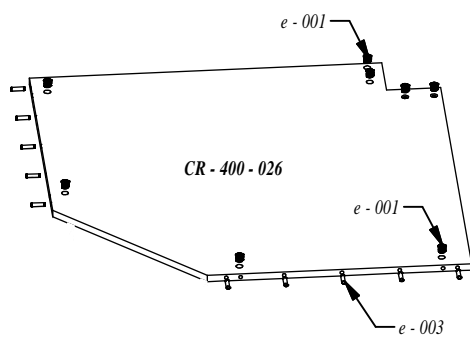
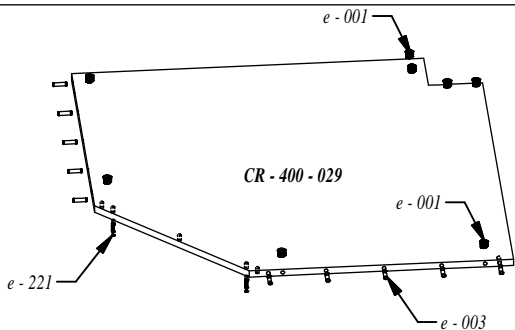

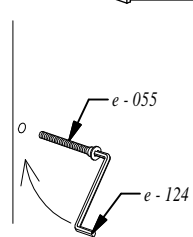
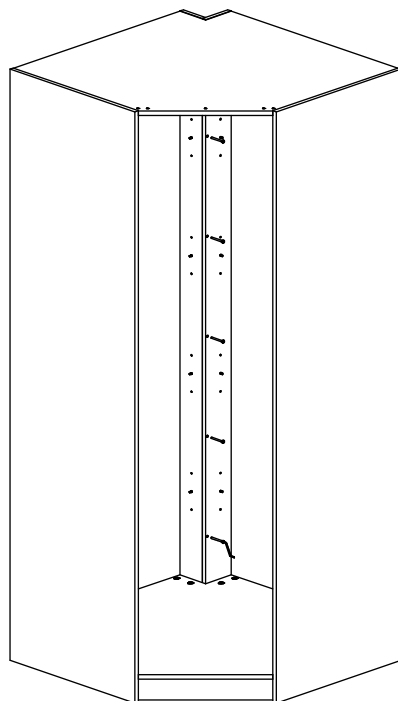
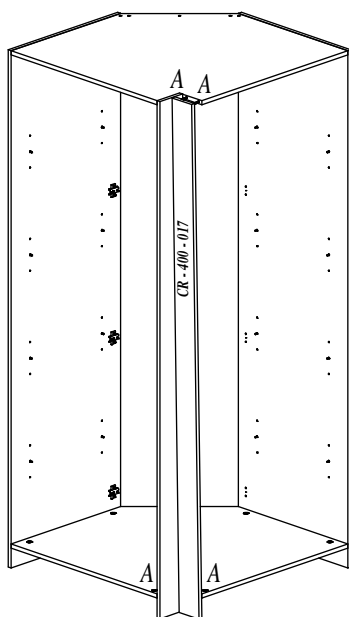
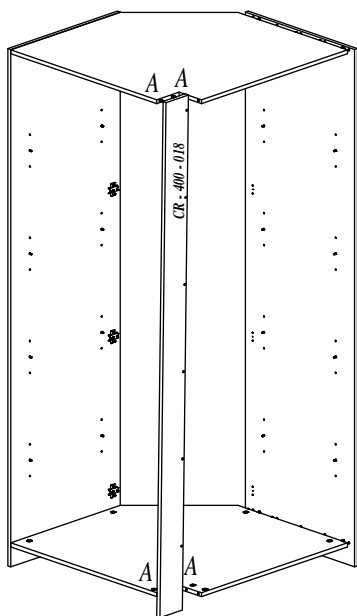
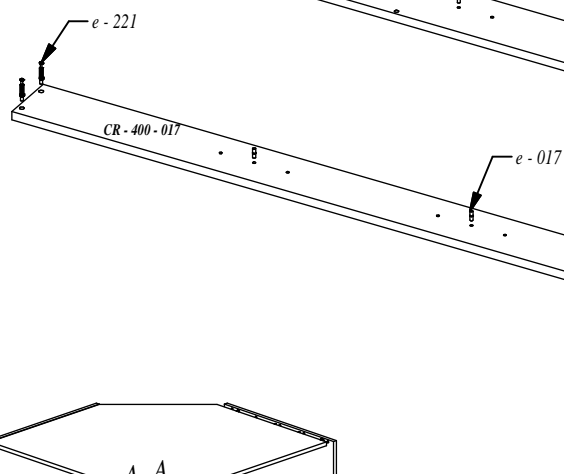
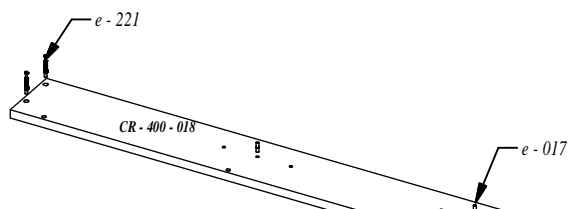
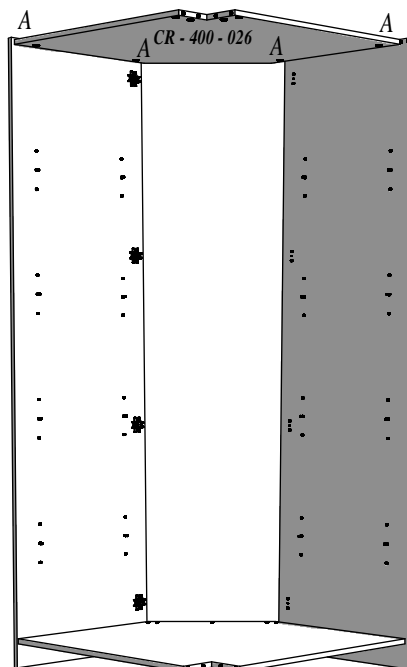
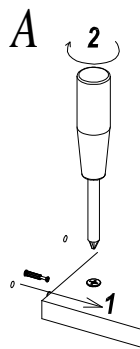

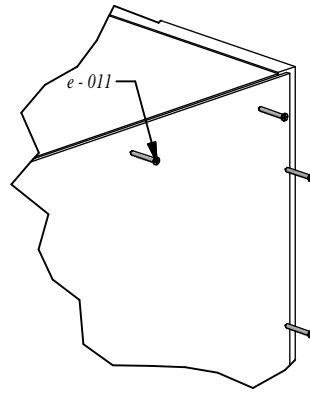
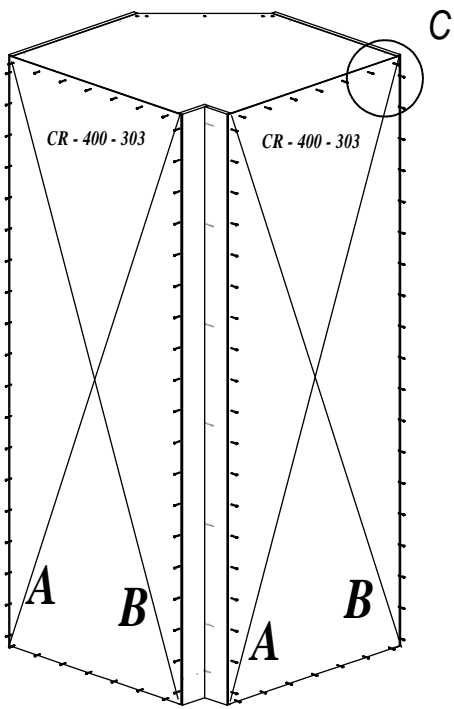

**A = B !!!**

