

# RISE - 70

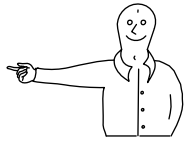

5-6/8

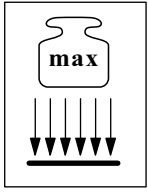
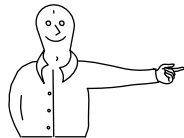
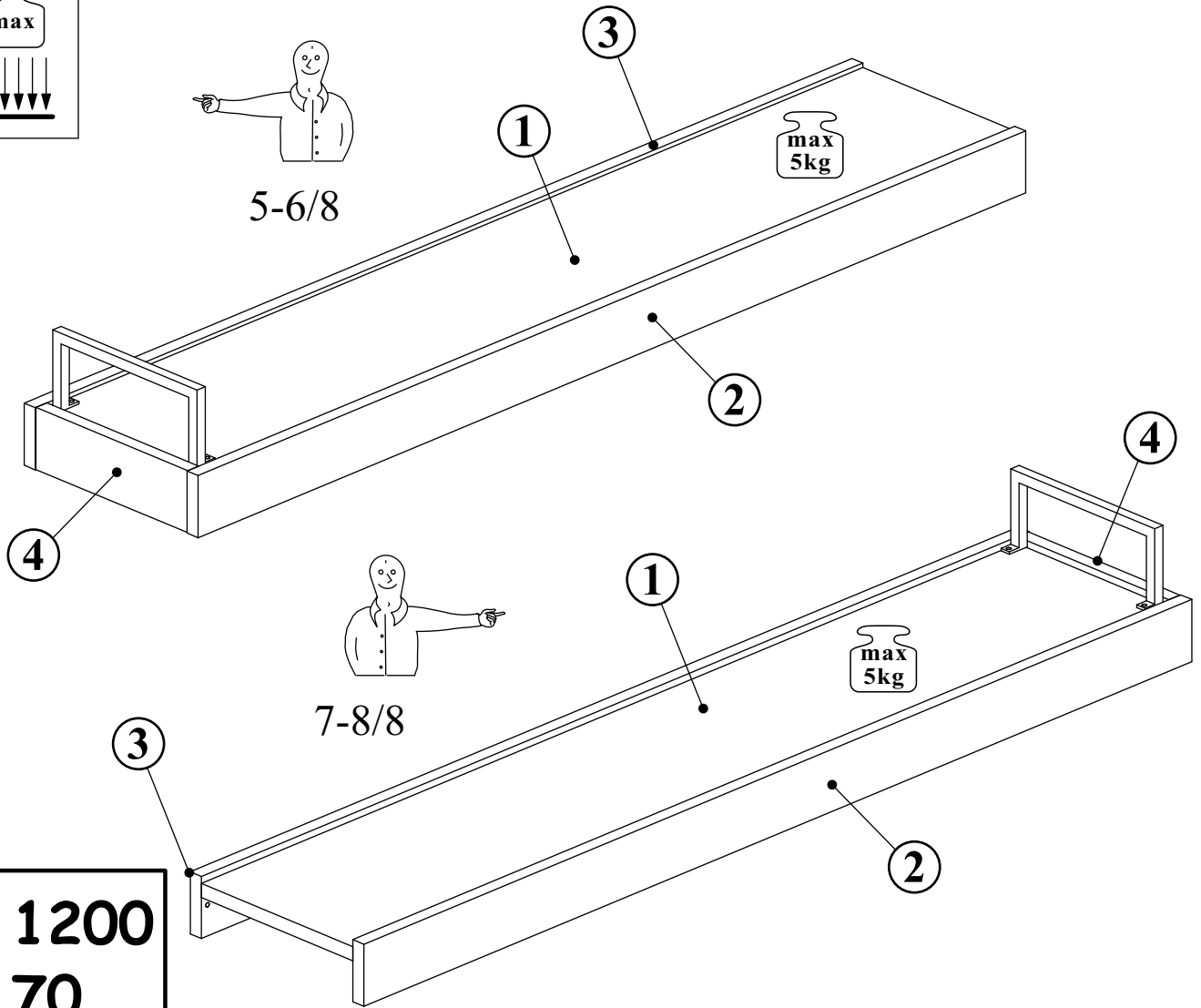

7-8/8

→ 1200  
 ↑ 70  
 ↗ 252



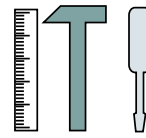
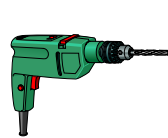



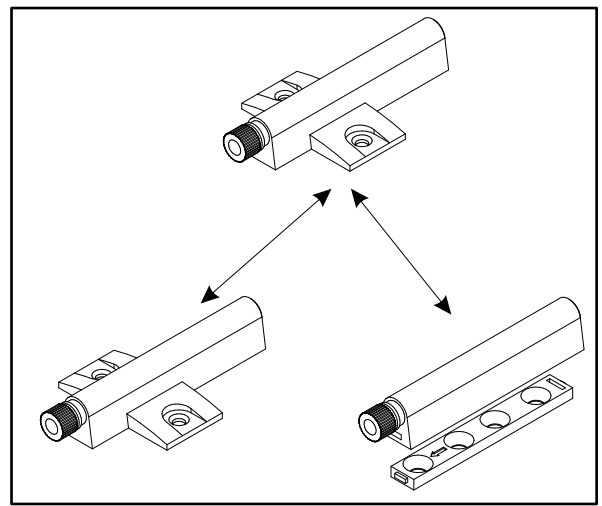
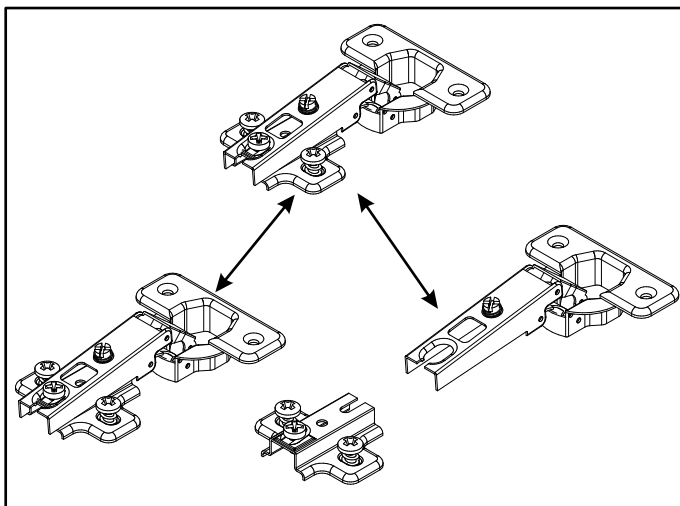
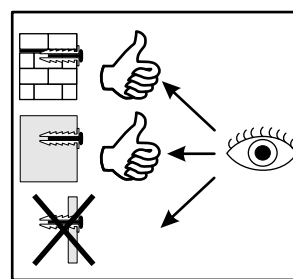
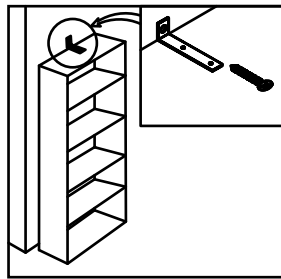
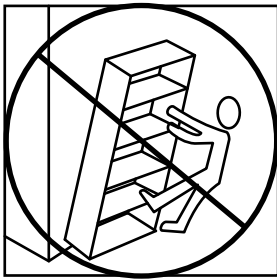
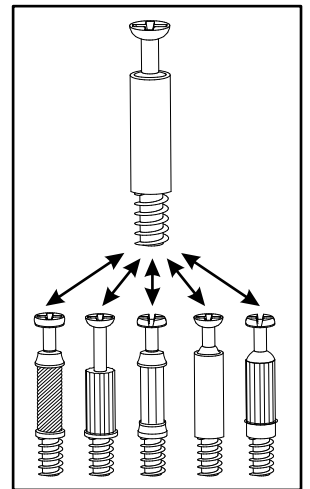
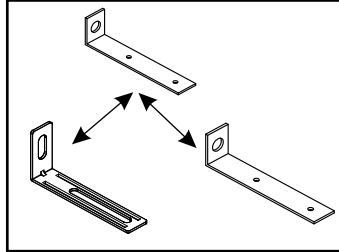
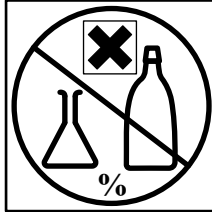
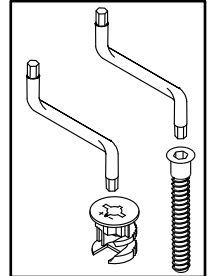
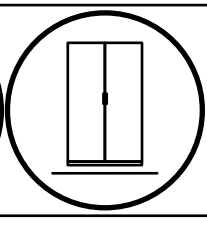
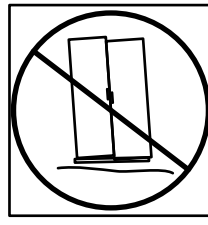
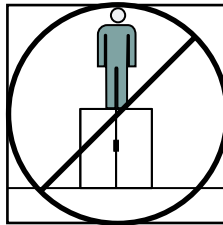
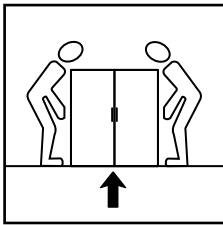
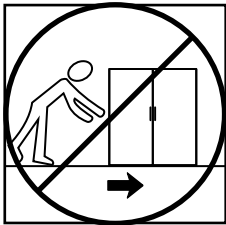
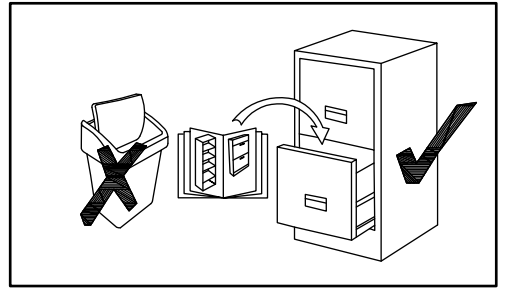
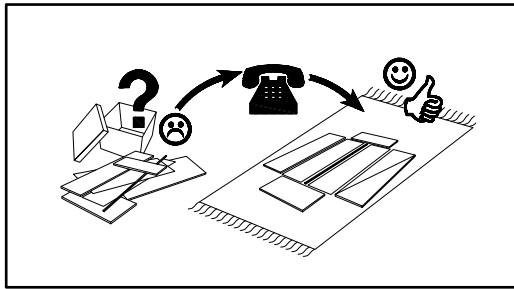
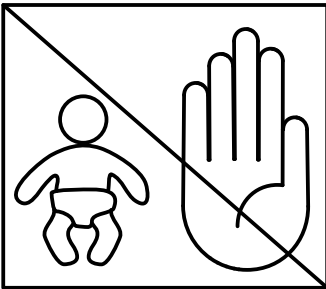
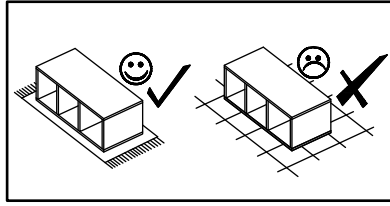
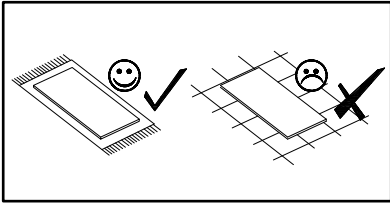

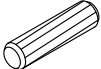
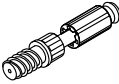

NO	Dim.			Col.-No	Qty
1	1183	220	16	1/3	1
2	1200	70	16	1/3	1
3	1200	70	16	1/3	1
4	220	70	16	1/3	1

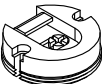

45 min

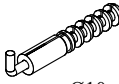

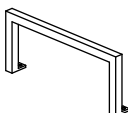
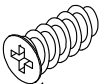

# RISE - 70

A1 x8 ø8x36		B4 x12		B5 x12 ø15x12		G5 x12		Z2 x2 ø5		ZM1 x2	
G2 x1		KR3 x2 ø10		UP13 x2 UPø3x16		PA1 x1		D20 x4 ESø6x9,5		D10 x2 USø3,5x13	
P3 x2											

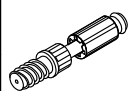

# RISE - 70

## 1

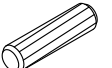
B4		B5		A1	
x2		x12	ø15x12	x8	ø8x36

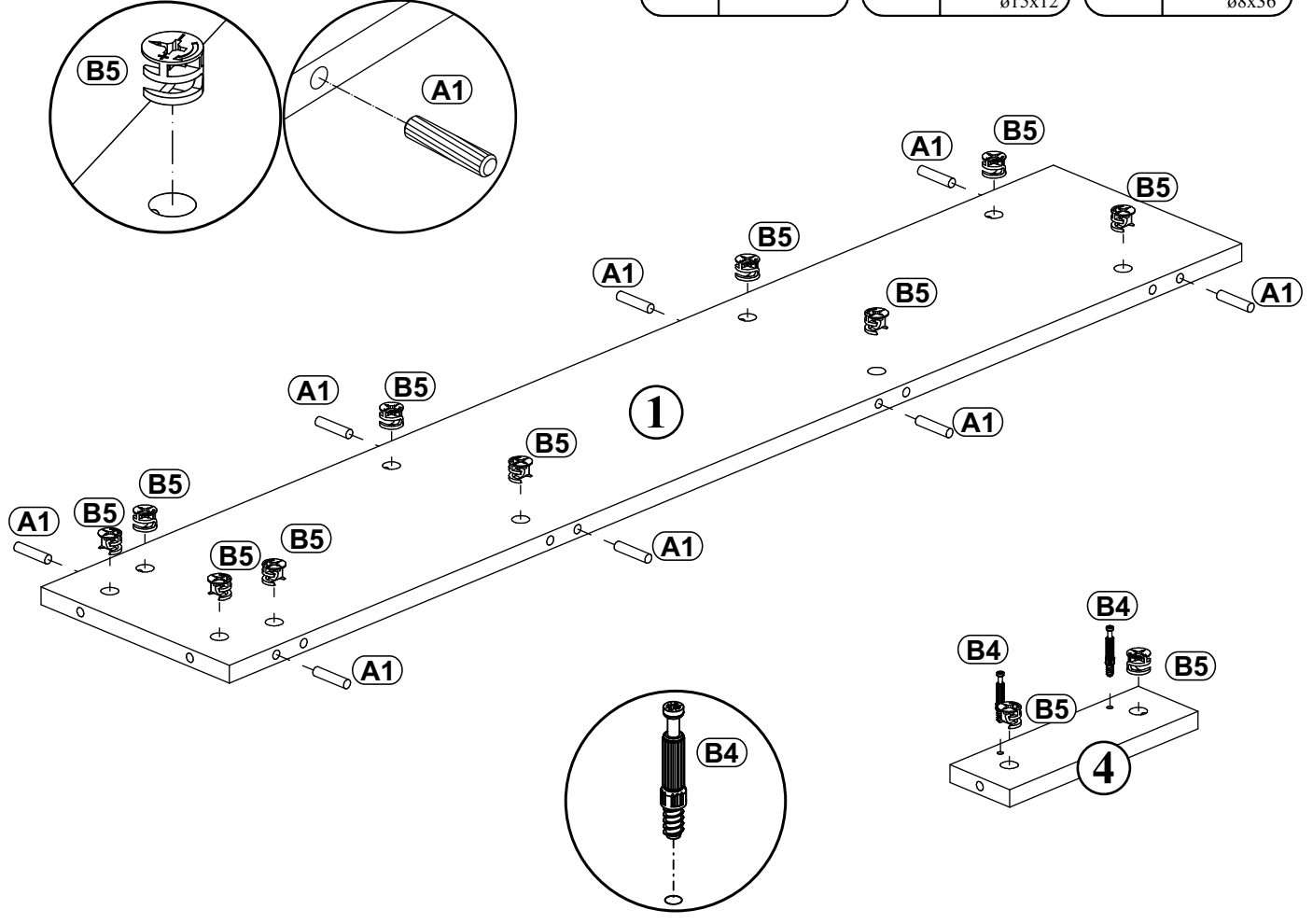

## 2

G5	
x2	

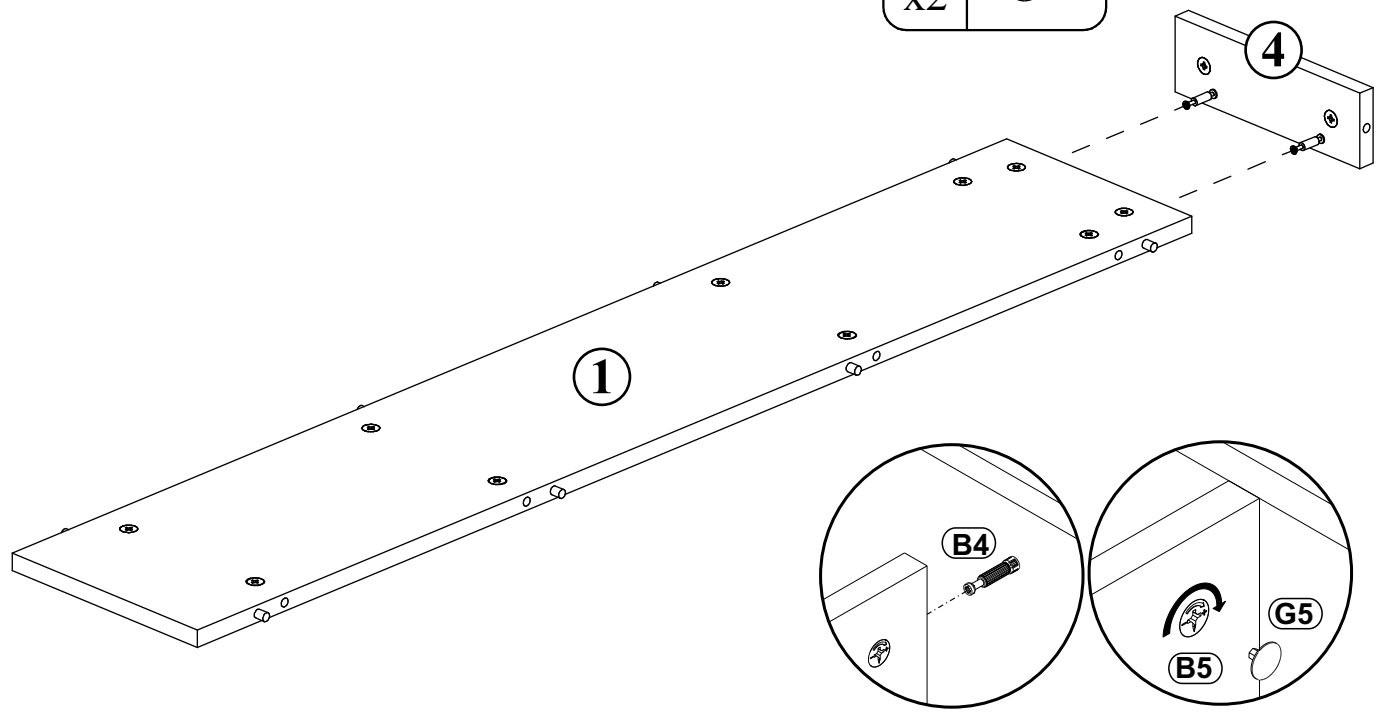

RISE - 70



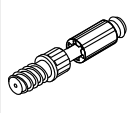

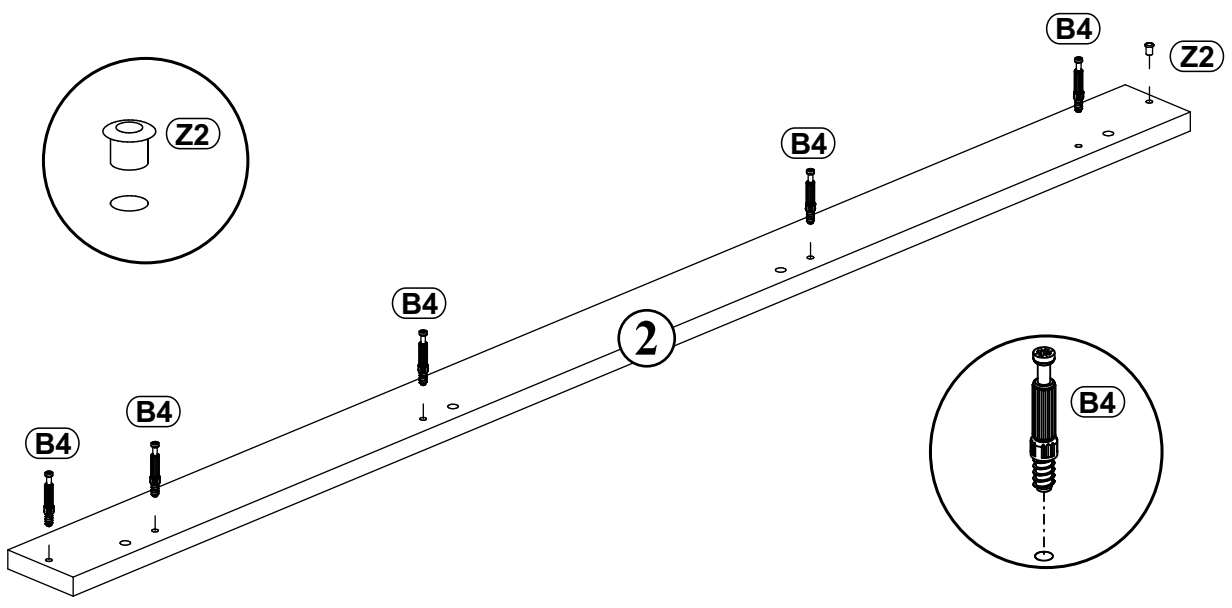
3

Z2		B4	
x1	Ø5	x5	

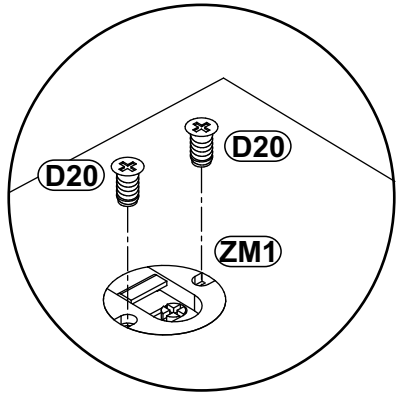
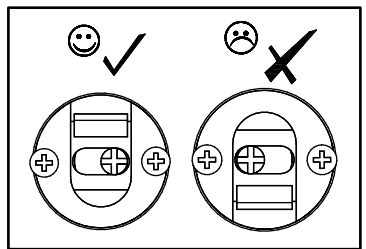

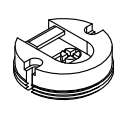
4



ZM1		D20	
x2		x4	ESØ6x9,5
D10		P3	
x2	USØ3,5x13	x2	

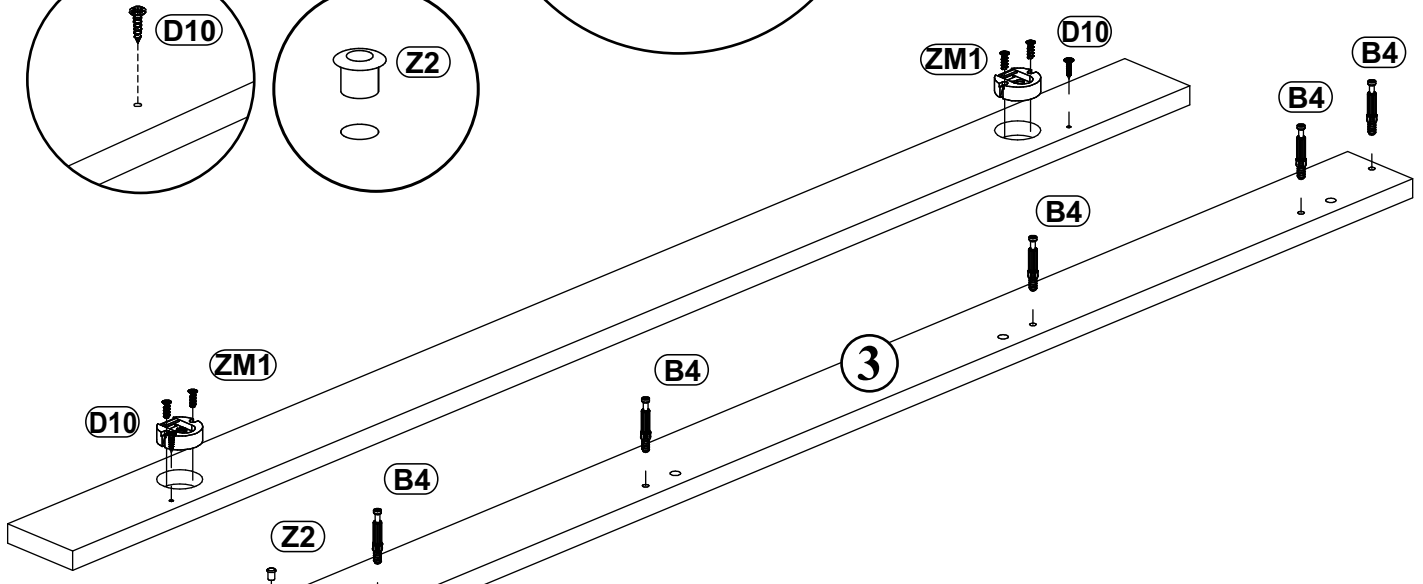
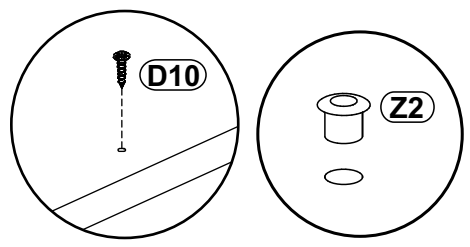

180°

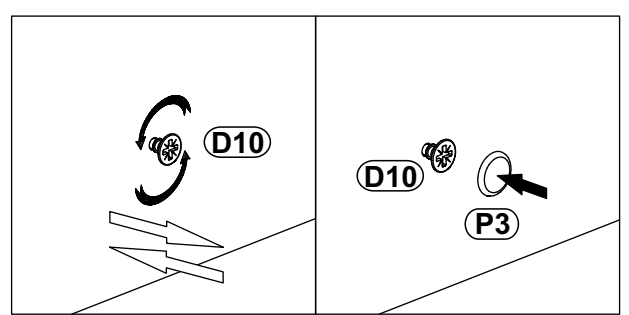
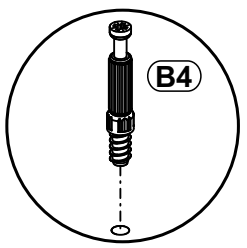

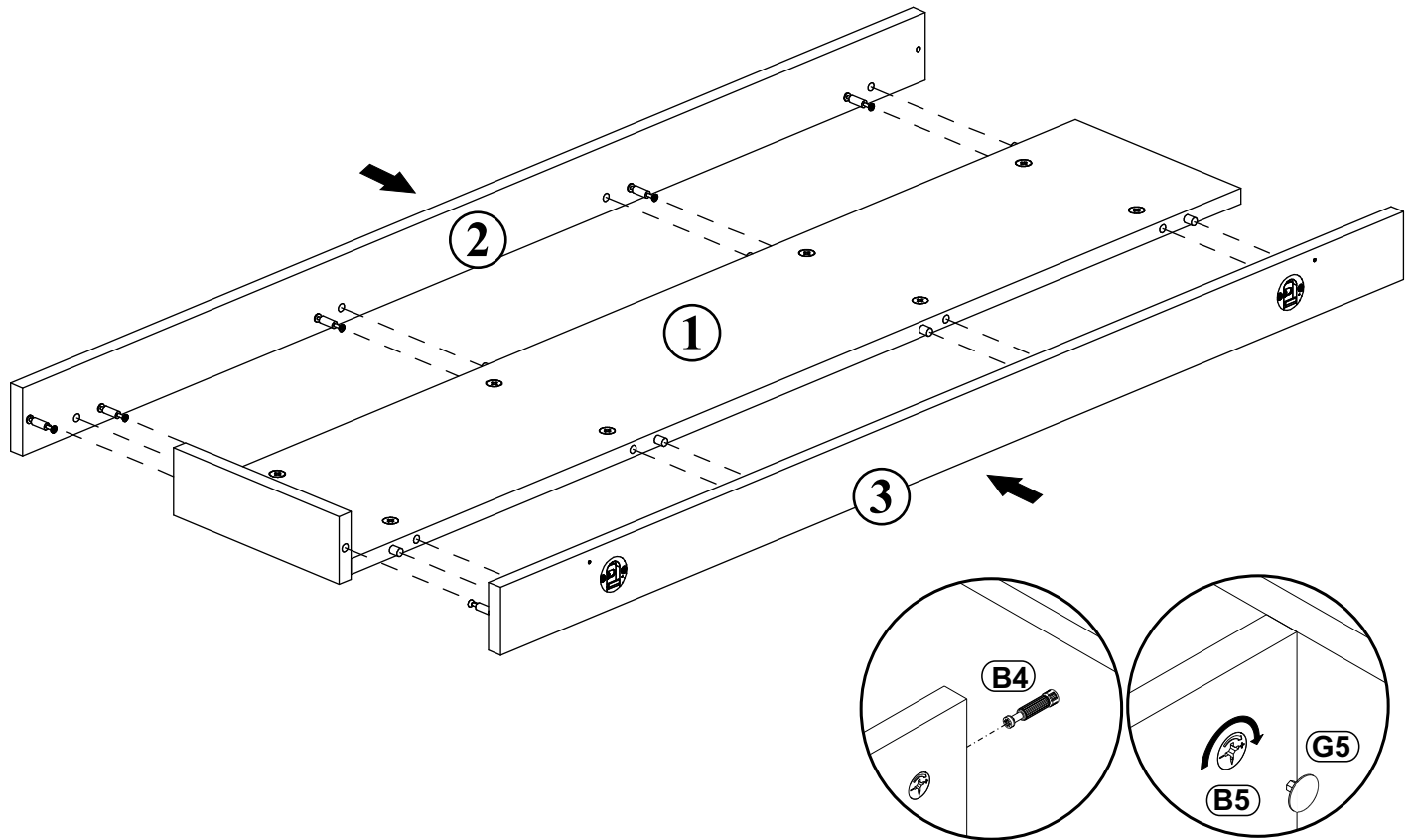

5

G5	
x10	

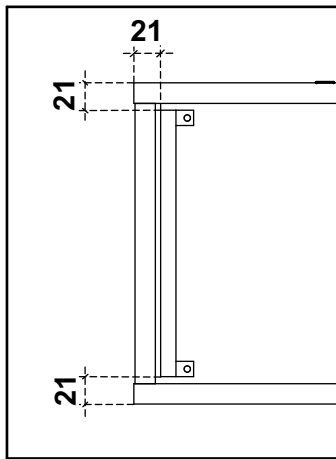

6

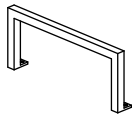

PA1		UP13	
x1		x2	UPØ3x16

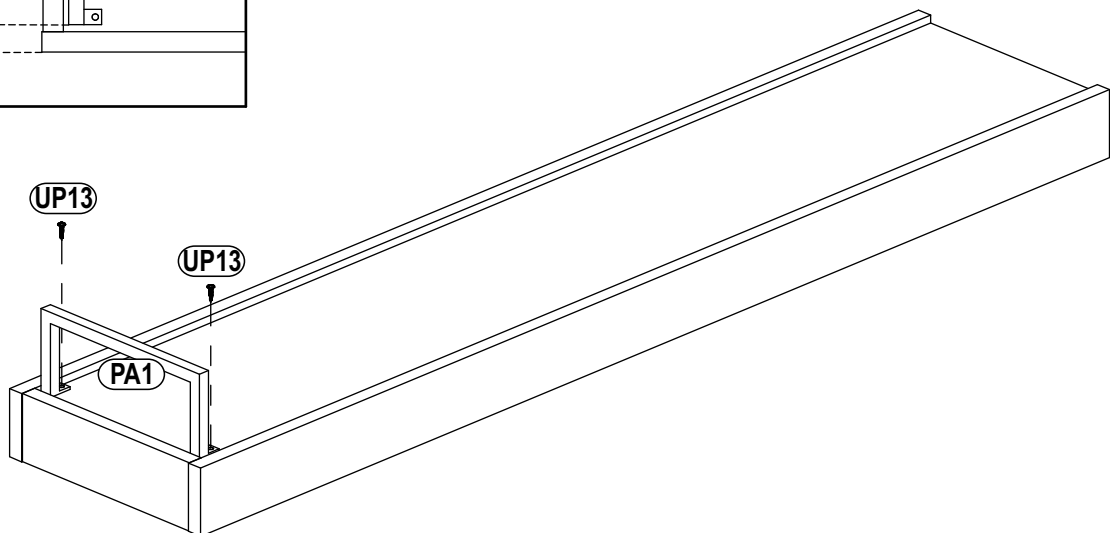



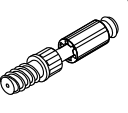

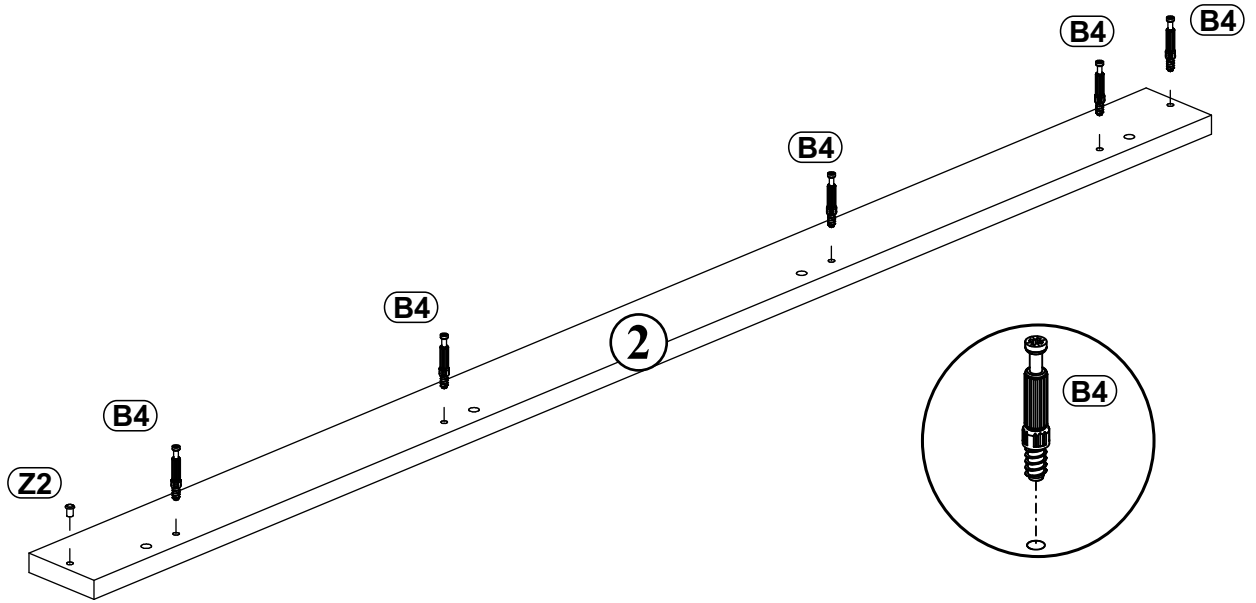
7

Z2		B4	
x1	Ø5	x5	

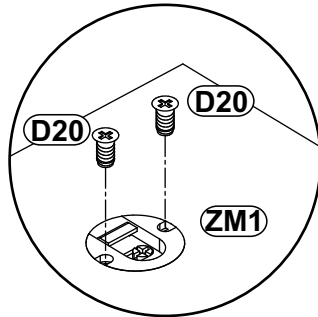
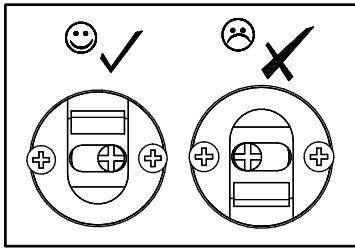

8



ZM1		D20	
x2		x4	ESØ6x9,5
D10		P3	
x2	USØ3,5x13	x2	

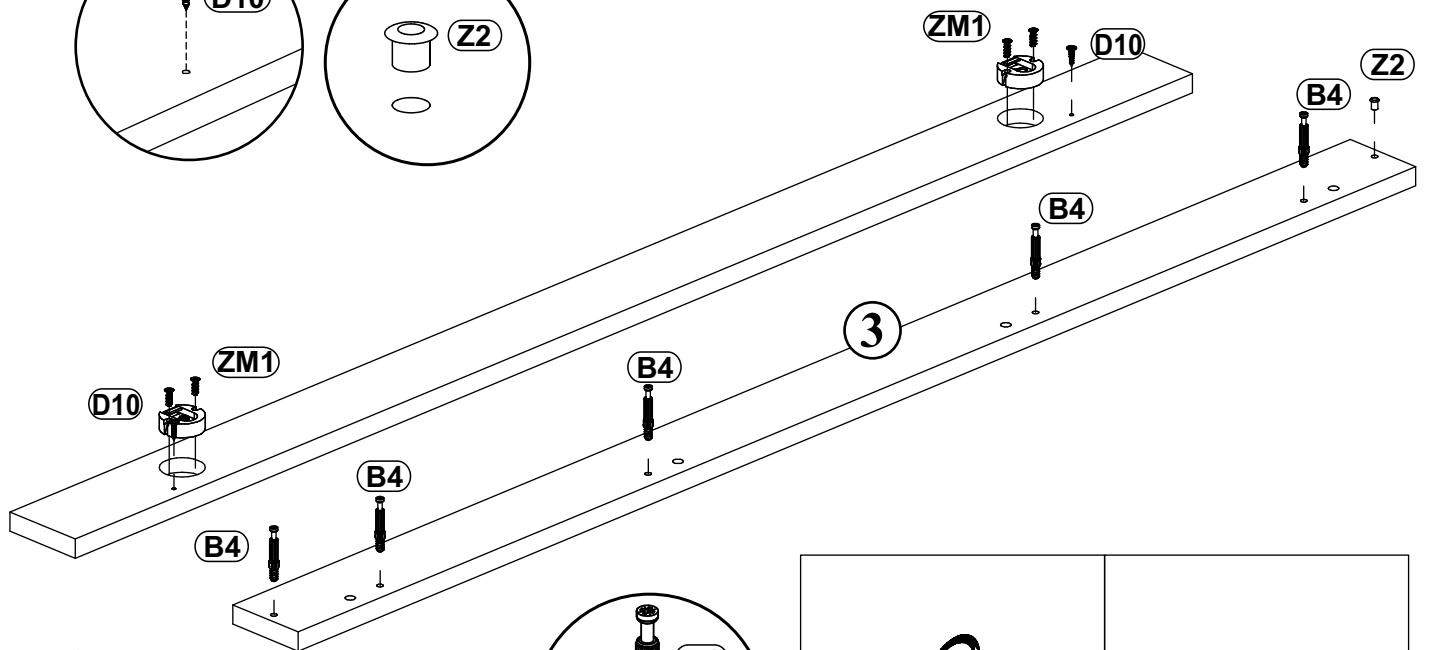
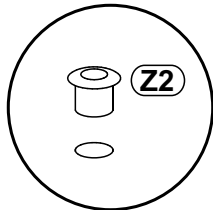
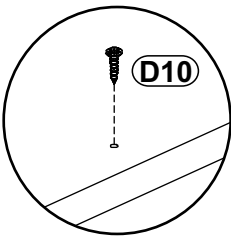

180°

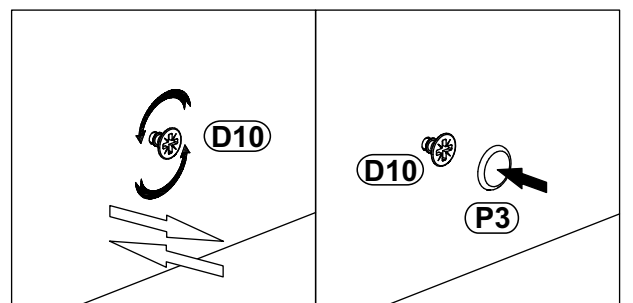

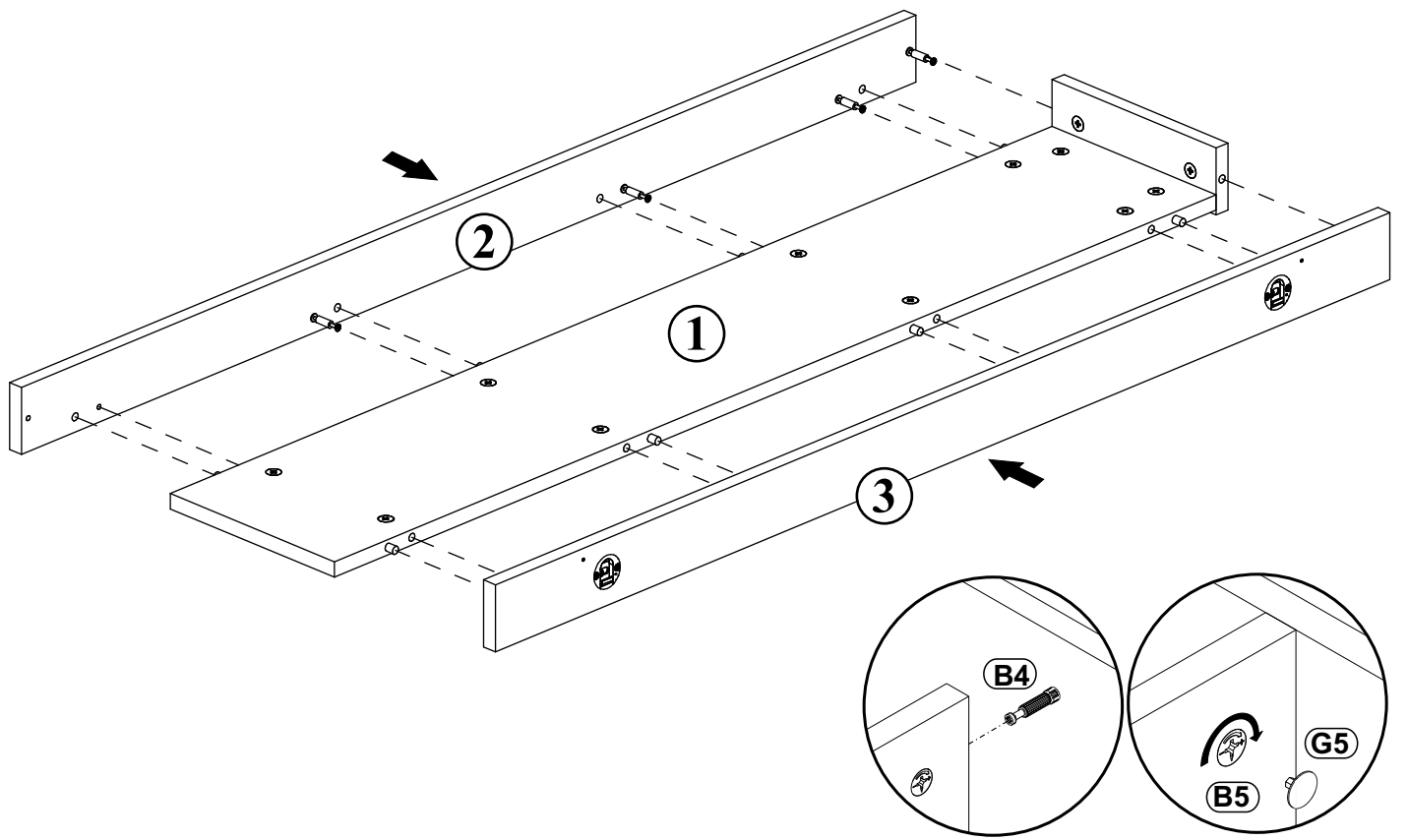

9

G5	
x10	

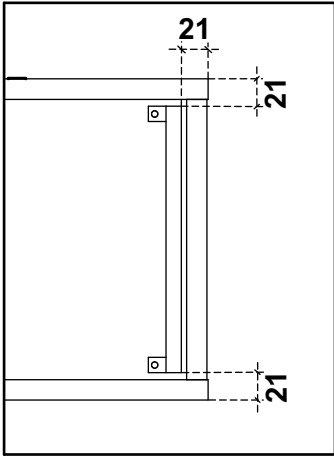

10

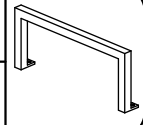

PA1		UP13	
x1		x2	UPØ3x16

