

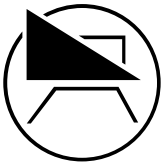

PREGGIO WIT90

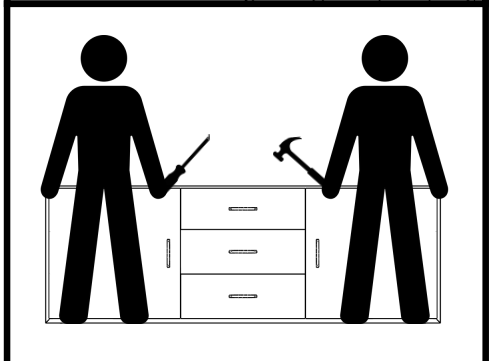

INSTRUKCJA MONTAŻU • ASSEMBLY INSTRUCTION • MONTAGEANLEITUNG

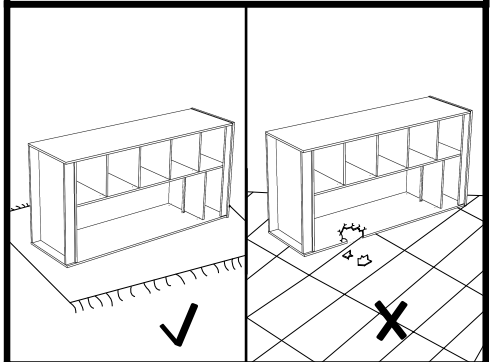
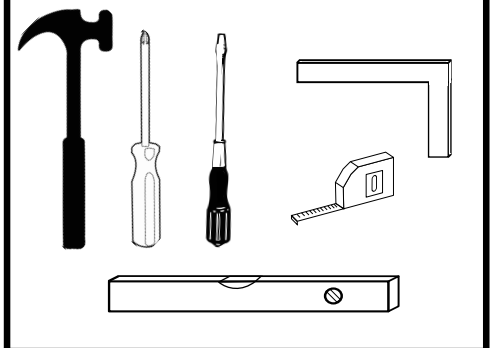
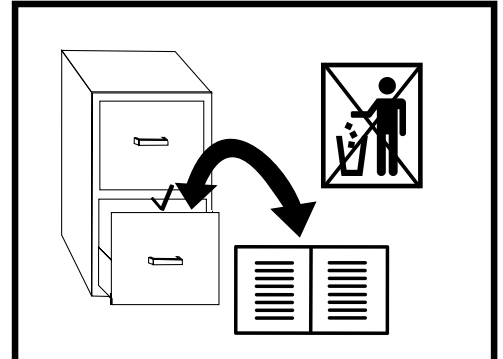
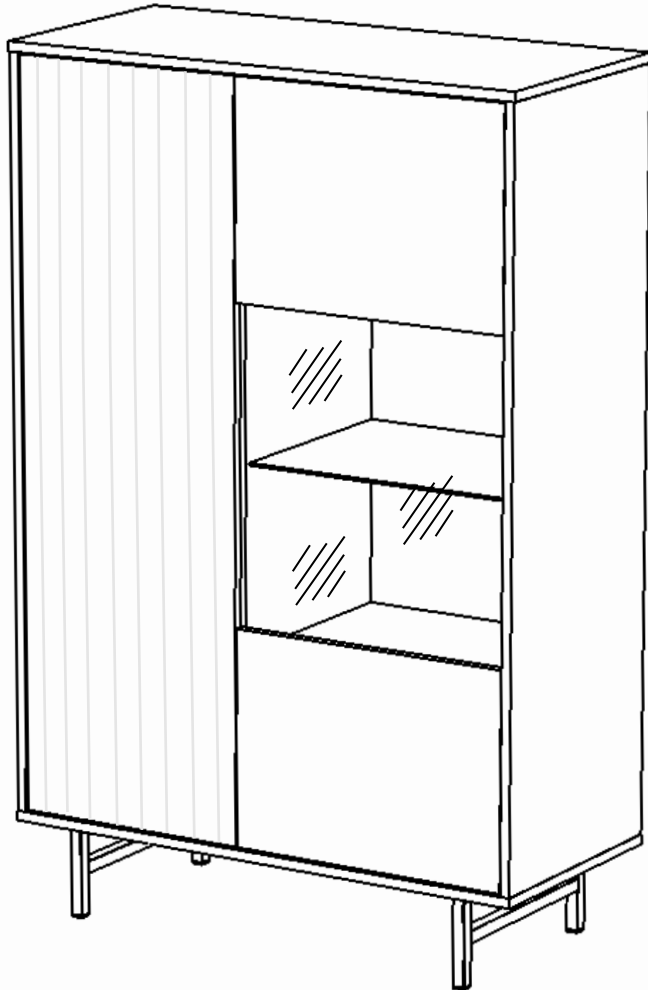

PG-07-CCD

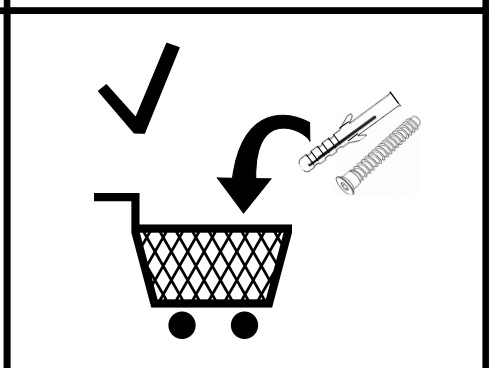
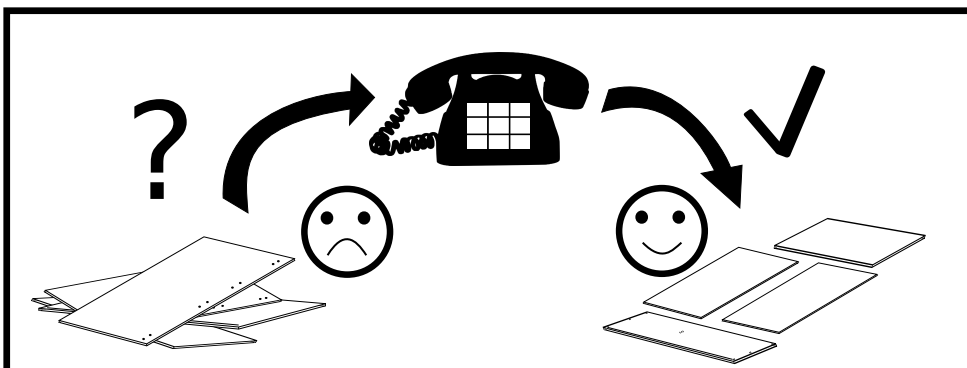



PL Przed montażem należy dokładnie zapoznać się z instrukcją montażu. Należy zamontować wszystkie akcesoria zabezpieczające oraz stosować się do wskazówek zawartych w instrukcji podczas montażu i użytkowania. Nie wolno stawiać na meblu ciężkich przedmiotów oraz używać go w innym celu niż jego przeznaczenie.

Po zmontowaniu należy wyrównać poziom i pion mebla oraz wyregulować drzwi na zawiasach.

Czyszczenie należy wykonywać wyłącznie za pomocą ściereczki lub lekko nawilżonego ręcznika. Nie stosować środków czyszczących do szorowania.

DE Lesen Sie vor der Installation die Montageanleitung sorgfältig durch. Installieren Sie alle Sicherheitszubehörteile und befolgen Sie während der Montage und Verwendung die Anweisungen im Handbuch. Stellen Sie keine schweren Gegenstände auf die Möbel und verwenden Sie sie nicht zweckentfremdet.

Richten Sie nach der Montage die Ebene und Vertikale des Möbels aus und justieren Sie die Flügeltür.

Die Reinigung sollte nur mit einem Lappen oder einem leicht angefeuchteten Tuch erfolgen. Verwenden Sie keine Scheuermittel.

SK Pred inštaláciou si pozorne prečítajte montážny návod. Nainštalujte všetko bezpečnostné príslušenstvo a počas montáže a používania dodržiavajte pokyny v návode. Na nábytok nekladte ťažké predmety a nepoužívajte ho na iný účel, než na ktorý je určený.

Po montáži zarovnajete úroveň a vertikálu nábytku a nastavte krídlové dvere.

Čistenie by sa malo vykonávať iba handričkou alebo mierne navlhčenou utierkou. Nepoužívajte abrazívne čistiace prostriedky.

RO Vă rugăm să citiți cu atenție instrucțiunile de asamblare înainte de instalare. Instalați toate accesoriile de siguranță și urmați instrucțiunile din manual în timpul instalării și utilizării. Nu puneți obiecte grele pe mobilier și nu o utilizați contrar utilizării pentru care a fost prevăzut.

După asamblare, nivelați poziția mobilierului și reglați ușa cu balamale.

Curățarea trebuie făcută numai cu o cârpă sau un prosop ușor umez. Nu utilizați produse de curățare abrazive.

FR Avant l'installation, lisez attentivement les instructions de montage. Installez tous les accessoires de sécurité et suivez les instructions du manuel lors du montage et de l'utilisation. Ne placez pas d'objets lourds sur le meuble et ne l'utilisez pas à d'autres fins que celles pour lesquelles il a été conçu.

Après le montage, alignez le niveau et la verticale du meuble et ajustez la porte battante.

Le nettoyage doit être effectué uniquement avec un chiffon ou une serviette légèrement humide. N'utilisez pas de nettoyeurs à récurer.

EN Before installing, read the assembly instructions carefully. Install all safety accessories and follow the instructions during installation and use. Do not put heavy objects on the furniture and do not use it for any purpose other than its intended use.

After assembly, align the level and vertical of the furniture and adjust the hinged door.

Cleaning should only be done with a cloth or a slightly moistened towel. Do not use scouring cleansers.

NL Lees voor de montage de montagehandleiding aandachtig door. Installeer alle veiligheidsaccessoires en volg de instructies in de handleiding tijdens montage en gebruik. Plaats geen zware voorwerpen op het meubel en gebruik het niet voor een ander doel dan waarvoor het bedoeld is.

Lijn na montage het niveau en de verticaal van het meubel uit en stel de deur af.

Reiniging mag alleen worden gedaan met een doek of een licht bevochtigde handdoek. Gebruik geen schurende reinigingsmiddelen.

CZ Před instalací si pozorně přečtete montážní návod. Nainstalujte veškeré bezpečnostní příslušenství a během montáže a používání dodržujte pokyny v návodu. Na nábytek nepokládejte těžké předměty a nepoužívejte jej k jinému účelu, než ke kterému je určen.

Po montáži vyrovnejte úroveň polohu nábytku a nastavte pantové dveře.

Čištění by mělo být prováděno pouze hadříkem nebo mírně navlhčeným ručníkem. Nepoužívejte drhnoucí čisticí prostředky.

HU Telepítés előtt figyelmesen olvassa el az összeszerelési útmutatót. Szereljen be minden biztonsági tartozékot, és kövesse a kézikönyvben található utasításokat az összeszerelés és a használat során. Ne helyezzen nehéz tárgyakat a bútorra, és ne használja a rendeltetésétől eltérő célra.

Összeszerelés után állítsa be a bútorok szintjét és függőlegesét, és állítsa be a csuklós ajtót.

A tisztítást csak ruhával vagy enyhén megnedvesített törülközővel szabad elvégezni. Ne használjon súroló tisztítószeret.

HR Prije postavljanja pažljivo pročitajte upute za montažu. Ugradite sav sigurnosni pribor i slijedite upute u priručniku tijekom sastavljanja i uporabe. Ne stavljajte teške predmete na namještaj i nemojte ga koristiti u bilo koju drugu svrhu osim za koju je namijenjen.











Nakon montaže poravnajte razinu i okomitost namještaja i namjestite vrata na šarkama.











Čišćenje treba obavljati samo krpom ili blago navlaženim ručnikom. Nemojte koristiti sredstva za čišćenje.



Prosimy sprawdzić ilość okuć • Please check the quantity of the fittings • Bitte prüfen Sie die Anzahl der Beschläge
 przed montażem. before assembly. vor der Montage.

Akcesoria • Accessories • Zubehör

24	24	28	14	7	6
 B	 A 8.0x35	 D 3.5x16 W2	 PZ	 T	
 X	 S3	 S4 3.5x16 W4	 KS	 Z	
24	4	4	7	1	7

8	2	2	4	2	8
 I	 PTS	 O	 NP2	 NP1	 WS
 F 6.3x13	 G4	 G3	 G2	 G	
16	6	16	4	12	

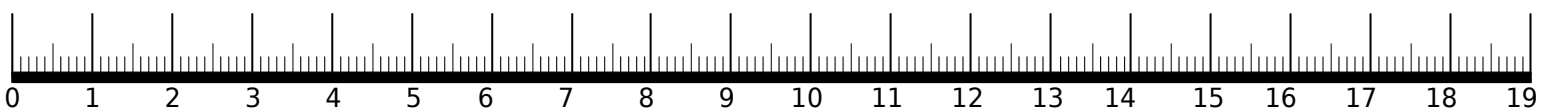
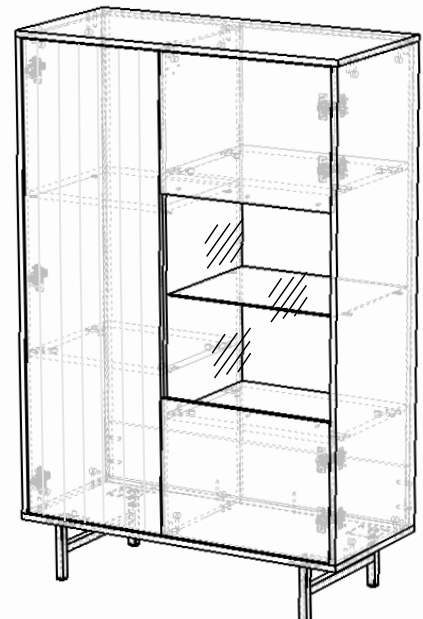

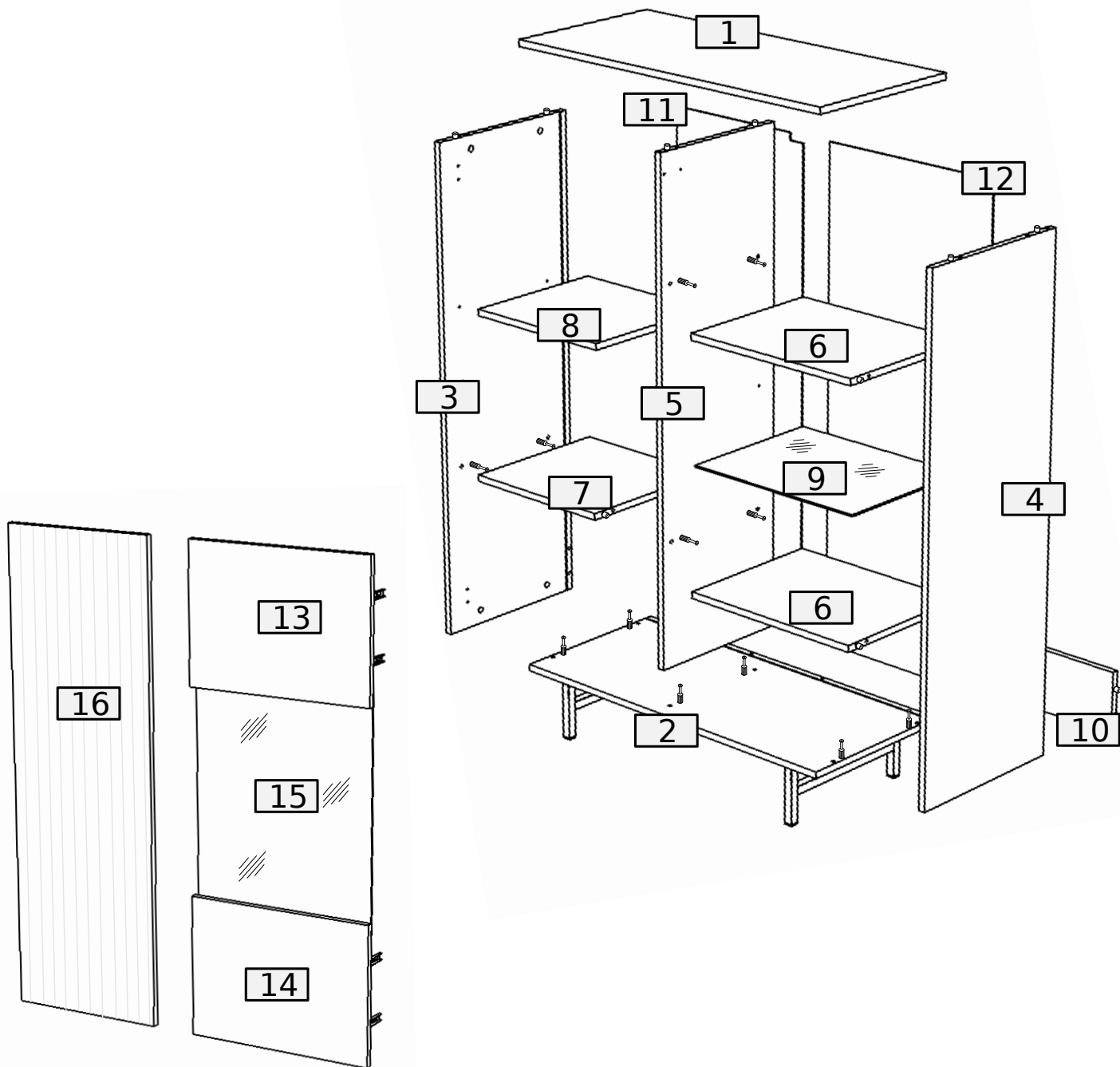

No.	Pcs.	L	W	D	Pac
1	1	900	410	16	2/2
2	1	900	410	16	2/2
3	1	1218	409	16	1/2
4	1	1218	409	16	1/2
5	1	1218	370	16	1/2
6	2	465	370	16	2/2
7	1	385	370	16	2/2
8	1	385	360	16	2/2
9	1	464	350	4	2/2
10	1	866	150	16	2/2
11	1	1232	399	3	1/2

No.	Pcs.	L	W	D	Pac
12	1	1232	479	3	1/2
13	1	470	350	16	2/2
14	1	470	350	16	2/2
15	1	572	460	4	2/2
16	1	1212	390	16	1/2



BOX 1/2

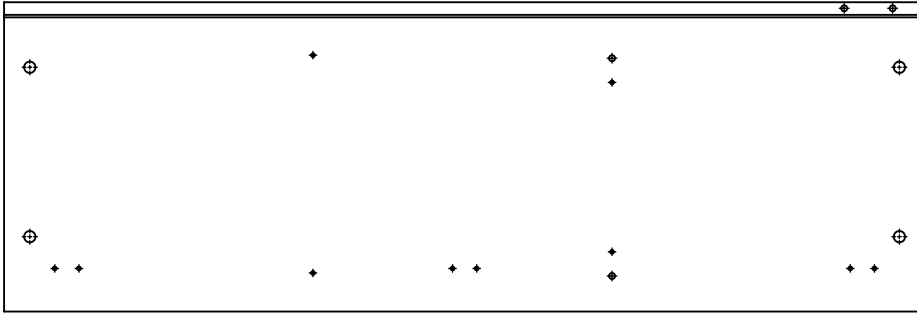

3. 1218x409x16 mm

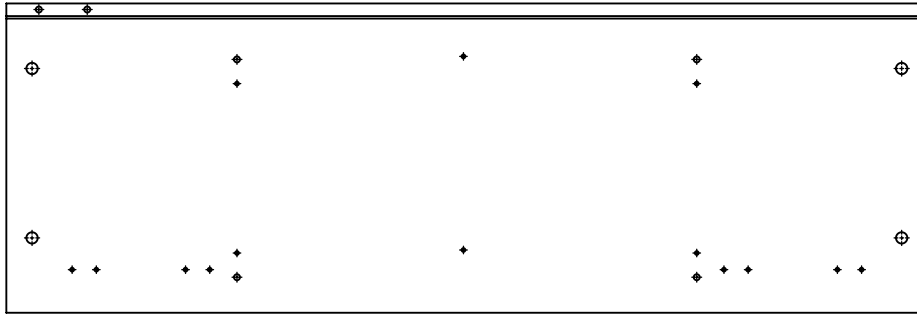

4. 1218x409x16 mm

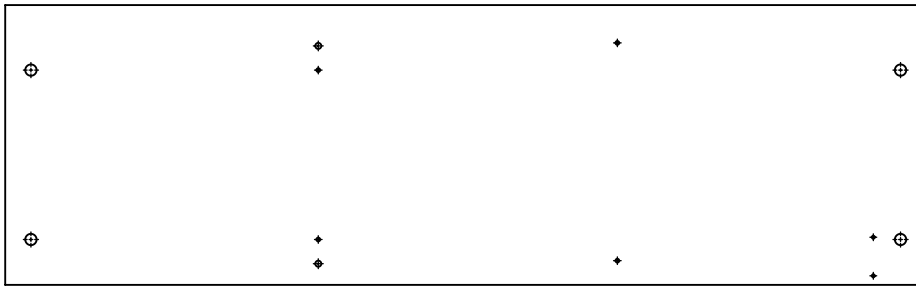

5. 1718x370x16 mm

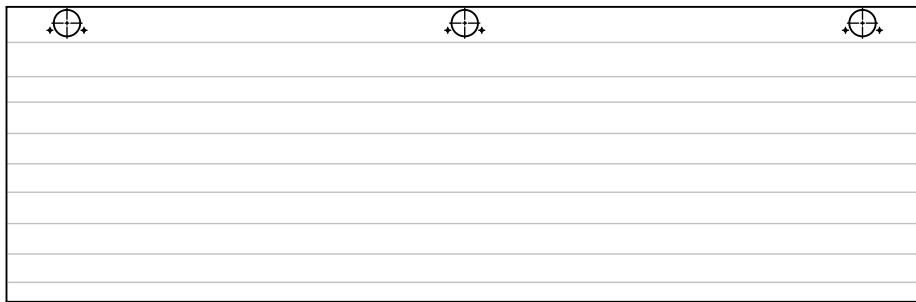

16. 1212x390x16 mm



11. 1232x399x16 mm

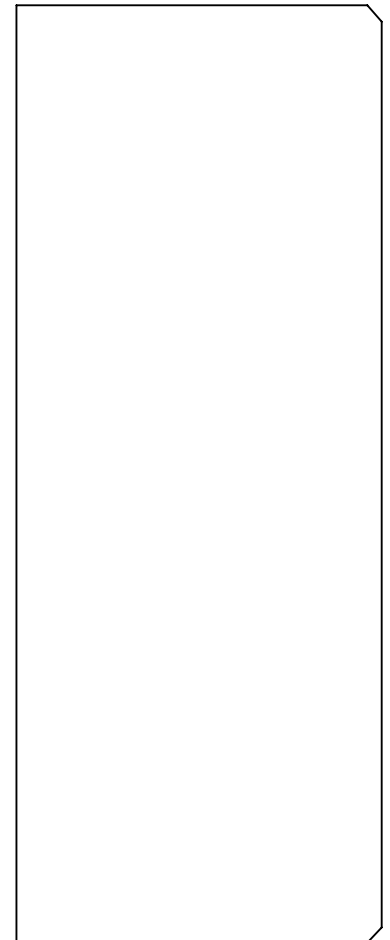

12. 1232x479x16 mm

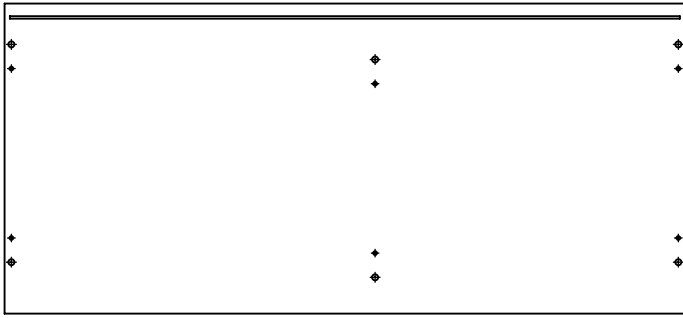

1. 900x410x16 mm

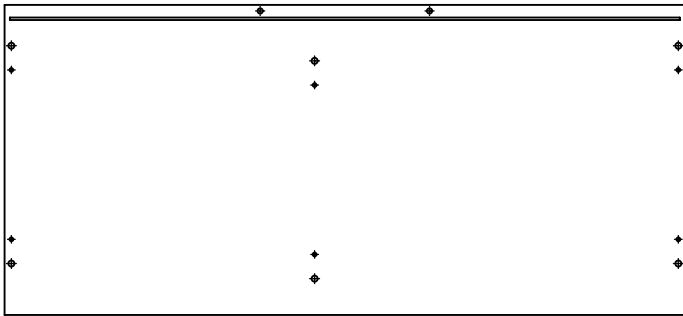

2. 900x410x16 mm

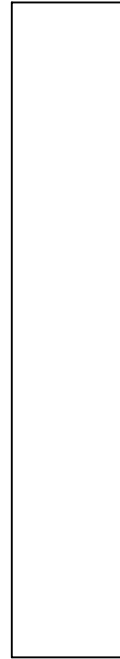

10. 866x150x16 mm

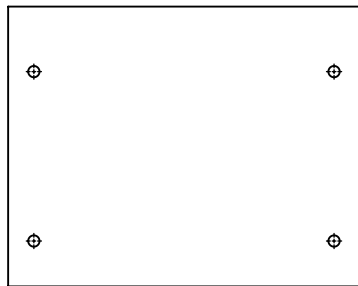

6. 465x370x16 mm x2

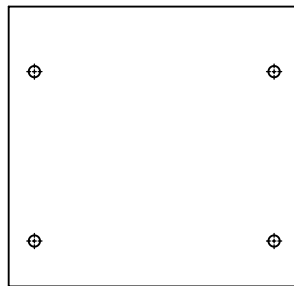

7. 485x370x16 mm

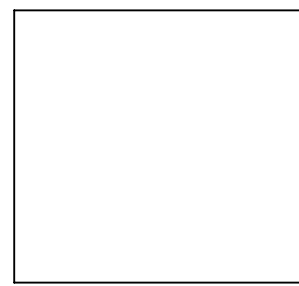

8. 485x360x16 mm



9. 464x350x4 mm

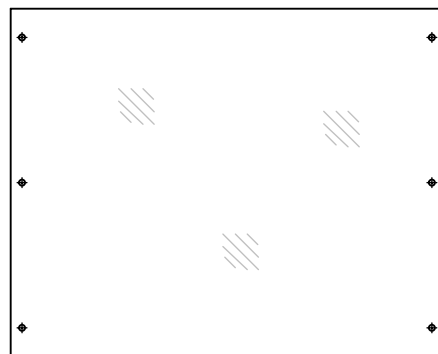

9. 572x460x4 mm

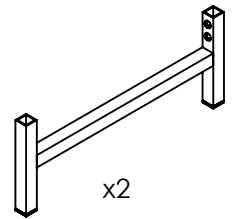

x2

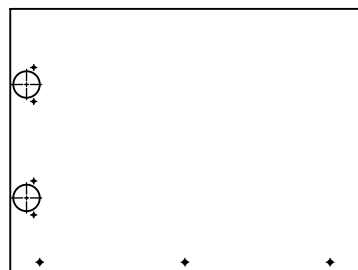

13. 470x350x16 mm

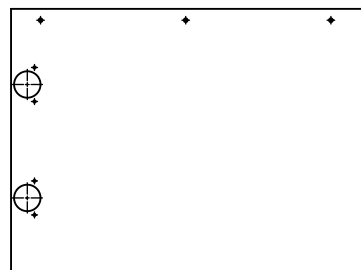

14. 470x350x16 mm

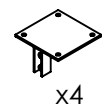

x4

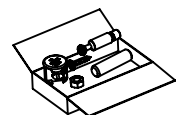

①

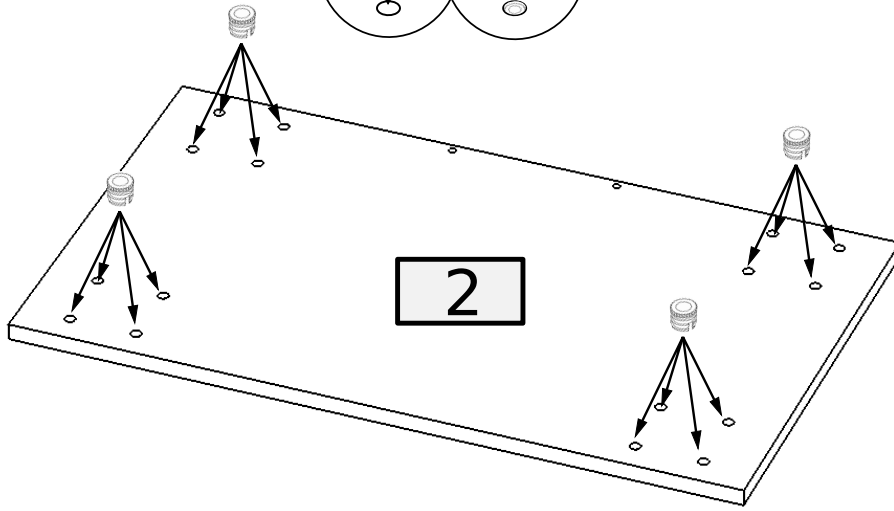
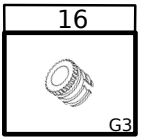
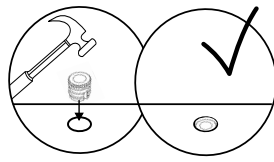

②

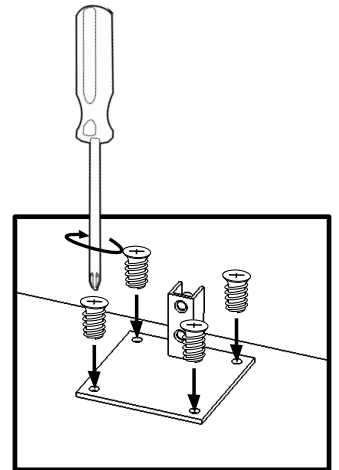
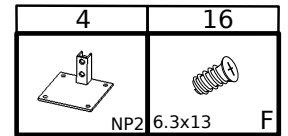
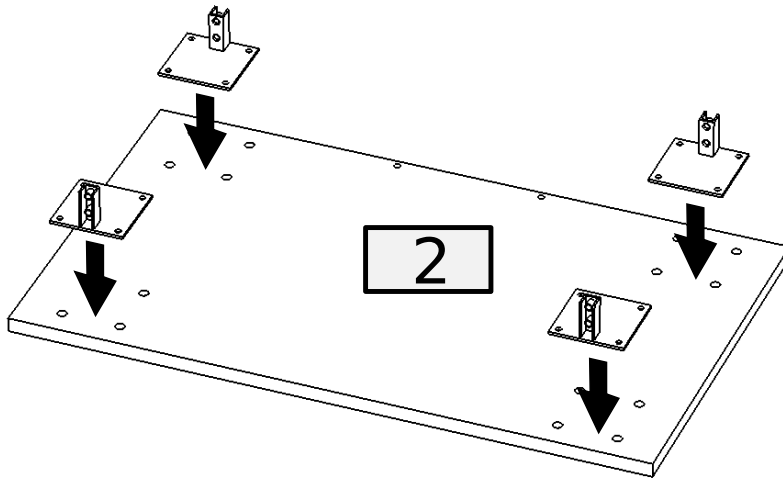

③

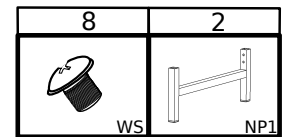
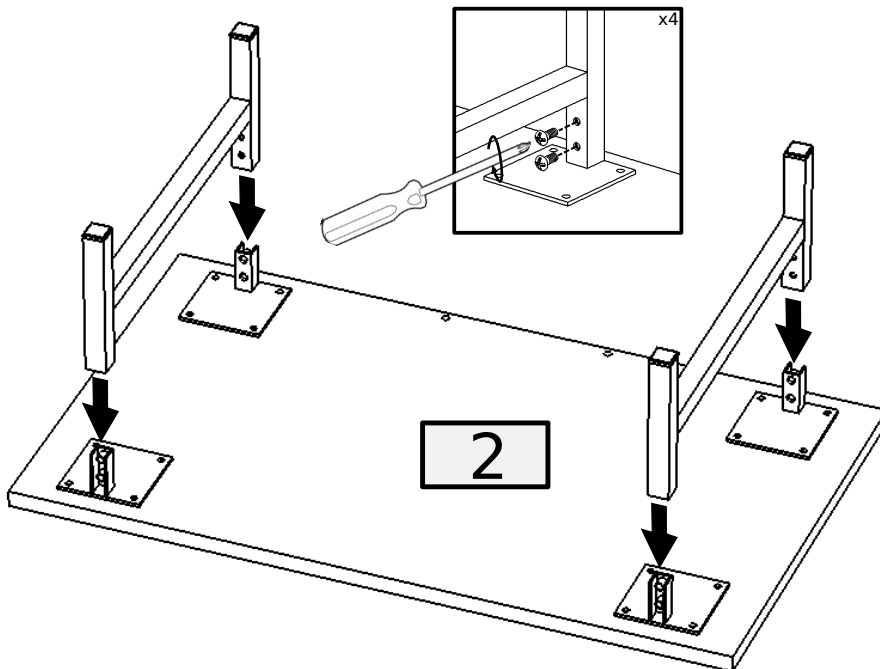

④

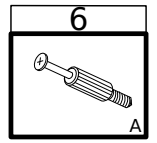
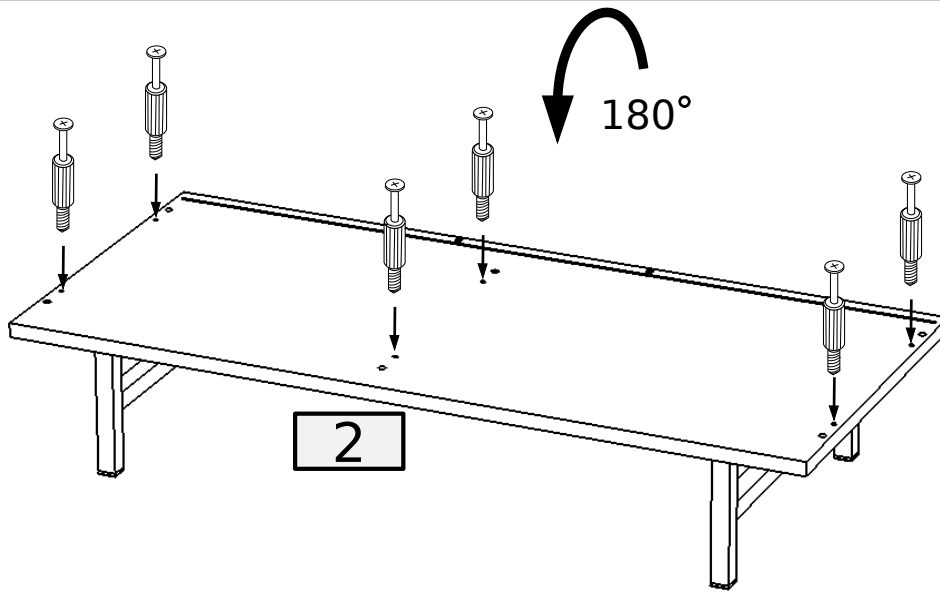

⑤

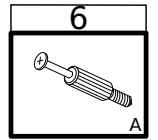
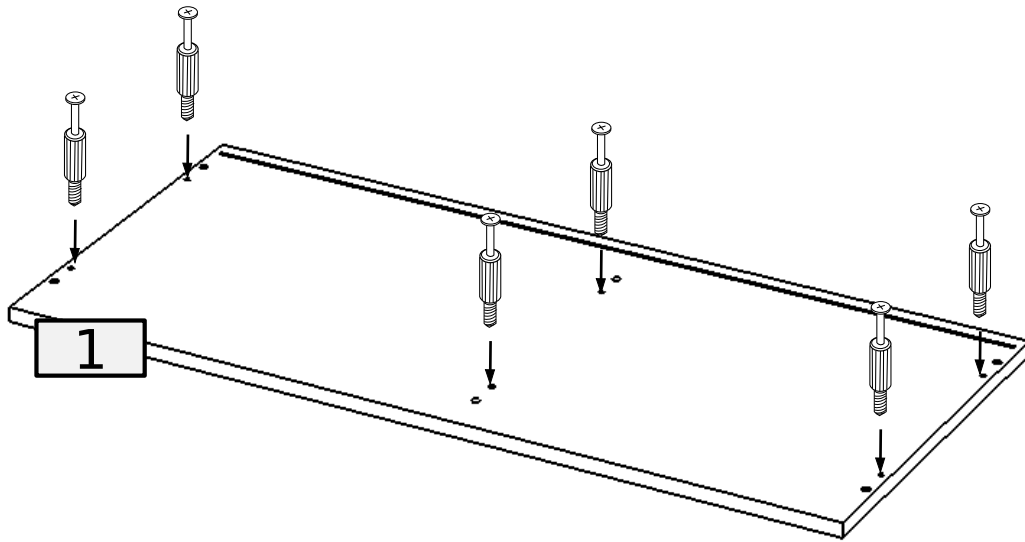

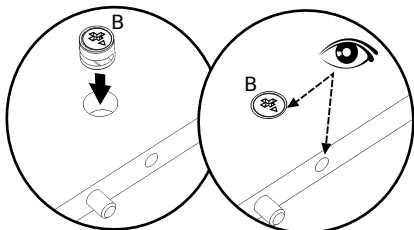
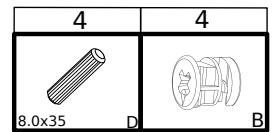
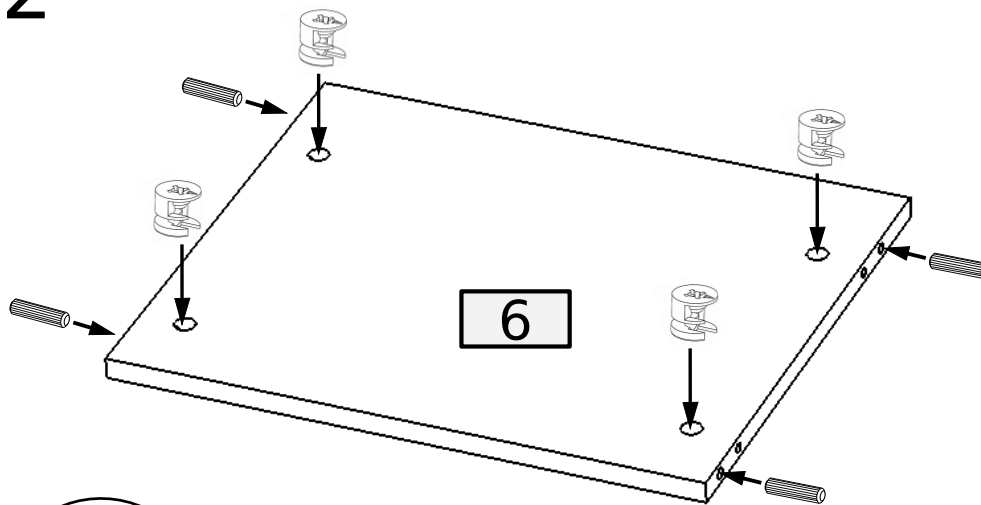

⑥x2

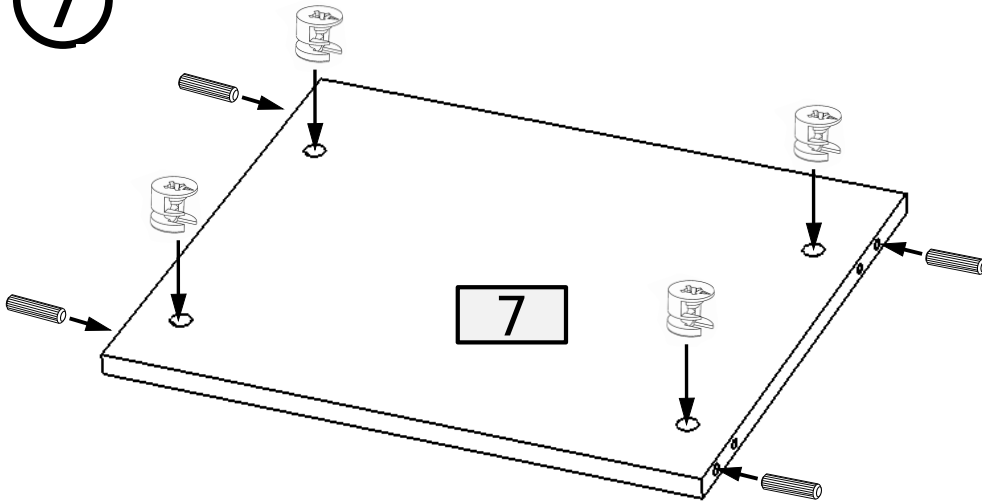

7



4	4
	
8.0x35	D B

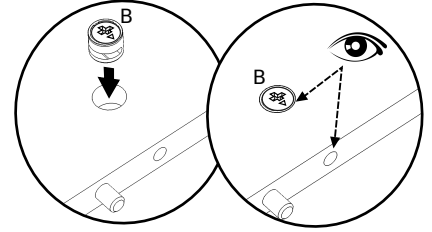

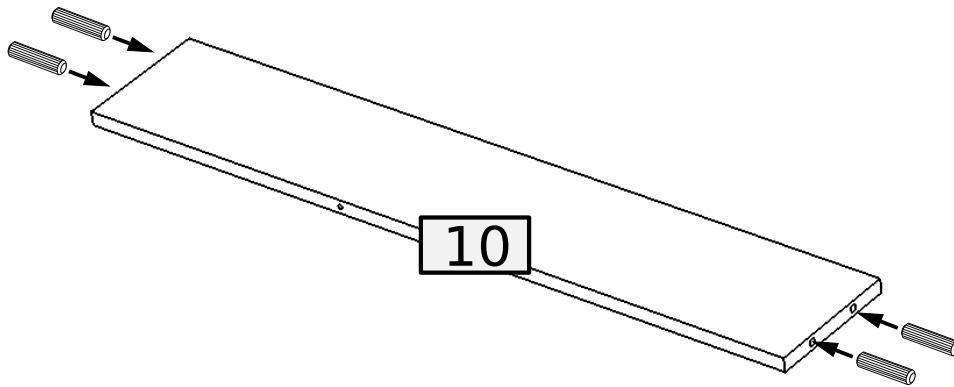

8

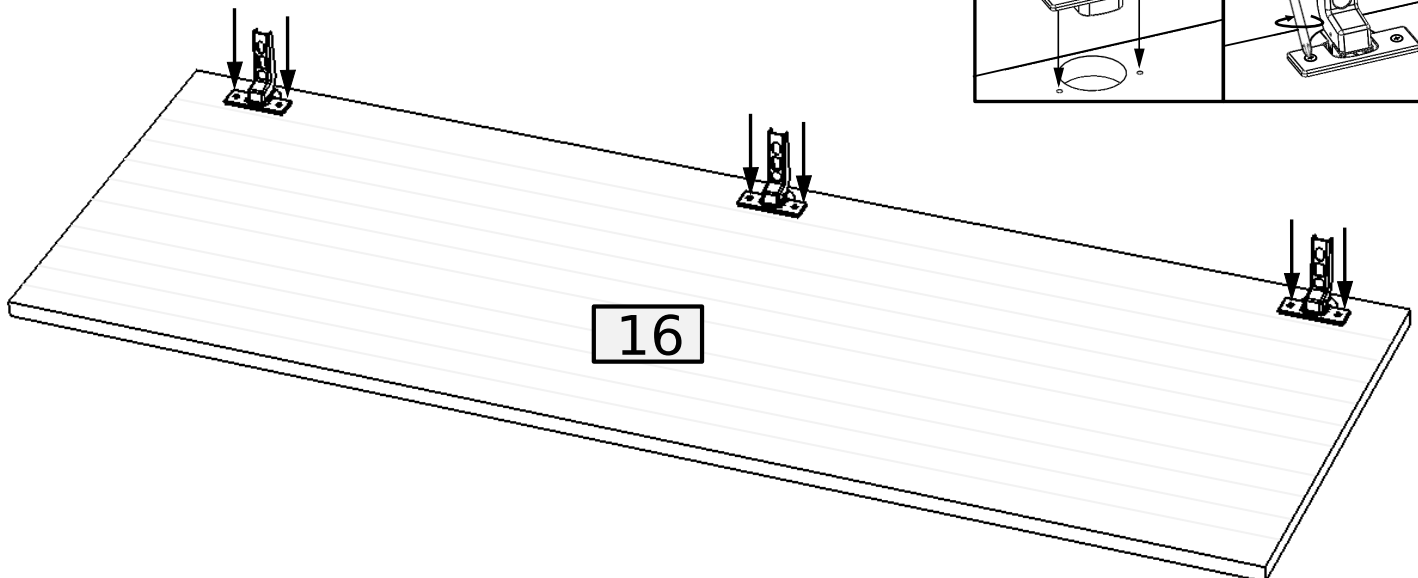

4

8.0x35

9



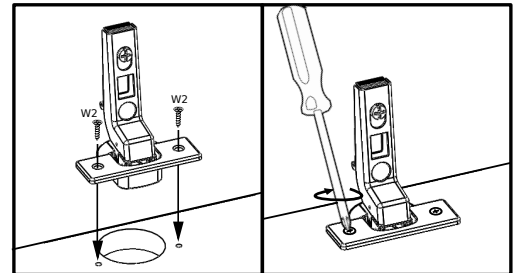

	
3.5x16 W2	Z
6	3



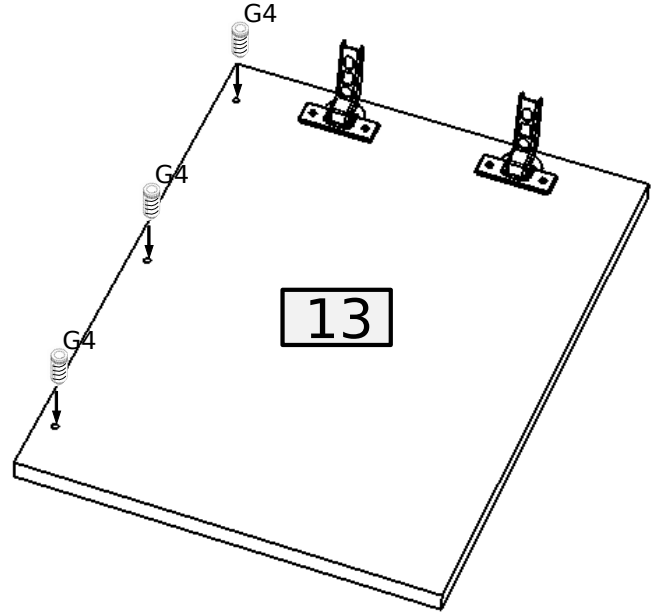
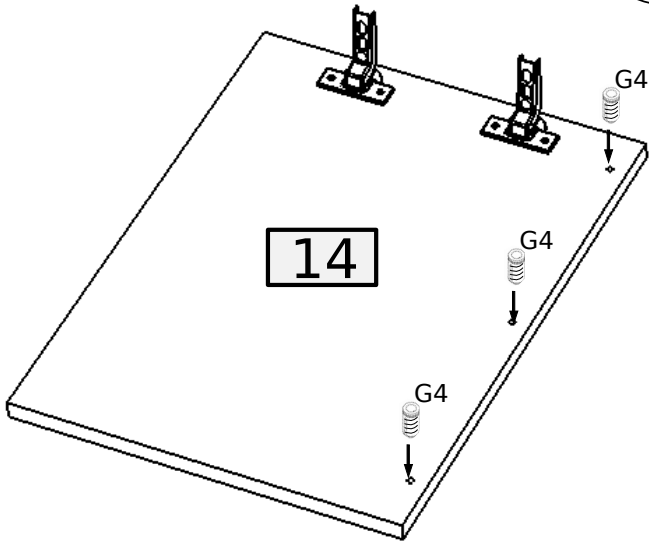
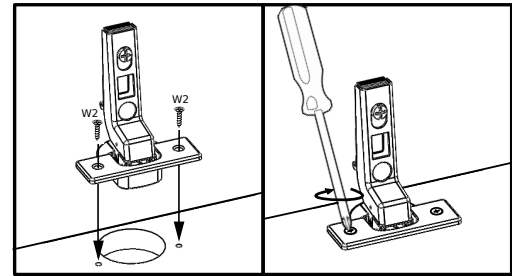
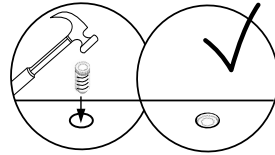

10



		
G4	3.5x16 W2	Z
6	8	4

11

	
3.5x16	W4T
6	6

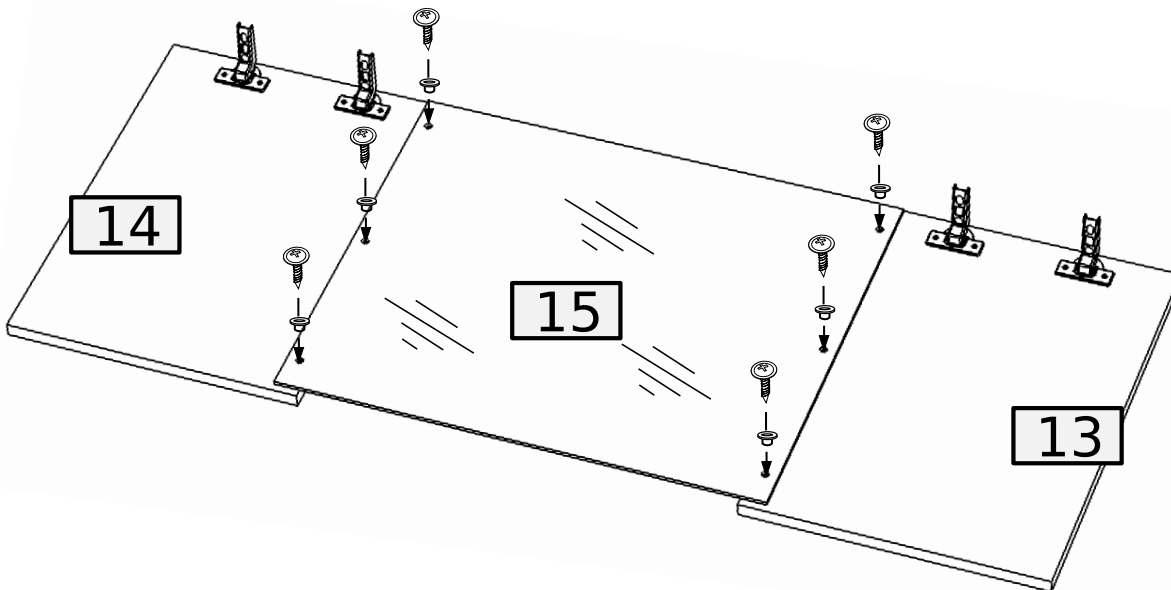

12

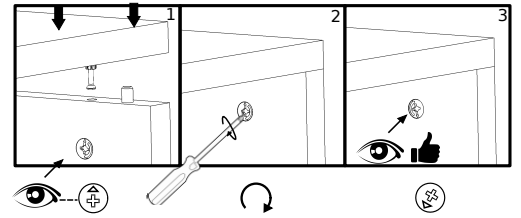
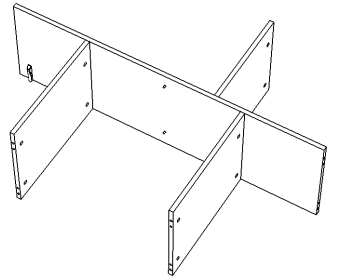
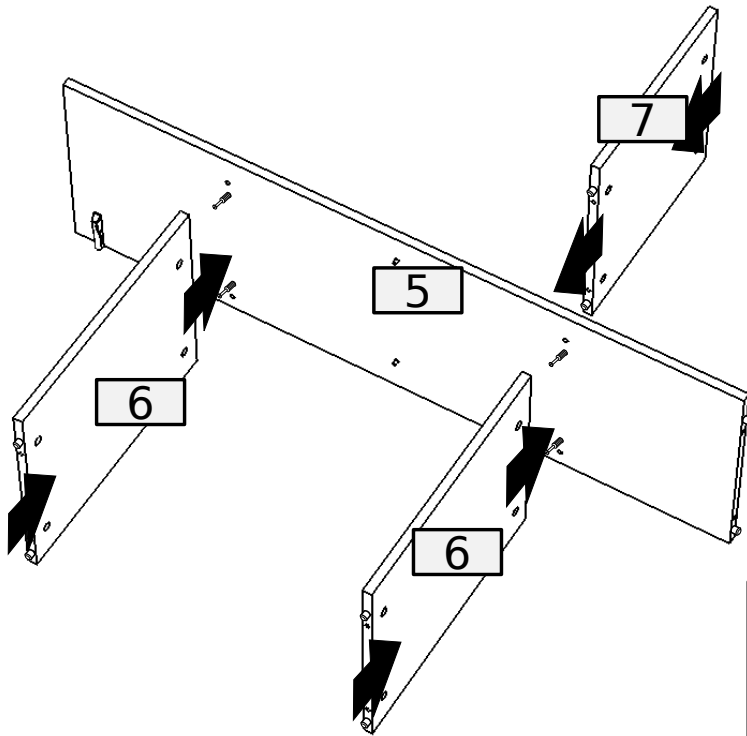

13

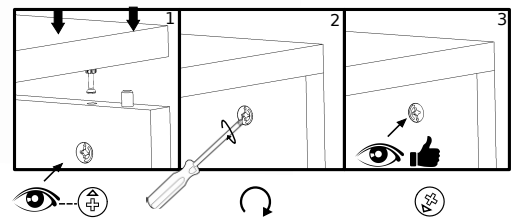
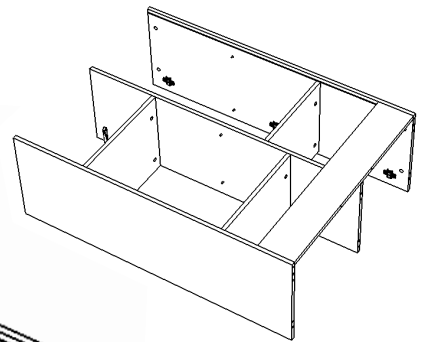
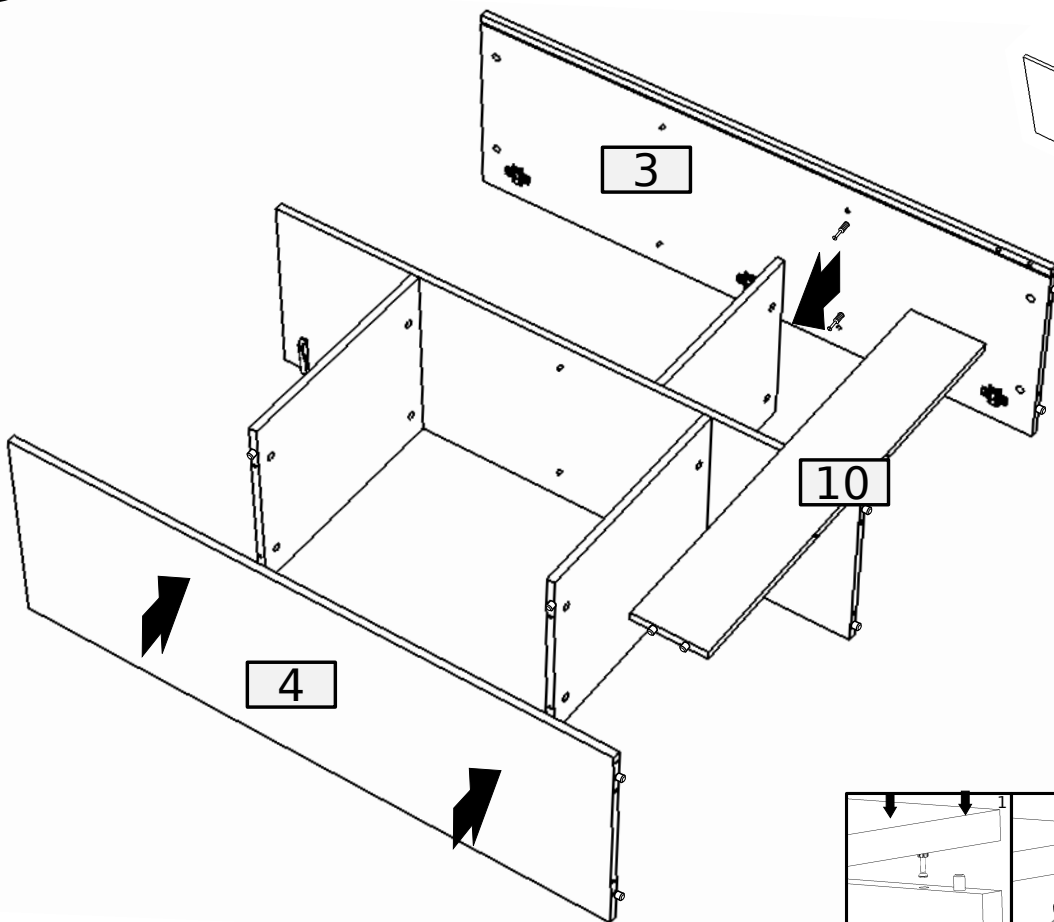

14

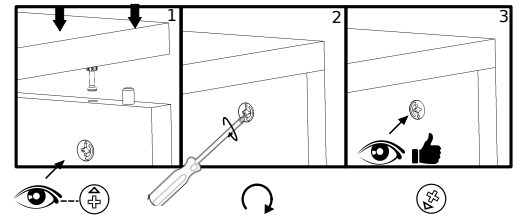
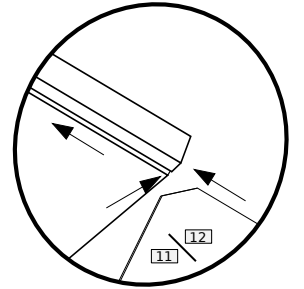
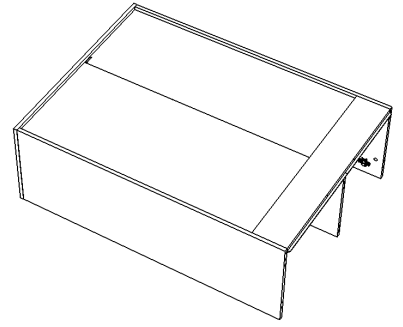
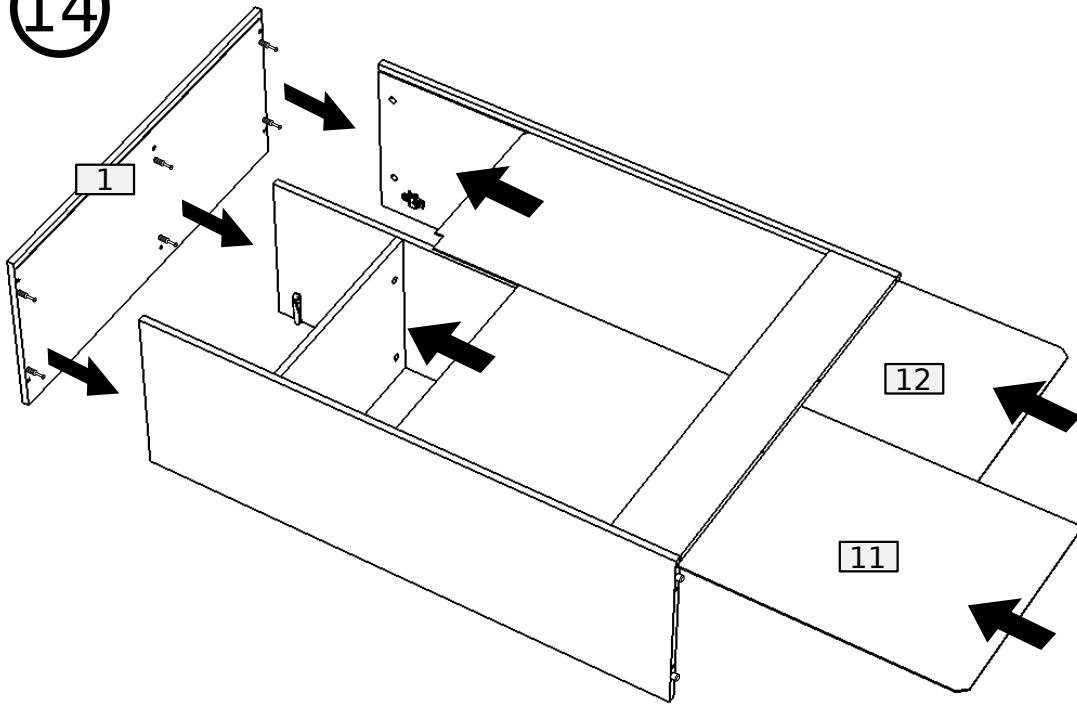

15

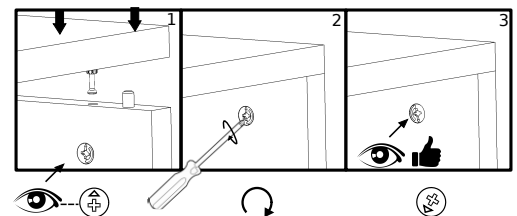
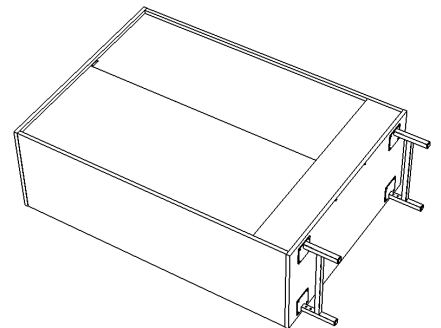
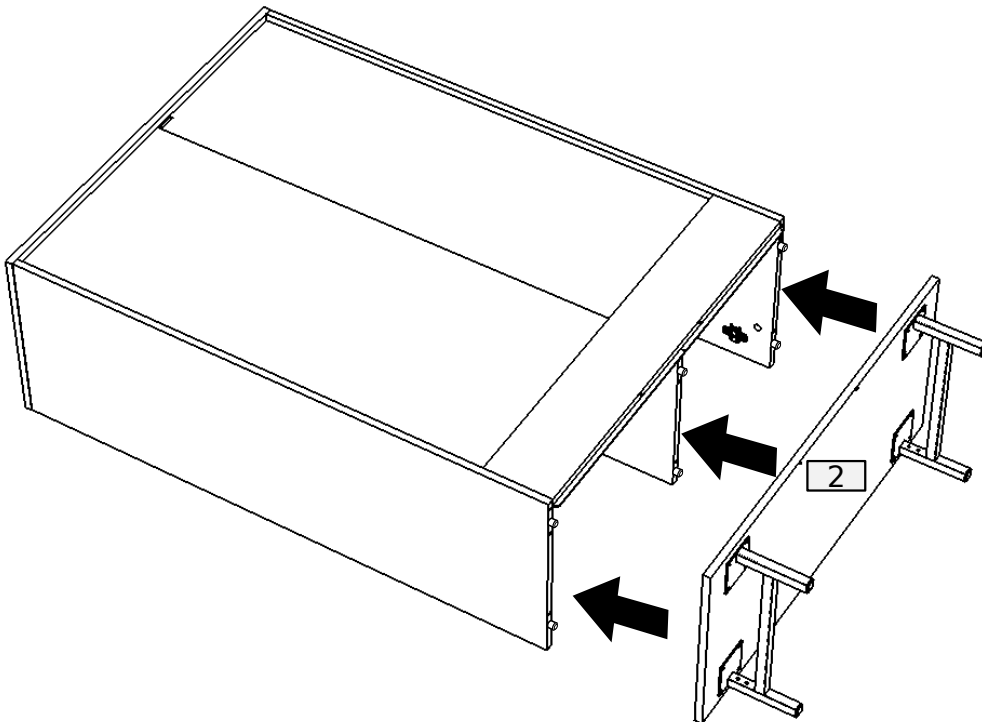

16

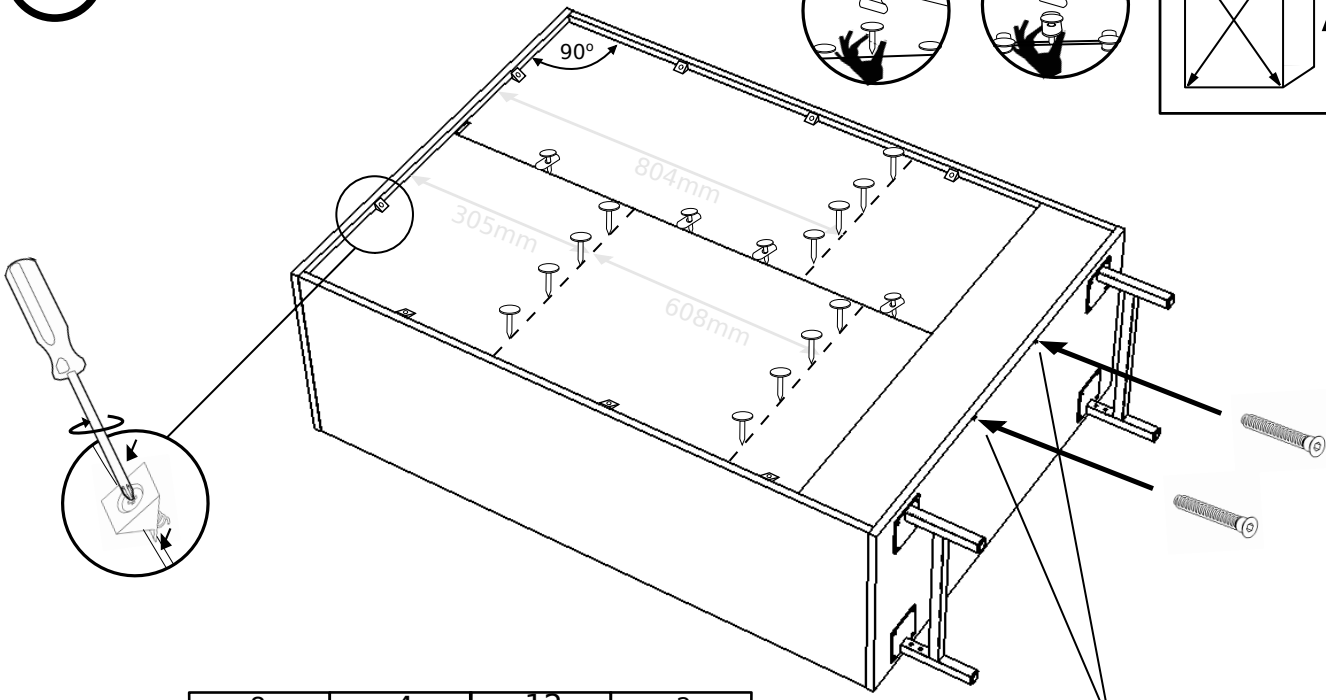
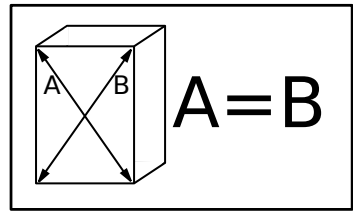
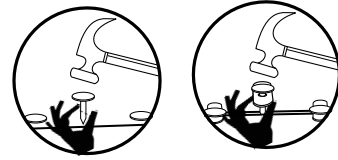

8	4	12	2
	G2	G	O

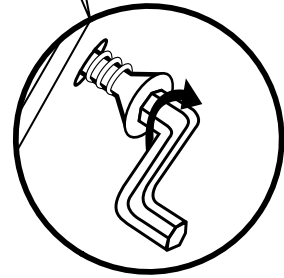

17

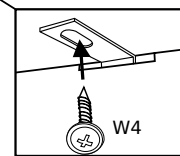
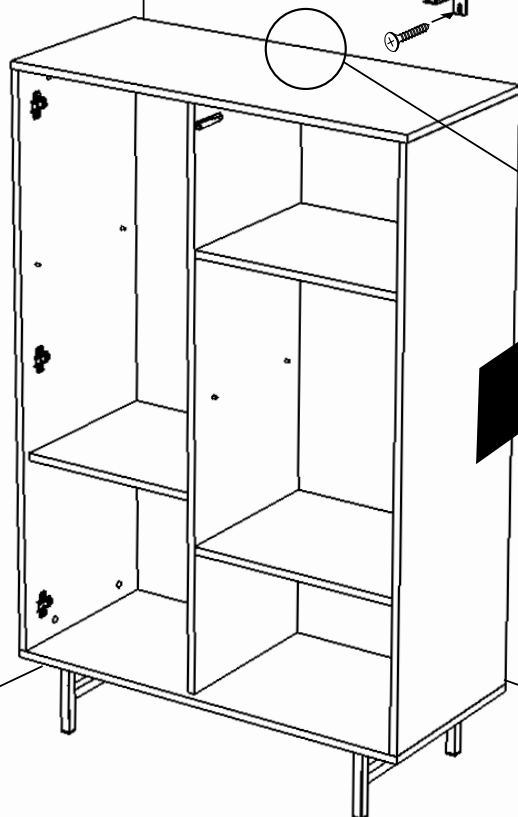
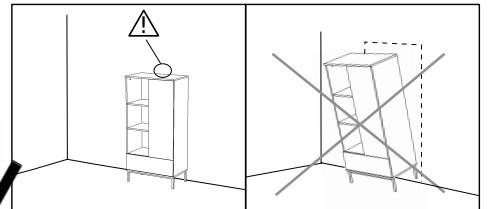
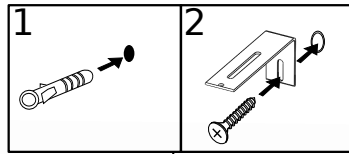

1	1
3.5x16	W4 KS

18

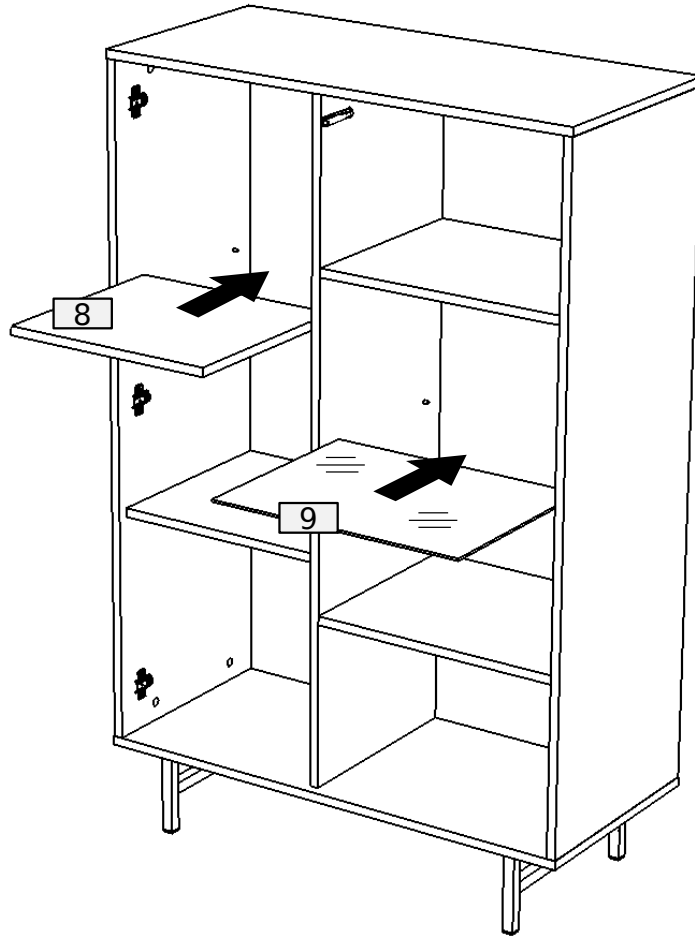

19

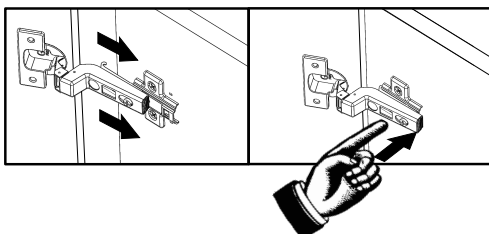
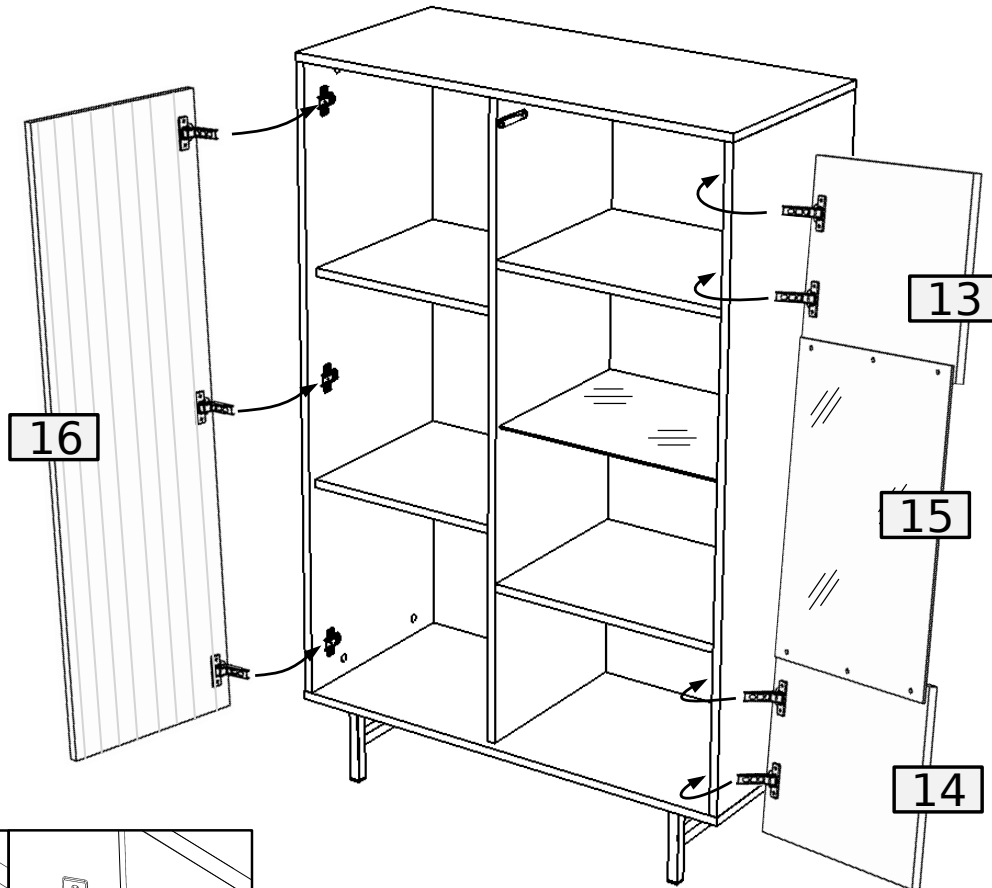

20

