

VÁŽENÝ KLIENTE, JAK PŘI MONTÁŽI ZJISTÍTE POŠKOZENÍ NEBO CHÝBĚJÍCÍ ČÁST, PROSÍME PODAT JEJÍ KÓD ANEB ZAZNAČIT DO NÁVODU MONTÁŽE A POSLAT SPOLU Z REKLAMAČNÍM PROTOKOLEM.

VÁŽENÝ KLIENT, AK POČAS MONTÁŽE ZJISTÍTE POŠKODENIE ALEBO CHÝBAJÚCU ČÁST, PROSÍME PODAŤ JEJ KÓD ALEBO ZAZNAČIŤ DO NÁVODU MONTÁŽE A POSLAŤ SPOLU S REKLAMAČNÝM PROTOKOLOM.

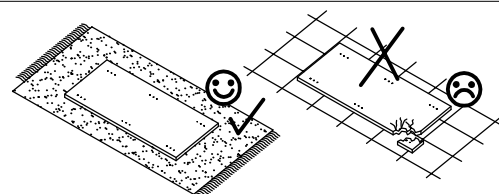

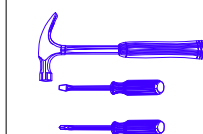

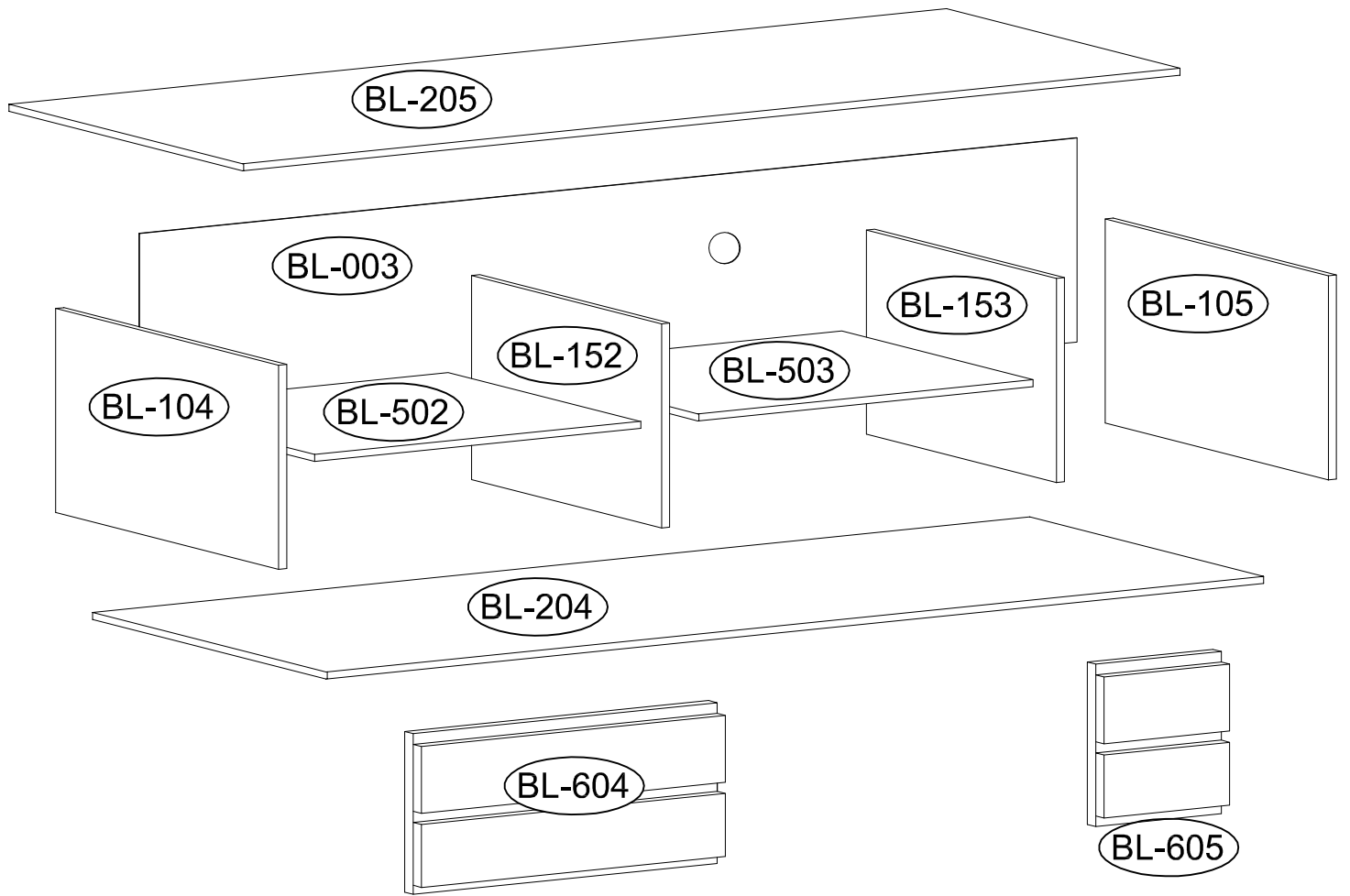

SZANOWNY KLIENCIE, JEŚLI PODCZAS MONTAŻU STWIERDZISZ USZKODZENIE LUB BRAK CZĘŚCI, PROSZĘ PODAJ JEJ KOD LUB ZAZNACZ JĄ NA INSTRUKCJI MONTAŻU I PRZEŚLIJ WRAZ Z PROTOKOLEM REKLAMACYJNYM

*Instrukcja montażu*  
*Montageanleitung*  
*Instructions D'assemblage*  
*Assembly instructions*  
*Návod na montáž*  
*Montážni návod*

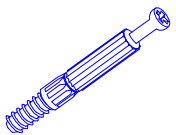
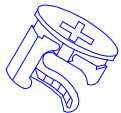

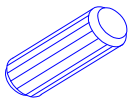
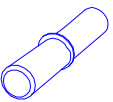
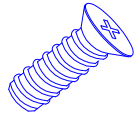
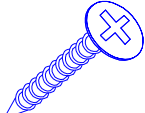
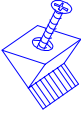
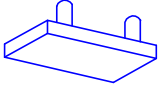
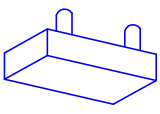
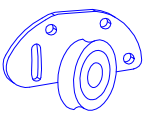
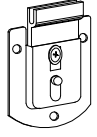
MONTOWAĆ NA MIĘKKIM PODŁOŻU TYPU: KOC, DYWAN.  
 MONTOVAT NA MĚKKÉ PODŁOŽCE TYPU: DEKA, KOBEREK.  
 MONTOVAŤ NA MÄKKEJ PODŁOŽKE TYPU: DEKA, KOBEREK.

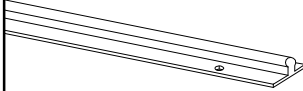

 Ø6.5x36.5mm A-16	 Ø15x16mm B-16	 Ø20 C-16	 Ø8x30mm D-16
 W-8	 Ø6.3x13mm X-4	 Ø4,0x16mm L-28	 ST-12
 S-8	 H-20 mm SS-2	 B1-4	 B2-4
 PK-1	 TR-2	 Ø3,0x13mm T1-20	

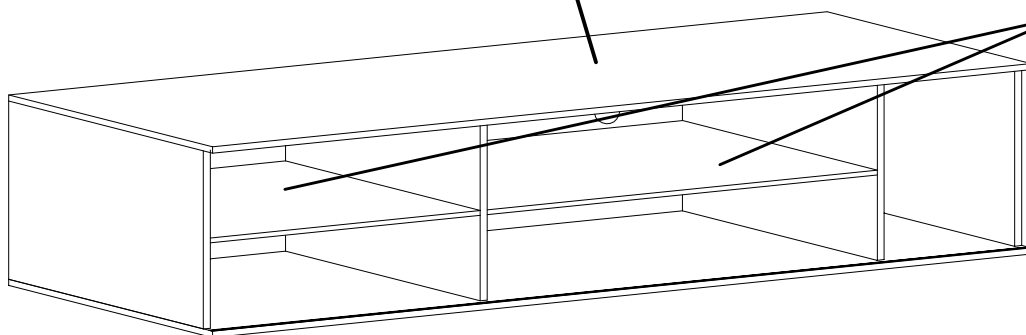
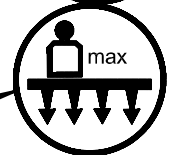
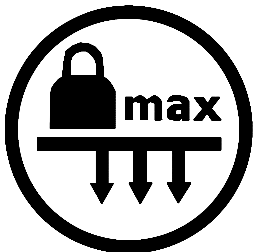

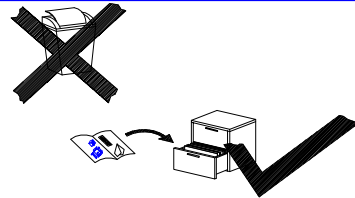
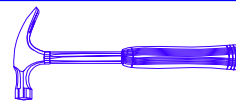
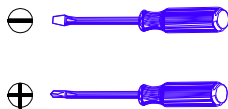
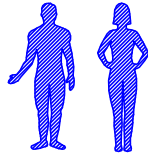
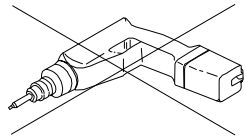

PL: WAŻNE INFORMACJE. Przed użyciem produktu należy dokładnie zapoznać się ze wskazówkami bezpieczeństwa. Należy zapoznać się z instrukcją obsługi i zachować ją do użytku w przyszłości.

GB: IMPORTANT INFORMATION!

Please read the entire manual carefully before starting to assemble and/or using this product. Follow the manual thoroughly and keep it for further reference.

FR: INFORMATIONS IMPORTANTES

Veuillez lire attentivement l'ensemble du manuel avant de commencer à monter et/ou utiliser ce produit.

Suivez rigoureusement le manuel et conservez-le pour toute consultation ultérieure.

SK: DŮLEŽITÉ INFORMÁCIE!

Predtým ako začnete s montážou a/alebo používaním tohto produktu si pozorne prečítajte celý návod. Návod dôsledne dodržiavajte a ponechajte si ho pre použitie v budúcnosti

CZ: DŮLEŽITÉ INFORMACE!

Před sestavením nebo použitím výrobku si pečlivě přečtěte celý návod. Dodržujte důsledně uvedené pokyny a návod uschovejte, aby byl k dispozici v případě potřeby.

PL: WAŻNE! Ważne jest, żeby każdy ze skręcanych produktów został ponownie dokręcony w ciągu 2 tygodni od montażu, a następnie sprawdzać co 3 miesiące czy śruby są dokręcone — w celu zapewnienia stabilności przez czas użytkowania produktu.

GB: IMPORTANT!

It is important that any product which is assembled using any kind of screw is re-tightened 2 weeks after assembly, and once every 3 months - in order to assure stability through-out the lifespan of the product.

FR: IMPORTANT

Il est important que tout produit monté à l'aide de vis soit resserré 2 semaines après son montage, puis tous les 3 mois, afin de garantir sa stabilité durant tout son cycle de vie.

CZ: DŮLEŽITÉ!

U každého výrobku, který se sestavuje pomocí jakýchkoli šroubků, je důležité dotáhnout šroubky 2 týdny po sestavení a potom každé 3 měsíce, aby byla zajištěna stabilita po celou dobu životnosti výrobku.

SK: DŮLEŽITÉ!

Je dôležité, aby sa na akomkoľvek produkte, montovanom pomocou akýchkoľvek skrutiek, skrutky dotiahli po dvoch týždňoch od montáže, a jedenkrát v priebehu každých 3 mesiacov - tak sa zaručí stabilita počas celej životnosti produktu.

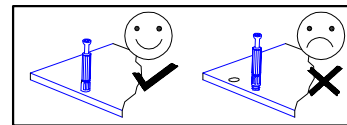

PL: OSTRZEŻENIE WS. USZKODZEŃ Aby uniknąć rys, ten mebel powinien być montowany, składany na miękkim podłożu, np. dywanie.

GB: WARNING TO AVOID SCRATCHES!

In order to avoid scratching this furniture should be assembled on a soft layer - could be a rug.

FR: AVERTISSEMENT POUR ÉVITER LES RAYURES

Afin d'éviter les rayures, ce meuble doit être monté sur une surface souple (un tapis, par exemple).

CZ: VAROVANI TYKAJICI SE POSKRABANI!

Aby nedošlo k poskrabani, sestavujte nabytek na mekkem podkladu - napr. na koberci.

SK: VYSTRAHA TYKAJUCA SA PREDCHADZANIA SKRABANCOM!

Aby sa predišlo skrabancom, tento nabytok by mal montovať na nakkom podklade, napríklad na koberci.

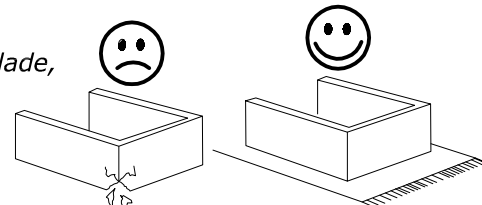

PL: OGÓLNE INSTRUKCJE DOTYCZĄCE MEBLI Z DREWNA ORAZ MATERIAŁÓW DREWNOPOCHODNYCH: MELAMINA, LAMINAT, OKLEINA

Do czyszczenia należy używać wilgotnej ściereczki. Używać wyłącznie wody lub delikatnego detergentu. Wycierać do sucha ściereczką.

GB: GENERAL INSTRUCTION FOR FURNITURE MADE OF WOOD OR WOOD COMPOSITES SUCH AS MELAMINE, LAMINATE OR VENEER SURFACES

Wipe clean with a damp cloth.

Use only water or a gentle detergent. Wipe dry with a clean cloth.

FR: INSTRUCTIONS GÉNÉRALES POUR LE MOBILIER CONSTITUÉ DE BOIS OU DE COMPOSITES DE BOIS

(COMME LES SURFACES EN MELAMINÉ, STRATIFIÉ OU PLACAGE)

Nettoyer à l'aide d'un chiffon humide. Utiliser uniquement de l'eau ou un détergent doux. Essuyer à l'aide d'un chiffon propre.

CZ: OBECNÉ POKYNY TÝKAJÍCÍ SE NÁBYTKU VYROBENÉHO ZE DŘEVA NEBO Z KOMPOZITŮ DŘEVA, NAPŘ. S POUVRCEM Z MELAMINU, LAMINÁTU NEBO DÝHY!

Čistěte otřením navlhčeným hadříkem. Používejte pouze vodu nebo jemný čistící prostředek.

Vytřete dosucha čistým hadříkem.

SK: VŠEOBECNÉ POKYNY PRE NÁBYTKO VYROBENÝ Z DREVA ALEBO KOMPOZITNÝCH MATERIÁLOV, NAPRÍKLAD MELAMÍNU, LAMINÁTU ALEBO PREGLEJKOVÝCH POUVRCHOV!

Utrite dočista navlhčenou utierkou. Používajte iba vodu alebo jemný čistiaci prostriedok.

Utrite dosucha čistou utierkou.

# 1

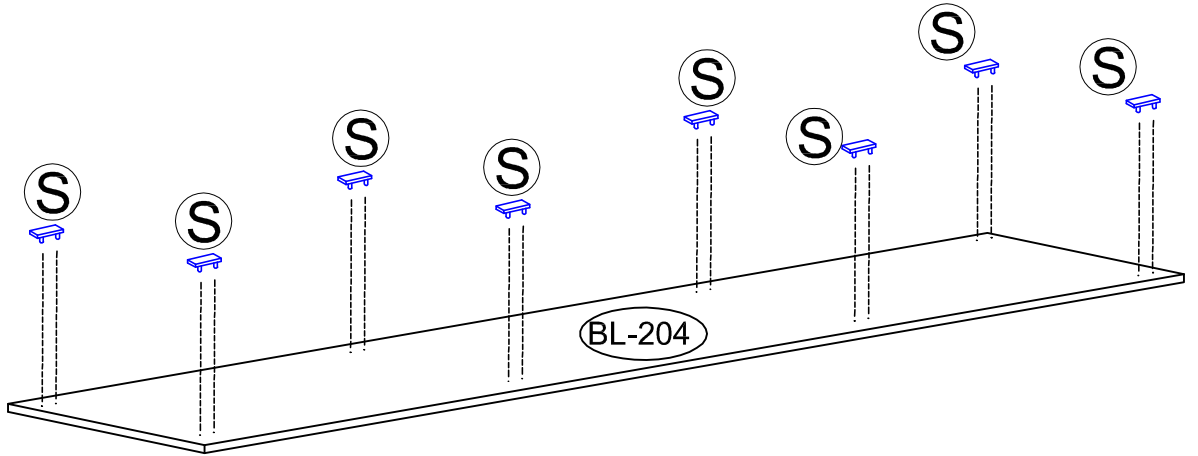
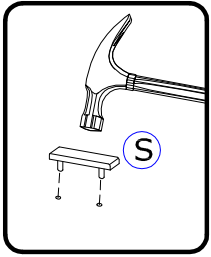
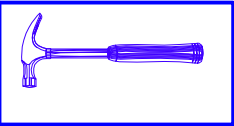
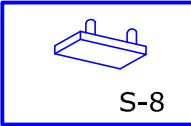

# 2

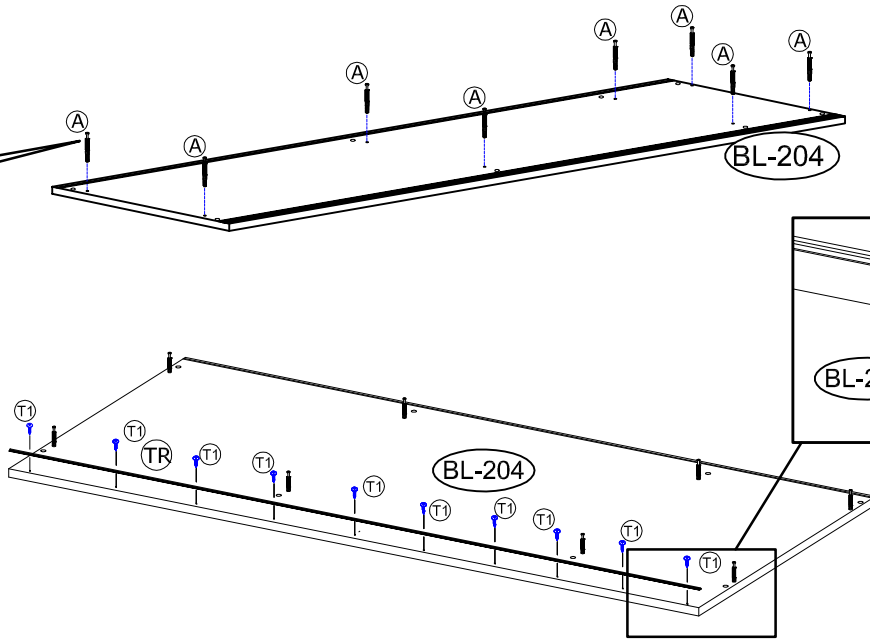
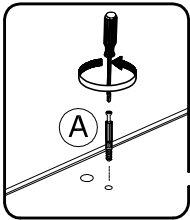
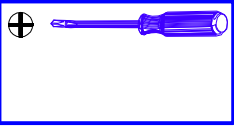
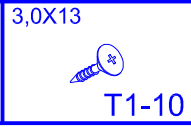
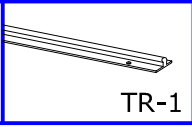
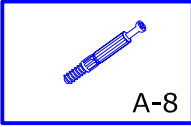

# 3

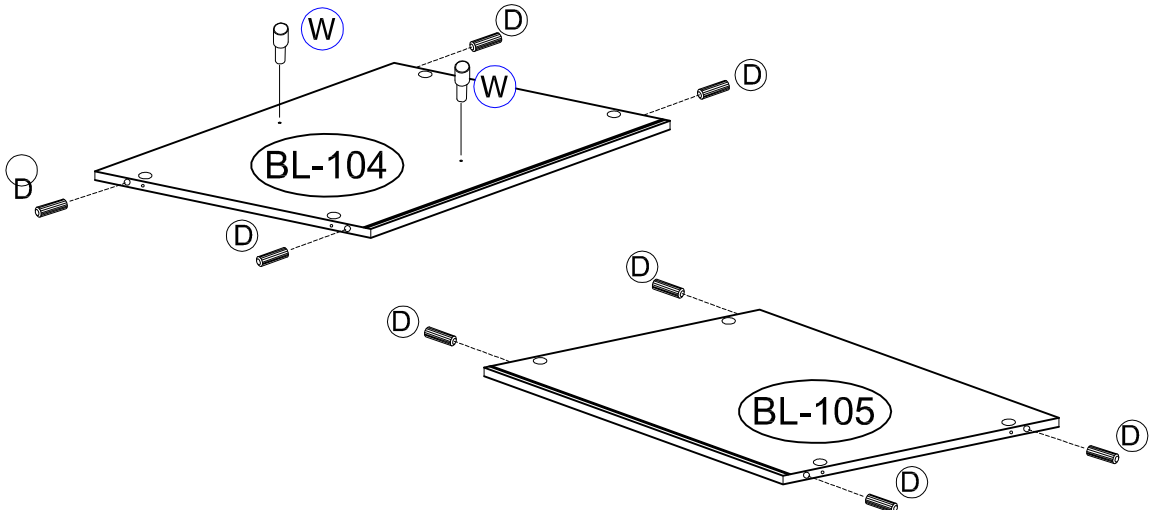
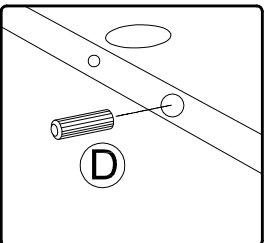
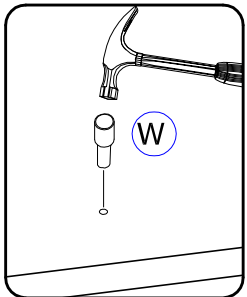
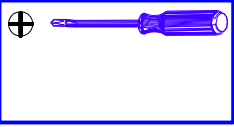
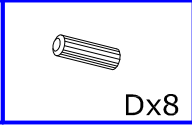
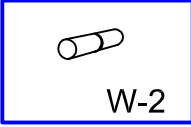

# 4

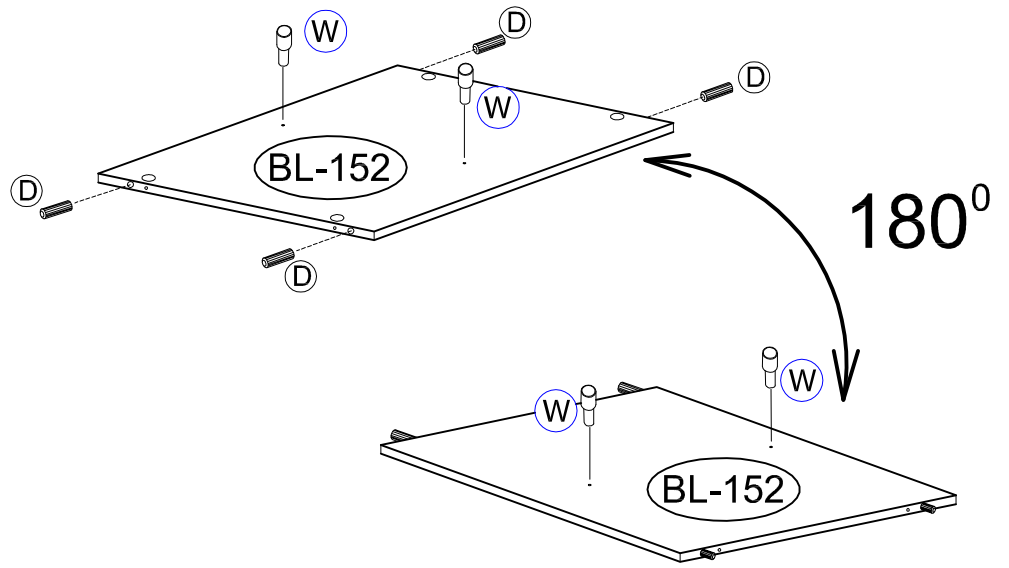
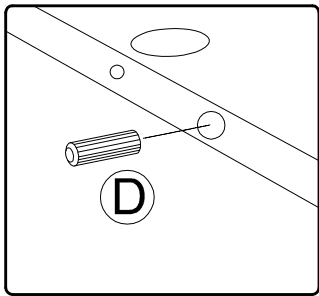
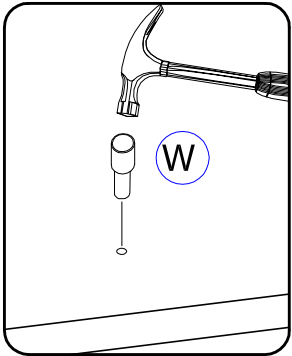

# 5

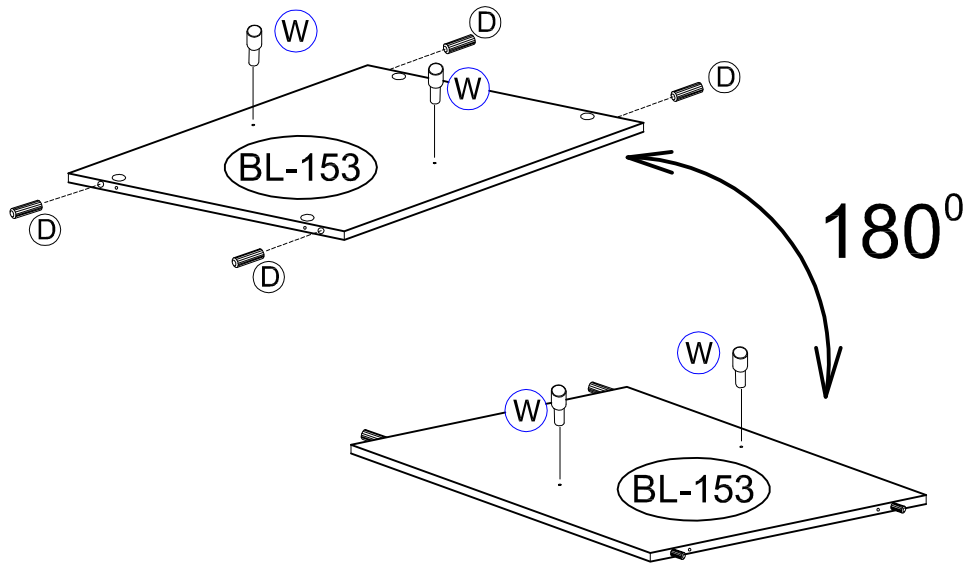
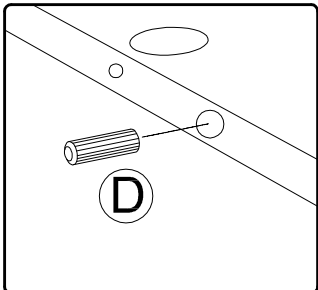
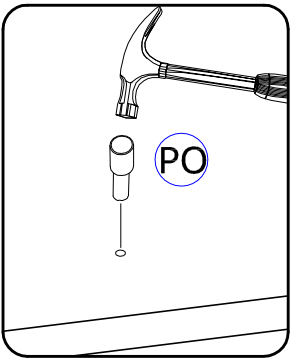

# 6

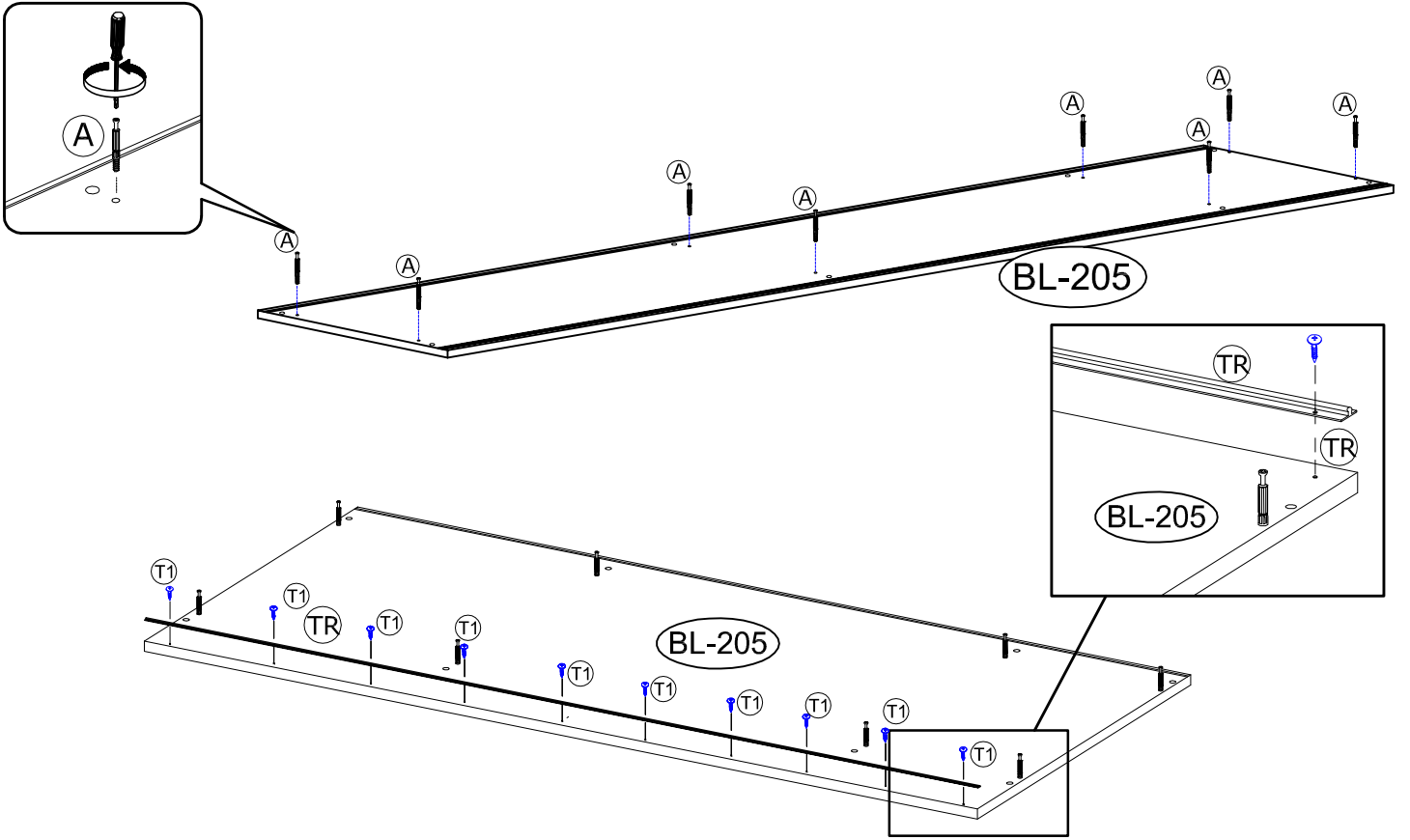

# 7

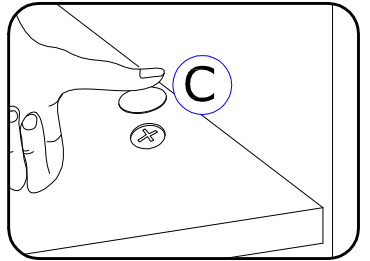
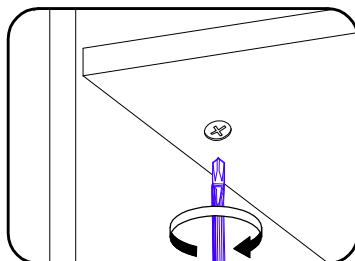
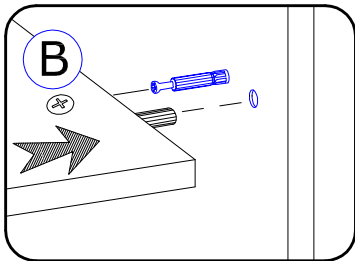
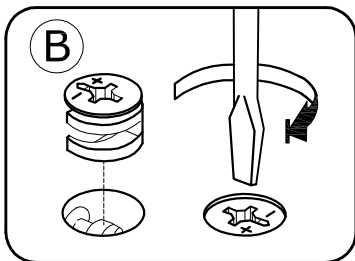
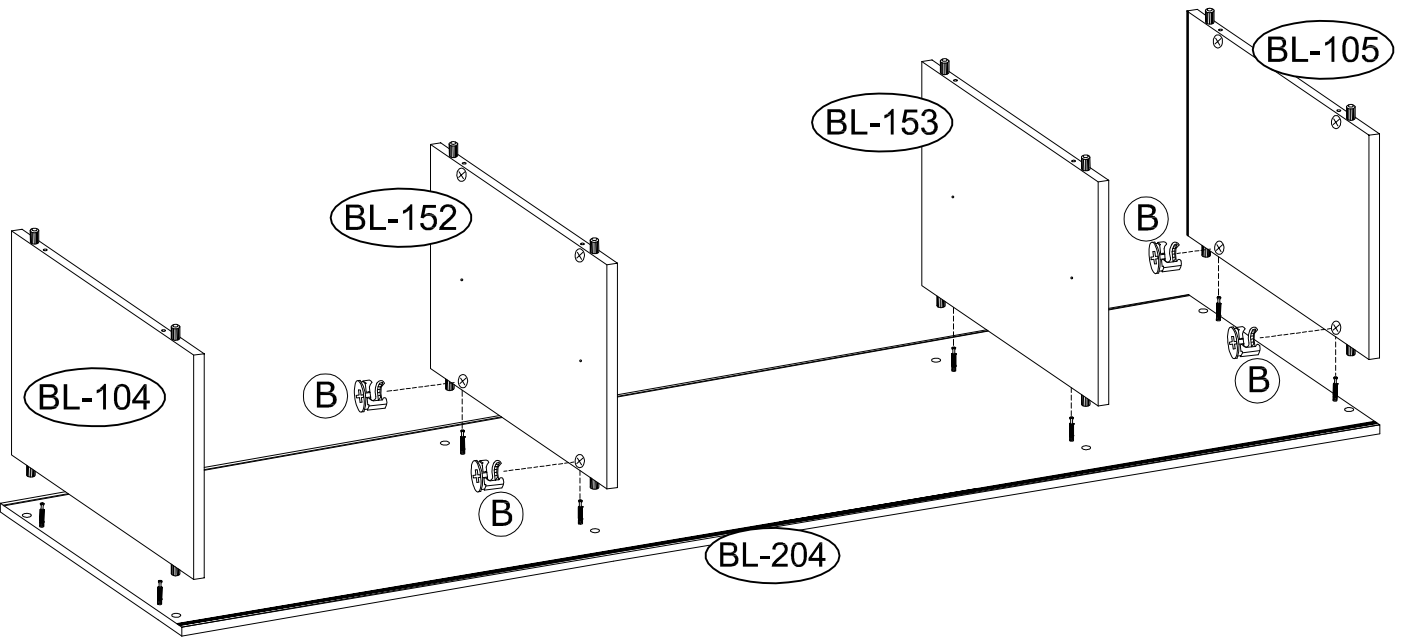

# 8



PK-1

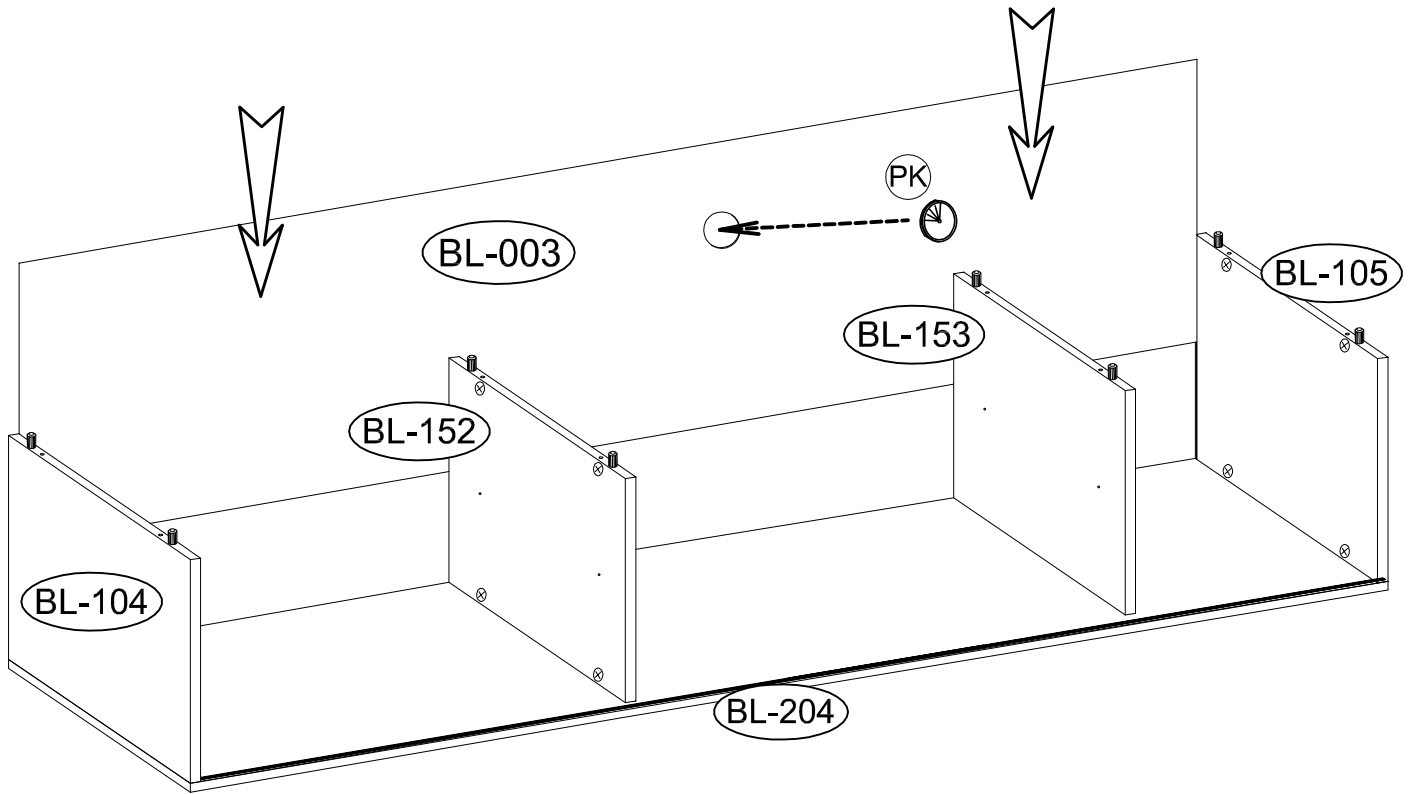

# 9



B-8



C-8

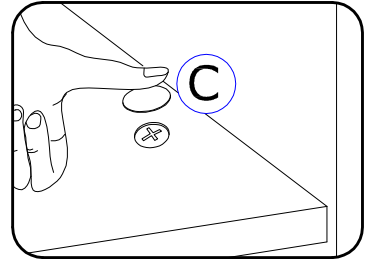
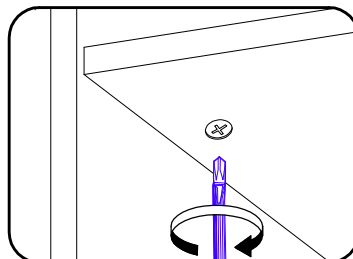
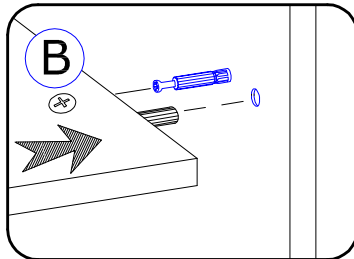
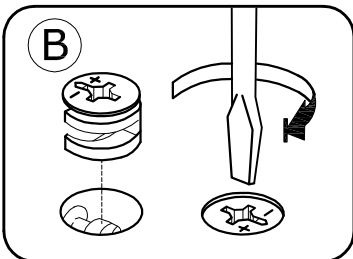
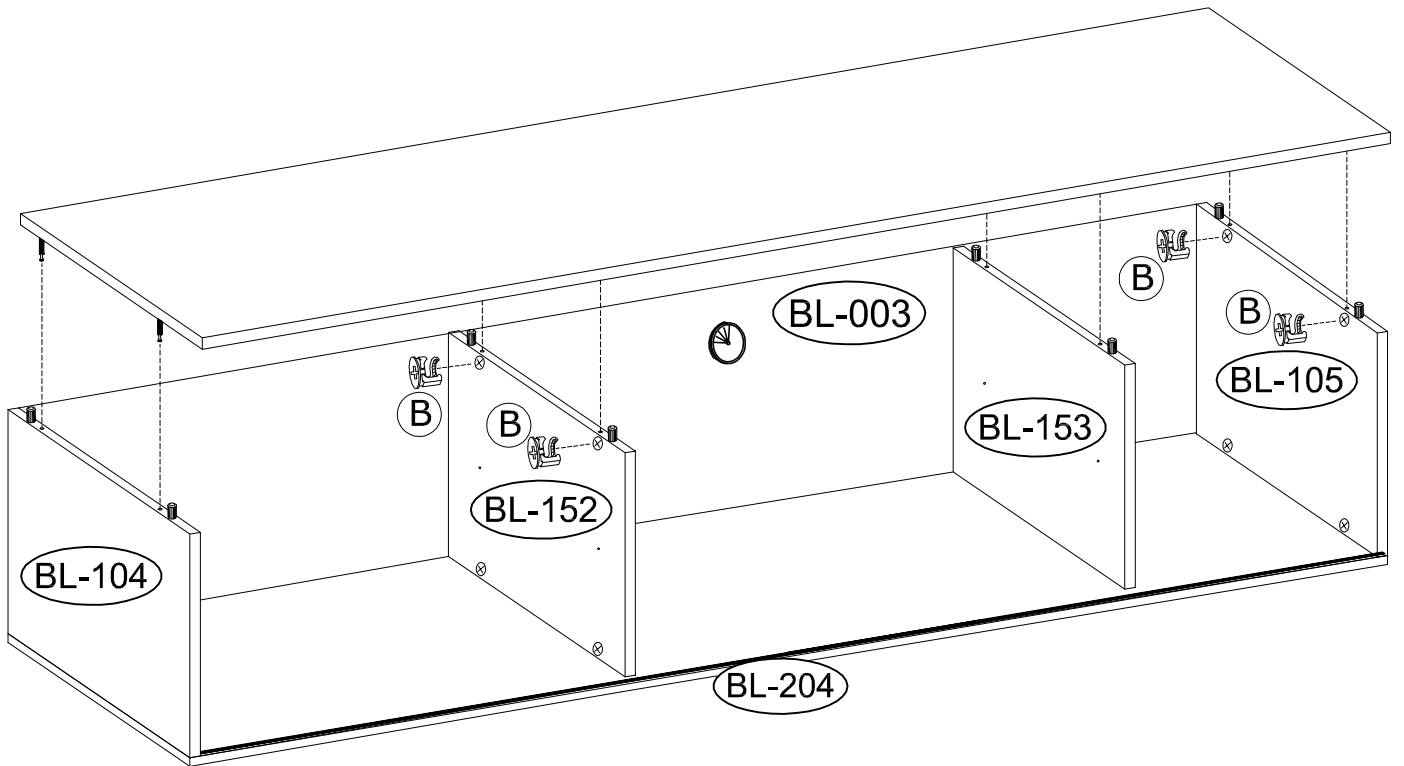



# 10



ST-12

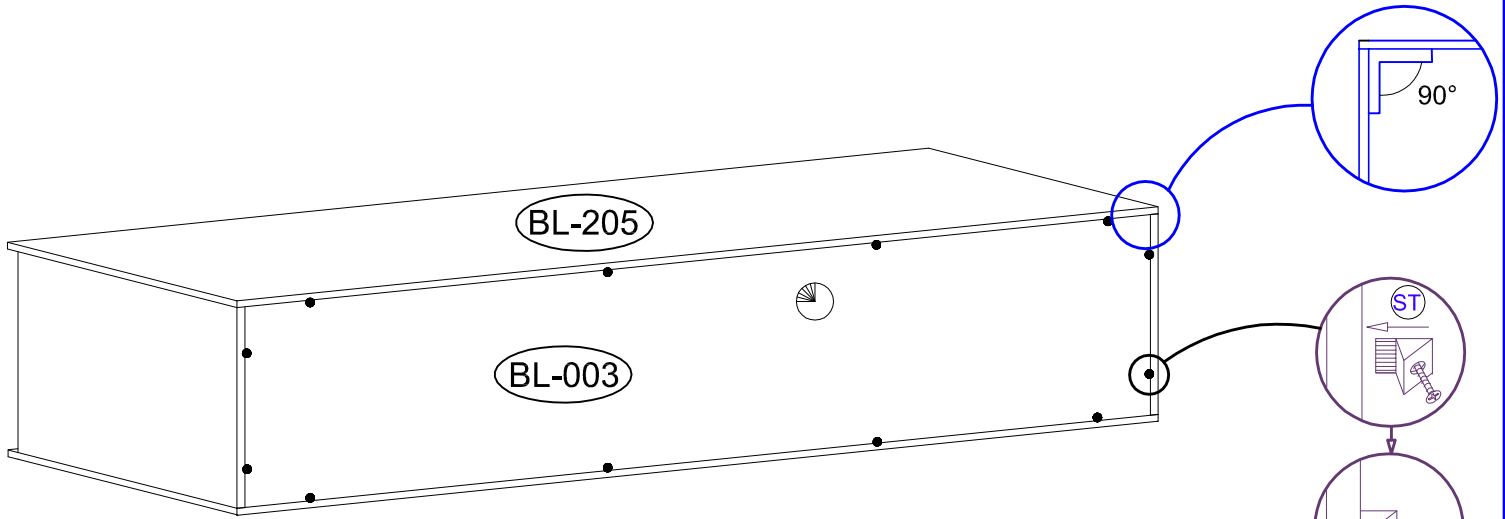

- PUNKTY MOCOWANIA ZACZEPÓW ŚCIAN TYLNYCH
- BEFESTIGUNGSPUNKTE DER RUCKWANDHALTER INNEN
- LES POINTS PRISE (CROCHET) DE TAILLE DERRIERE

# 11



B2x2



B1x2



Lx12



X x2

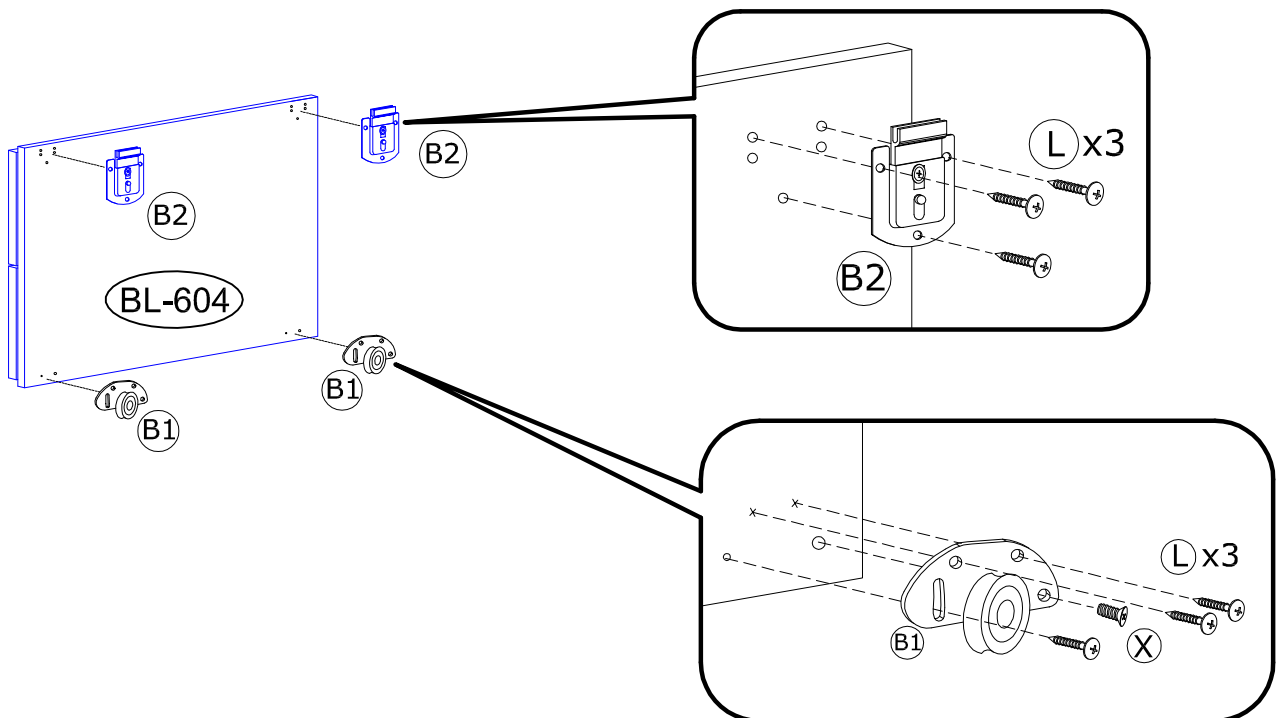

# 12

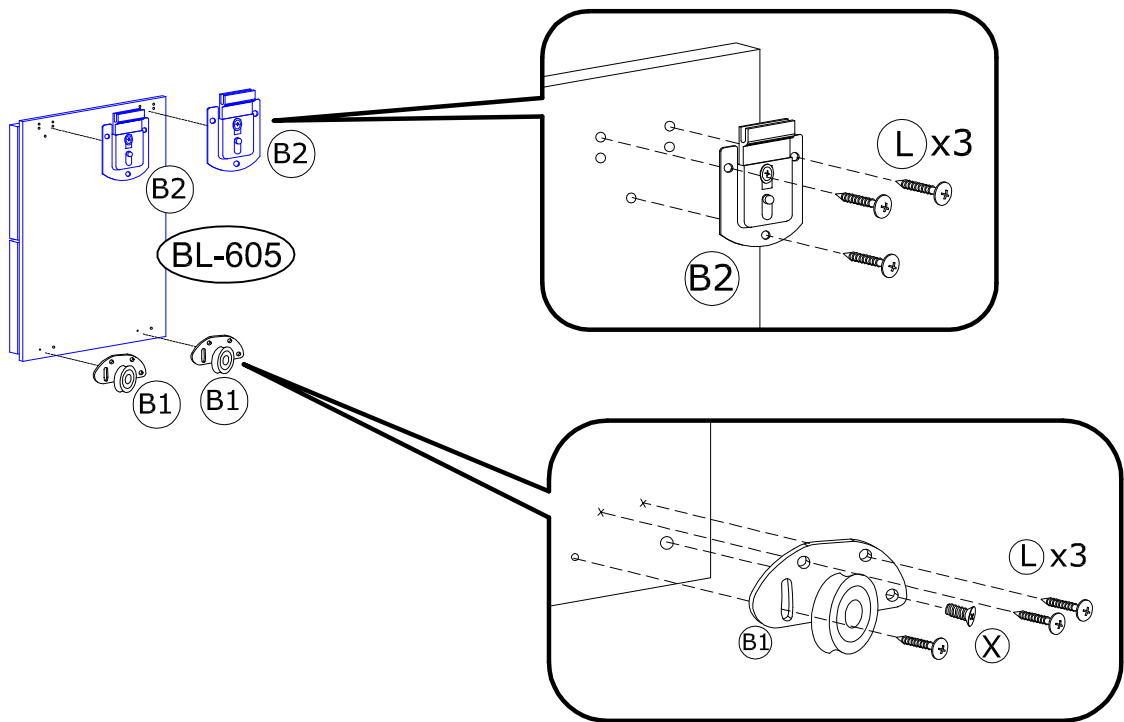
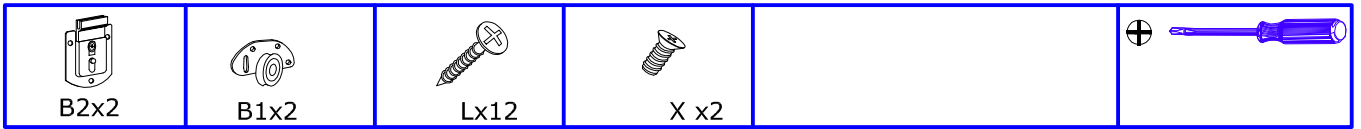

# 13

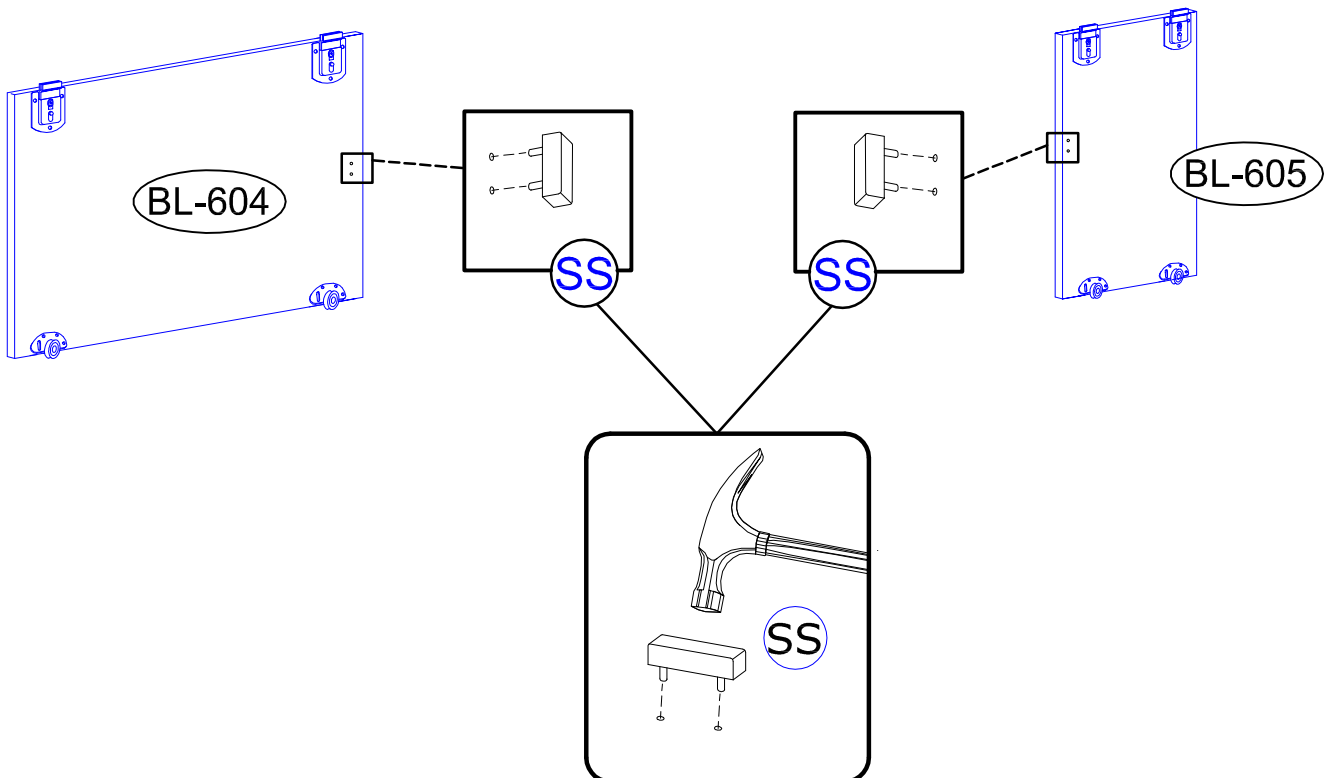

# 14

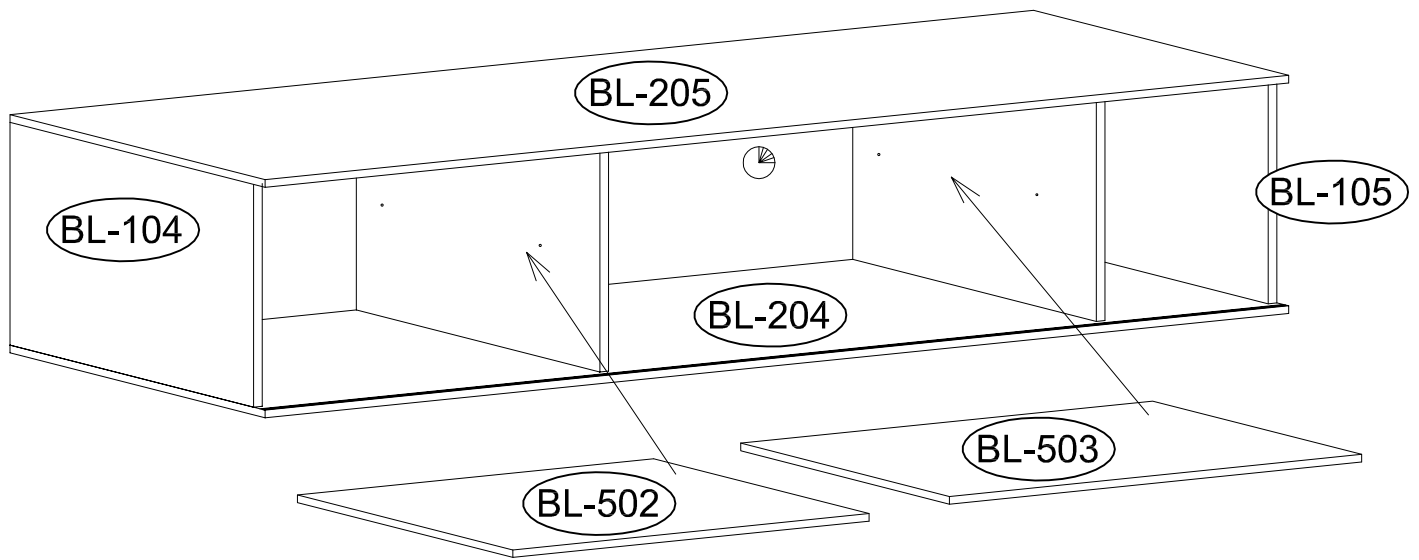

# 15

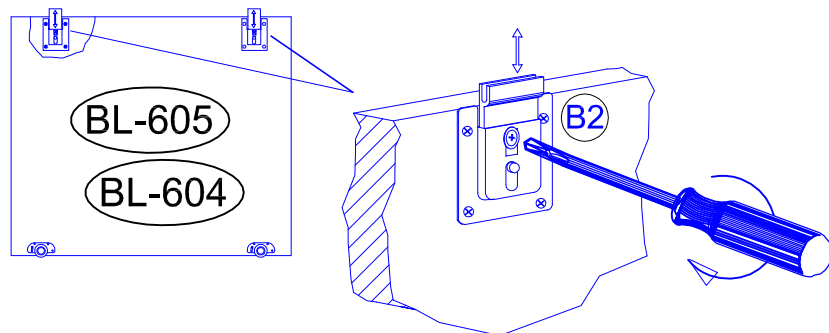
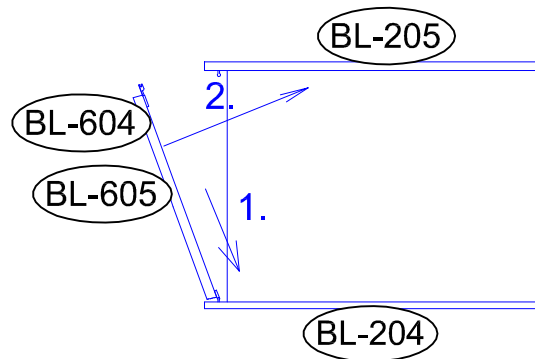

Adjustment screw  
Wkręt regulacyjny