

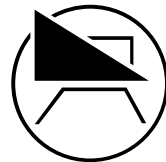

INES PÓŁKA

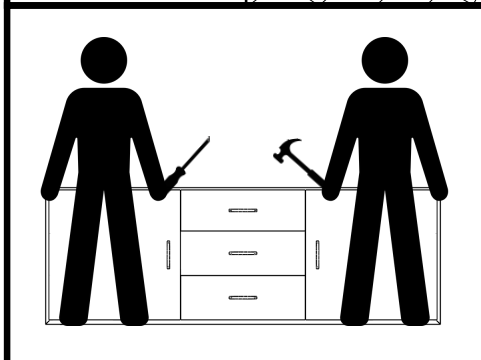

INSTRUKCJA MONTAŻU • ASSEMBLY INSTRUCTION • MONTAGEANLEITUNG

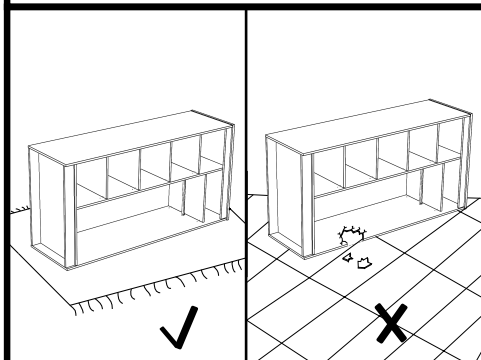
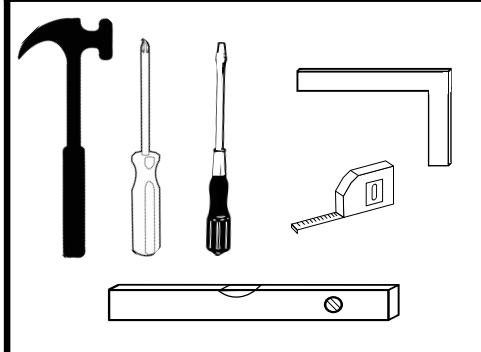
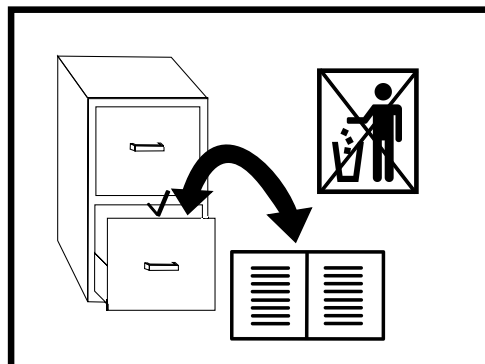
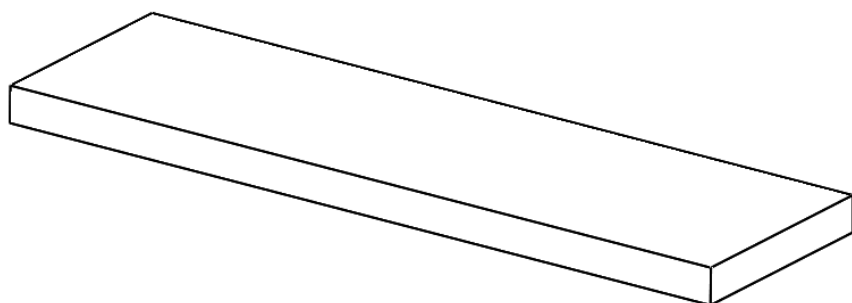

IN-06-C

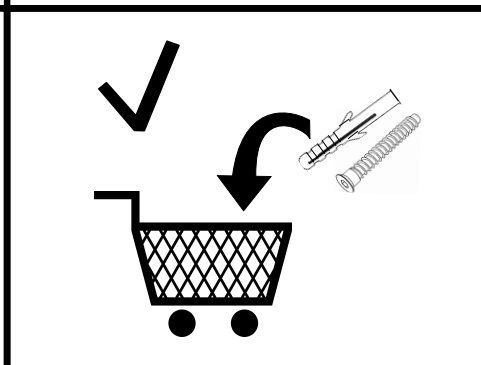
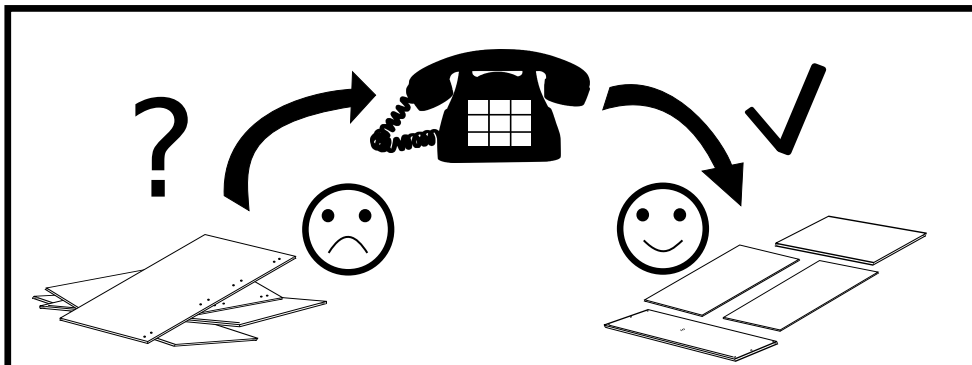

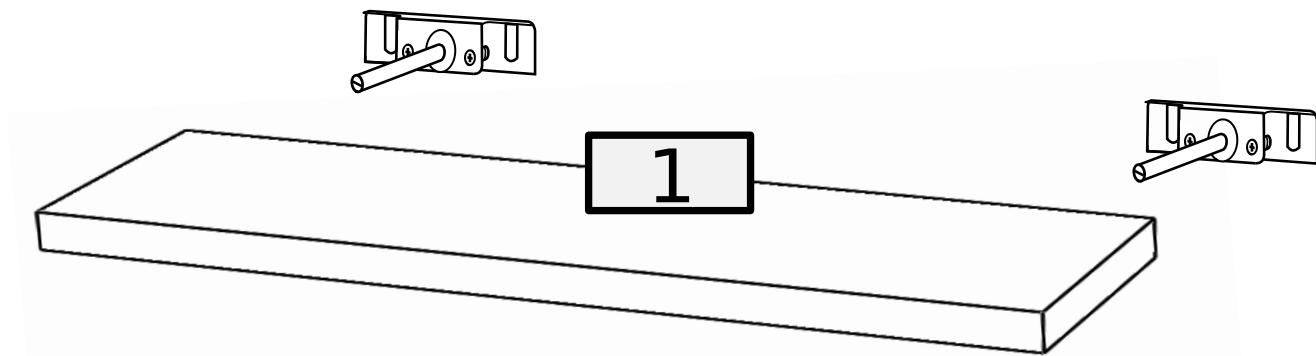

| No. | Pcs. | L | W | D | Pac |
|-----|------|-----|-----|----|-----|
| 1 | 1 | 680 | 200 | 32 | 1/1 |

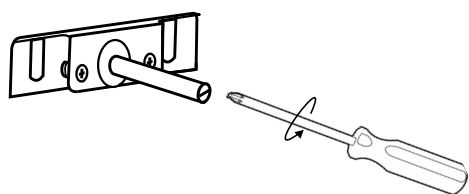
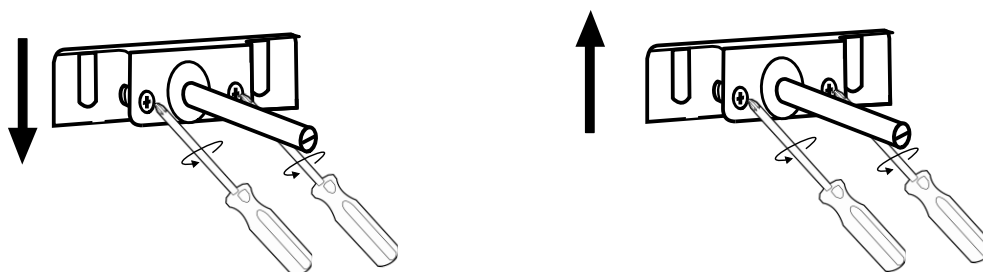
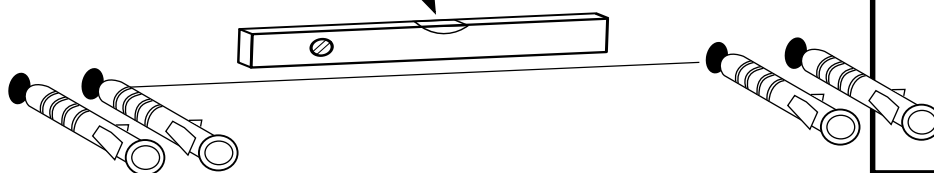
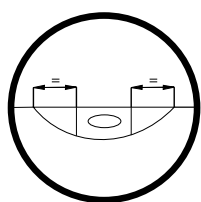
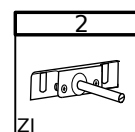

1

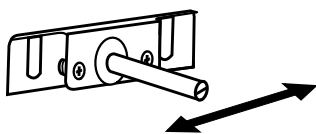

2

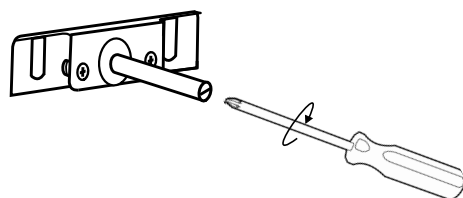

3

