

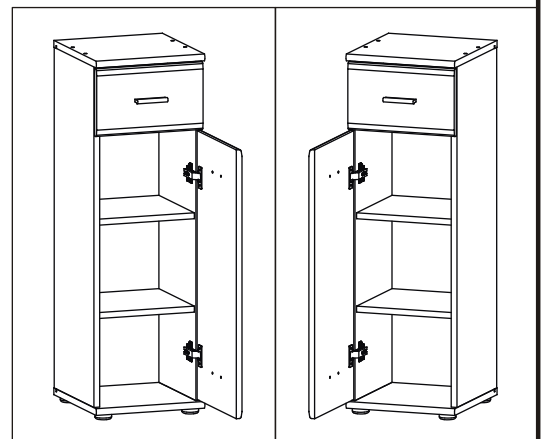

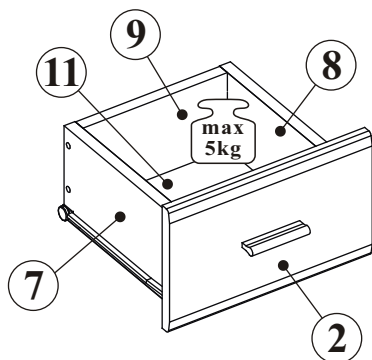

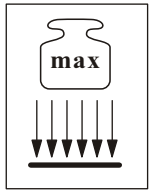

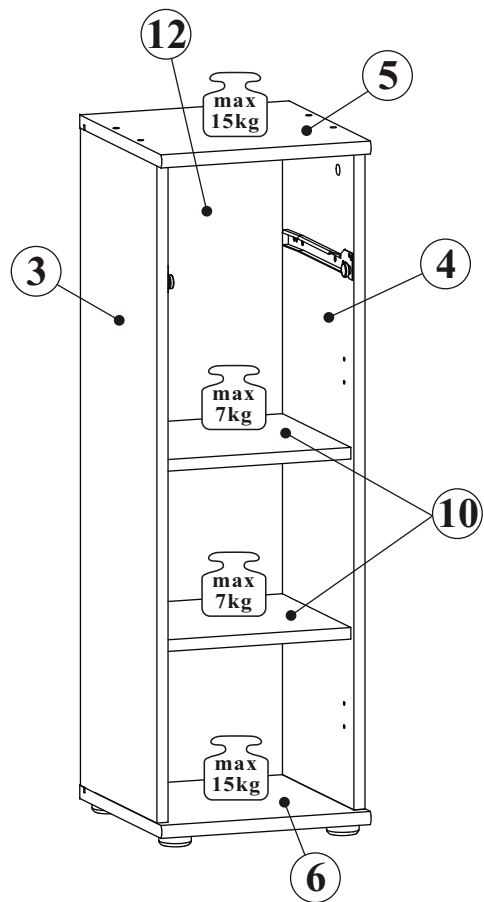

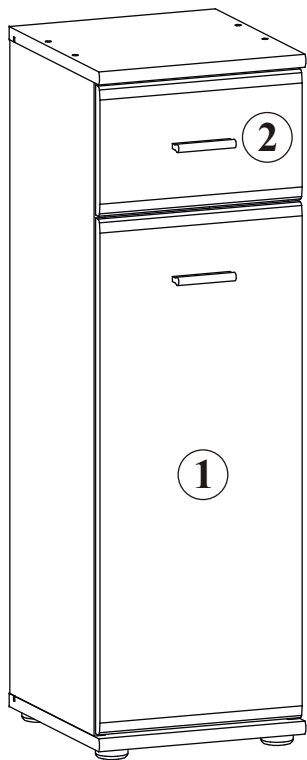
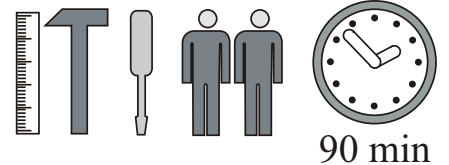

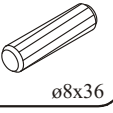
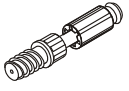

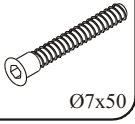

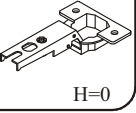
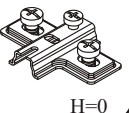
# ARMARIO 1 ECO TYP B

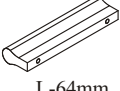

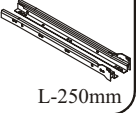
NO	Dim.			Col.-No	Qty
1	714	296	16	1	1
2	296	180	16	1	1
3	905	300	16	1	1
4	905	300	16	1	1
5	302	322	18	1	1
6	302	322	18	1	1
7	250	132	16	1	1
8	250	132	16	1	1
9	211	112	16	1	1
10	268	268	16	1	2
11	223	253	3	1	1
12	916	279	3	1	1

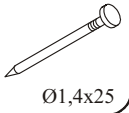
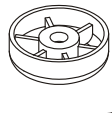

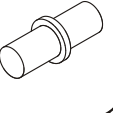
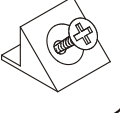

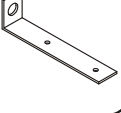
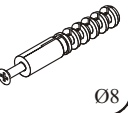

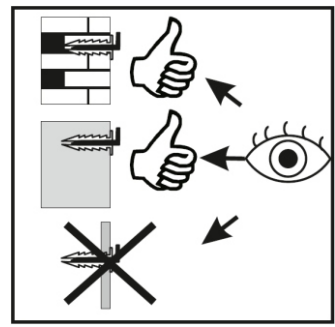
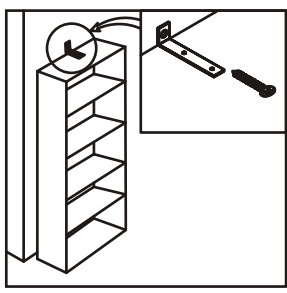
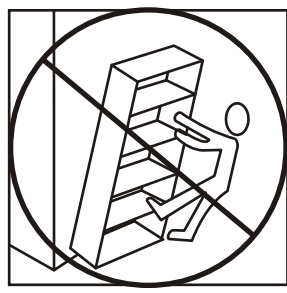
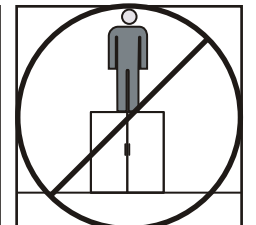
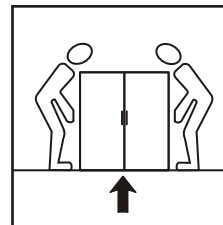
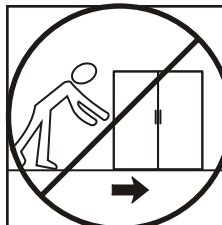
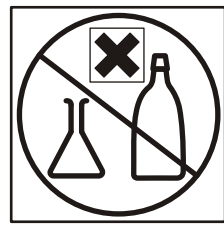
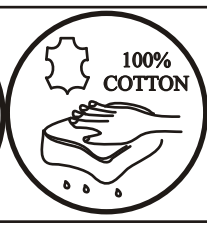
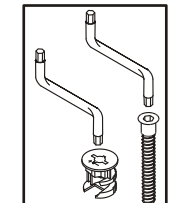
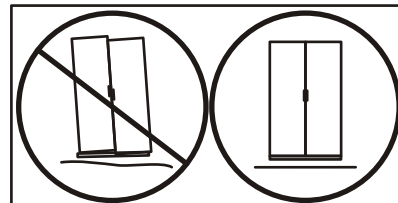
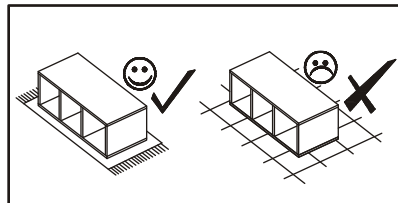
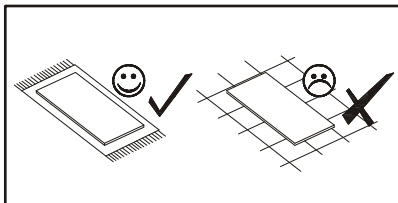
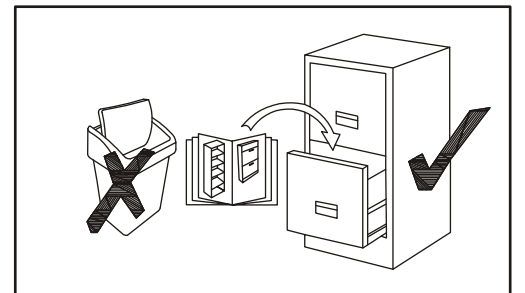
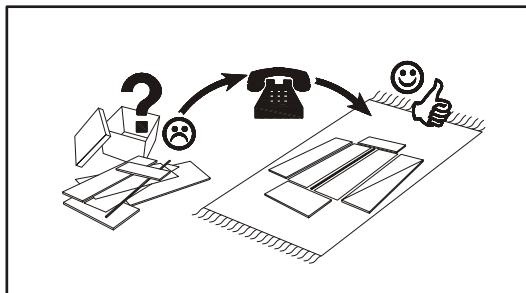
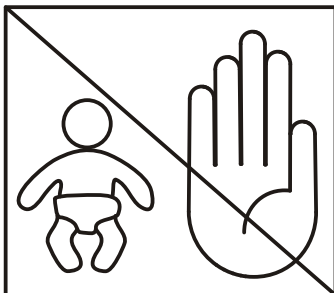
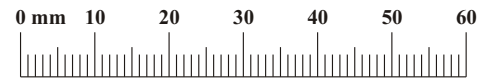
# ARMARIO 1 ECO TYP B

A1 x12  ø8x36	B4 x6 	B5 x6  ø15x12	G5 x6 	B11 x8  ø7x50	G4 x8 
E1 x2  H=0 Ø26	E2 x2  H=0	D10 x10  USØ3,5x13	KL x2  L-64mm	UP6 x4  UPØ4x30	Z2 x2  Ø5
H5 x1  L-250mm	D8 x4  ESØ5x13	B3 x5  Ø1,4x25	I11 x4 	UP11 x4  UPØ4x20	G7 x8 
S1 x9 	G2 x1 	L1 x1 	KR1 x1  Ø8		

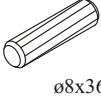

ARMARIO 1 ECO TYP B

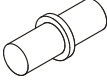
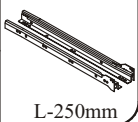
1

A1	 ø8x36	B5	 ø15x12	G7	
x8		x4		x8	
H5	 L-250mm	D8	 ESØ5x13		
x1		x4			

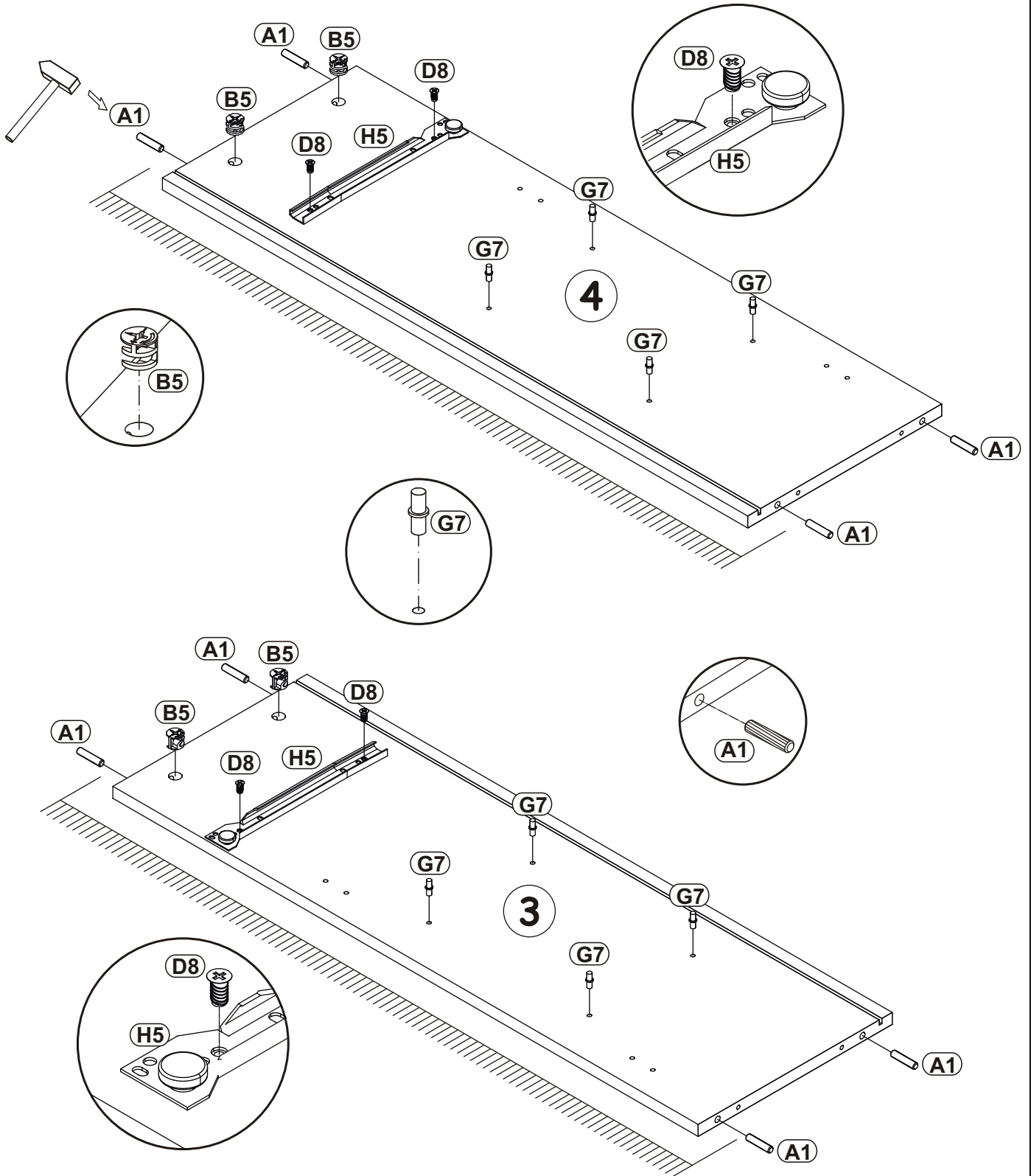

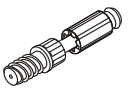

2

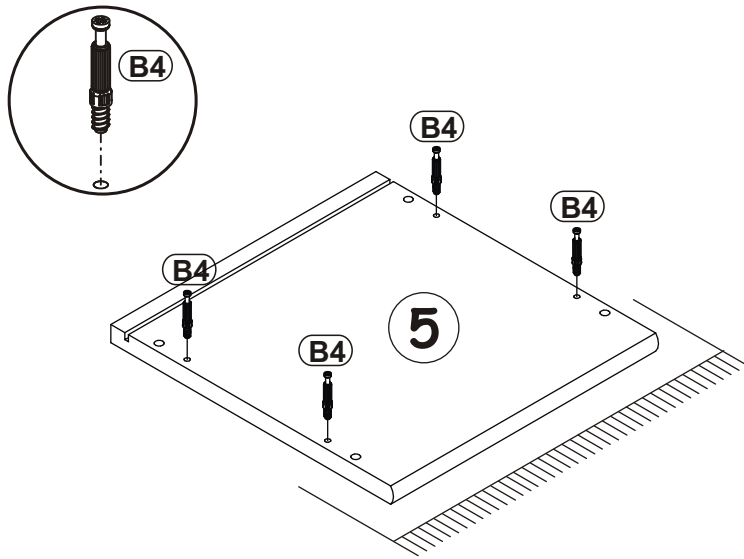
B4	
x4	

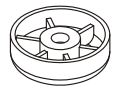

3

I11	
x4	

UP11	
x4	

UPØ4x20

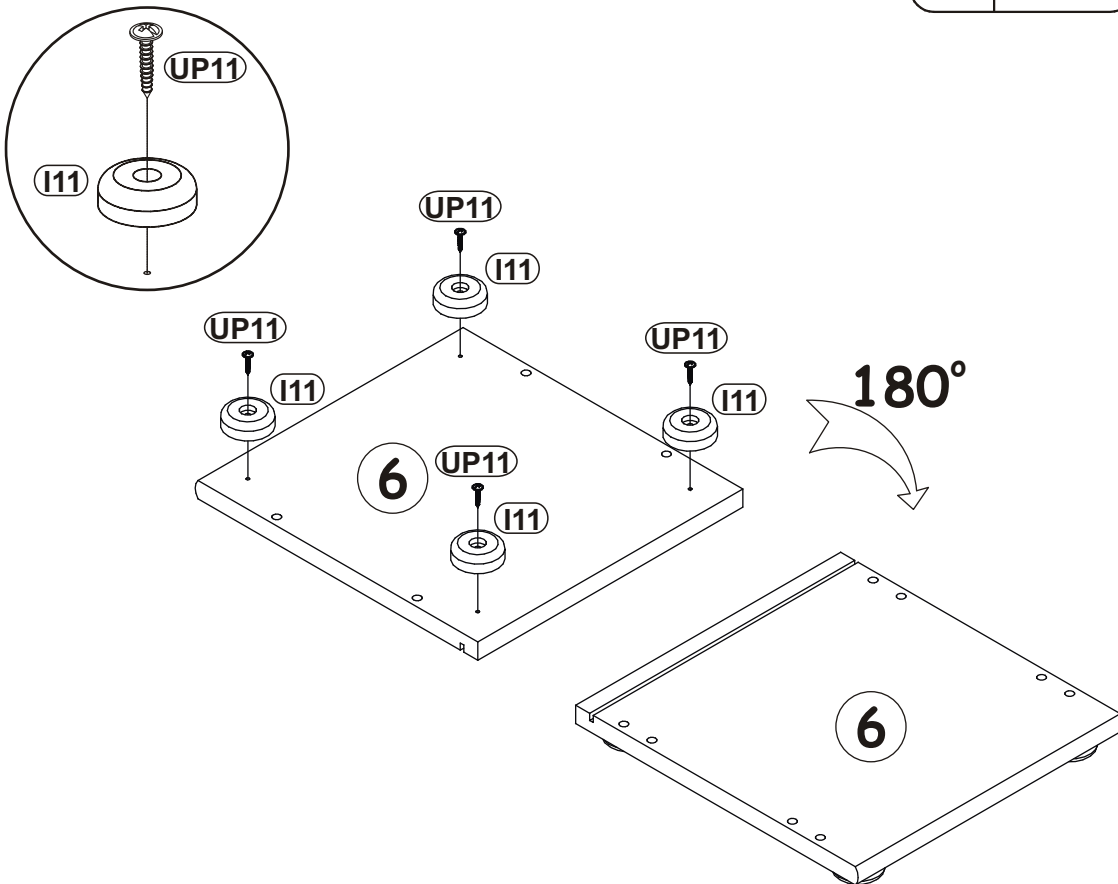

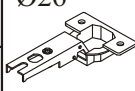
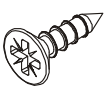

4

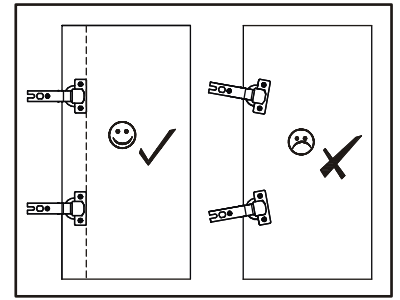
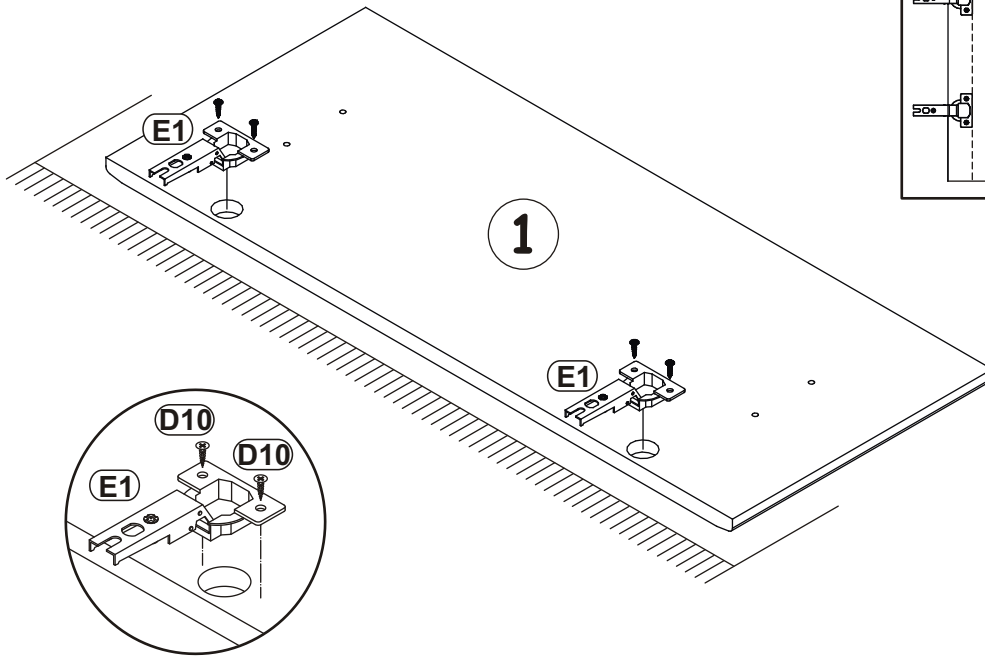
E1	Ø26 	D10	
x2	H=0	x4	USØ3,5x13



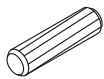
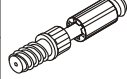

5

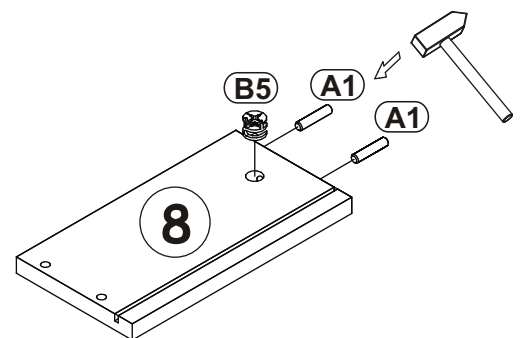
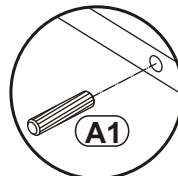
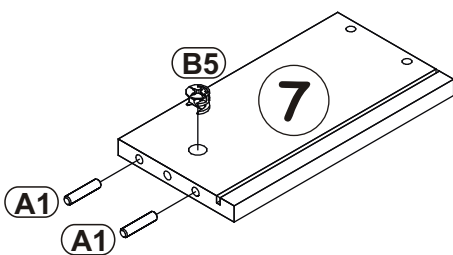
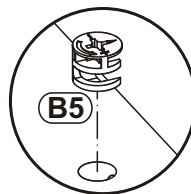
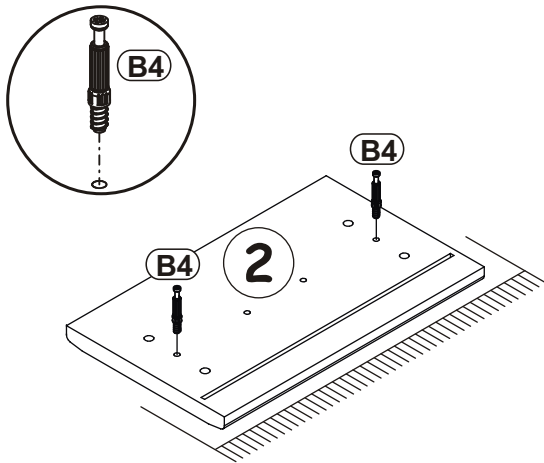
A1		B4		B5	
x4	ø8x36	x2		x2	ø15x12



6

B11		G4	
x4	Ø7x50	x4	

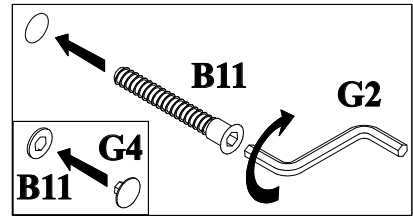
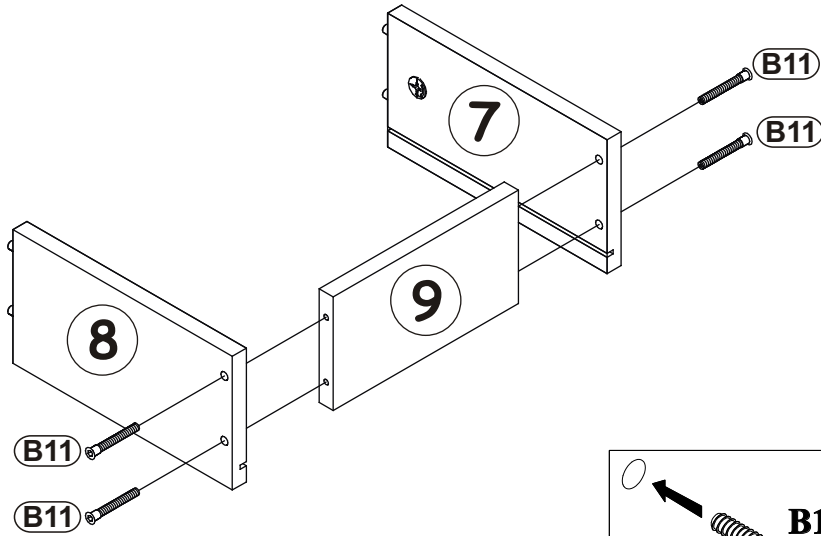

7

G5	
x2	

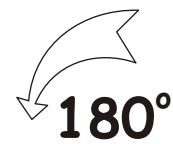
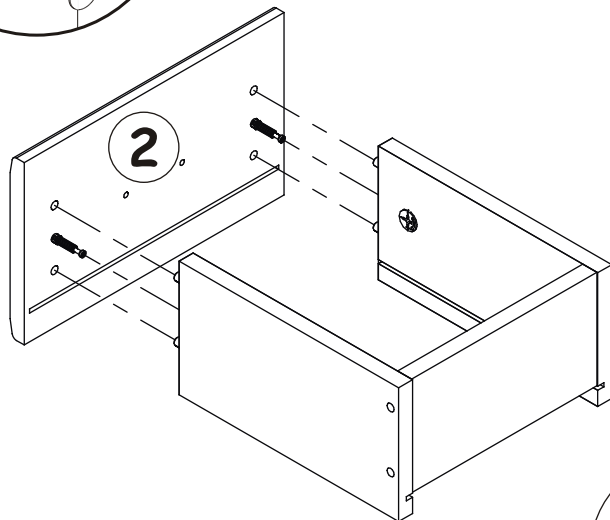
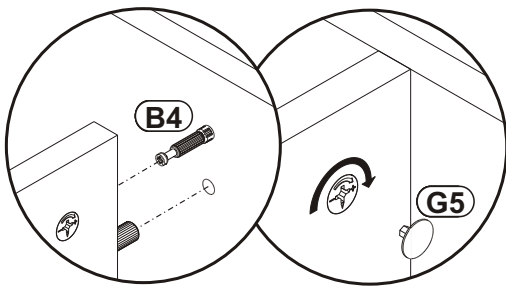

8

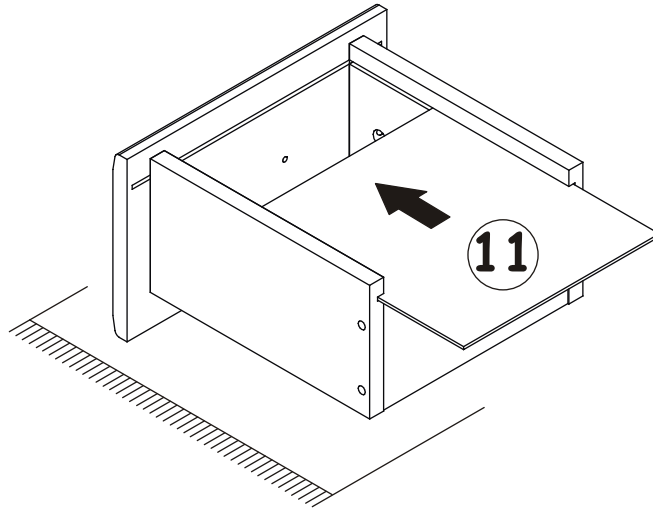

9

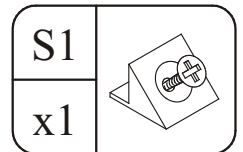
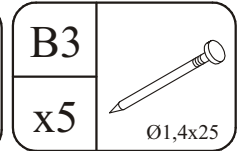
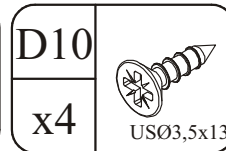
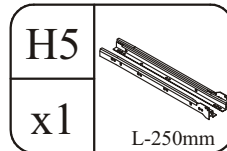
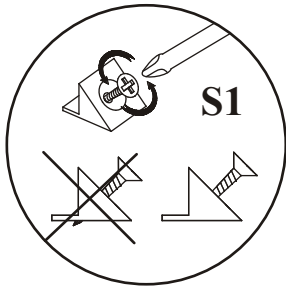

X=Y  $90^\circ$

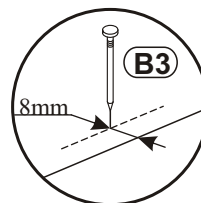
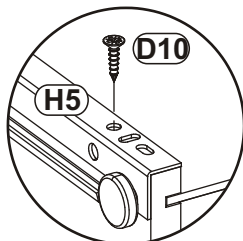
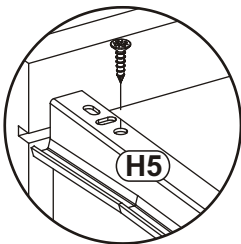
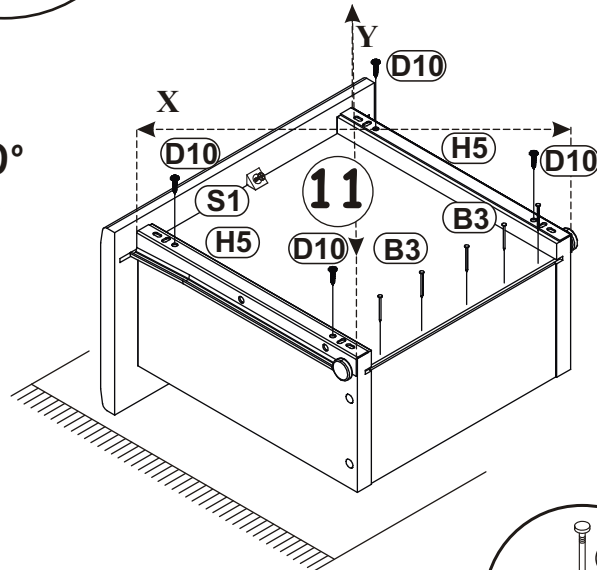

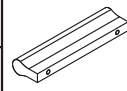
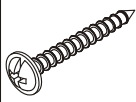

$180^\circ$

10

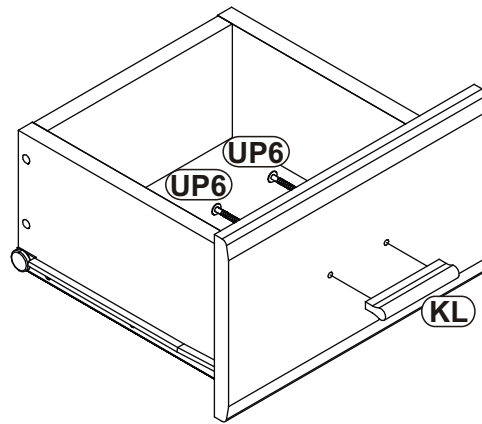
KL		UP6	
x1	L-64mm	x2	UPØ4x30



11

B11		G4	
x4	Ø7x50	x4	

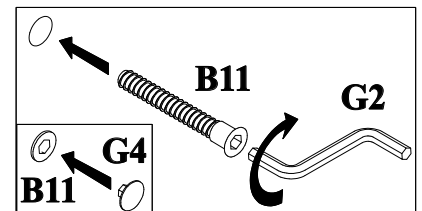
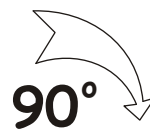
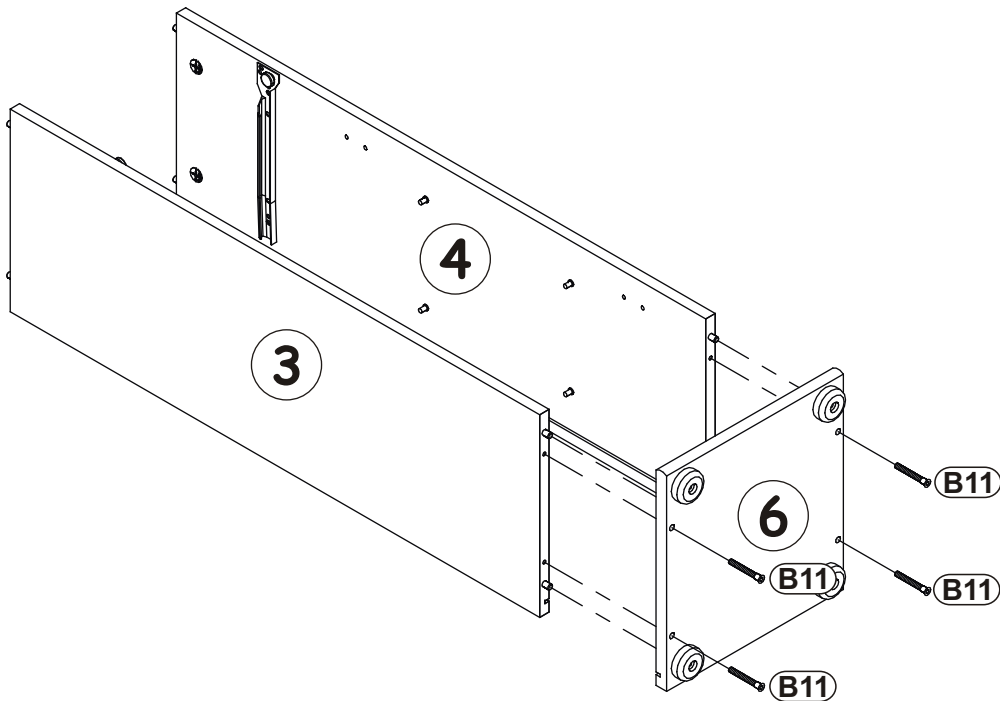



12

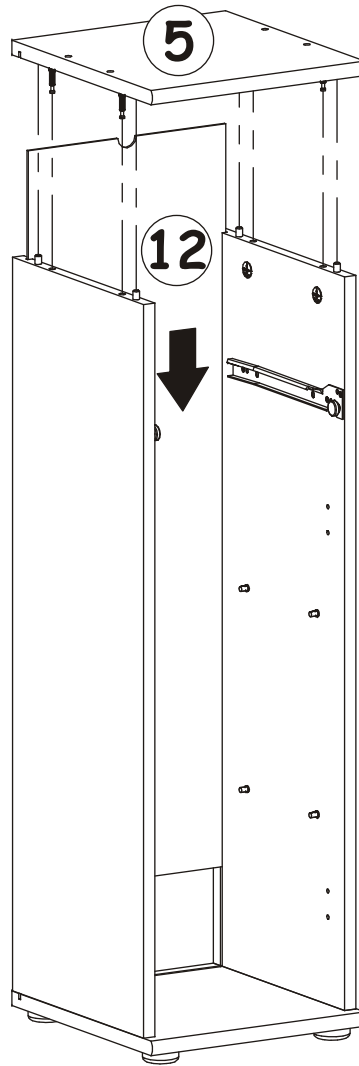

G5	
x4	

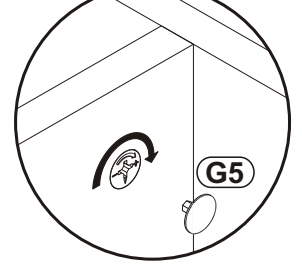
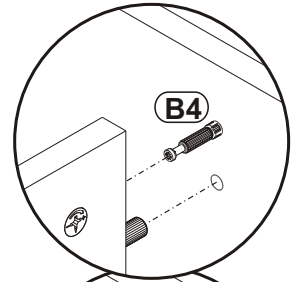

13

$X=Y$   $\uparrow$  90°

S1	
x8	

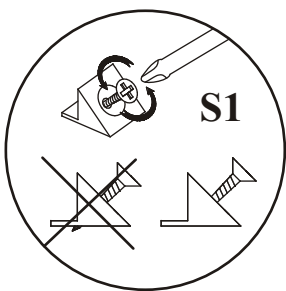
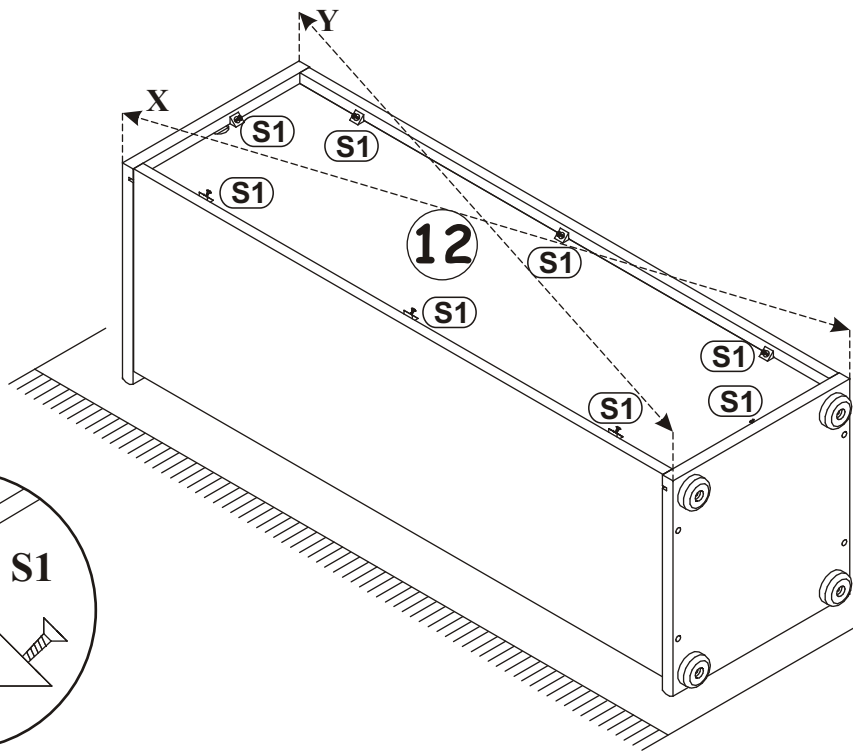

14

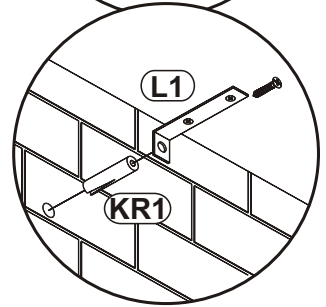
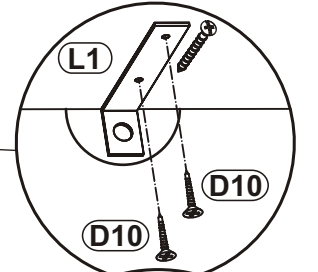
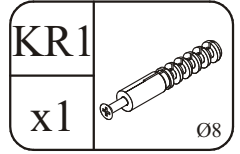
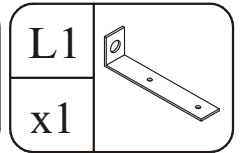
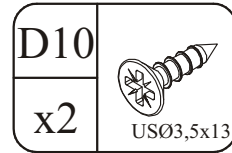
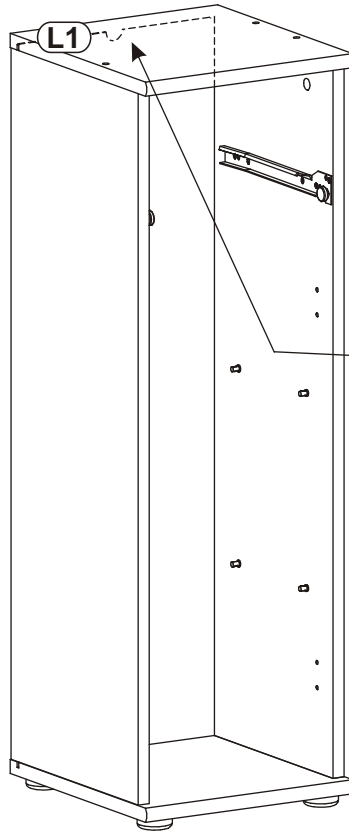
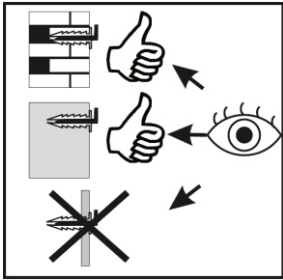
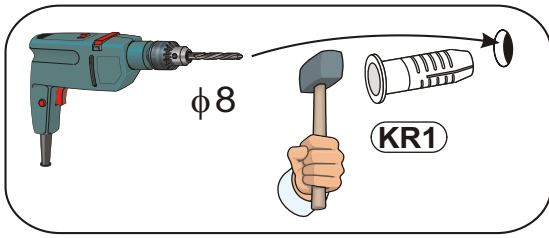

15

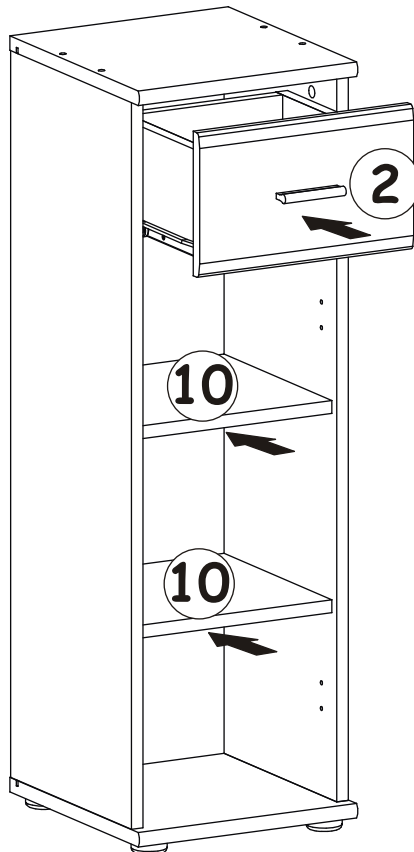
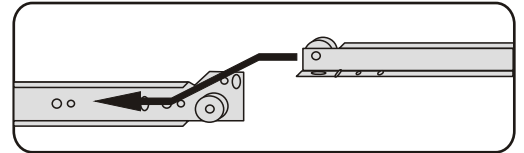

**16-19**

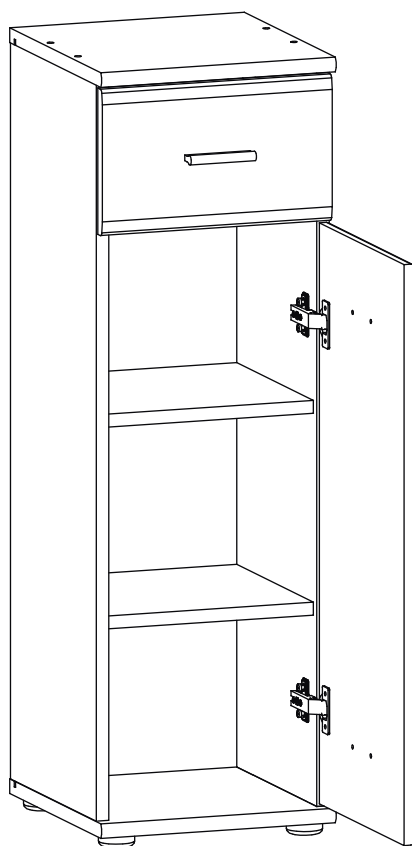

**20-23**

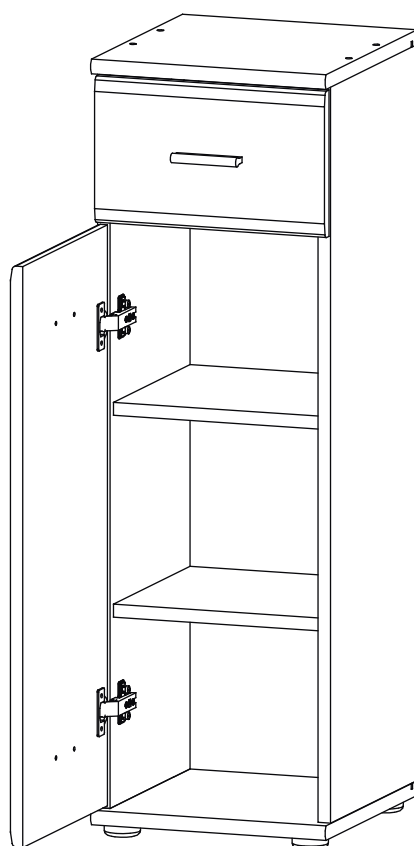

16

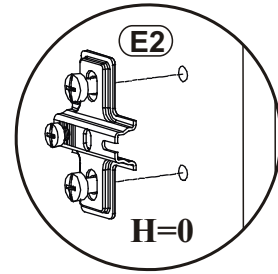
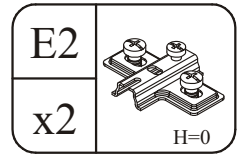
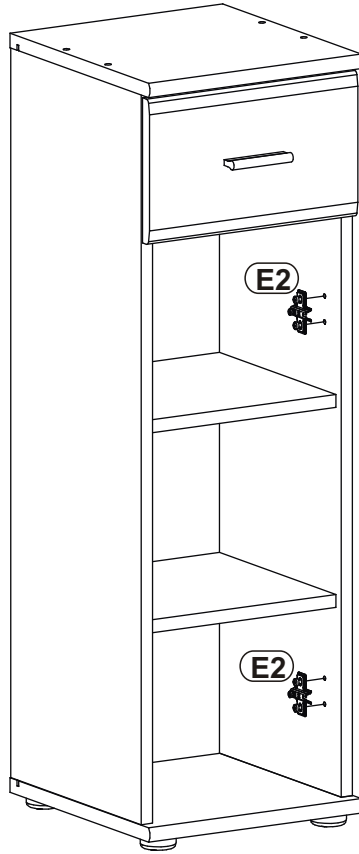
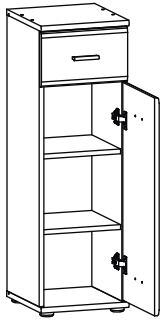

17

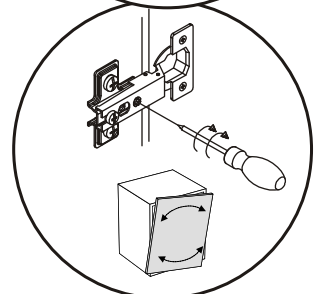
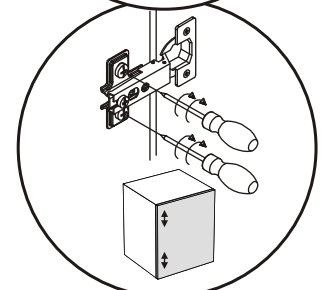
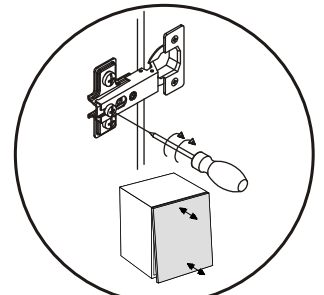
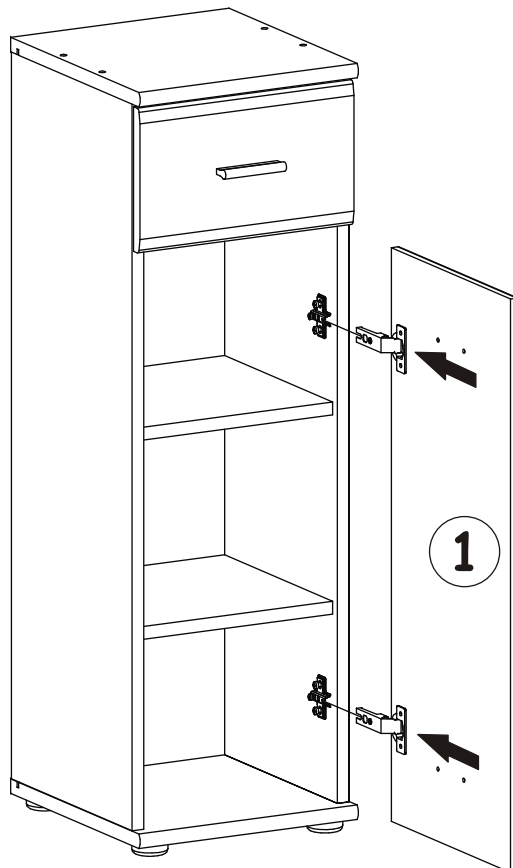

18

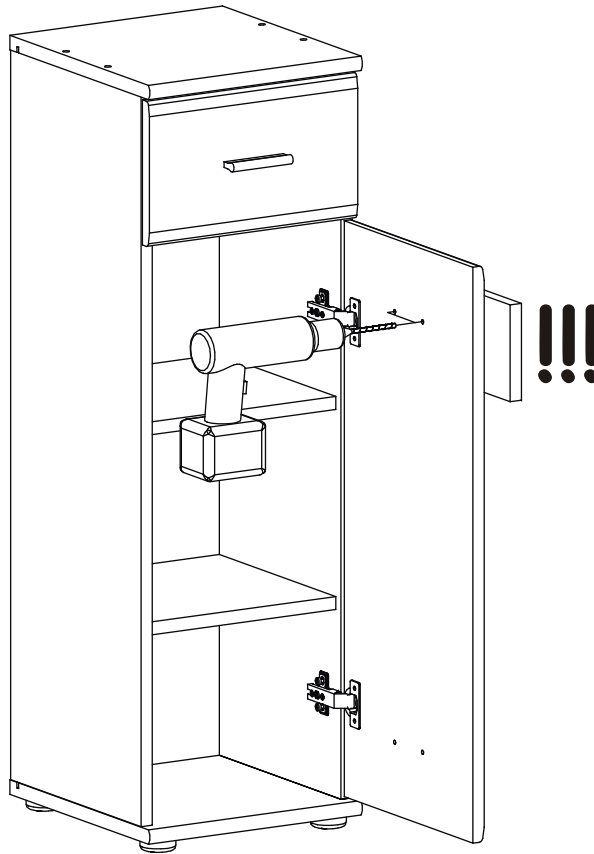
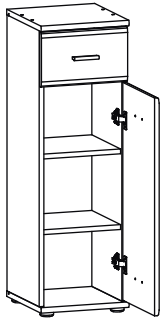

φ5

19

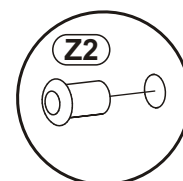
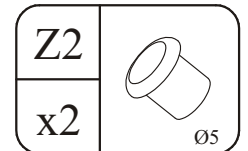
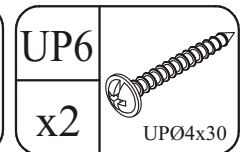
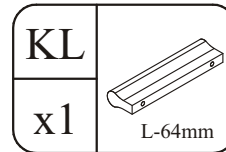
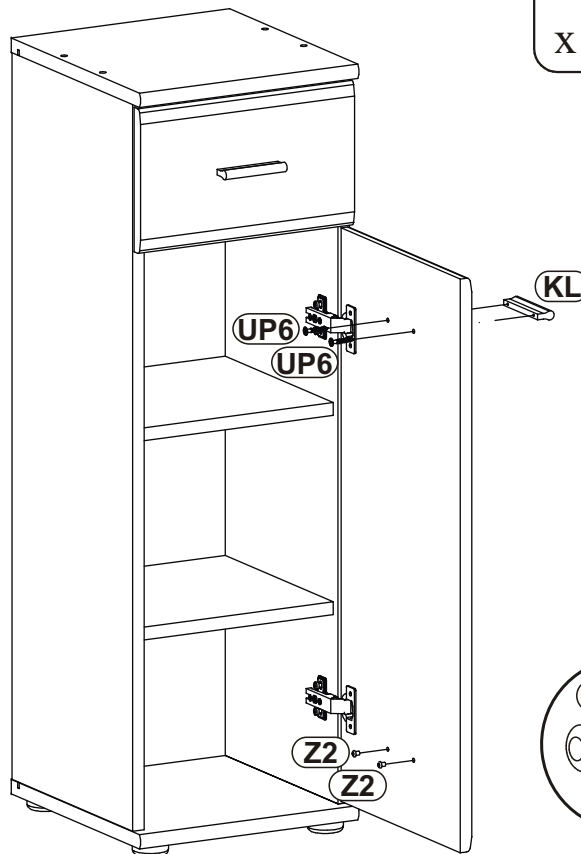

20

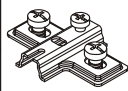
E2	
x2	H=0

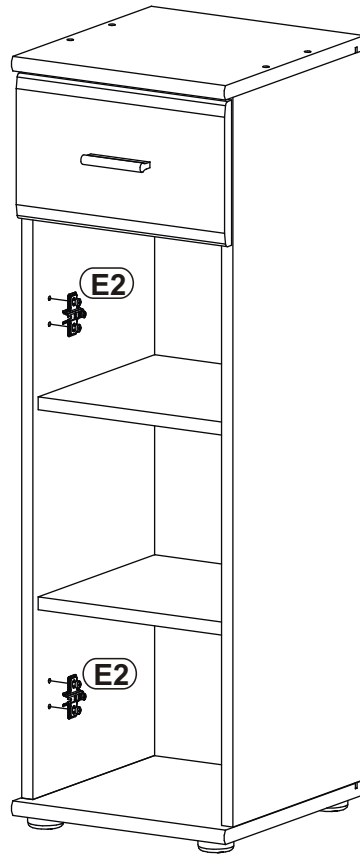
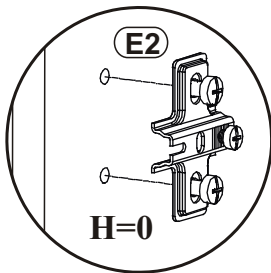
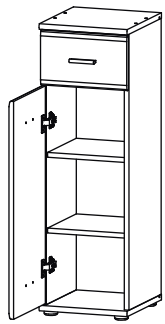

21

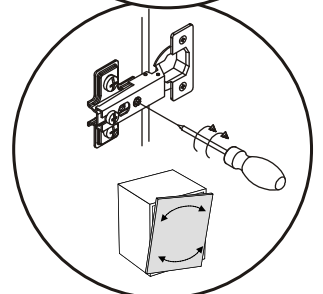
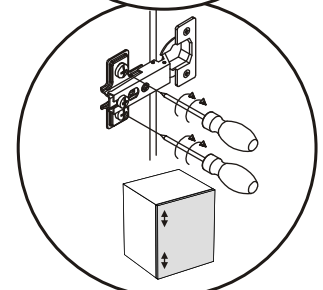
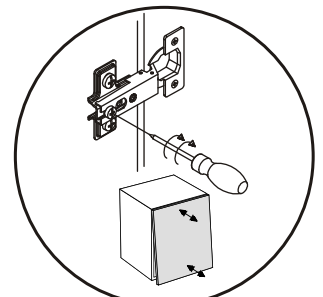
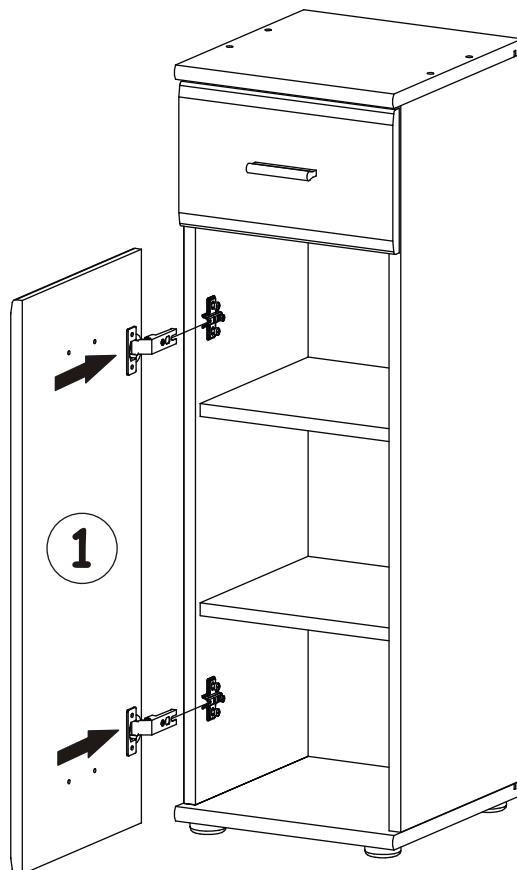

ARMARIO 1 ECO TYP B

22

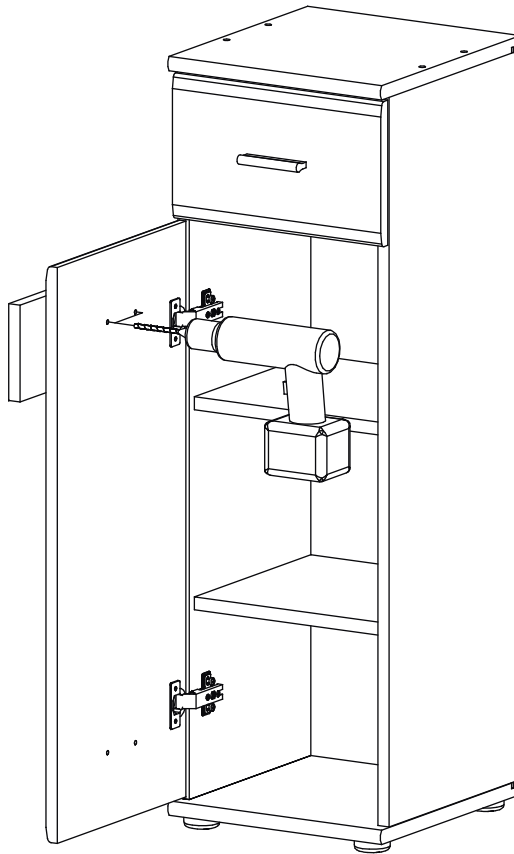
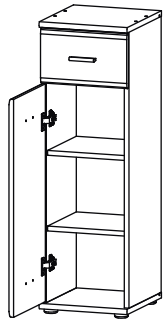

23

