

### LED Option

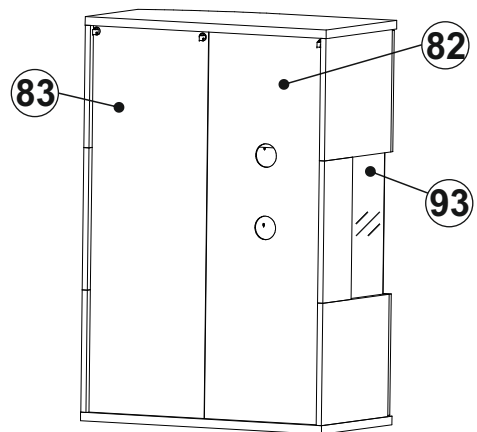

### LED Option

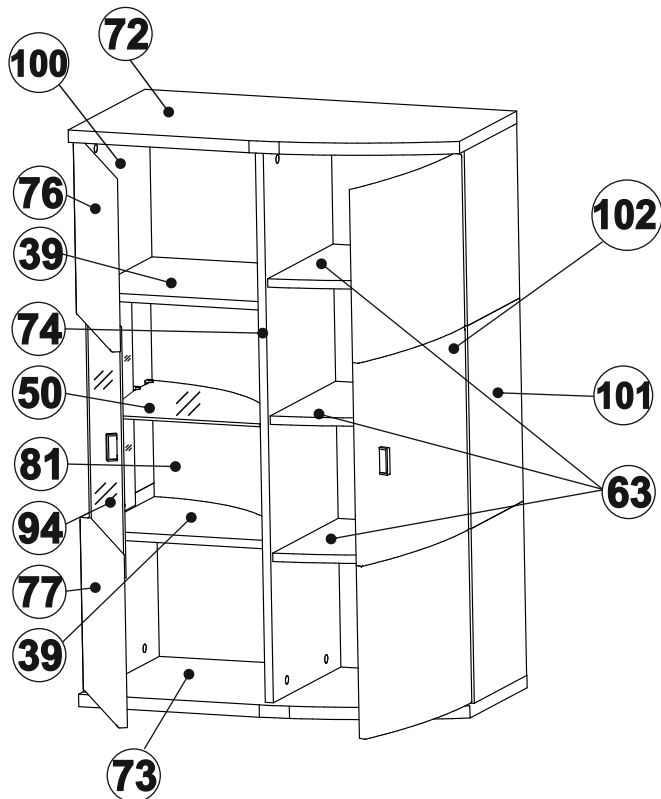
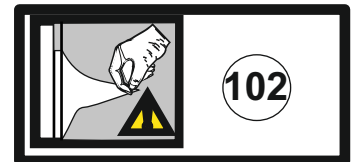

# DERA 051

# A4DAQT051

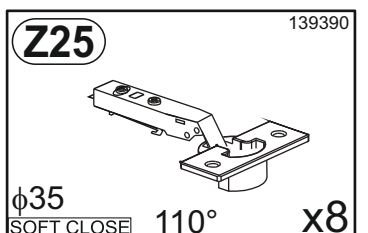
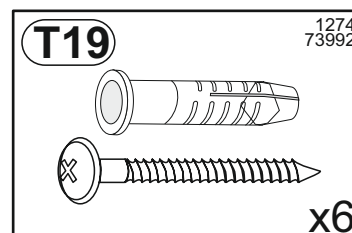
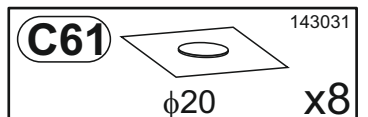
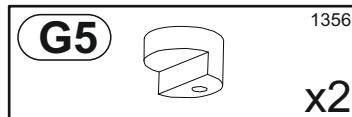
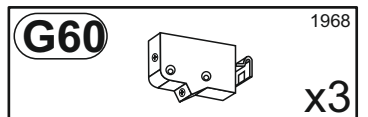
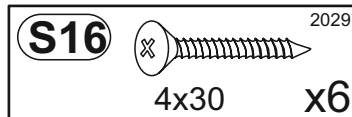
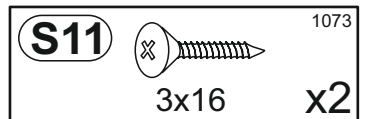
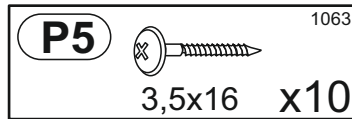
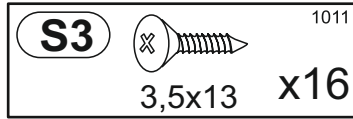
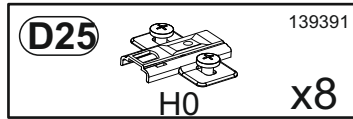
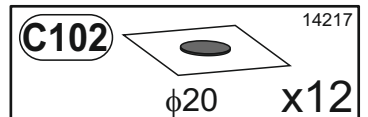
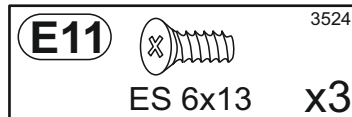
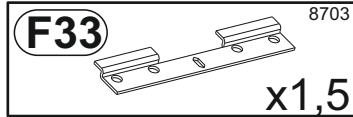
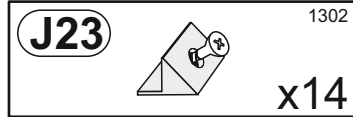
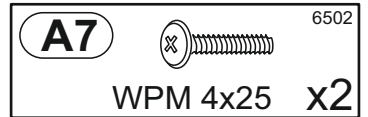
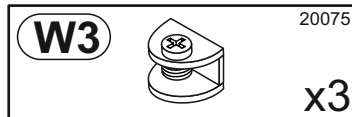
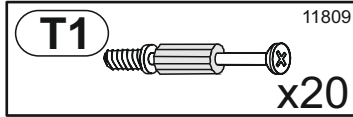
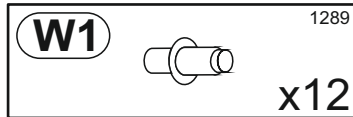
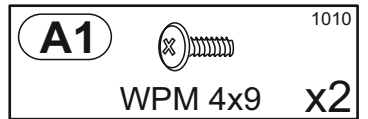
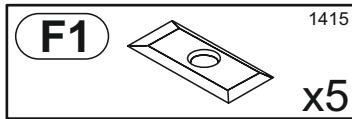
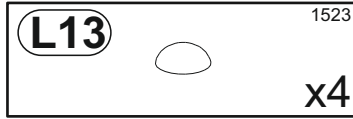
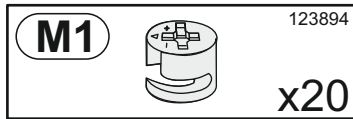
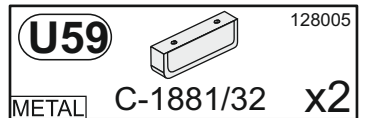
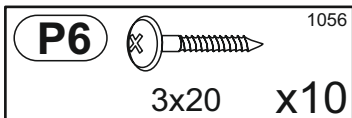
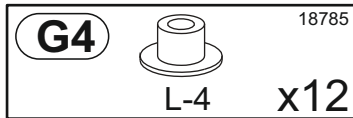
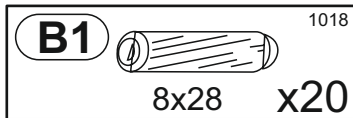

AI NR	QTY	H	W	D	PKG
39	x2	327	320	15	2/2
50	x1	320	310	5	1/2
63	x3	324	320	15	1/2
72	x1	701	374	22	1/2
73	x1	701	374	22	1/2
74	x1	990	330	15	2/2
76	x1	346	310	18	2/2
77	x1	346	310	18	2/2
81	x1	464	412	2,5	1/2
82	x1	1002	339	2,5	1/2
83	x1	1002	339	2,5	1/2
93	x1	404	214	4	1/2
94	x1	450	323	4	1/2
100	x1	352	990	16	2/2
101	x1	256	990	16	2/2
102	x1	359	984	18	2/2

## SERVICE only for German and Austria Market

Sollte trotz aller Qualitätskontrollen der gelieferte Artikel nicht einwandfrei sein, können wir jedes Teil kurzfristig kostenlos zur Verfügung stellen. Benutzen Sie bitte die beigegefügte Service-Karte!

Wir sind immer für Sie da.....

Telefon : 05221-342790

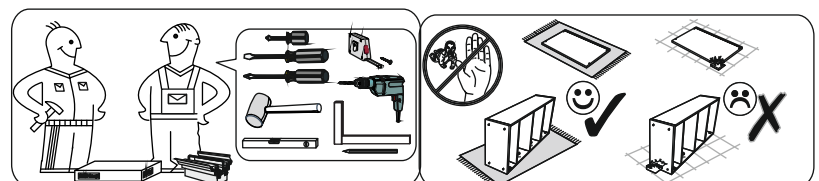
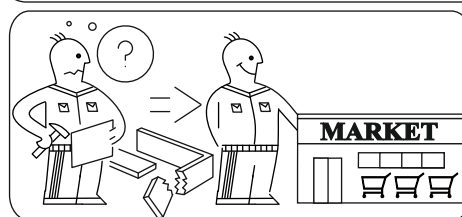

Fax : 05221-342 7929

Mail : kundendienst@forestdream.de

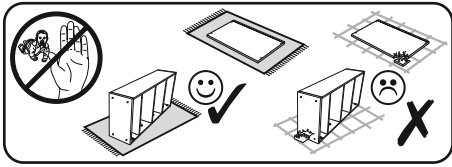

1

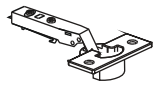



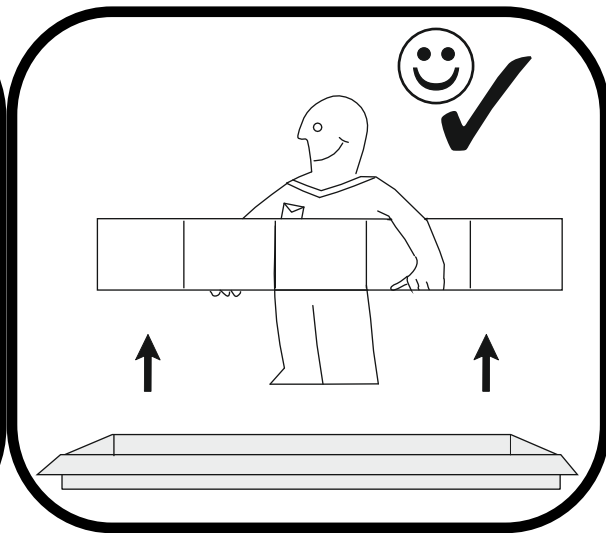
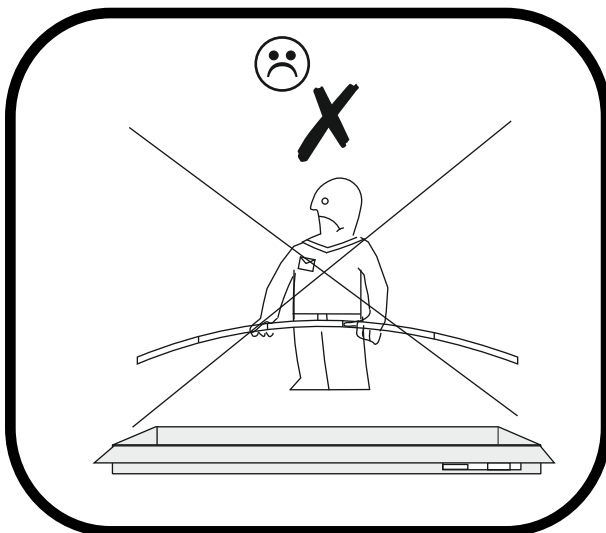
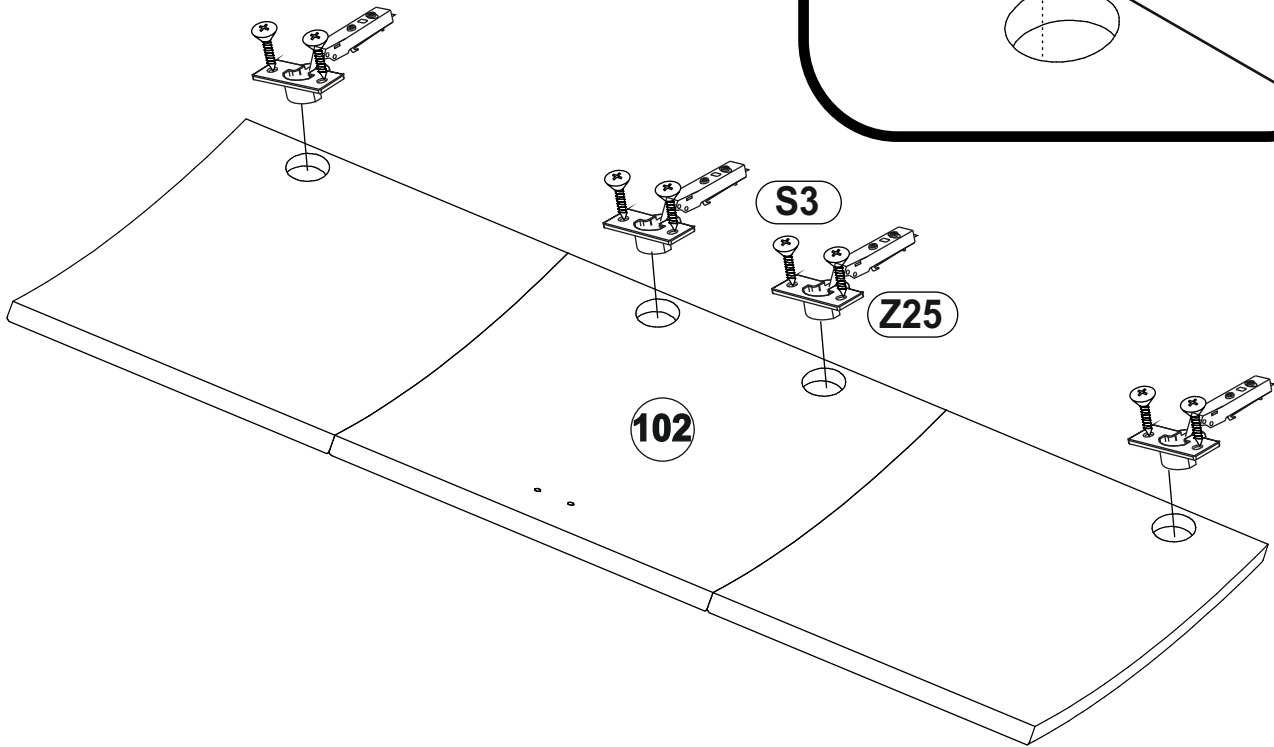
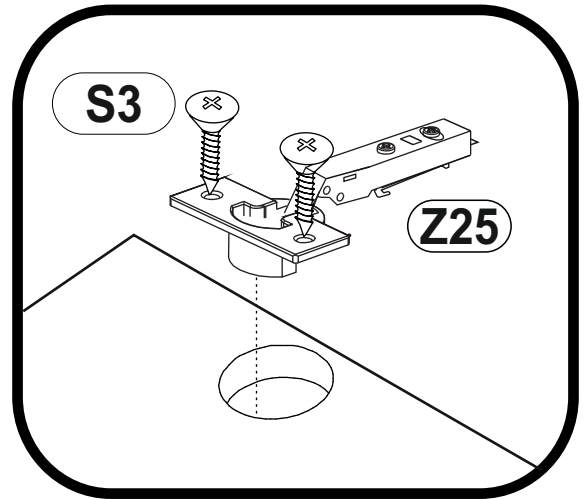
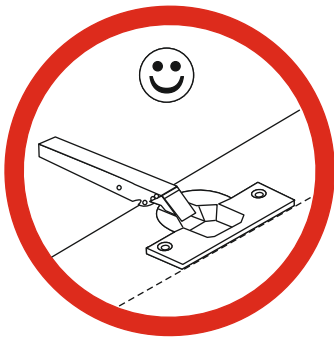

<b>Z25</b>	139390
	
φ35 SOFT CLOSE 110°	x4
<b>S3</b>	1011
	
3,5x13	x8

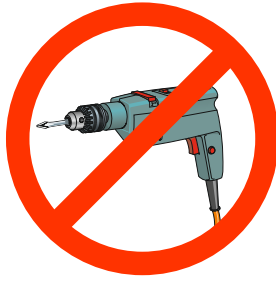
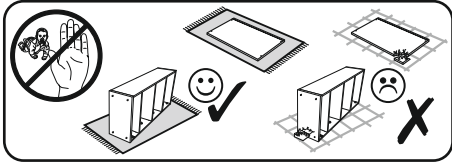

2



- Z25** 139390  
  
 $\phi 35$  SOFT CLOSE 110° x4
- S3** 1011  
  
 3,5x13 x8
- P5** 1063  
  
 3,5x16 x6
- G4** 18785  
  
 L-4 x6

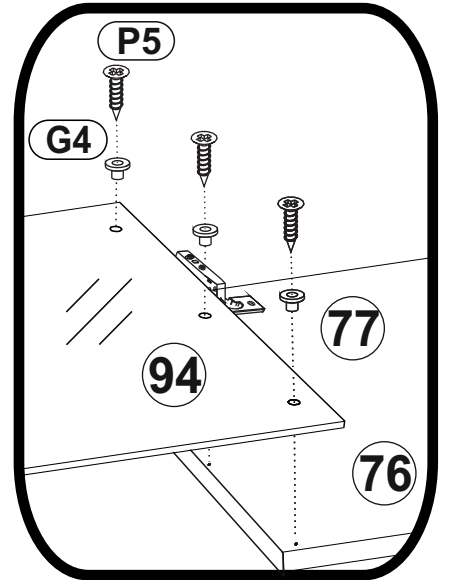
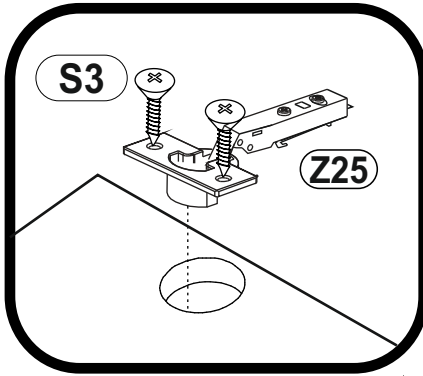
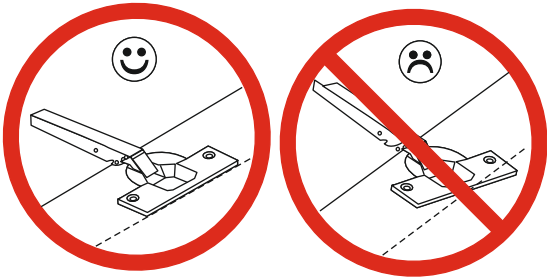
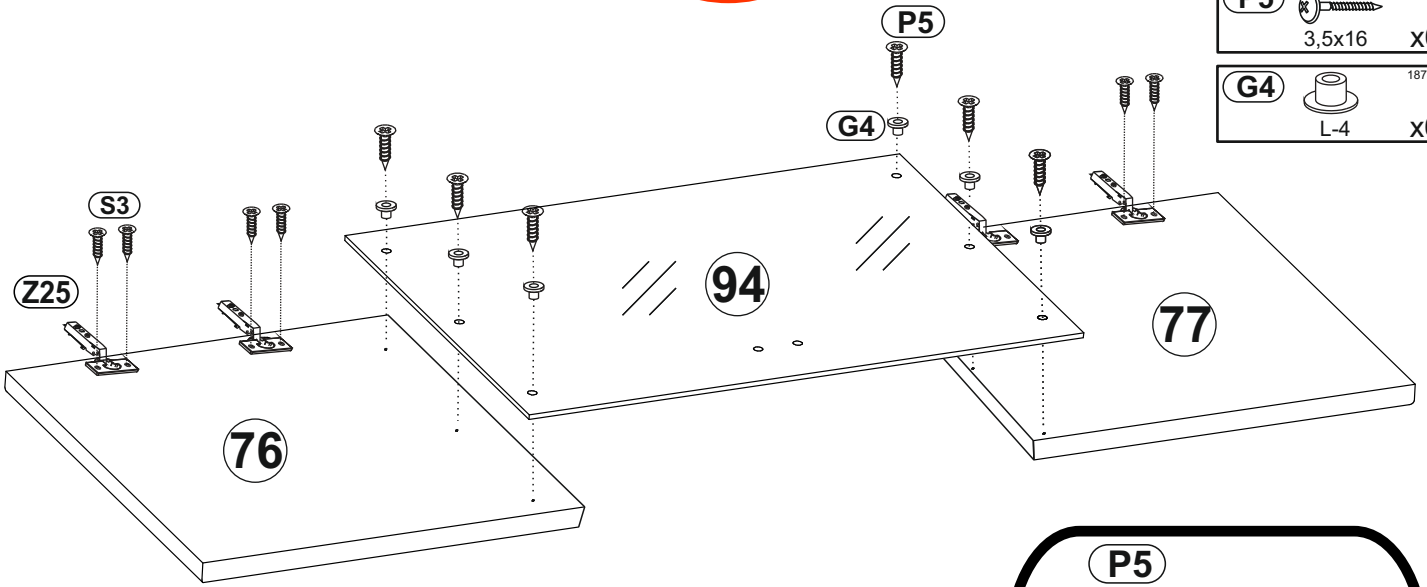

3

- T1** 11809  
  
 x6

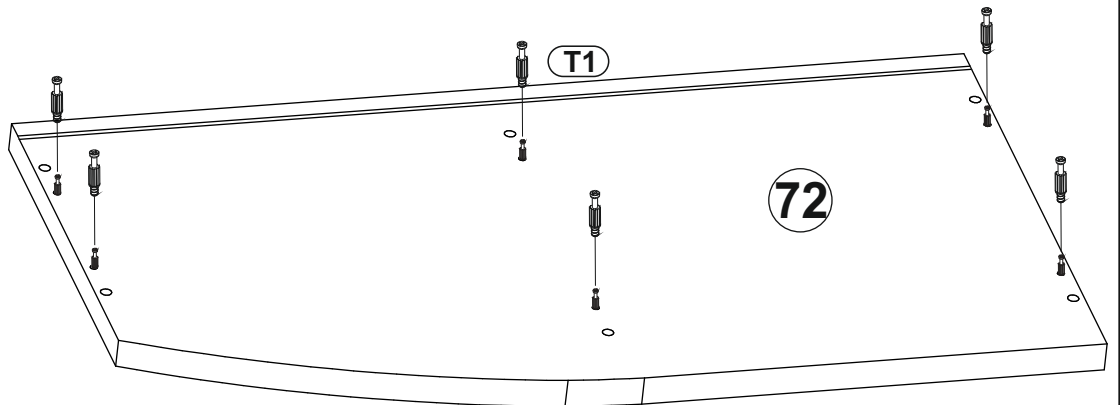
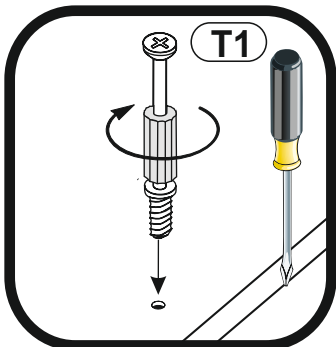

4

T1 11809 x6

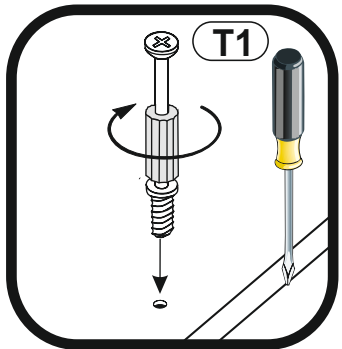
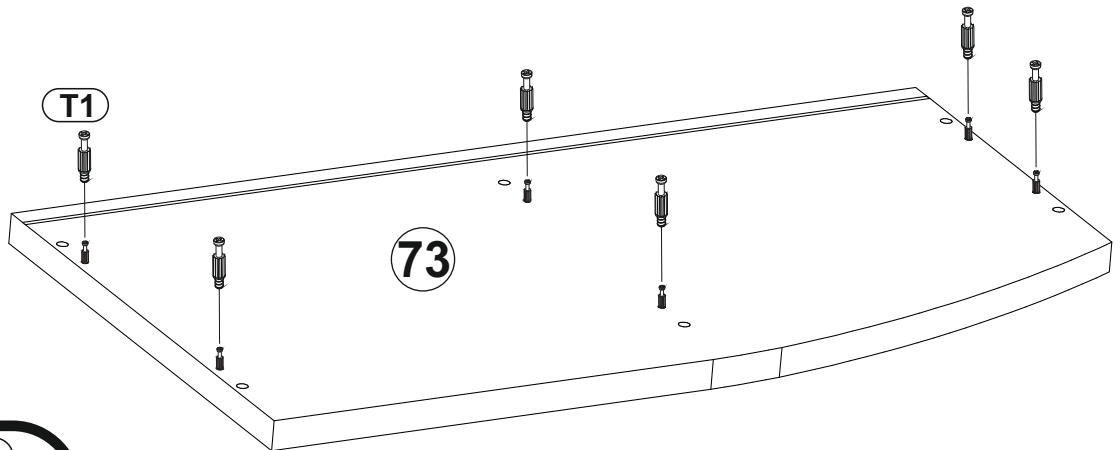

5

B1 1018 8x28 x4  
M1 123894 x4  
D25 139391 H0 x4

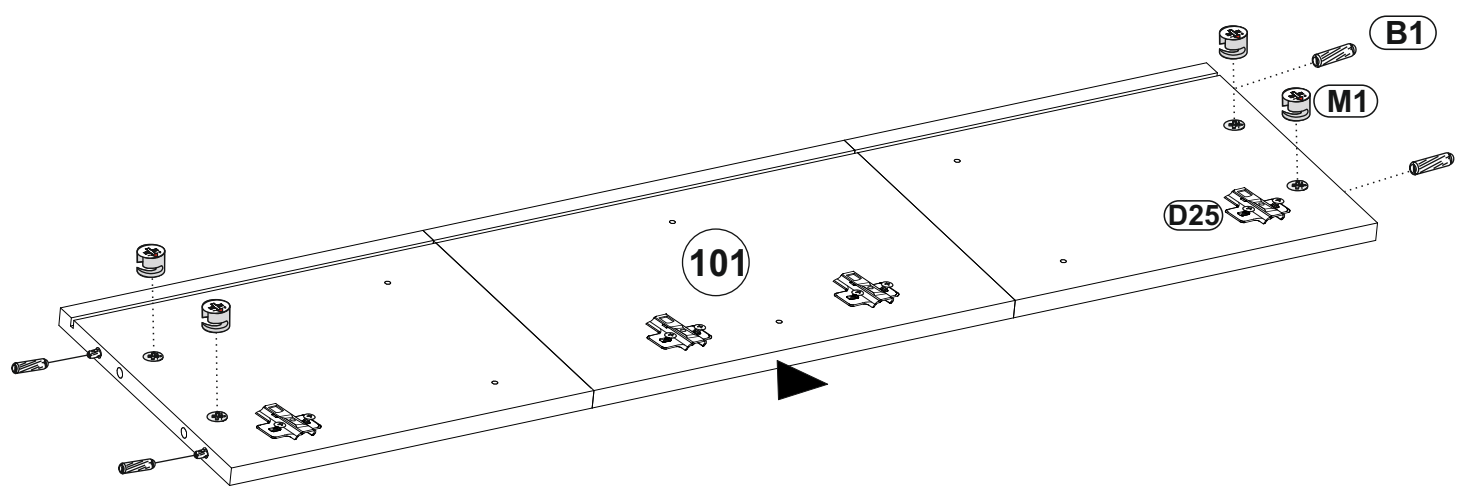
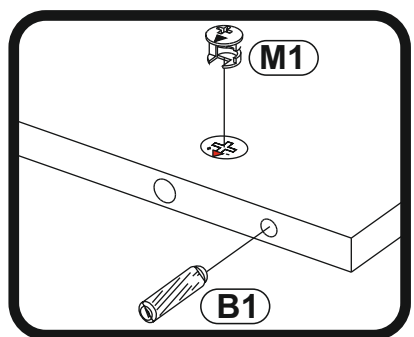
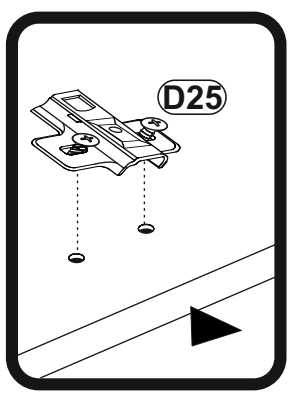

6

<b>B1</b> 8x28 x4	1018	<b>W3</b> x2	20075
<b>T1</b> x4	11809	<b>E11</b> ES 6x13 x2	3524
<b>M1</b> x4	123894	<b>D25</b> H0 x4	139391

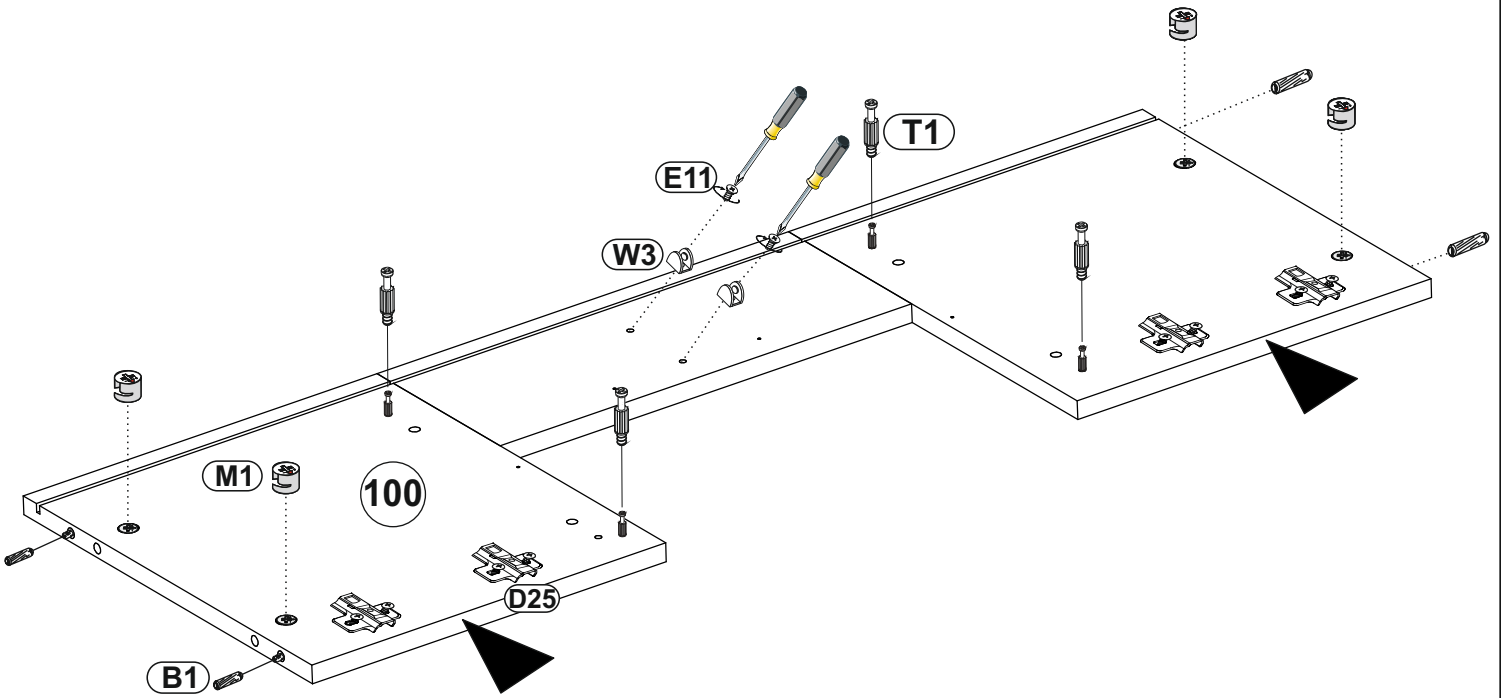
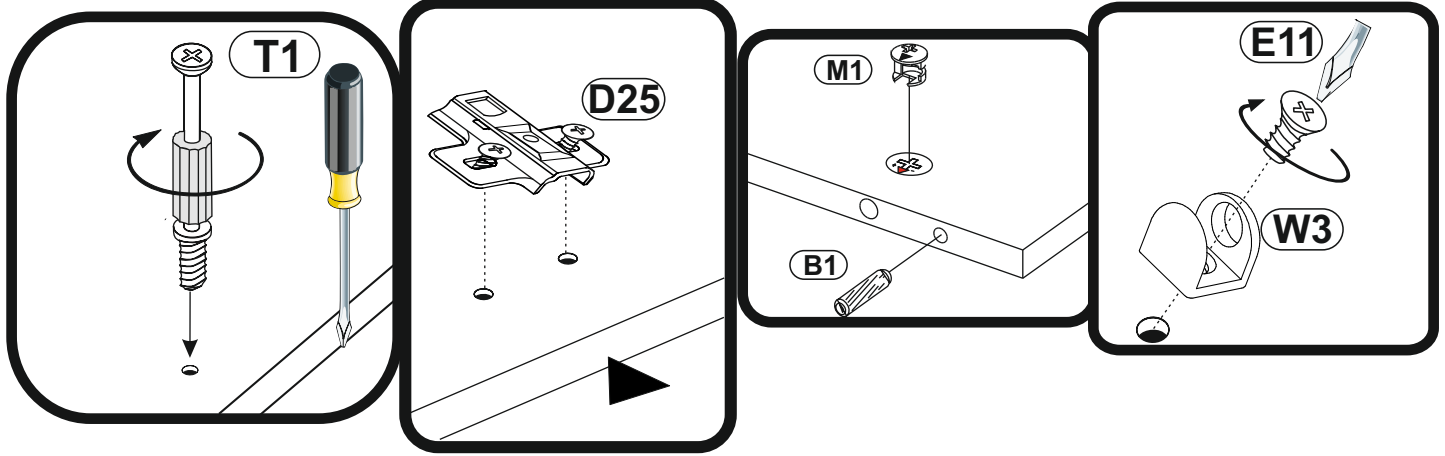

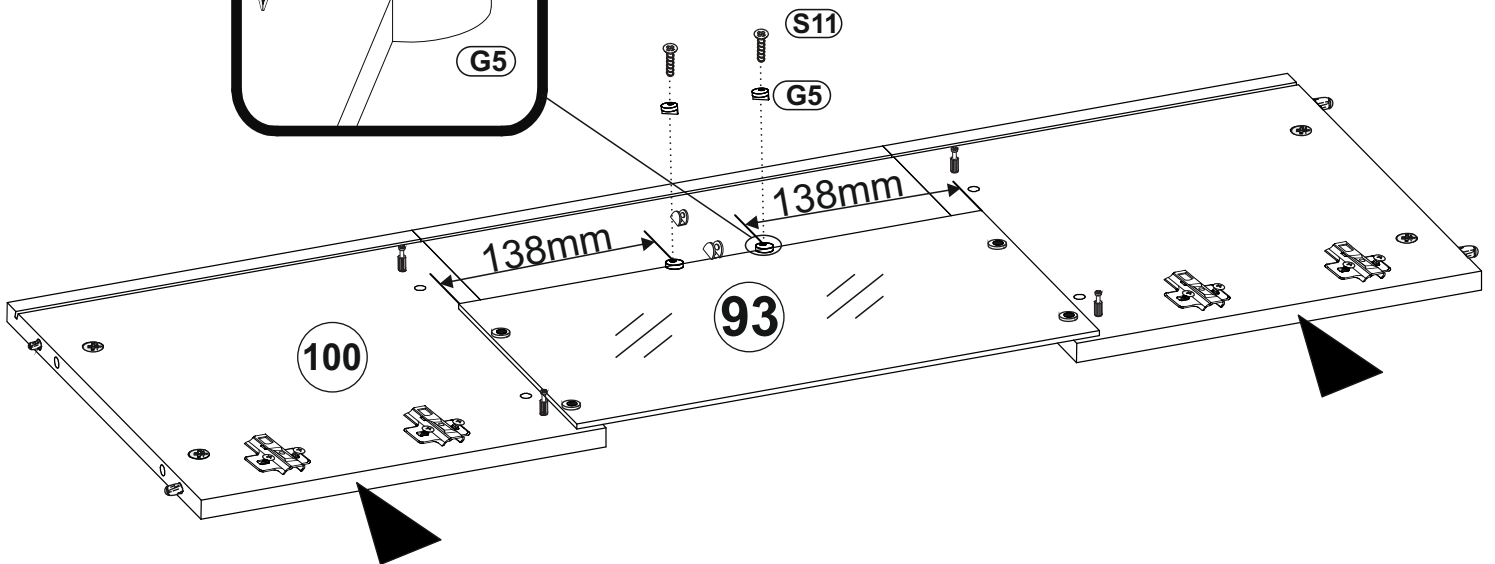
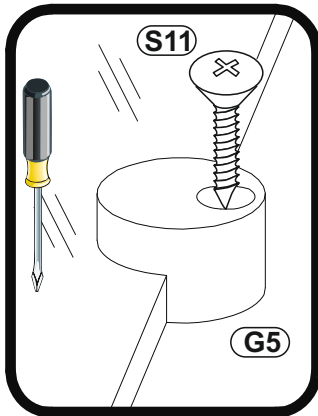
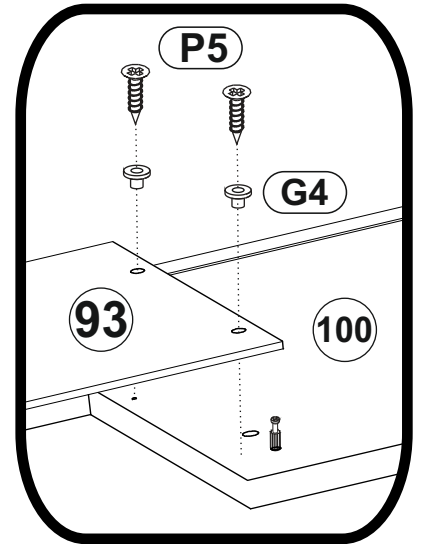
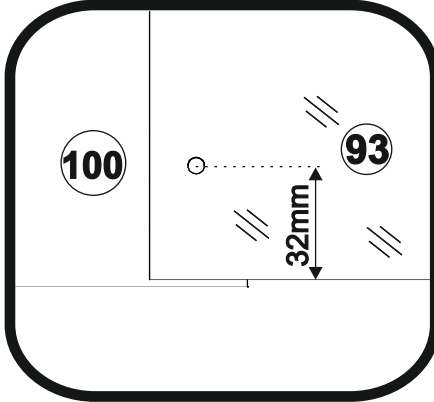
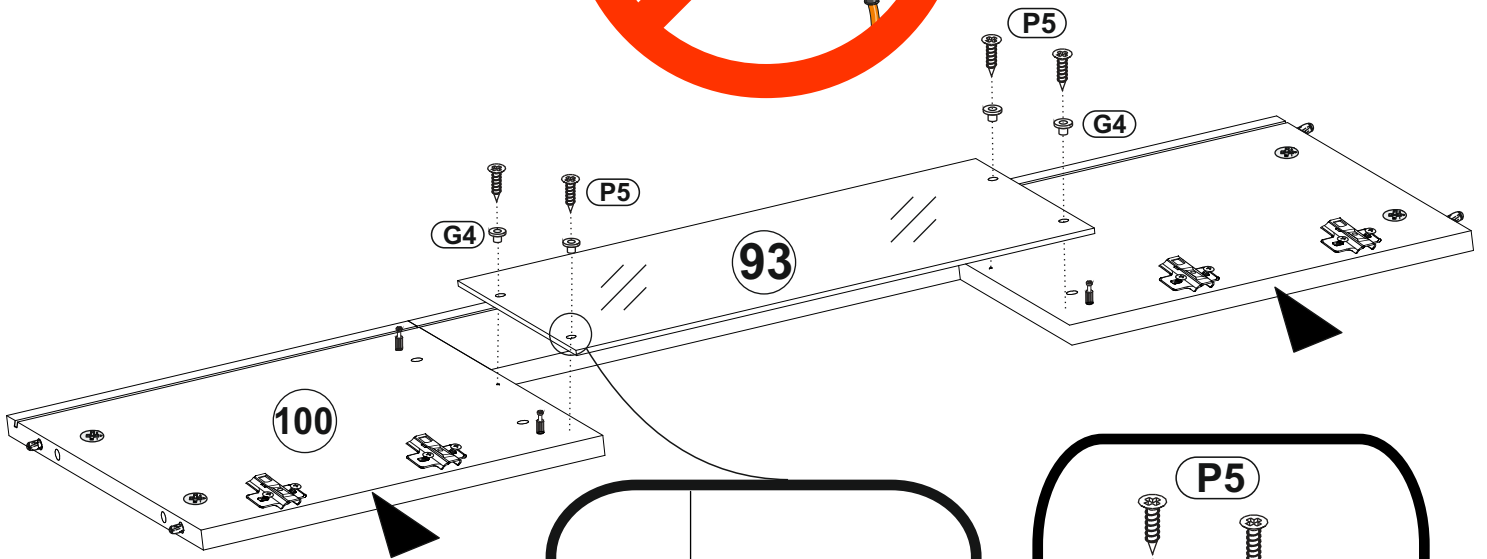
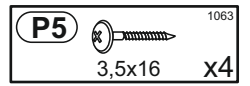
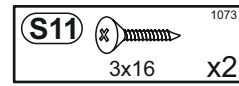
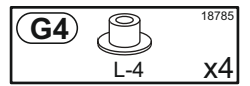
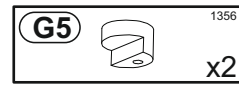
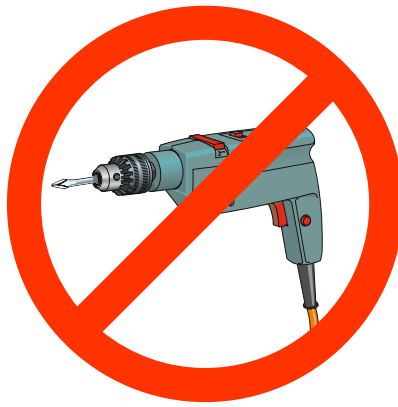

7

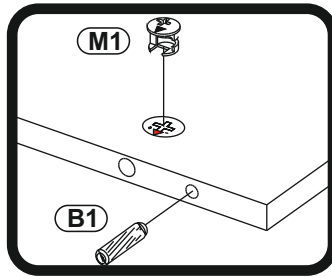
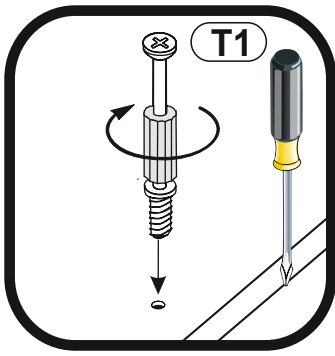

8

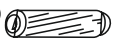

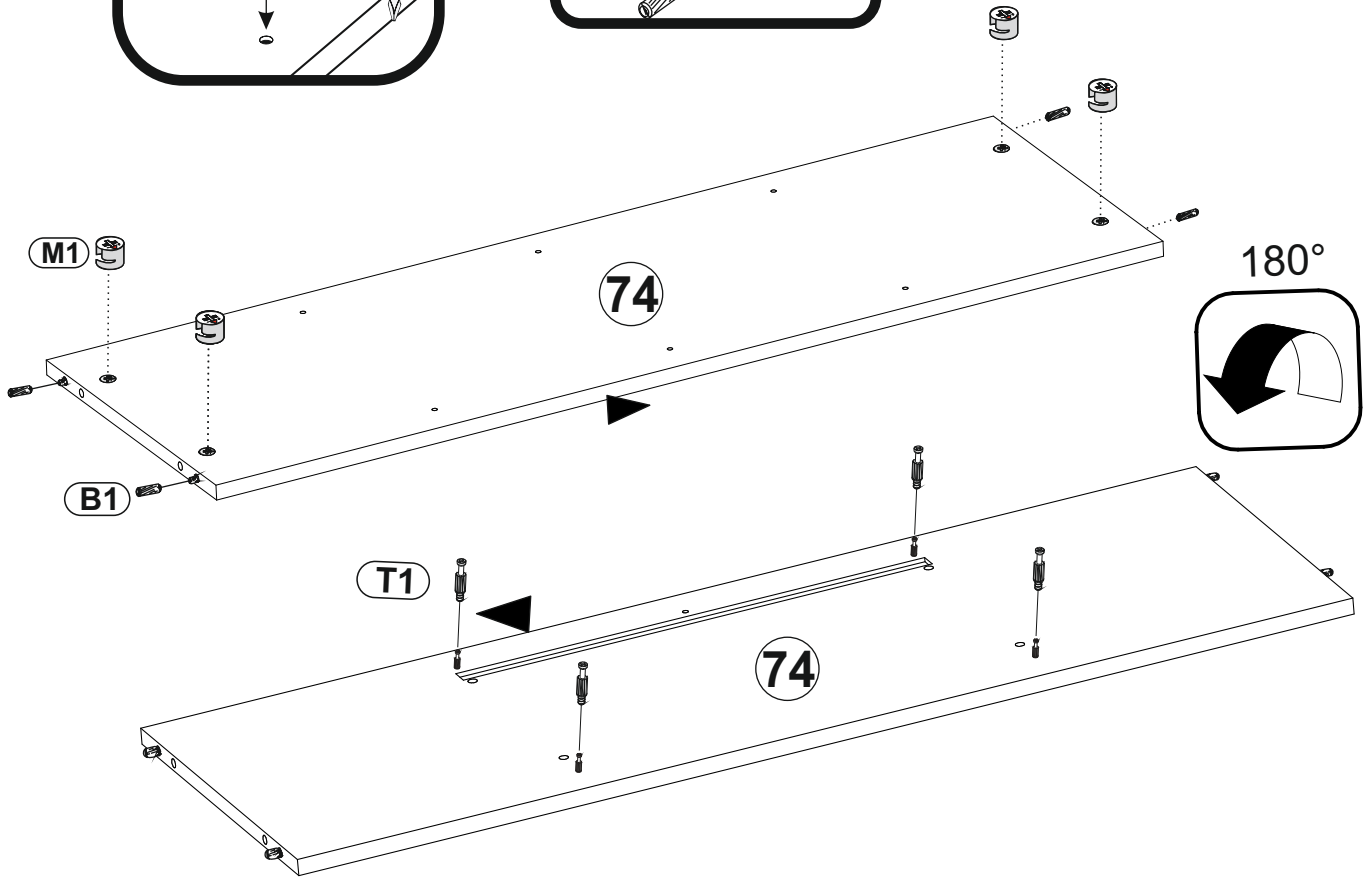

<b>B1</b>		1018
	8x28	x4
<b>T1</b>		11809
		x4
<b>M1</b>		123894
		x4

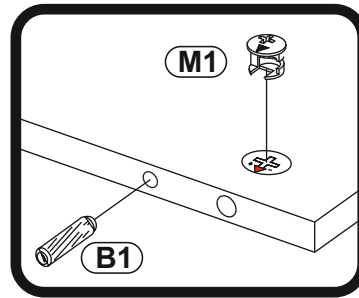

9

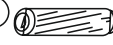

<b>B1</b>		1018
	8x28	x8
<b>M1</b>		123894
		x8

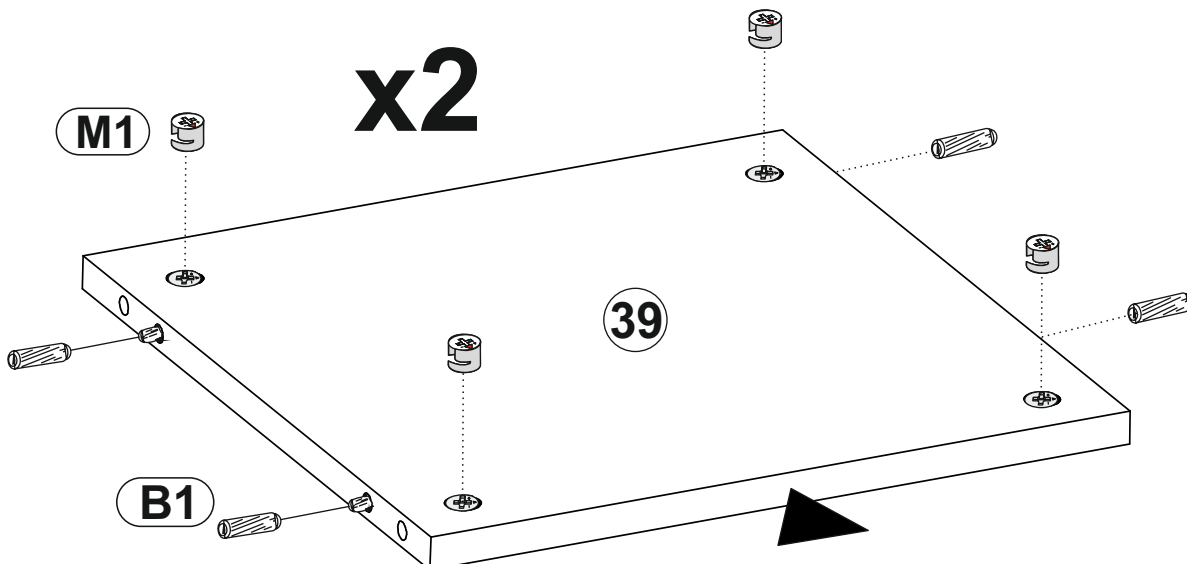



10

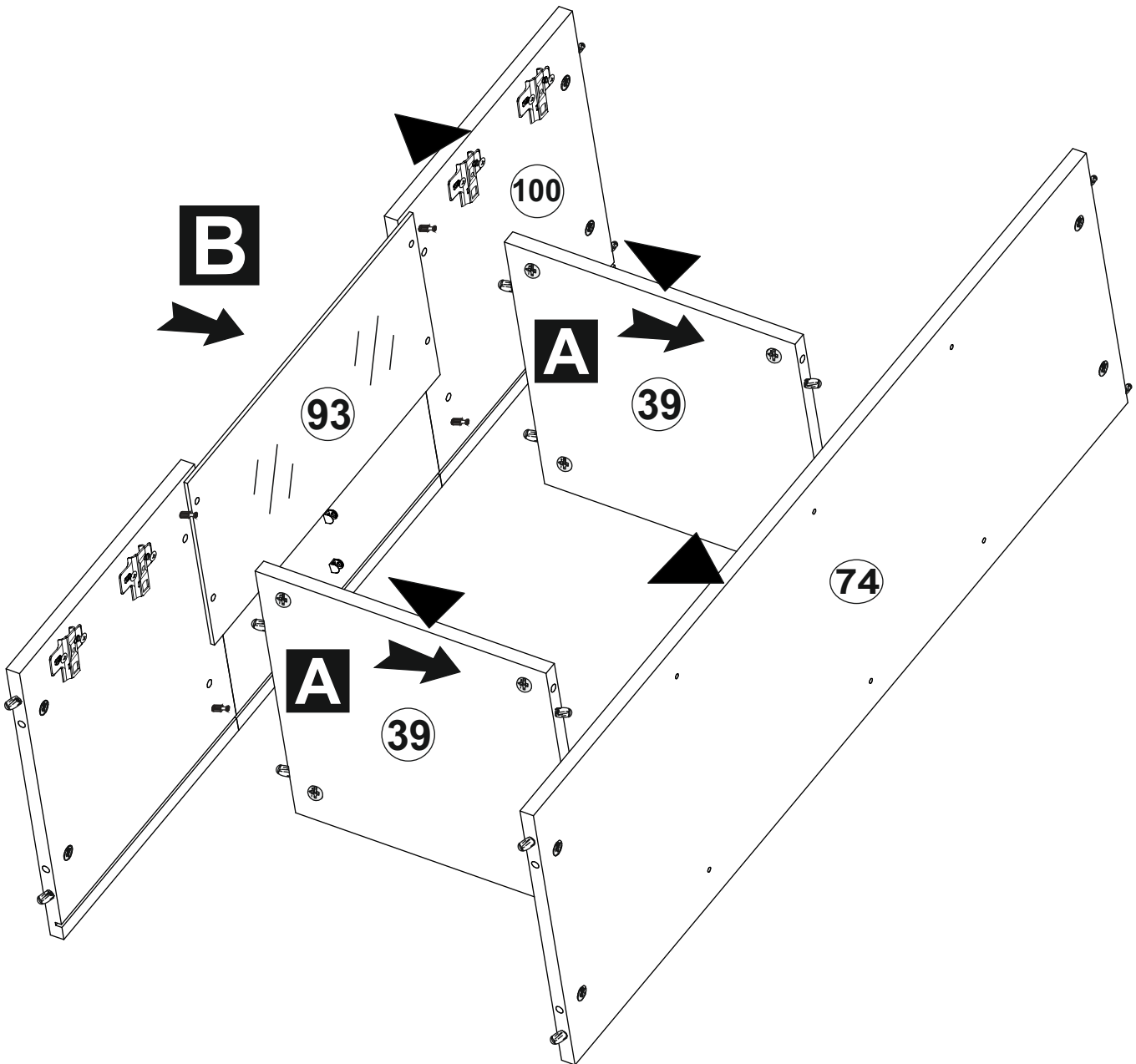
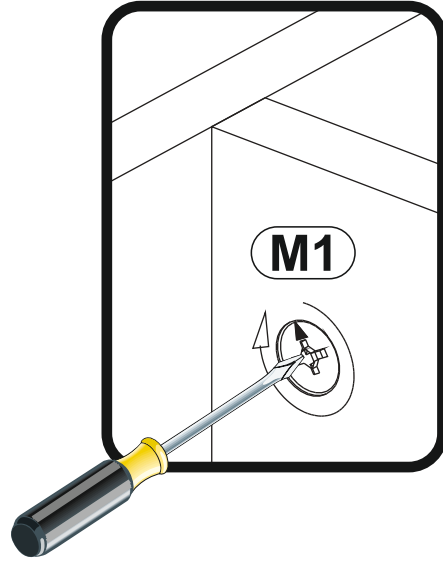
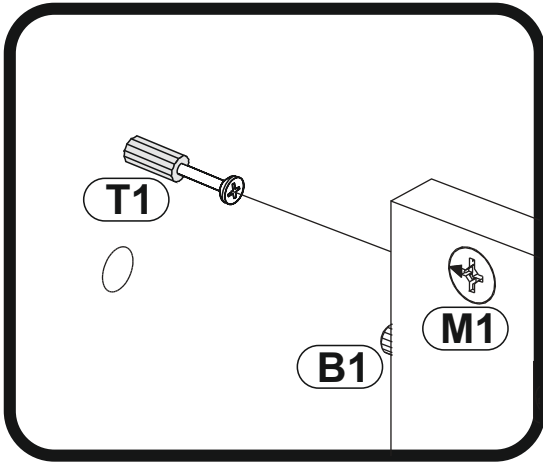

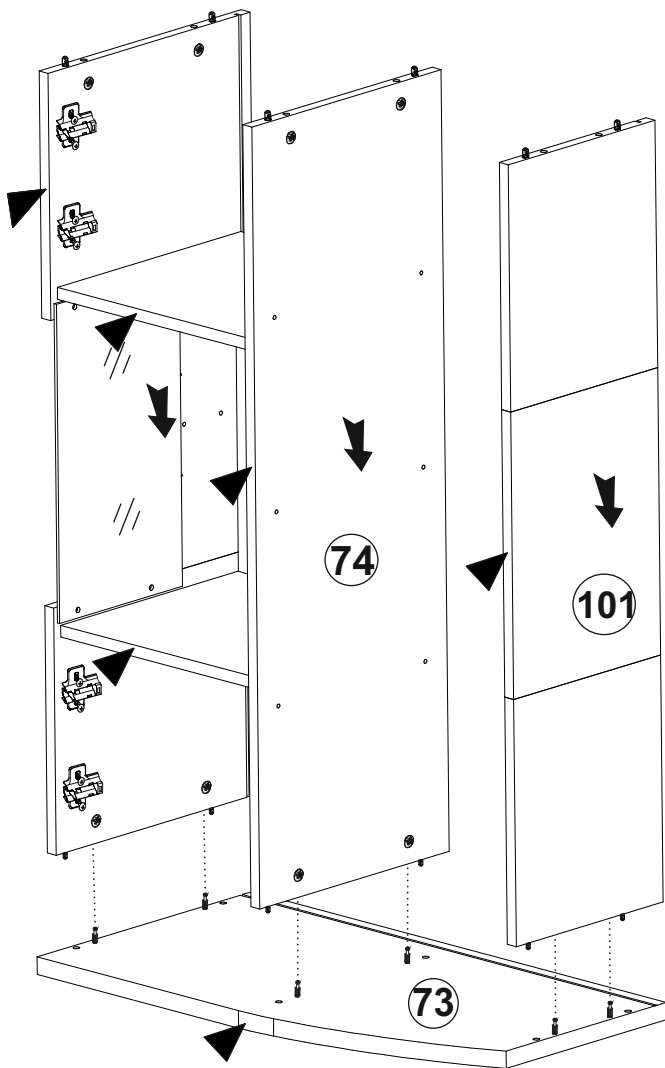

11



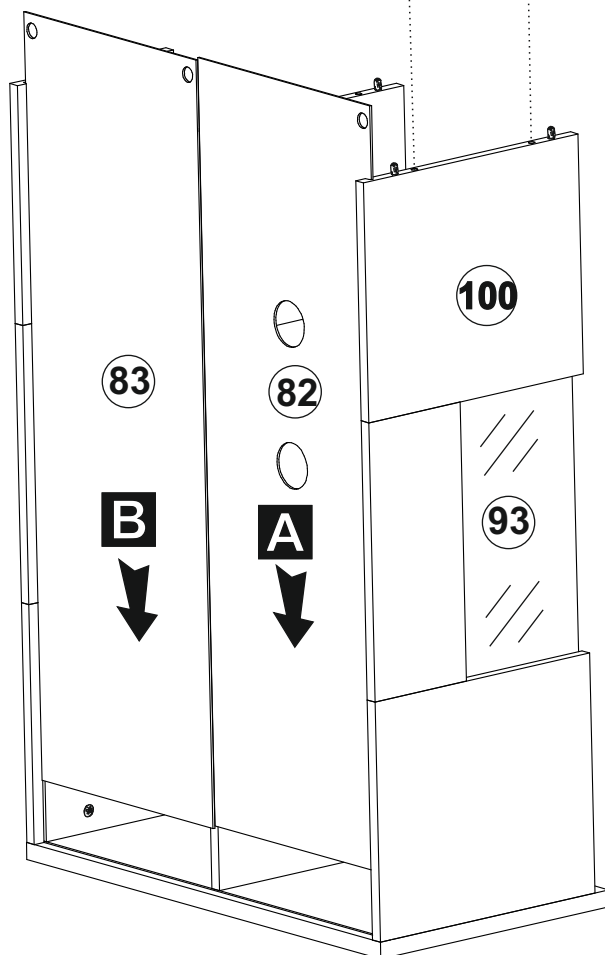
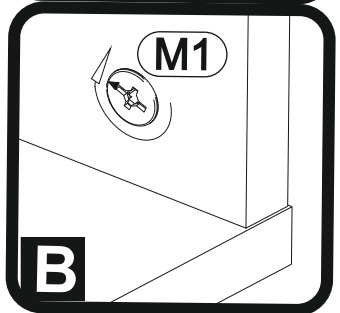
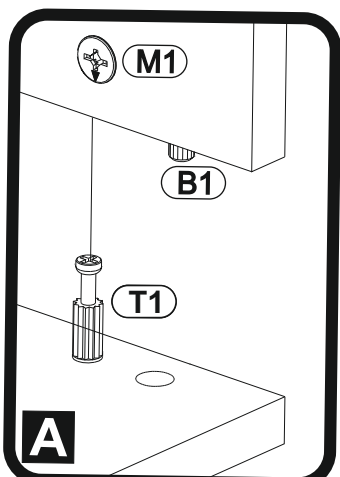
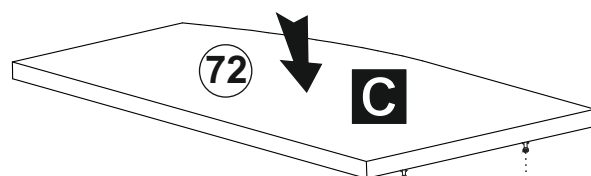
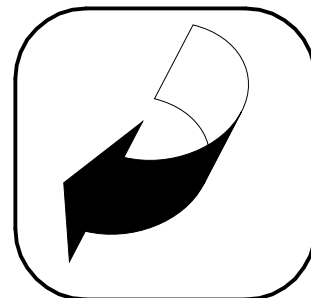

180°

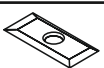

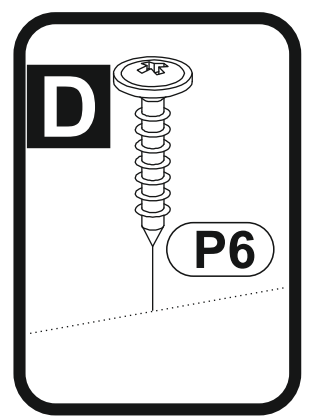
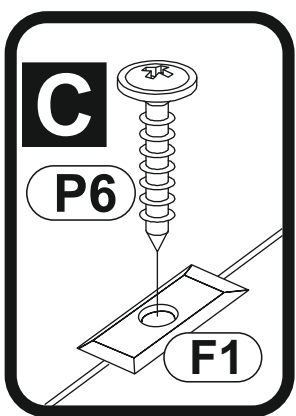
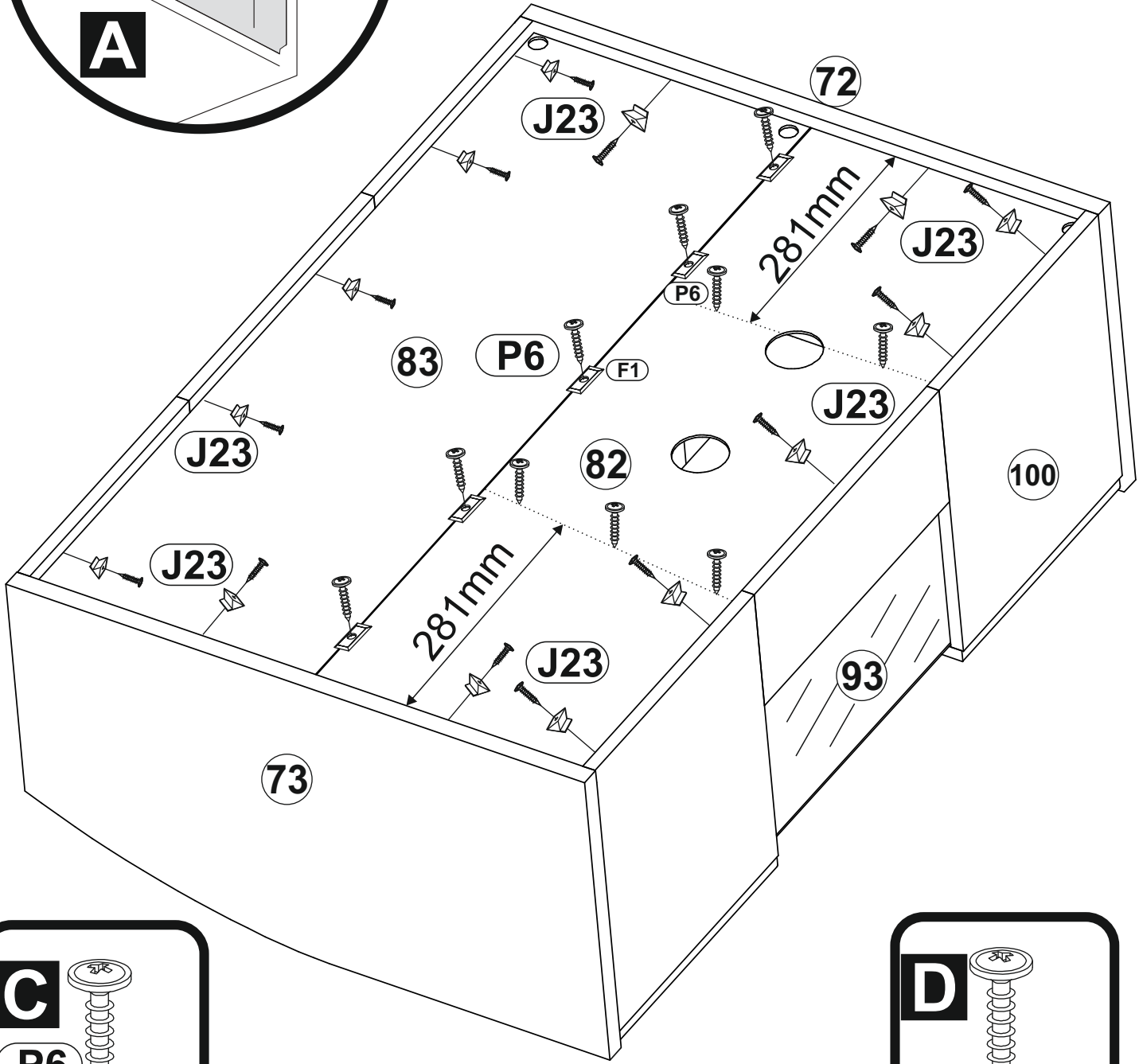
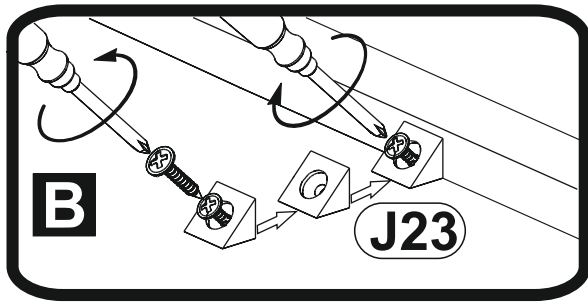
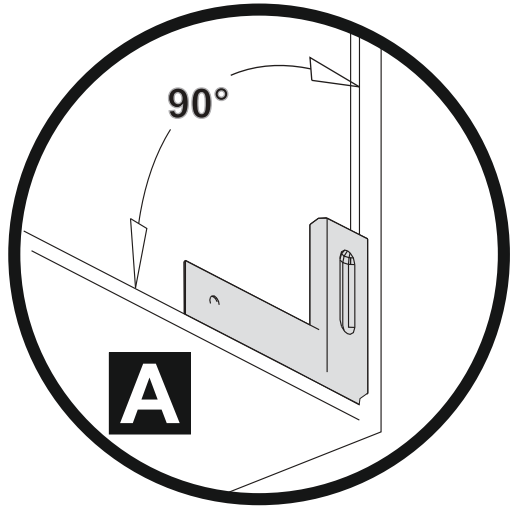
<b>J23</b>		1302
		x14
<b>P6</b>		1056
	3x20	x10
<b>F1</b>		1415
		x5

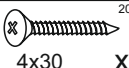

- W1**  1289 x12
- G60**  1968 x3
- S16**  2029 4x30 x6

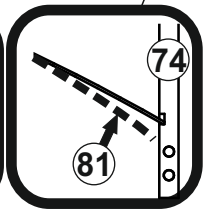
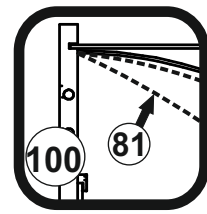
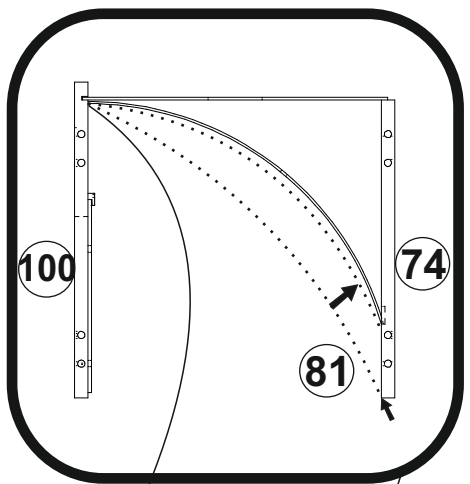
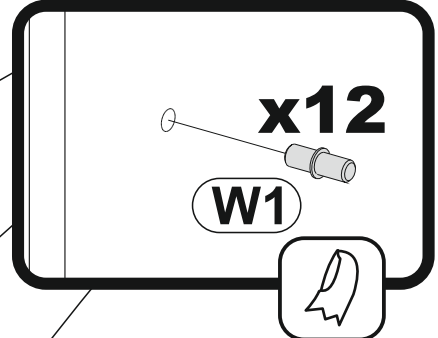
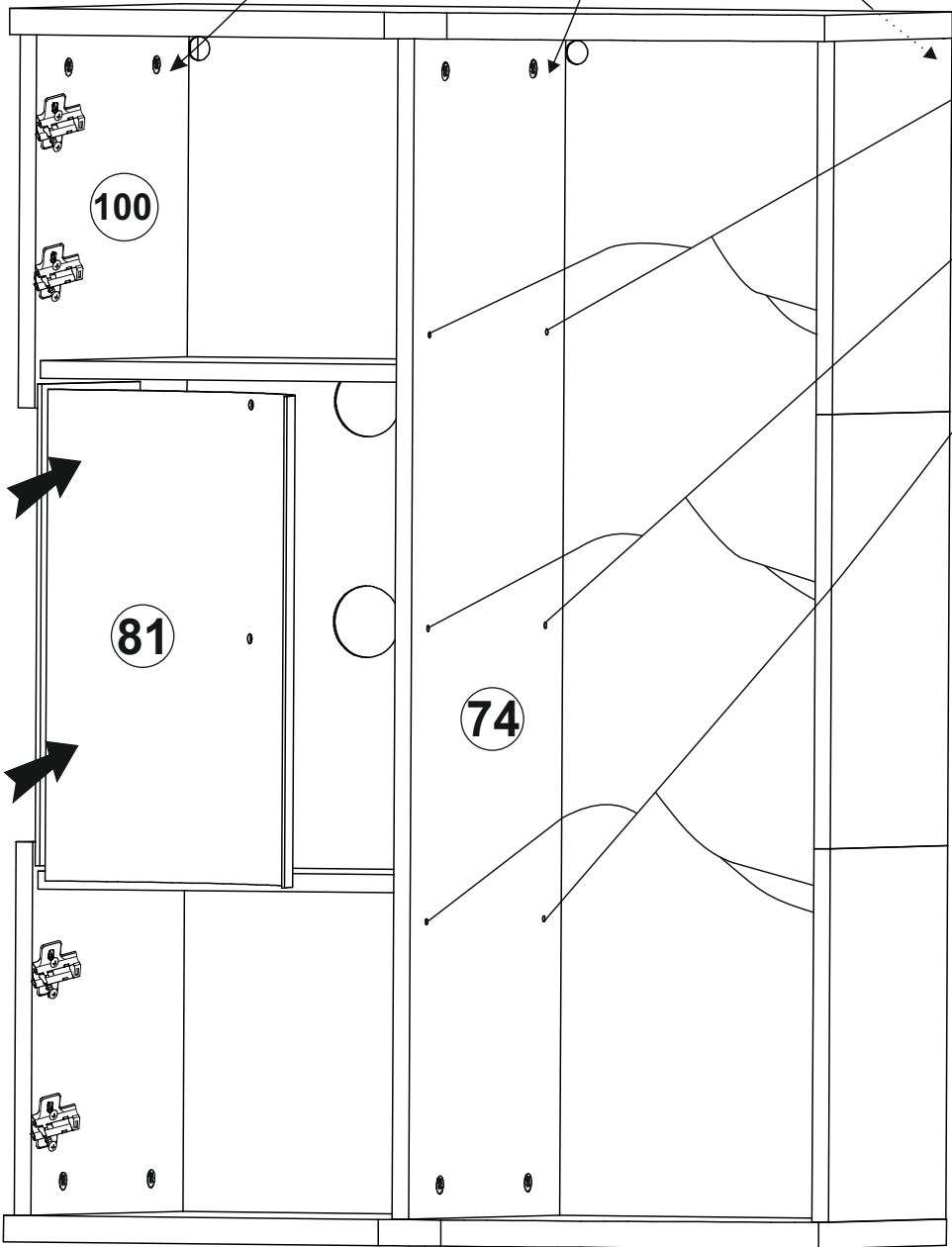
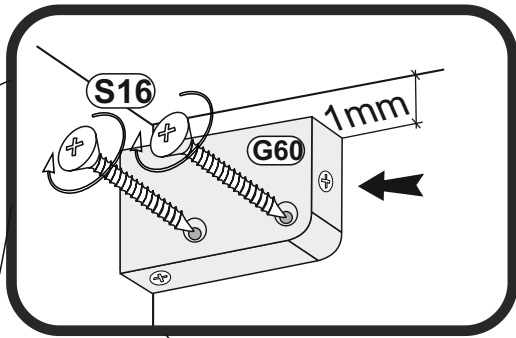

W3  20075 x1

E11  3524  
ES 6x13 x1

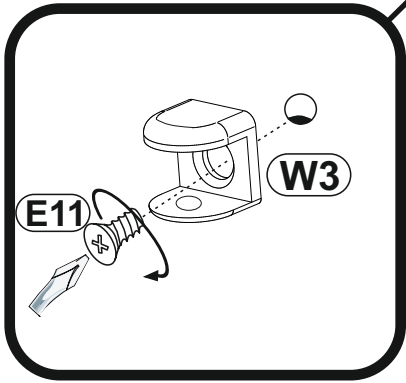
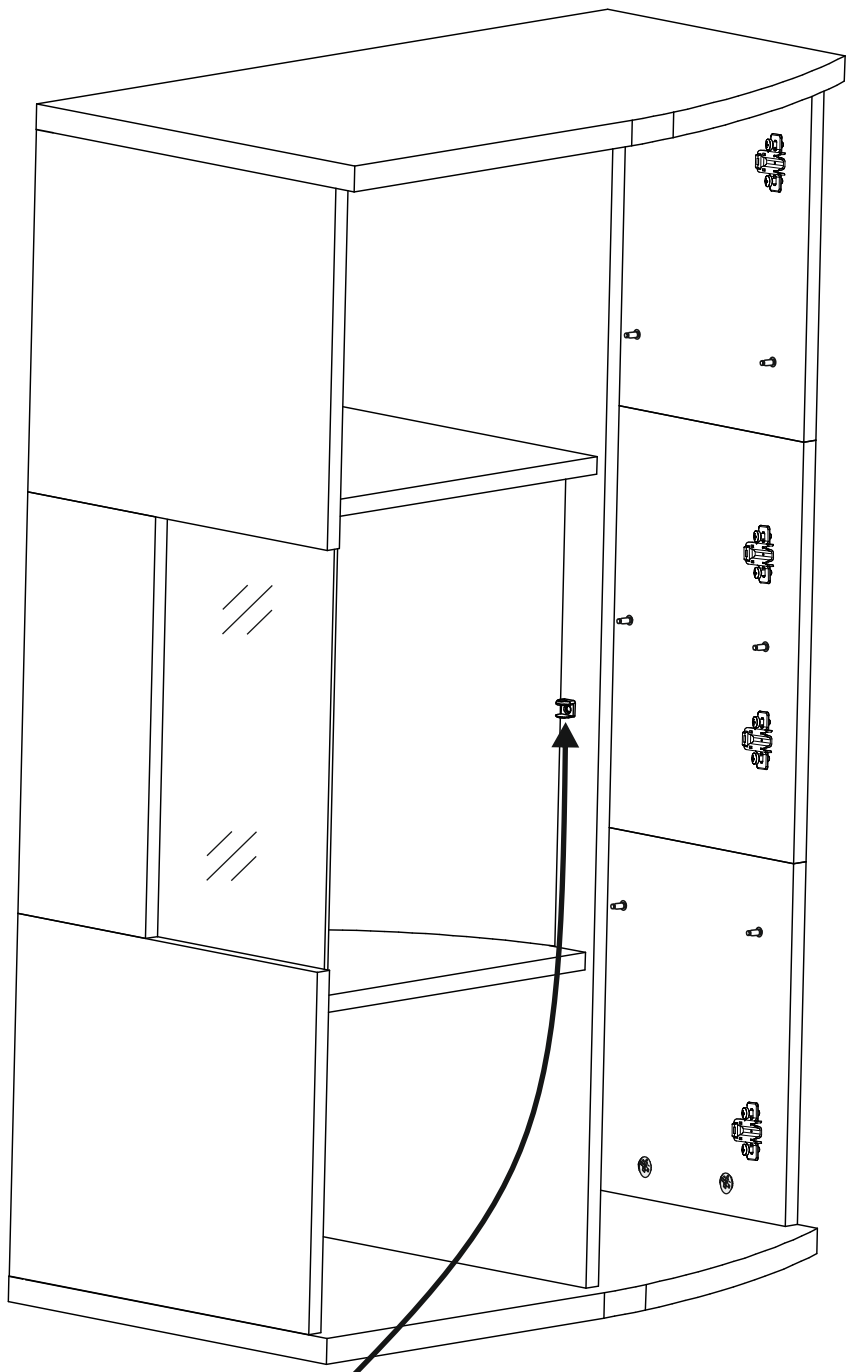

LED  
Option



LED  
Option



## LED OPTION

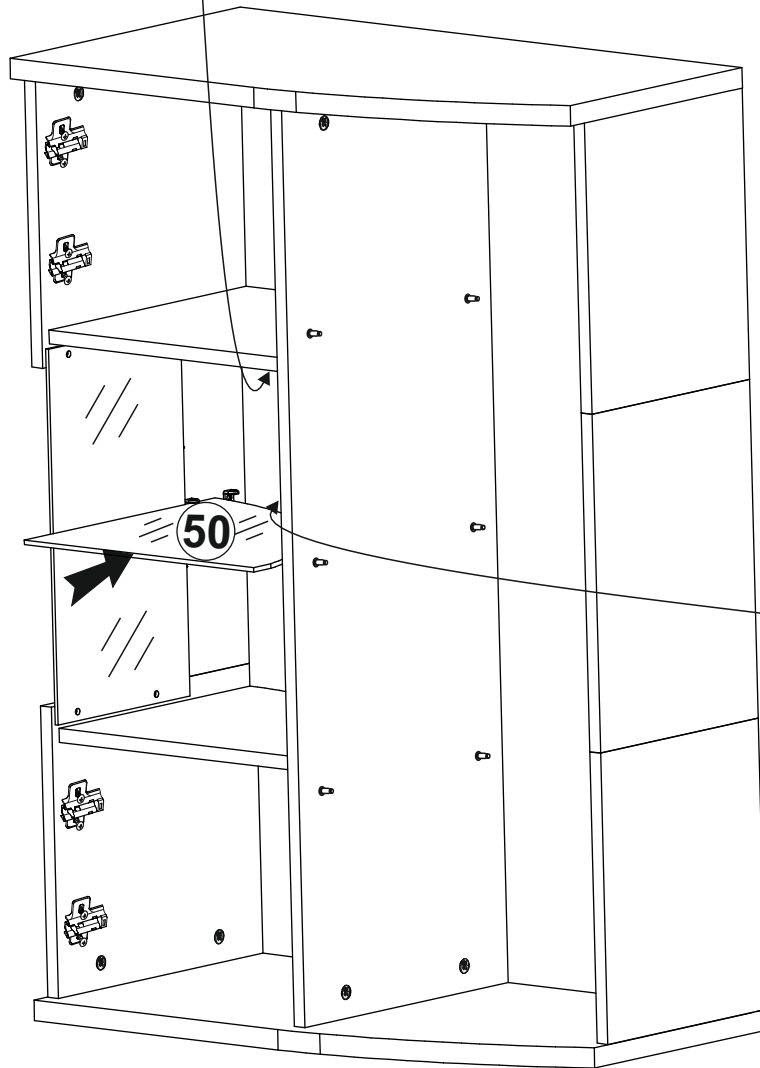
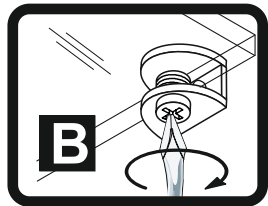
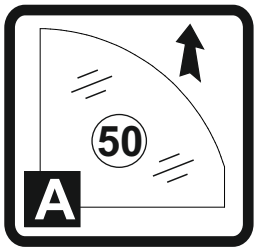
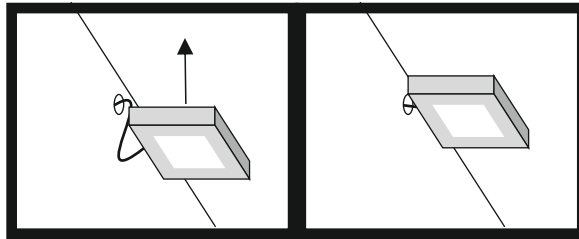

LED OPTION

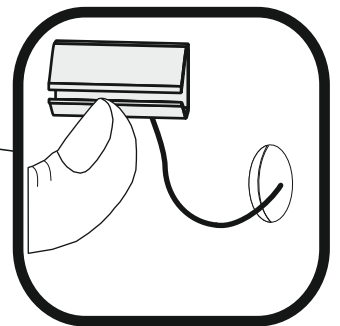

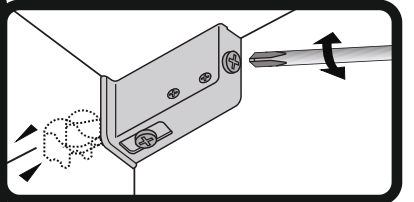
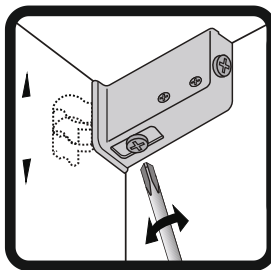
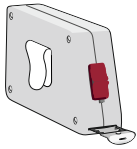
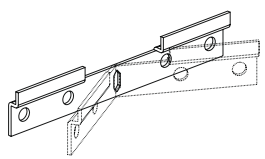
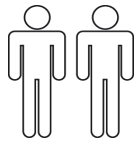
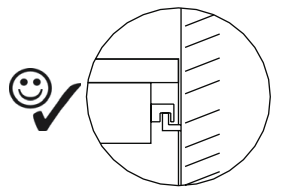
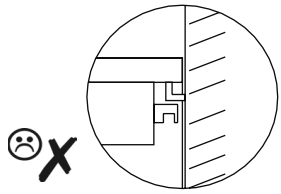
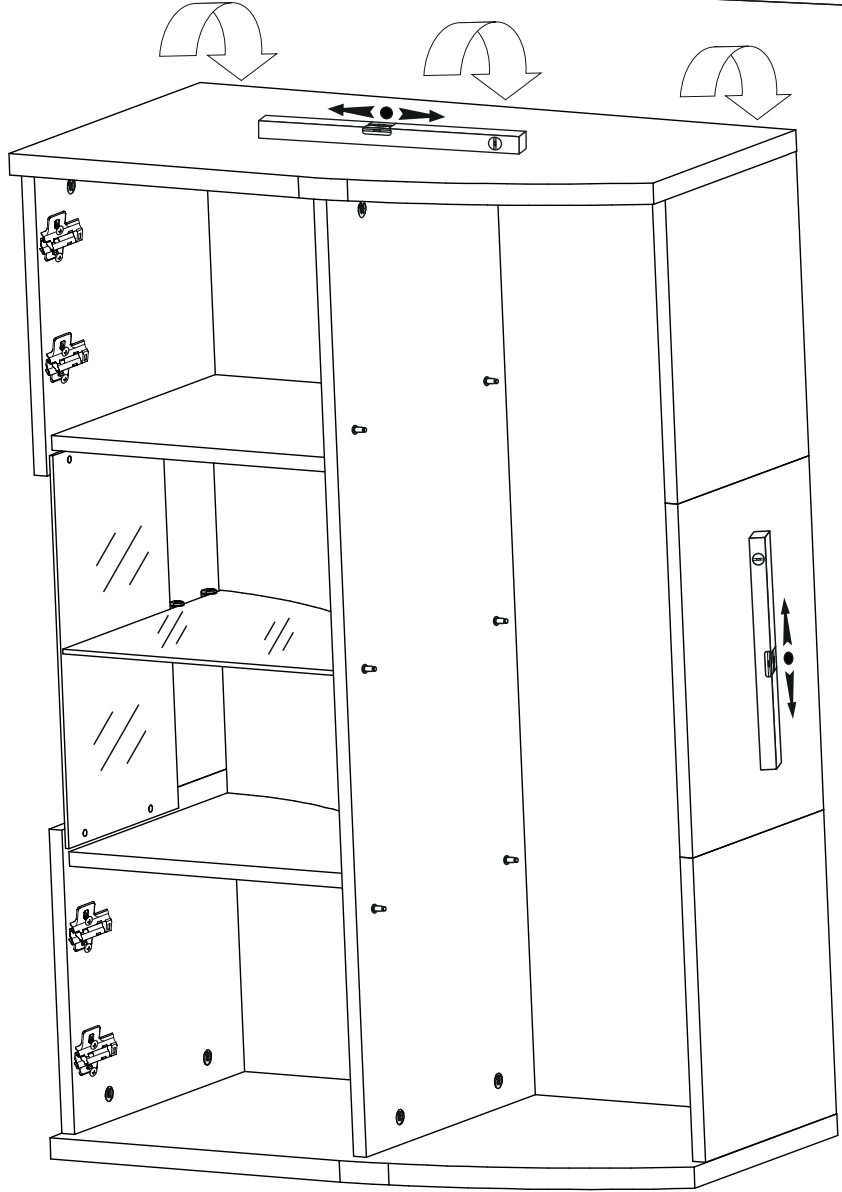
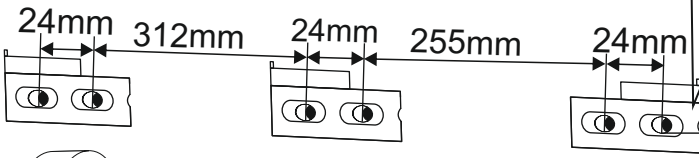
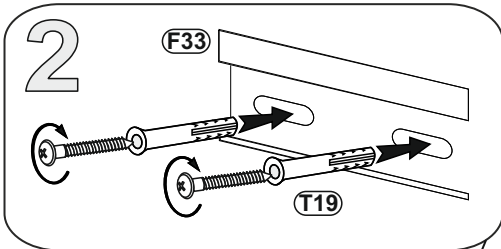
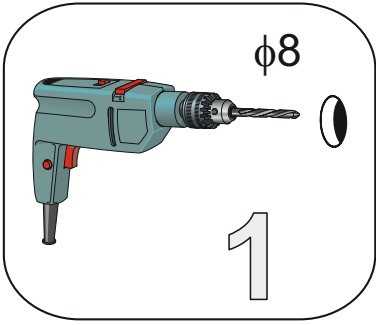
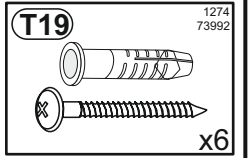
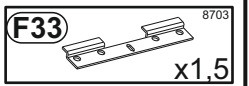
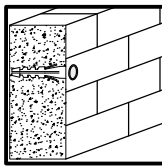
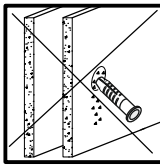

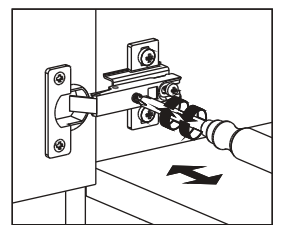
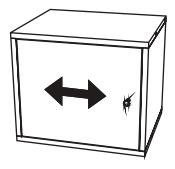
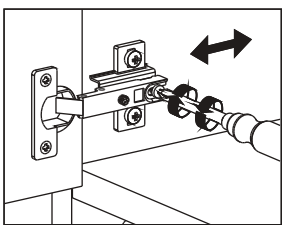
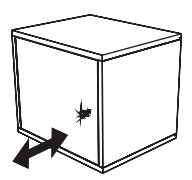
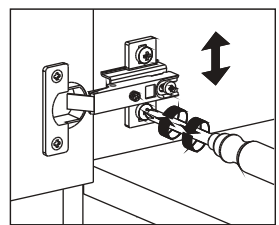
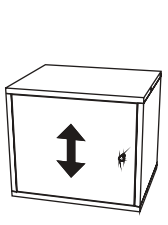
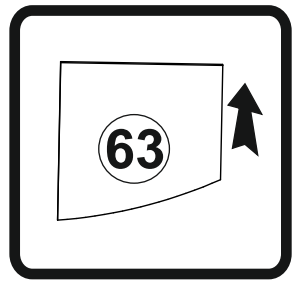
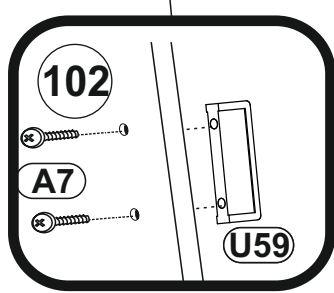
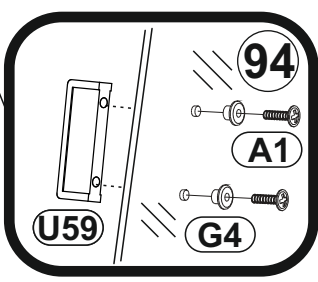
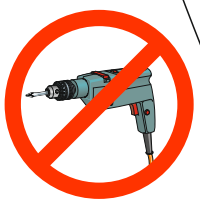
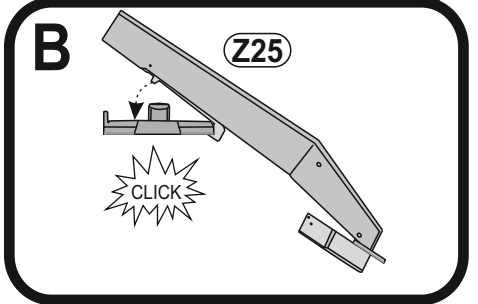
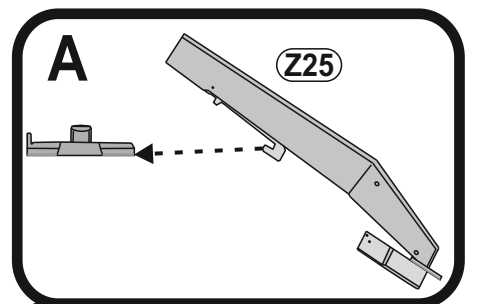
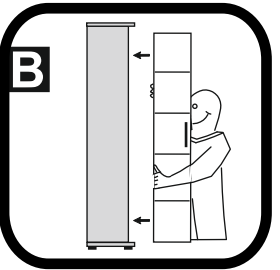
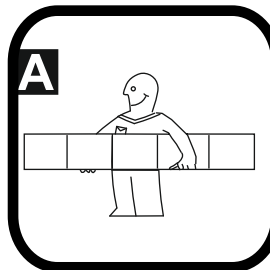
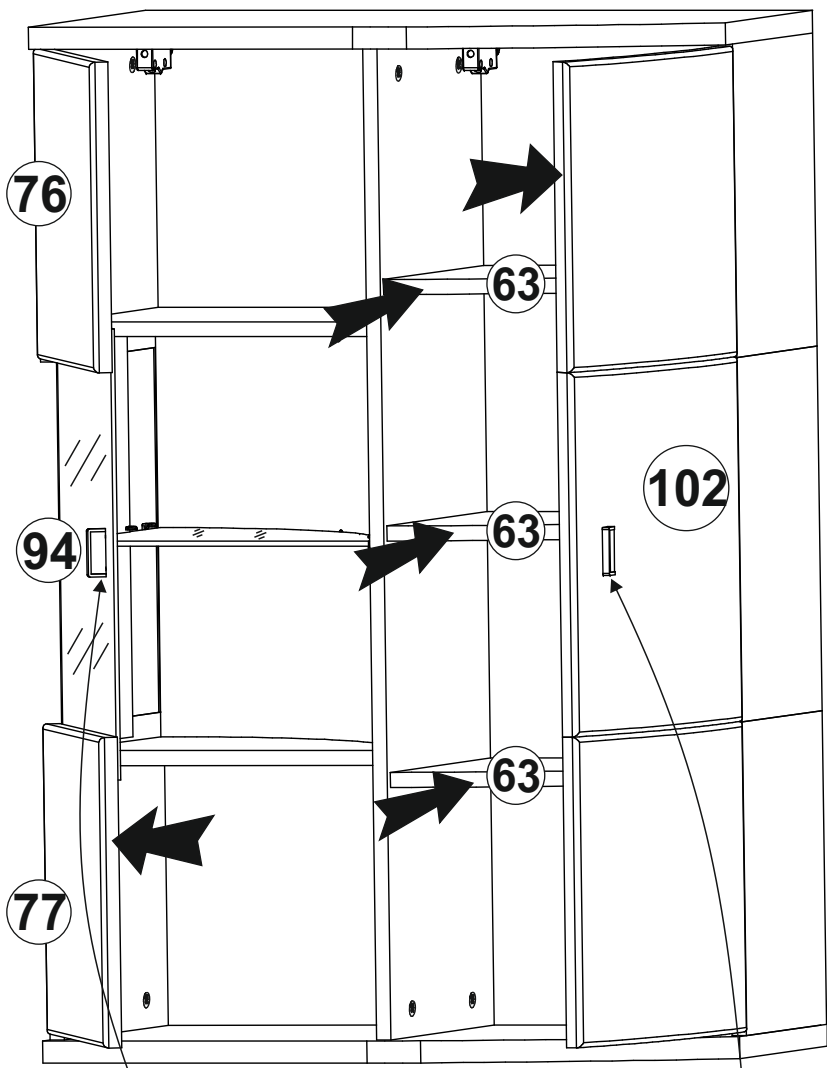
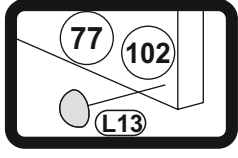
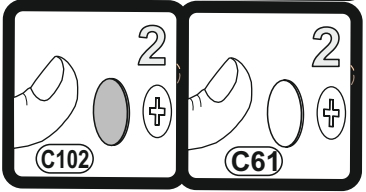
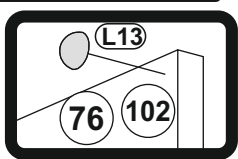
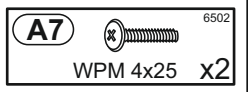
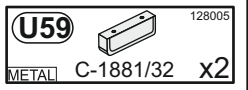
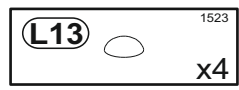
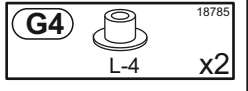
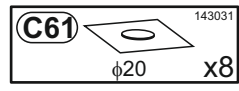
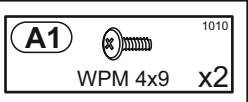
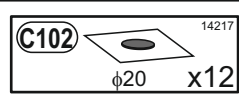
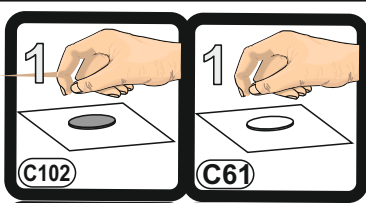
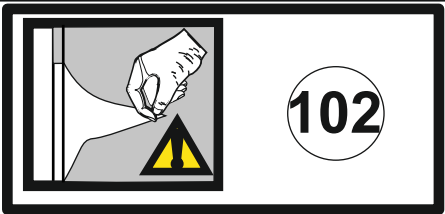



**(D) Sehr geehrter Kunde,**

als Möbelproduzent möchten wir Sie darüber informieren, dass eine Befestigung nur so gut ist wie die Verbindung zwischen Befestigungsmaterial (Dübel) und Mauerwerk. Prüfen Sie bei Hängeelementen Ihr Mauerwerk und verwenden Sie nur dafür vorgesehene Dübel aus einem Fachmarkt. Letztendlich ist der Monteur für die Befestigung am Mauerwerk verantwortlich.

Die Montage und das Verlegen der Elektroartikel sind nur von autorisiertem Fachpersonal durchzuführen. Beachten Sie die Beschreibungen und die Gewichtsangaben in der Montageanleitung.

Halten Sie bitte die angegebenen max. Gewichtsangaben ein. Bei Überlastungen, die durch spielende Kinder, Menschen, Material oder sonstige Einwirkungen entstehen -übernehmen wir als Möbelproduzent keine Haftung!

Die einwandfreie Funktion des Möbels ist nur bei lot- und waagerechter Aufstellung gewährleistet. Die Türen sind vorjustiert, müssen aber ggf. aufgrund örtlicher Bedingungen neu ausgerichtet / eingestellt werden!

Alle elektrischen Installationen sind nach den gültigen Normen bzw. Vorschriften von VDE, CE, MM gefertigt. Die zu verwendende Leuchtmittelstärke ist auf der jeweiligen Lampenfassung angegeben.

Bei Nichteinhaltung der max. Wattzahl besteht durch Überhitzung Brandgefahr. Das Zudecken der Leuchtmittel ist wegen Brandgefahr zu unterlassen!

Alle Schrauben sowie tragende Verbindungsstelle sollten nach 5 bis 6 Wochen nachgezogen werden, um eine dauerhafte Standsicherheit zu gewähren!

**Keine scheuernden Putzmittel verwenden!**

Werden Betriebs-, Bedienungs- oder Montageanweisungen nicht befolgt, Änderungen an den Produkten vorgenommen, Teile ausgewechselt oder Verbrauchsmaterialien verwendet, die nicht den Originalteilen entsprechen, so entfällt jegliche Gewährleistung oder Haftungsansprüche.

**Achtung Hinweis!**

Unsere Hochglanzoberflächen sind bei der Auslieferung durch eine Schutzfolie geschützt. Belassen Sie diese auf dem Möbel, bis es vollständig montiert und von Staub befreit ist.

Um die wertvolle Hochglanzoptik zu erhalten, sollten Sie

- der Hochglanzfolie nach der Entfernung der Schutzfolie eine Stunde Zeit zum Nachhärten an der Raum-Luft geben
- für die Reinigung der Oberflächen verwenden Sie nur ein feuchtes Baumwolltuch und etwas Glasreiniger. Kein scharfes Reinigungsmittel mit Zusatzstoffen verwenden.
- Oberflächen mit einem nassen Lappen abreiben keinen Dampfreiniger verwenden.
- Oberfläche nicht mit scharfen Gegenständen beschädigen
- Oberflächen auf gar keinen Fall starker Sonnenbestrahlung aussetzen

Wir wünschen Ihnen noch viel Freude mit Ihrem neuen Möbel.

**Ihre Produktentwicklung****(CZ) Vážený zákazník,**

jako výrobce nábytku bychom Vás chtěli informovat o tom, že upevnění je jen tak dobré, jak dobré je spojení mezi upevňovacím materiálem (hmoždinkou) a zdívkou. U závěsných prvků zkontrolujte příslušné zdívko a používejte jen vhodné hmoždinky, které nakoupíte v odborných obchodech. Za upevnění ve zdívu je nakonec zodpovědný ten, kdo upevnění montuje. Montáž a instalaci elektrických částí směřjí provádět jen pověřeni odborní pracovníci. Dodržujte popisy a údaje o hmotnosti uvedené v návodu k montáži. Dodržujte uvedené údaje o maximální hmotnosti při přetížení, které je způsobeno hrajícími si dětmi, lidmi, materiálem nebo jinými vlivy, nepřebíráme jako výrobce nábytku záruku! Bezvadná funkce nábytku je zaručena jen při postavení nábytku ve správné svislé a vodorovné poloze. Dvířka jsou předem nastavená, případně je ale nutné je znovu seřídít / nastavit podle místních podmínek! Všechny elektrické instalace jsou provedeny podle platných norem příp. předpisů VDE (svaz německých elektrotechniků), CE, MM. Intenzita žárovky/zdroje světla, která se má použít, je uvedena na příslušné objímce žárovky/zdroje světla. Při nedodržení maximálního výkonu ve Wattech hrozí nebezpečí znicení kvůli přehřátí. Zakrytí žárovky/zdroje světla je kvůli nebezpečí požáru zakázáno! Všechny šrouby a nosné spojovací prvky se mají po 5 až 6 týdnech dotáhnout, čímž se zajistí trvalá stabilita!

**Nepoužívejte žádné abrazivní čisticí prostředky!**

Pokud se nedodržují pokyny k provozu, návodu nebo montáži, provádějí se úpravy výrobků, vyměňují se díly za neoriginální nebo se používá spotřební materiál, který neodpovídá originálnímu, zaniká záruka nebo nároky plynoucí z odpovědnosti.

**Pozor upozornění!**

Naše povrchy s vysokým leskem jsou při dodání chráněny ochrannou fólií. Ponechejte ji na nábytku, dokud nebude kompletně smontovaný a nebude z něho odstraněný prach.

Aby se zachovala cenná optika vysokého lesku, měli byste: dát vysoce lesklé fólii po odstranění ochranné fólie hodinu čas na vytvrzení na pokojovém vzduchu, pro čištění povrchů používejte pouze vlhký bavlněný hadřík a trochu čisticího prostředku na skla. nepoužívejte ostrý čisticí prostředek s příměsí, povrchy otírejte mokřím hadrem, nepoužívejte parní čistič. nepoškodte povrch ostrými předměty povrchy v žádném případě nevystavujte silnému slunečnímu záření

Přejeme Vám hodně radosti s Vaším novým nábytkem.

**Vaše oddělení vývoje nových výrobků****(GB) Dear Customer,**

As a furniture manufacturer we would like to point out that an attachment is only as good as the connection between the attachment material (dowel) and masonry. In the case of suspension elements you should check your masonry and only use the appropriate dowels from a specialist store. Ultimately it is the person carrying out the installation who is responsible for attachment to the masonry.

The installation and laying of electrical lines and other items must only be performed by authorised specialists. Please note the descriptions and weight information in the installation instructions.

Please observe the stated maximum weights; in the case of mechanical overloads caused by playing children, other individuals, materials etc. we do not accept any liability as the manufacturer of the furniture!

The furniture is only guaranteed to work perfectly if it is set up to be plumb and horizontal. The doors have been pre-adjusted, but may need to be realigned/readjusted in accordance with local conditions!

All electrical installations have been produced in accordance with the latest norms and regulations, such as those of the VDE (Association of German Electrical Engineers), CE and MM. The power of the bulbs to be used is marked on the respective light fitting.

If the maximum number of watts stated on the fitting is not complied with, there is a danger of fire from overheating. Covering the lamps and bulbs is strictly prohibited due to the danger of fire!

All screws and load-bearing connecting parts should be tightened after 5 to 6 weeks in order to ensure long-term stability!

**Do not use any abrasive cleaning materials!**

If the operating or installation instructions are not complied with, modifications are carried out to the products, parts replaced or consumable materials used which do not correspond to the original parts, all warranty or liability claims shall become null and void.

**Attention! Notice!**

Our high gloss surfaces have a protective foil when delivered.

Please leave this foil on the furniture until it is completely assembled and all dust has been removed.

To maintain the valuable high gloss appearance, you should

- expose the high gloss foil to the room air for an hour to allow it to harden after removing the protective foil.
- only use a damp cotton cloth and a small amount of glass cleaner to clean the surfaces.
- Do not use any aggressive cleaners with additives.
- Rub off the surfaces with a wet rag.
- Do not use a steam cleaner.
- Do not damage the surface with sharp objects.
- Do not in any case expose the surfaces to intense sunlight

We wish you plenty of enjoyment with your new furniture.

**Your product development team****(FR) Cher client,**

En tant que fabricant de meubles, nous souhaitons attirer votre attention sur le fait que la meilleure des fixations n'est rien sans la qualité du raccord entre le matériel de fixation (cheville) et la maçonnerie. Par conséquent, pensez à vérifier la maçonnerie avant d'accrocher les éléments hauts et utilisez uniquement les chevilles prévues à cette fin, achetées dans une grande surface spécialisée. En fin de compte, c'est l'installateur qui sera responsable de la fixation à la maçonnerie.

Le montage et la pose des articles d'électroménager sont strictement l'affaire d'un personnel qualifié, dûment habilité. Veuillez observer les descriptions et les poids indiqués dans la notice de montage.

Veuillez respecter les poids maxi spécifiés ; en tant que fabricant de meubles, nous déclinons toute responsabilité en cas de surcharges causées par des enfants qui jouent, d'autres personnes, du matériel divers ou provoquées par d'autres influences !

Pour assurer le fonctionnement irréprochable du meuble, il faut veiller à l'installer parfaitement d'aplomb et à l'horizontale. Les portes sont préajustées, mais il sera peut-être nécessaire de les réaligner/régler à nouveau sur place !

Toutes les installations électriques sont fabriquées selon les normes et prescriptions VDE, CE, MM en vigueur. La puissance à utiliser est précisée sur la douille de chaque lampe.

Si le wattage max. n'est pas respecté, il existe un risque d'incendie dû à la surchauffe. Il est interdit de recouvrir la lampe, en raison du risque d'incendie ! Il faut resserrer toutes les vis et les éléments de raccord porteurs après 5 à 6 semaines, pour assurer une stabilité durable !

**N'employez en aucun cas des nettoyeurs abrasifs !**

Si les instructions de service, de commande ou de montage ne sont pas respectées, si des modifications sont apportées aux produits ou bien encore si des pièces sont remplacées ou si des consommables qui ne correspondent pas aux pièces d'origine sont utilisés, nous n'assumons alors aucune garantie et nous déclinons toute responsabilité dans ces cas.

**Attention Remarque !**

Nos surfaces haute brillance sont protégées à la livraison par un film protecteur. Veuillez le laisser sur le meuble jusqu'à ce qu'il soit entièrement installé et que la poussière soit supprimée.

Pour obtenir un aspect de qualité et de haute brillance, vous devez

laisser durcir pendant une heure à l'air ambiant le film haute brillance après avoir enlevé le film protecteur pour le nettoyage des surfaces, utiliser uniquement un chiffon de coton humide et un peu de lave-verre.

Ne pas utiliser de détergent agressif comportant des addi-tifs.

Frotter les surfaces avec un chiffon humide.

Ne pas utiliser de nettoyeur à vapeur.

Ne pas endommager la surface avec des objets coupants

ne pas soumettre les surfaces à un fort rayonnement solaire

Nous souhaitons que votre nouveau meuble vous donne entière satisfaction.

**Votre service de développement de produits**





# DERA 051

# A4DAQT051



Information zur Reklamationsbearbeitung:  
Geben Sie bitte bei Reklamationen Modellnummer, Type sowie die Ersatzteilnummer der benötigten Bauteile an. Ebenfalls müssen Sie Ihre Auftragsnummer angeben.

Telefon : 05221-342790

Fax : 05221-342 7929

Mail : kundendienst@forestdream.de

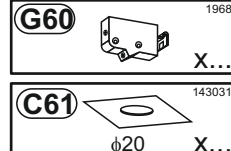
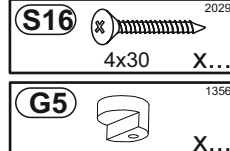
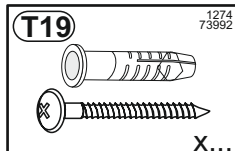
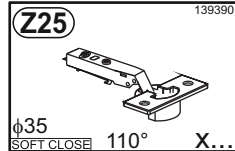
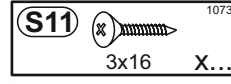
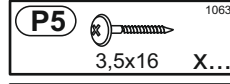
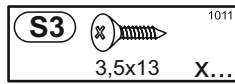
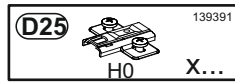
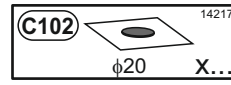
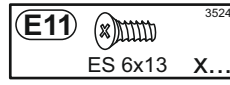
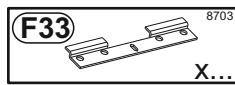
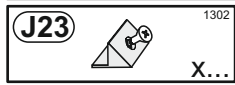
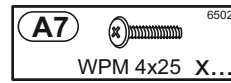
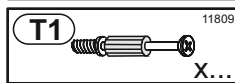
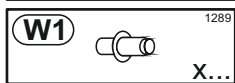
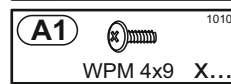
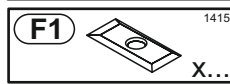
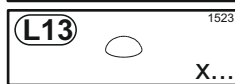
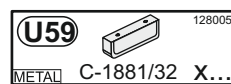
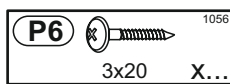
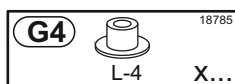
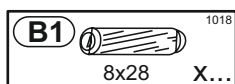
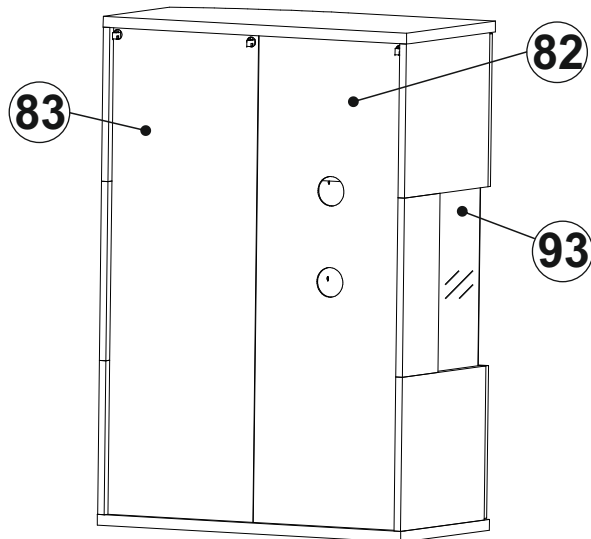
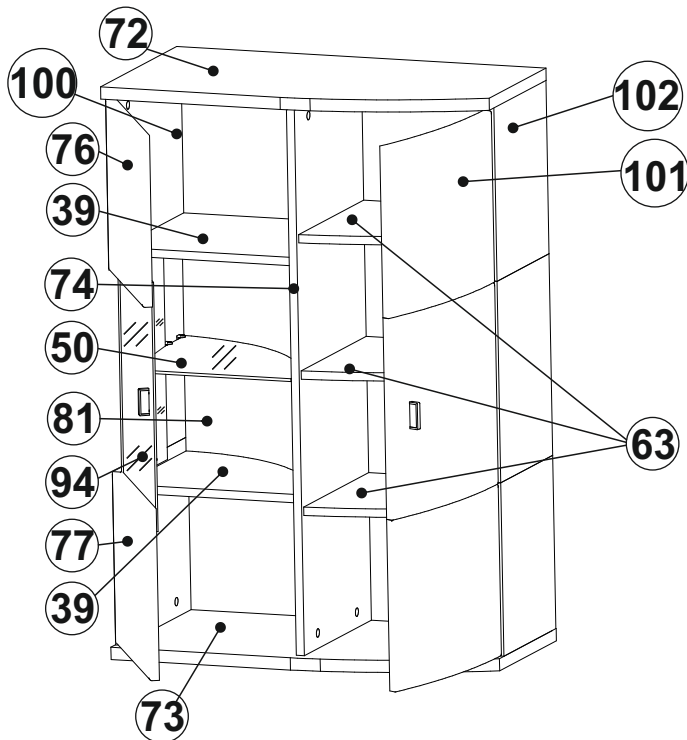

Grund der Beanstandung.....

Name..... Telefon:..... Kunden Nr:.....

Kommissions-AB.-Nr:..... PLZ:..... Ort:.....

Fax:..... E-mail:..... Strasse:..... Haus-Nr:.....