

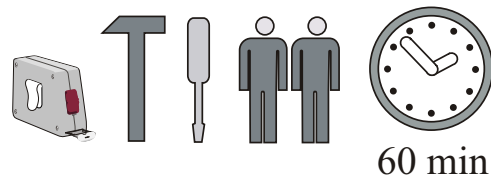

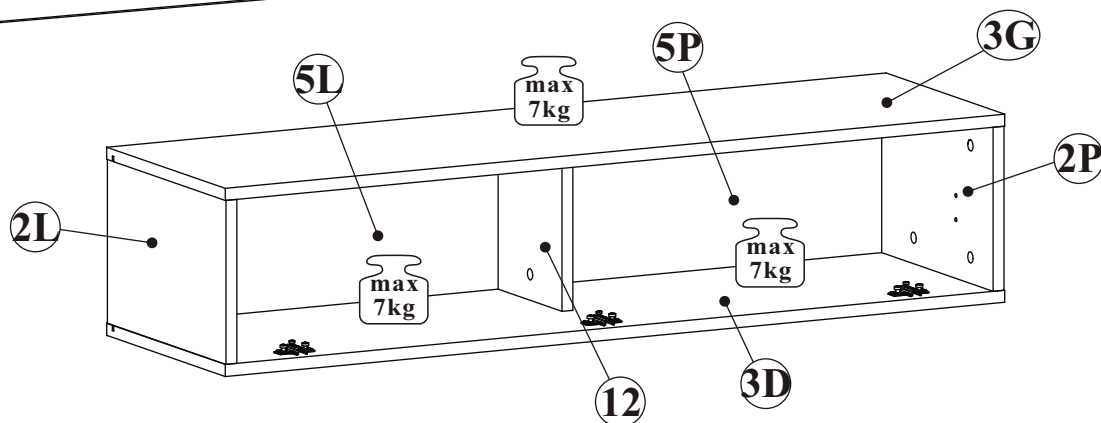

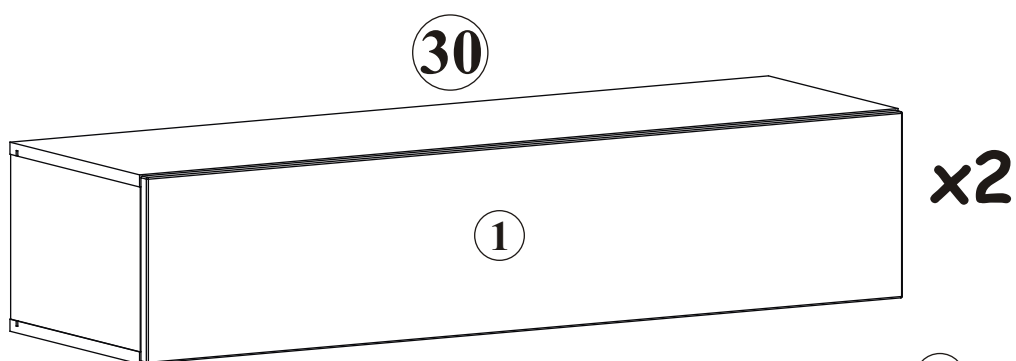

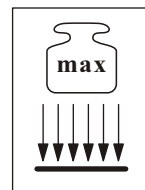

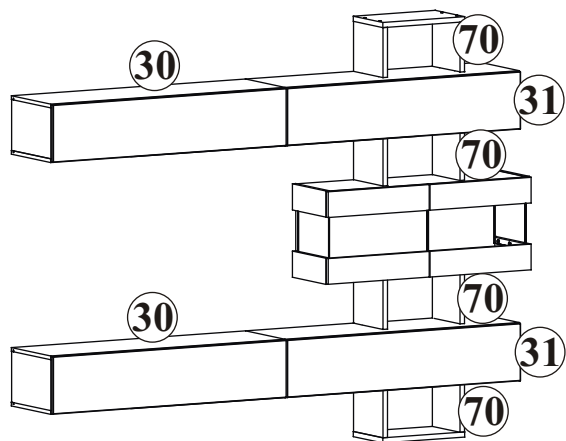
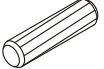
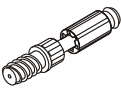
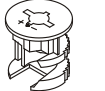

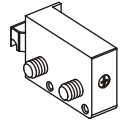
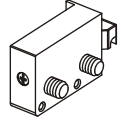
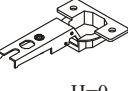
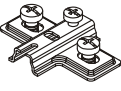
TOKYO 20_TK TYP 30

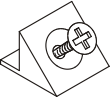
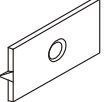

| NO | Dim. | | | Col.-No | Qty |
|----|------|-----|----|---------|-----|
| 1 | 1146 | 246 | 16 | 3/5. | 2 |
| 2L | 218 | 334 | 16 | 1/5. | 2 |
| 2P | 218 | 334 | 16 | 1/5. | 2 |
| 12 | 218 | 180 | 16 | 1/5. | 2 |
| 3D | 1150 | 334 | 16 | 1/5. | 2 |
| 3G | 1150 | 334 | 16 | 1/5. | 2 |
| 5L | 564 | 230 | 3 | 1/5. | 2 |
| 5P | 564 | 230 | 3 | 1/5. | 2 |

TOKYO 20_TK TYP 30

| | | | | | |
|---|--|--|--|--|---|
| A1 x24  ø8x36 | B4 x20  | B5 x20  Ø15x12 | G5 x20  | ZXL x2  | ZXP x2  |
| E1 x6 Ø26  H=0 | E2 x6  H=0 | D10 x24  USØ3,5x13 | OD2 x2  | G21 x4  | D7 x12  USØ3x16 |
| S1 x20  | G16 x4  | UP13 x4  UPØ3x16 | KR3 x4  Ø10 | G2 x1  | |

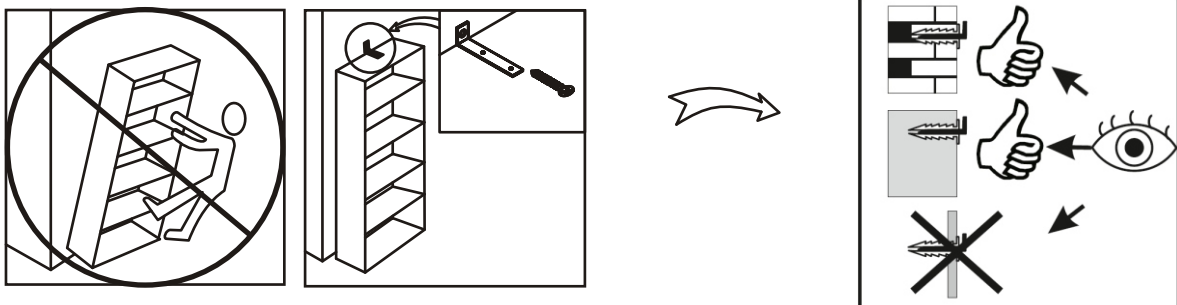
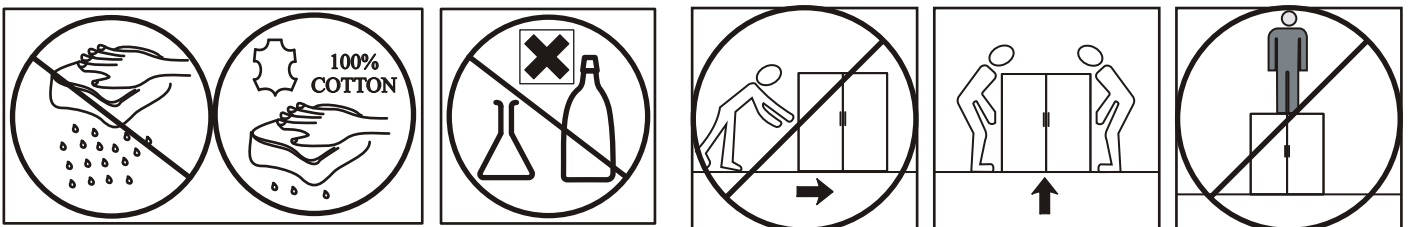
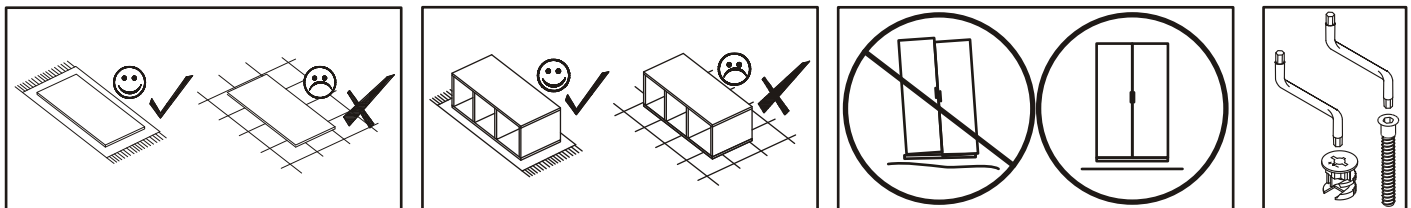
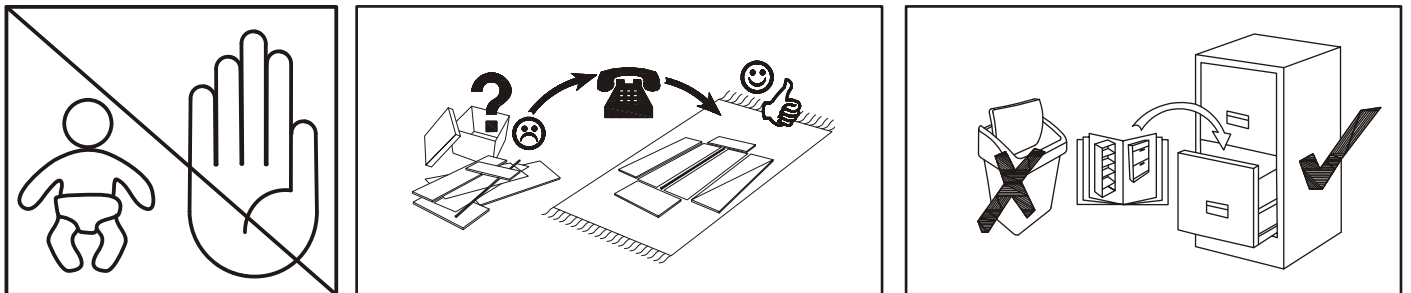
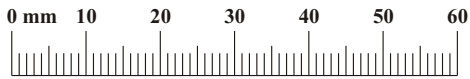

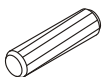
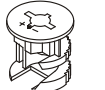
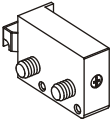
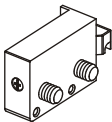
| | | | | | |
|-----|--|-----|--|-----|---|
| A1 |  | B5 |  | ZXL |  |
| x16 | ø8x36 | x16 | Ø15x12 | x2 | |
| | | | | ZXP |  |
| | | | | x2 | |

1

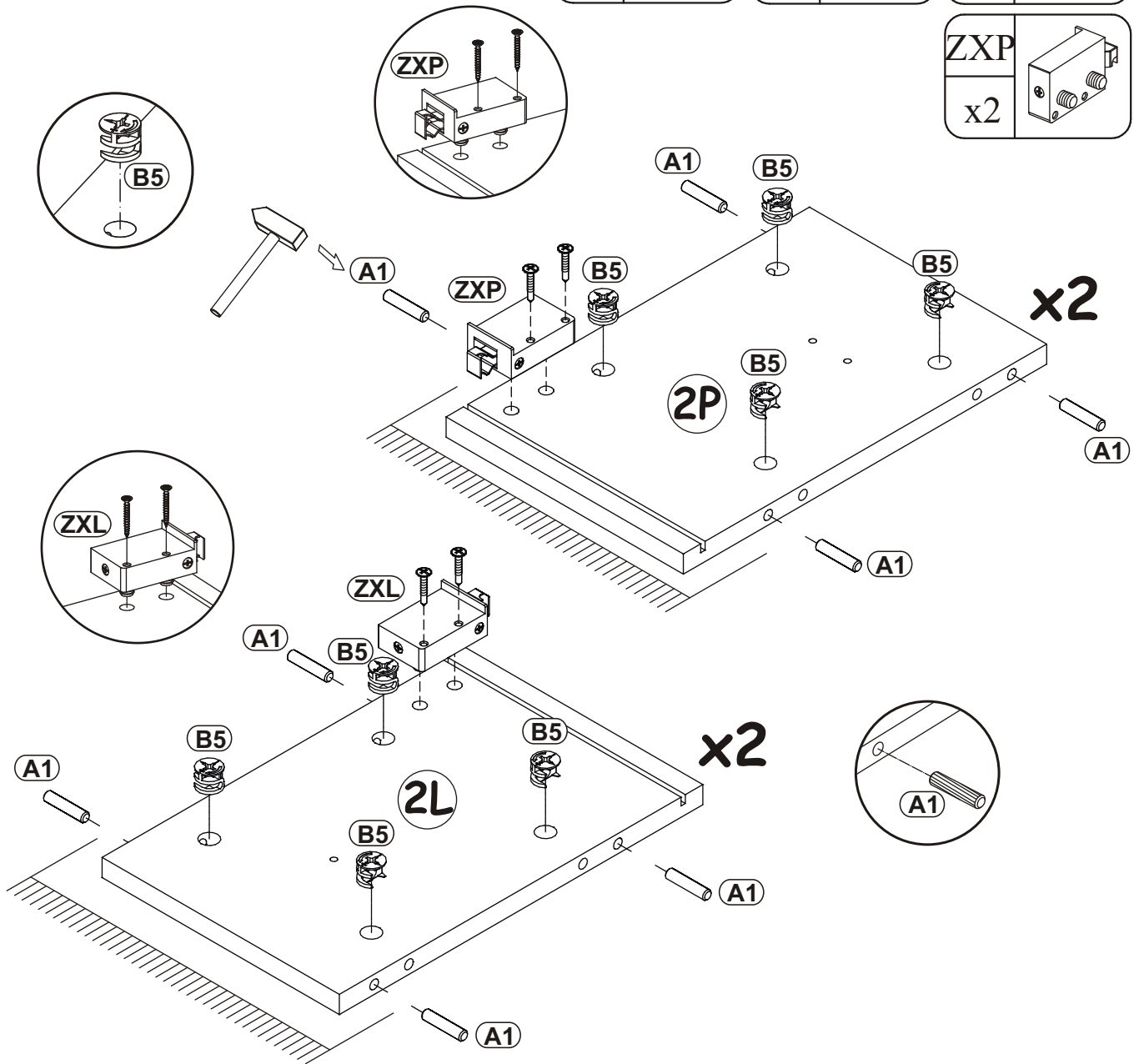

2

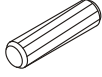
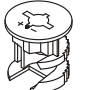
| | | | |
|----|---|----|---|
| A1 |  | B5 |  |
| x8 | ø8x36 | x4 | Ø15x12 |

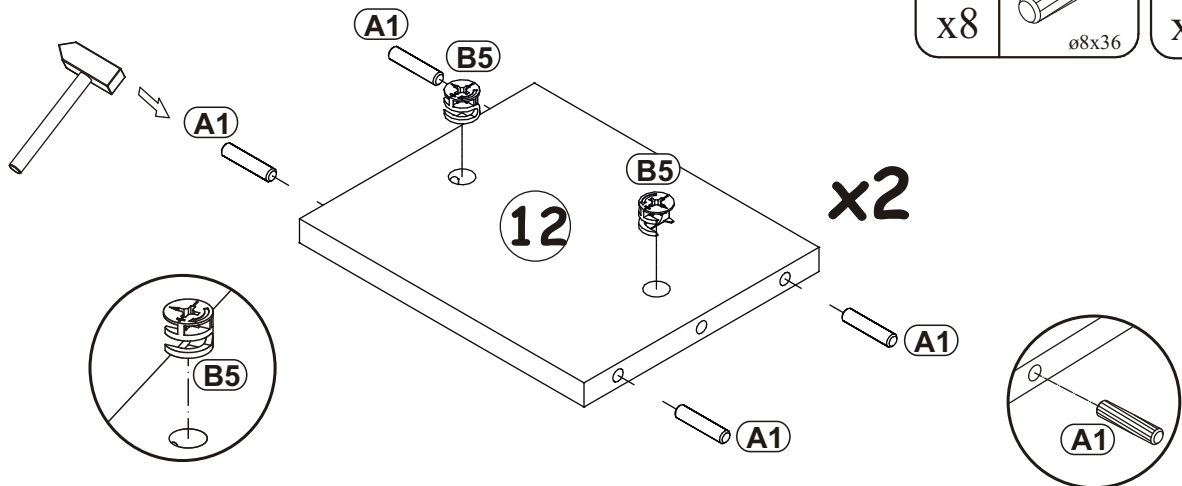

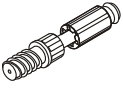
| | |
|-----|---|
| B4 |  |
| x10 | |

3

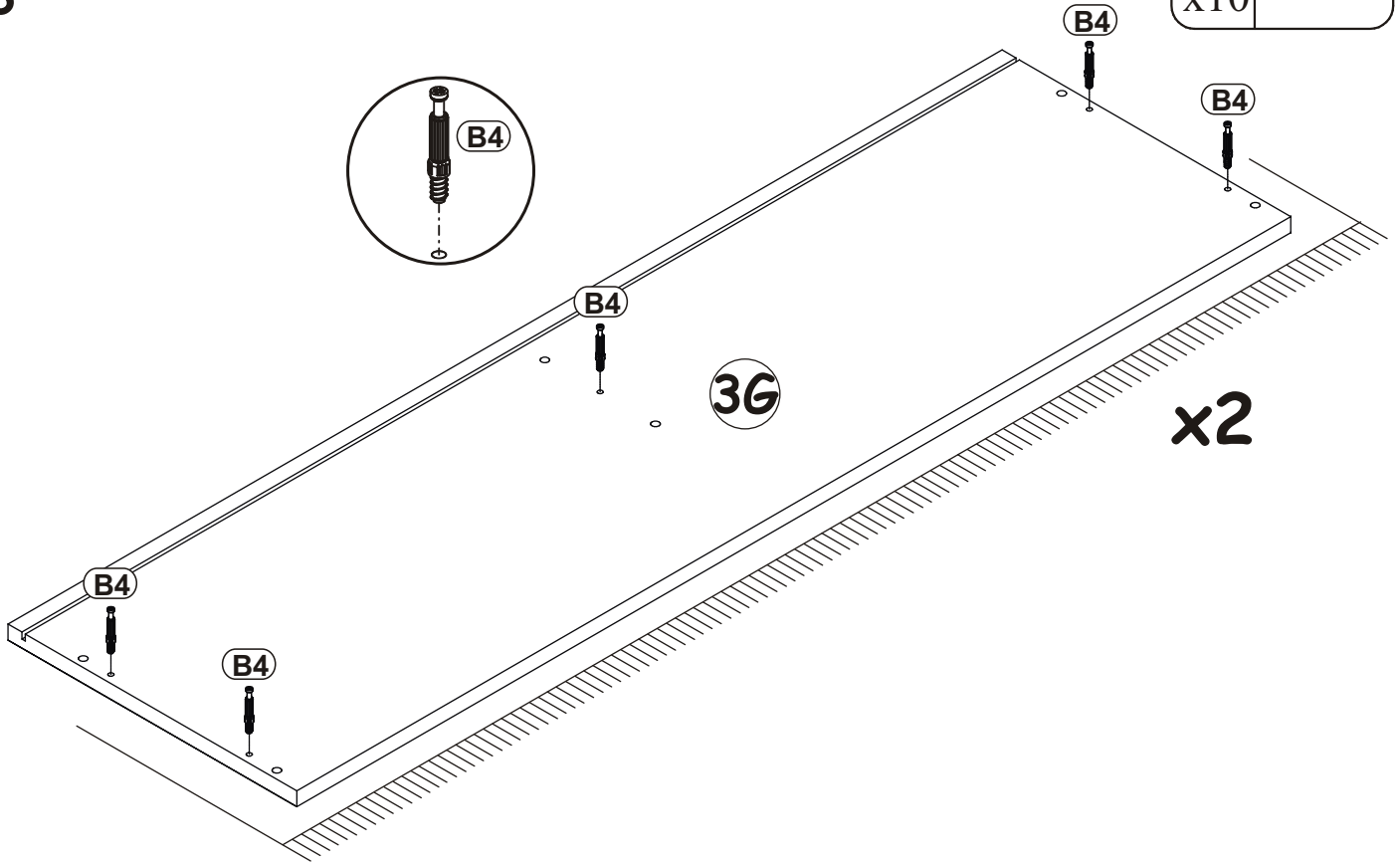

4

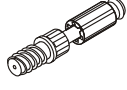
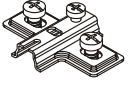
| | | | |
|-----|---|----|---|
| B4 |  | E2 |  |
| x10 | | x6 | H=0 |

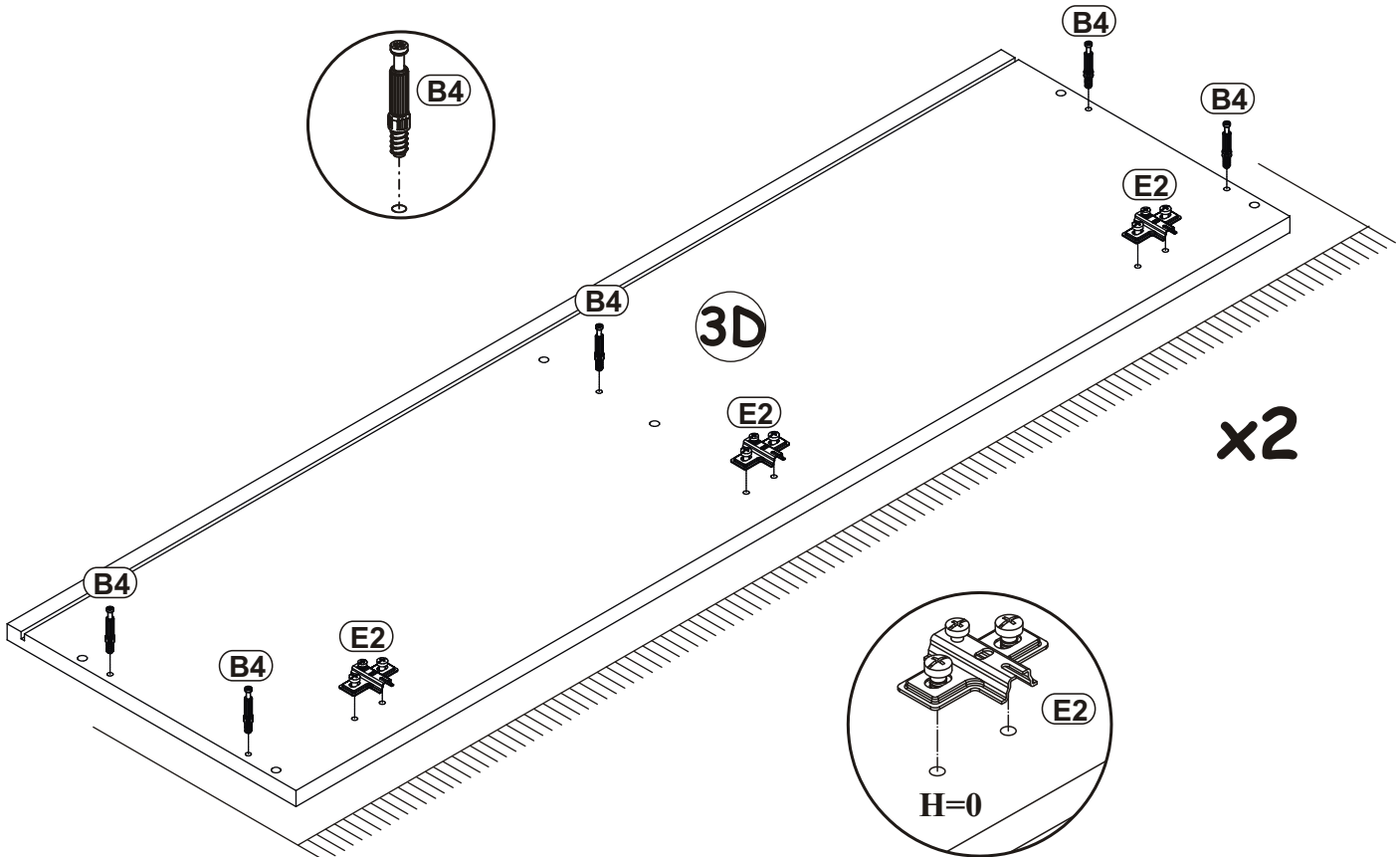

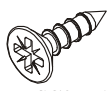
| | | | |
|----|-----|-----|---|
| E1 | Ø26 | D10 |  |
| x6 | H=0 | x12 | |

5

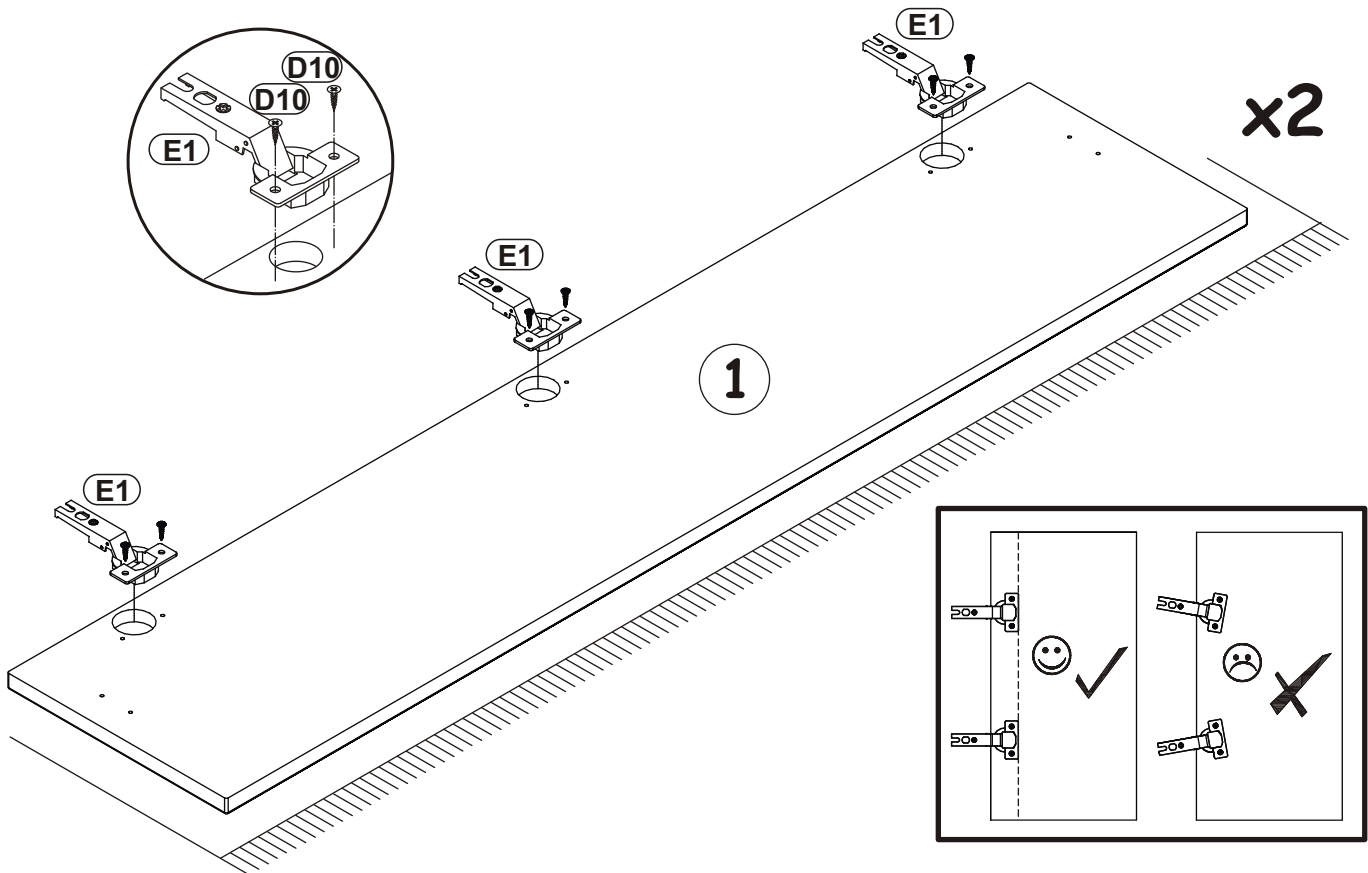

6

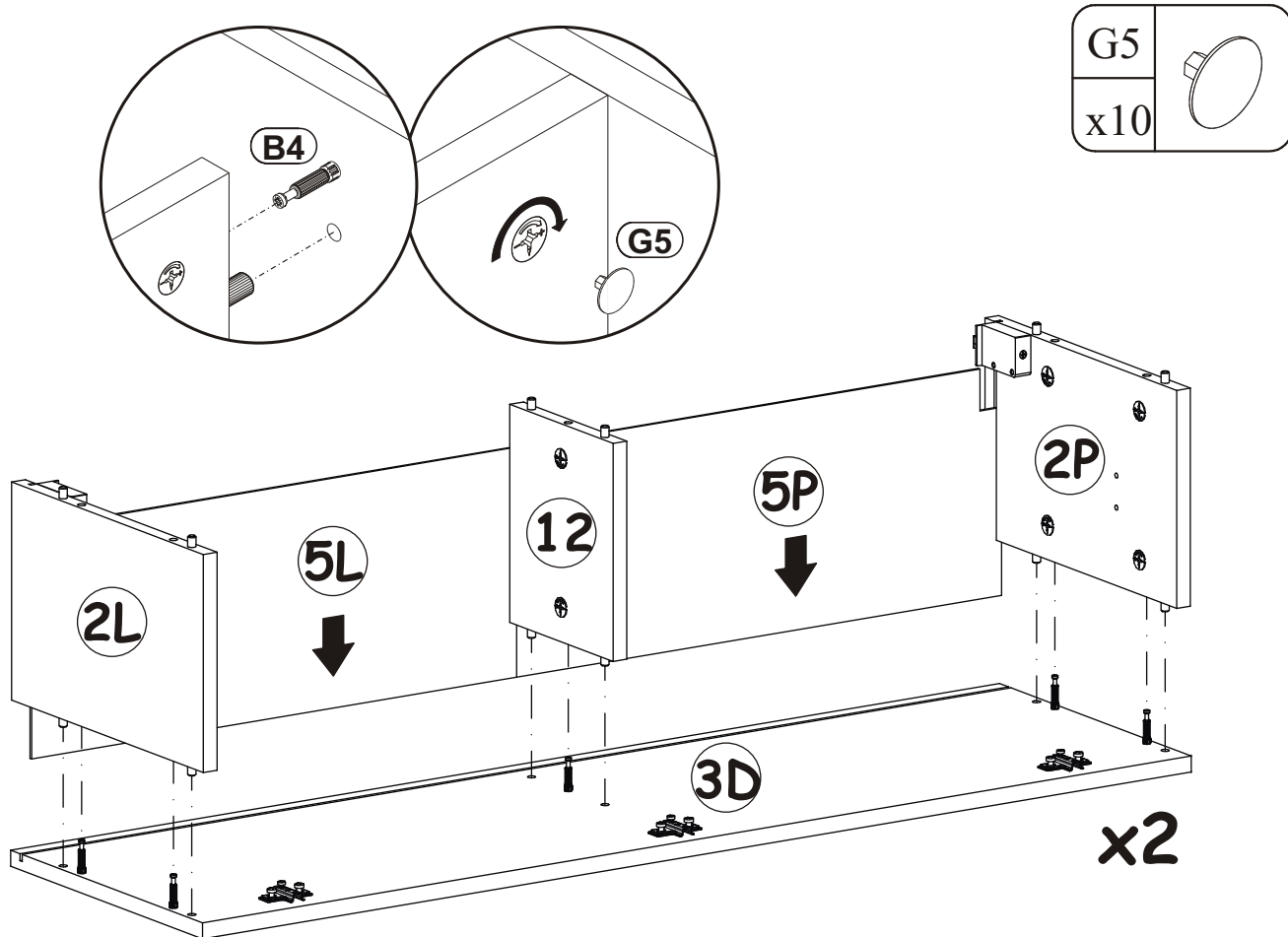

7

| | |
|-----|---|
| G5 |  |
| x10 | |

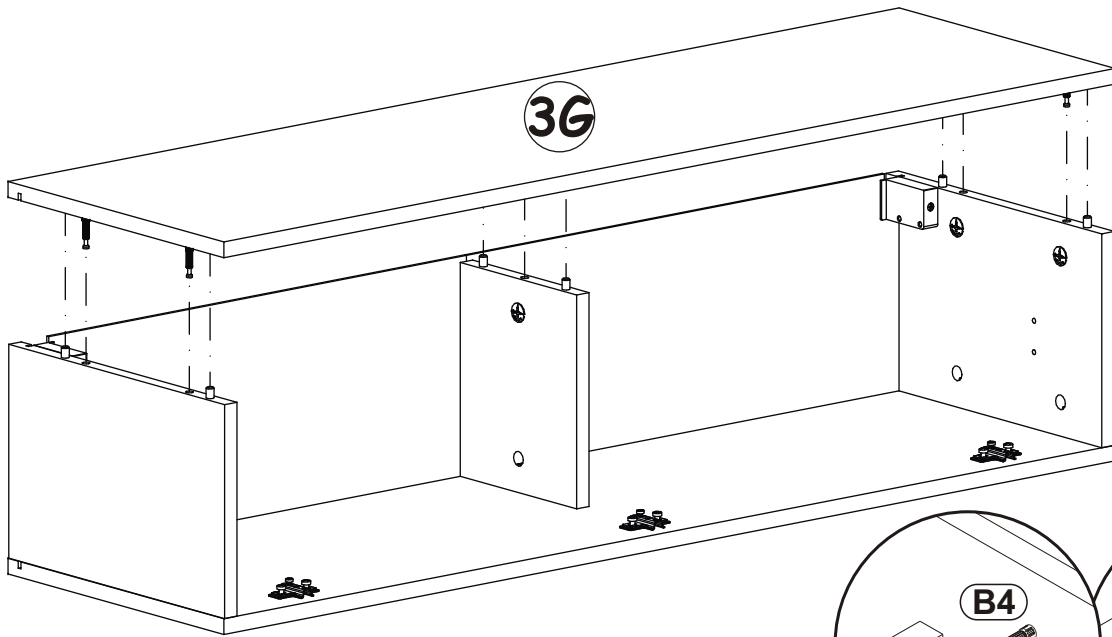

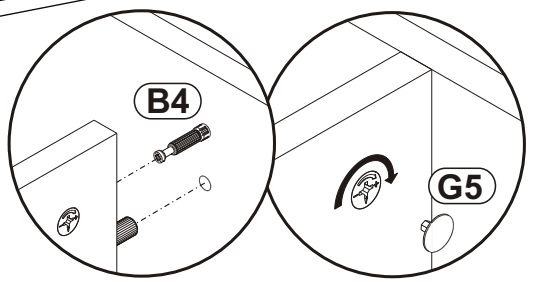

x2



8

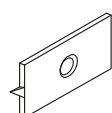

| | |
|-----|--|
| G16 |  |
| x4 | |

| | |
|------|---|
| UP13 |  |
| x4 | UPØ3x16 |

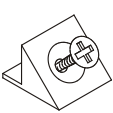

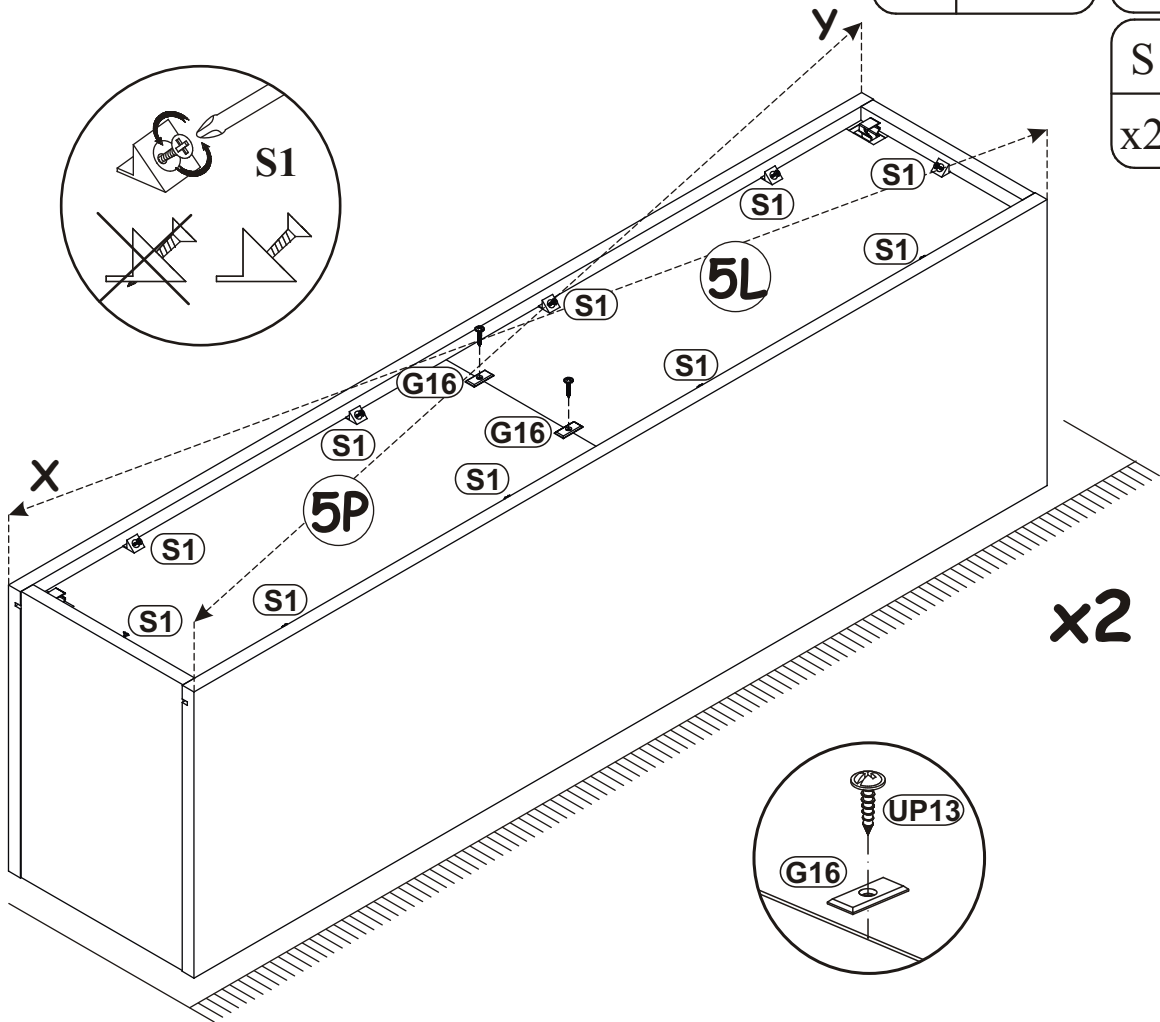
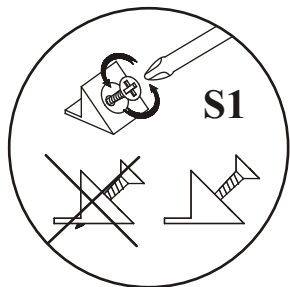
| | |
|-----|---|
| S1 |  |
| x20 | |

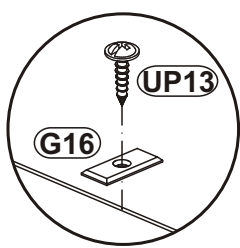

x2



9

| | | | |
|-----|---|-----|---|
| OD2 |  | D10 |  |
| x2 | | x4 | US03,5x13 |

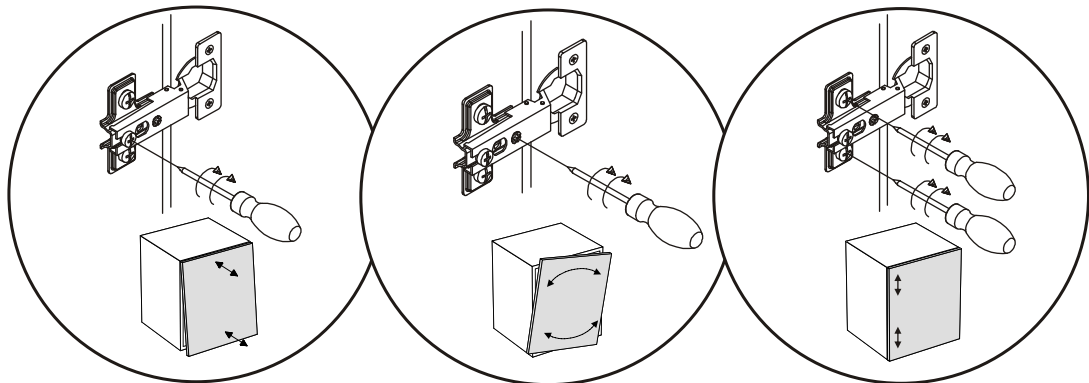
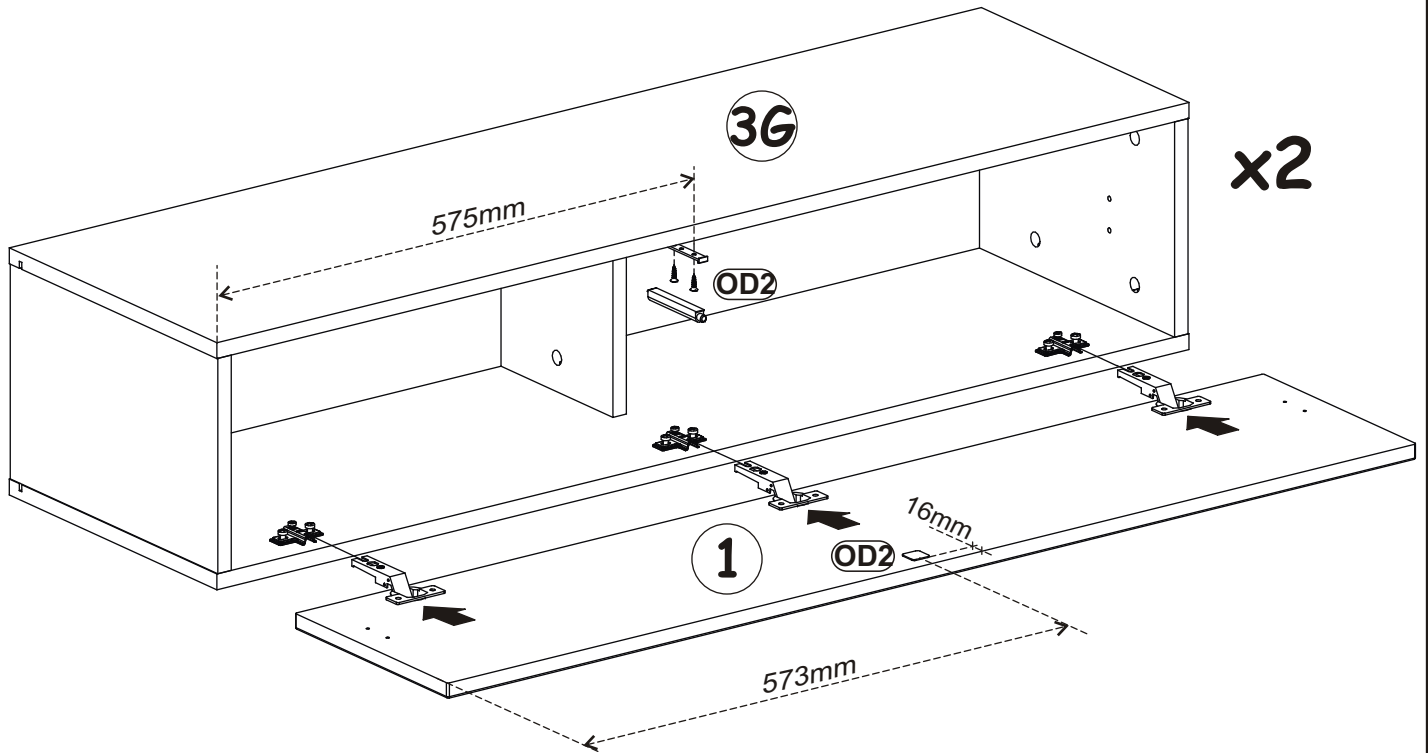
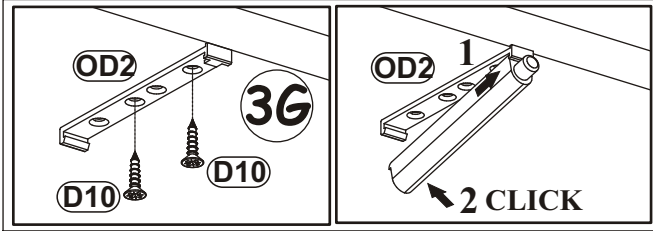

10

