

WindFall® TV STAND

the Modern, Minimal, Mid-Room Media Center

Assembly & Installation

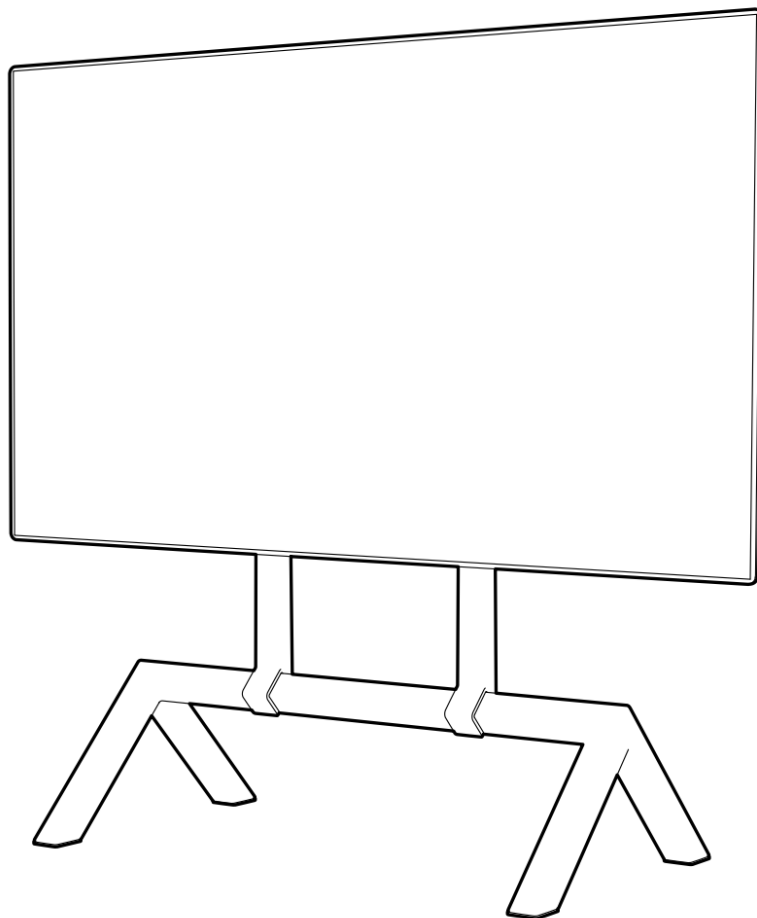

1:1

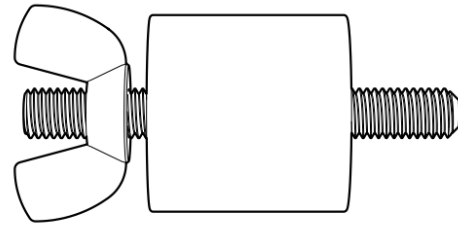
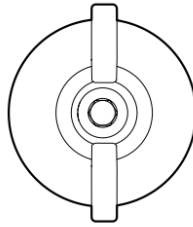
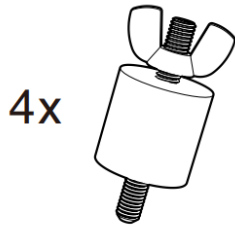

M8 TV Mounting Hardware
F521

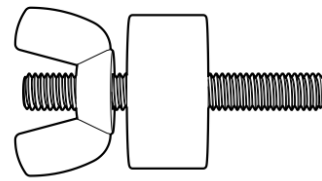
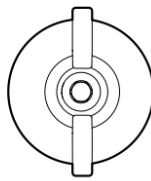
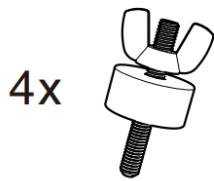

M6 TV Mounting Hardware
F551

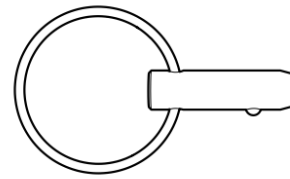
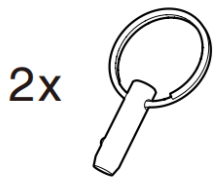

Safety Pin
F492

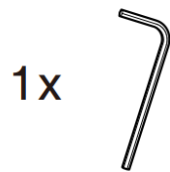

1/8" Hex Key
F180

1 Carefully place TV face down on soft surface

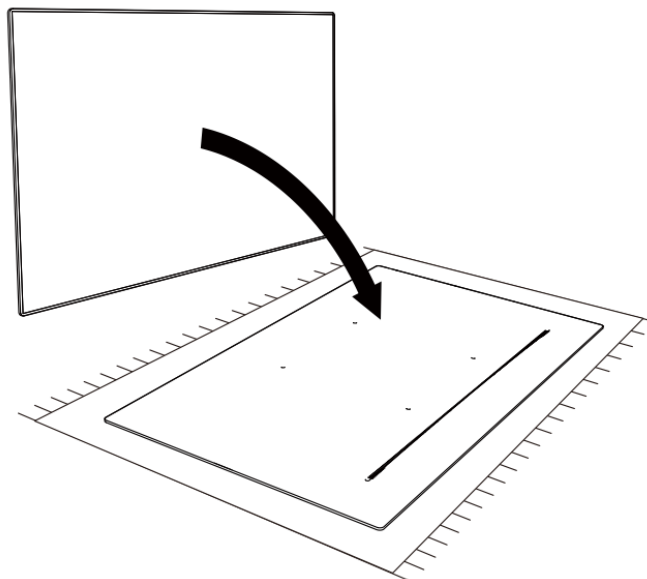

2 Identify your TV's VESA hole pattern

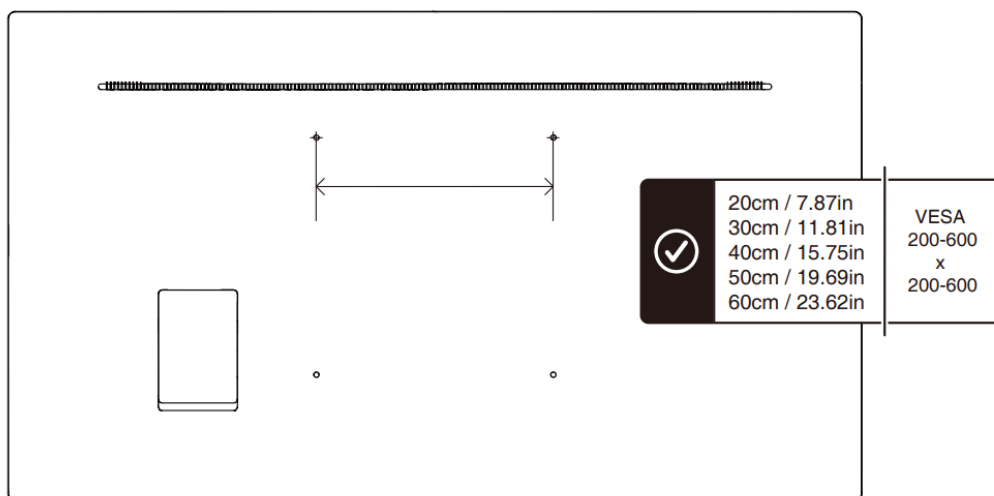

3 Select correct TV-mounting screws

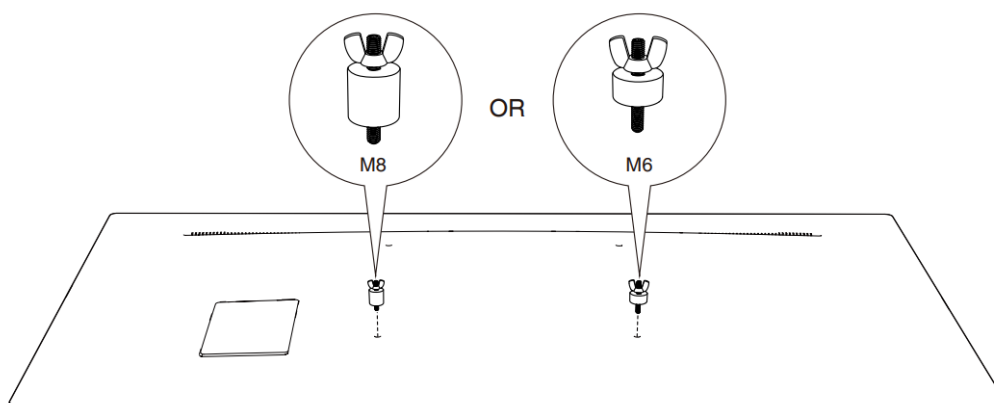

4 Install TV mounting hardware

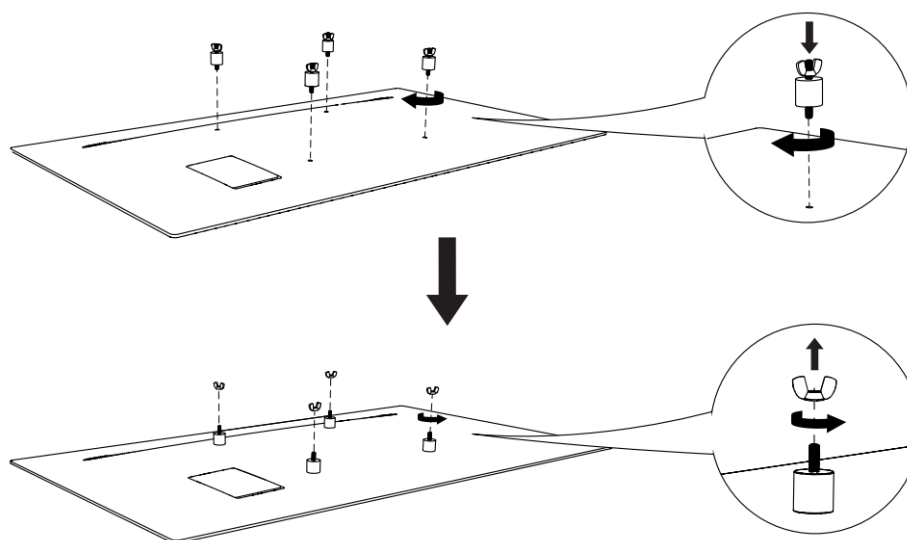

5 Install vertical rails to TV

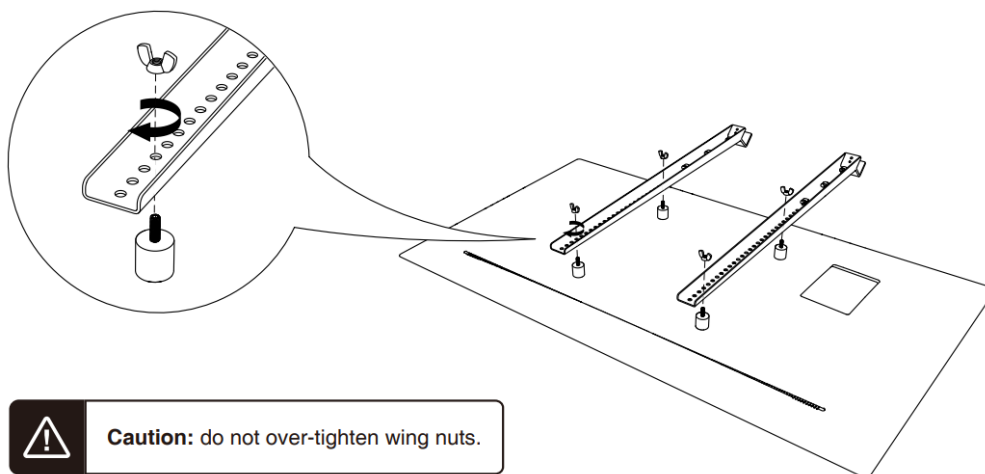

6 Lower TV onto base

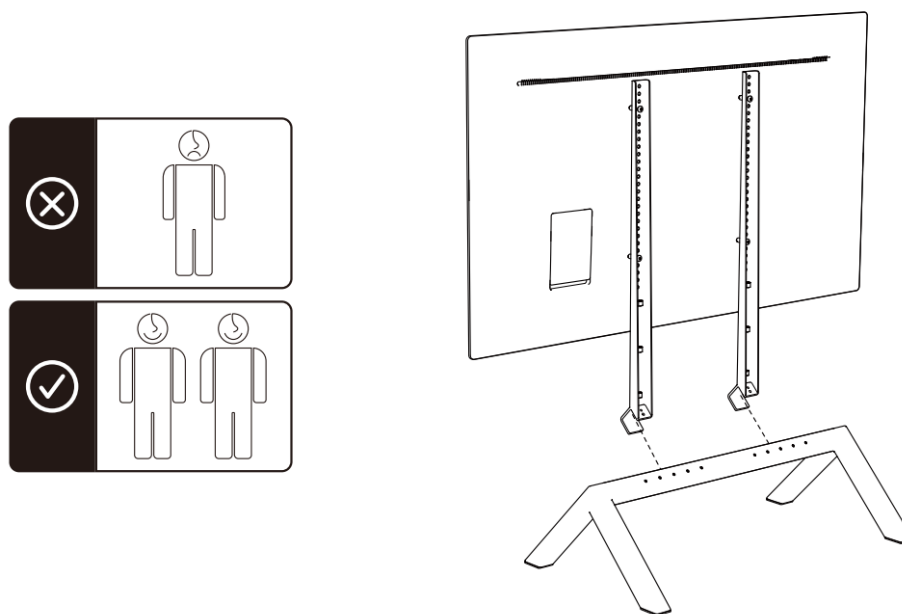

7 Insert safety pins and tighten set screws

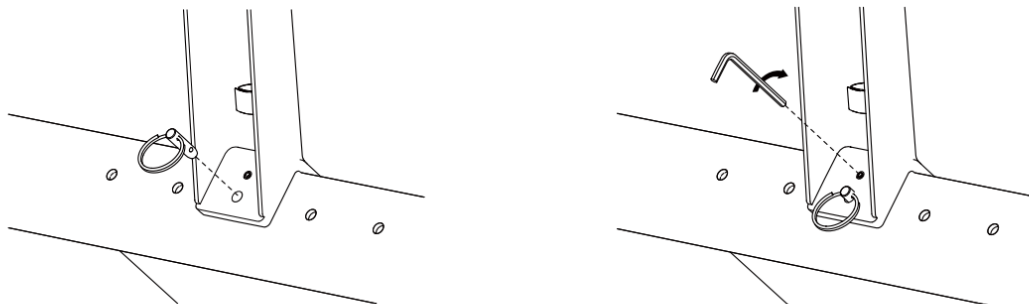
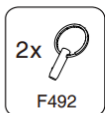

 **Important:** Insert pins and tighten set screws fully to secure TV

8 Use cable straps to channel power cables

