

A PERSONAL MESSAGE FROM OUR FOUNDER

When I shop, I am not just buying a product or service. I purchase why that brand focuses on what they do, what their corporate philosophy is, the quality of their products, and whether or not my personal core values align with that brand's vision. When I don't feel great about a company's brand, products, or how I'm being treated as a customer, then I know they are not delivering on what matters most: exceeding the customer expectation by delivering happiness with their products, quality, and service.

This primary focus is what drives our culture at Team Skybound. For supporting our vision, we would like to personally thank you for trusting us to deliver happiness to you and your family!

-Kiki (Founder) & Team SkyBound

"Nurturing the inner-child in all of us by uniting communities worldwide and promoting an active lifestyle."

For customer service, please contact:

888-891-4689

Monday through Friday

8:00 am to 5:00 pm PST

or visit www.SkyBoundUSA.com

or www.TrampolinePartsCenter.com



help@skyboundusa.com



TRAMPOLINE BASKETBALL HOOP

ASSEMBLY AND INSTALLATION MANUAL

www.SkyBoundUSA.com

www.TrampolinePartsCenter.com

ASSEMBLY INSTRUCTIONS

ACCESSORIES LIST 1

Warning: Read this manual prior to assembly for important safety information user age:5+

Warning: Improper installation or swinging on the ring may cause serious injury or death.





Assembly Tip: The basketball set work for most kinds of trampoline pole, like round pole, oval pole, pole in enclosure net. Recommend pole's diameter: 25mm-32mm.

Warning: Minimize excessive jumping near the trampoline mat edge, as this will accelerate wear and tear on the mat edge, pad, and springs.

Warning: Pump needle is in the pump handle. Keep it away from kids.



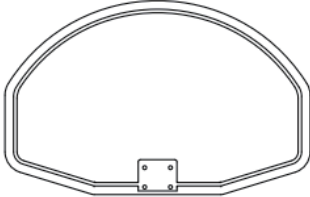









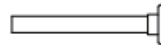

Warning: 365 day manufacturer warranty after purchase.

This object is subject to wear and tear. No warranties whether expressed or implied are provided. Injury will likely occur with the use of a trampoline or any associated product. Use with supervision. Use at your own risk. Only Use in a well-lit, well secured down area.

NO.	Part Name	Pictures	Quantity
1	Basketball Hoop		1
2	Basketball Frame Net		1
3	Backboard		1
4	L-Arm		1

ASSEMBLY INSTRUCTIONS

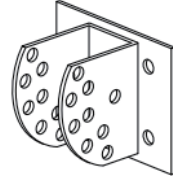
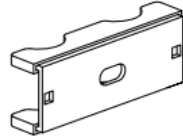
ACCESSORIES LIST 2

NO.	Part Name	Pictures	Quantity
A	Nut Wrench		1
B	L Wrench		1
C	Round Head Screw (M8*30mm)		4
D	Round Head Screw (M8*45mm)		1
E	Carriage Bolts (M6*70mm)		2
F	Carriage Bolts (M10*90mm)		1
G	Lock Nut (M8)		5
H	Lock Nut (M6)		2
I	Washer (M8)		5
J	Washer (M6)		2
K	Washer (M10)		1
L	Bolt		1
M	Plum Knob		1
N	Angle Adjusting Plate		1
O	Clamp		2
P	Plastic Screw Cap		1

ASSEMBLY INSTRUCTIONS

TRAMPOLINE BASKETBALL SET SAFETY INFORMATION & INSTALLATION INSTRUCTIONS

STEP 1

Attach Part 1 to Part 2 as shown in the figure

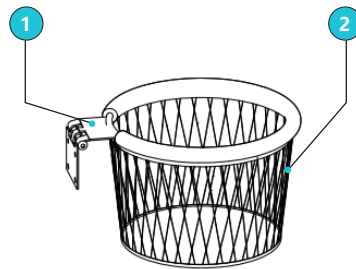

STEP 2

As shown in the following figure. Connect Part 1 to part 3. Insert Part C to the connected Parts 1 and 3. Use L wrench (Part B) to tighten screw Part C. Connect Part N to the back of Part 3. The following washers, Parts G and I will be screwed on to the bolts (Part C). Tighten washers (Part G,I) with wrench (Part A)

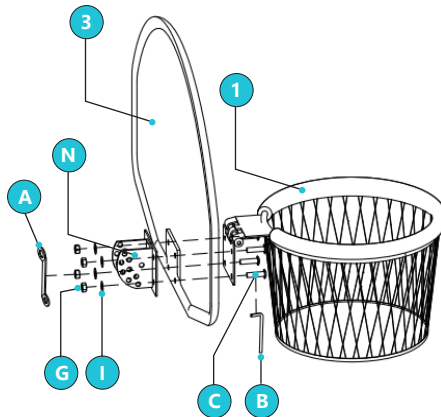

ASSEMBLY INSTRUCTIONS

TRAMPOLINE BASKETBALL SET SAFETY INFORMATION & INSTALLATION INSTRUCTIONS

STEP 3

Insert Part D to connected Part N and Part 4.

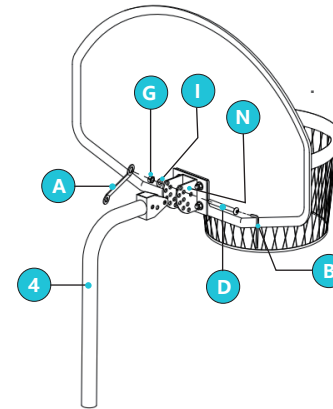

STEP 4

Adjust the bolt Part L to desired angle use Part B

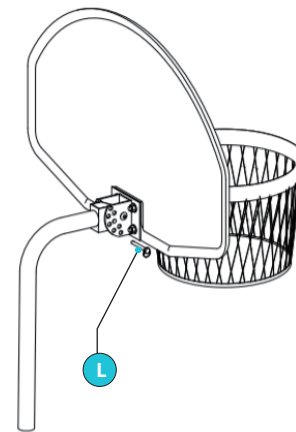

ASSEMBLY INSTRUCTIONS

TRAMPOLINE BASKETBALL SET SAFETY INFORMATION & INSTALLATION INSTRUCTIONS

STEP 5

Use Part E, F and H and Part O to assemble with the net guard of the trampoline according to good step 4. Part M is used between Part F and Part K. Part J is used between Part E and Part H; Use the Part A to complete the installation. As shown in the following figure.

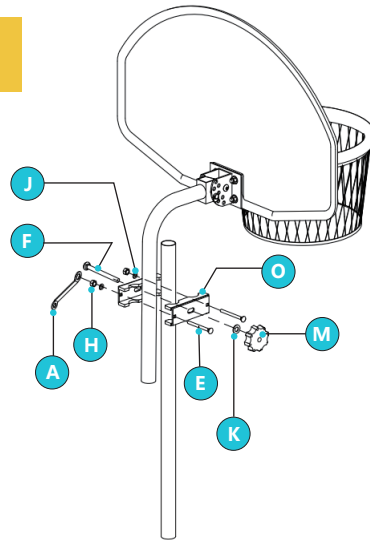

STEP 6

Install plastic screw cap Part P onto carriage bolt Part E.

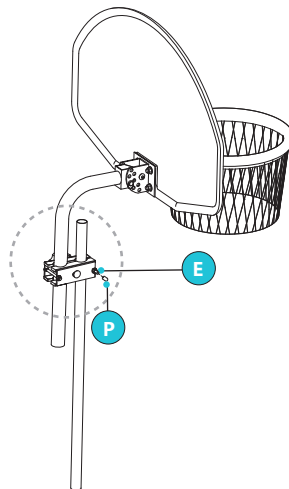

ASSEMBLY INSTRUCTIONS

TRAMPOLINE BASKETBALL SET SAFETY INFORMATION & INSTALLATION INSTRUCTIONS

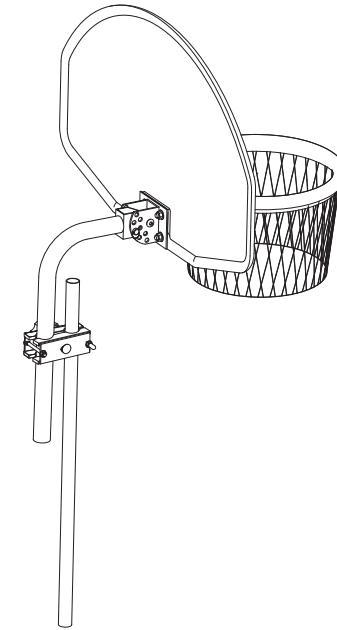

Installation completion drawing

SkyBoundUSA.com

(888) 891-4689

SkyBound Customer Service
help@skyboundusa.com



SkyBound, a BX International Inc Company.
SkyBound is a registered trademark of BX International Inc.
in the U.S. and other countries. All logos, names,
characters, likenesses, images, slogans and
packaging appearance are the property of SkyBound.