

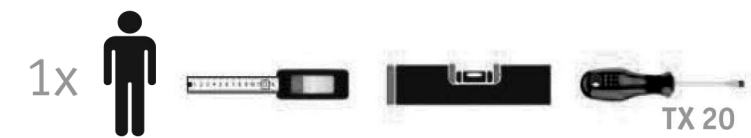

Pullboy Z Blum



Einbau- Abfallsammler / Built-in waste bin

1

Eimerhöhe mm Bin height mm	min. Y mm
260	225
295	260
460	425
495	460
430	395
530	495

2

3

Die Pflege und Reinigung kann mit handelsüblichen Reinigungsmitteln erfolgen.

The waste bin can be cleaned with commercial household cleaner.

La poubelle peut être nettoyée avec produits des nettoyage usuels.

El cubo de basura se puede limpiar con limpiador domestico comercial.

Onderhoud en reiniging met normale spoelmidelen voor huishoudelijk gebruik.

Box systems

blum

- ▶ TANDEMBOX antaro
- ▶▶ Standard cabinet



Drawer – M

Webcode
DQC2QM



- Concealed, guided full extension – unsurpassed running action – for the lifetime of the furniture
- Steel drawer side and stainless steel
- Tool-free front assembly
- 2-dimensional front adjustment
- Includes integrated **BLUMOTION** for silent and effortless closing action, can be combined with **SERVO-DRIVE**
- Or with an integrated **TIP-ON** function for handle-less fronts

Space requirement

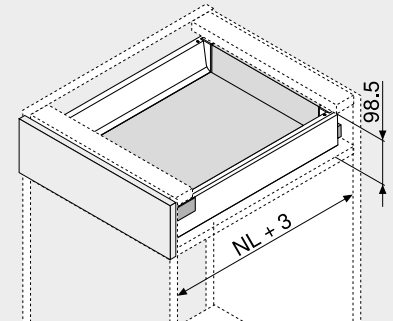

NL | Nominal length

Order information

1	Cabinet profiles left/right		2	Left/right drawer sides	
Nominal length	Dyn. carrying capacity (kg)		Nominal length	Colour	
NL (mm)	30	65	NL (mm)	SW TS R9006	INGL
270	578.2701B		270	378M2702SA	378M2702IA
300	578.3001B		300	378M3002SA	378M3002IA
350	578.3501B		350	378M3502SA	378M3502IA
400	578.4001B		400	378M4002SA	378M4002IA
450	578.4501B	576.4501B	450	378M4502SA	378M4502IA
500	578.5001B	576.5001B	500	378M5002SA	378M5002IA
550	578.5501B	576.5501B	550	378M5502SA	378M5502IA
600	578.6001B	576.6001B	600	378M6002SA	378M6002IA
650		576.6501B	650	378M6502SA	378M6502IA

For the order specification for TIP-ON, see motion technologies section

Incl. cover caps (Can be individually printed – minimum order quantity 1000 items)

3	Back fixing left/right		
Colour	Material	Part no.	
SW TS R9006 NI	Steel	Z30M000S.04	

4	Front fixing bracket		
Fixing method	Part no.		
INSERTA	2 x	ZSF.3902	
Screw-on	2 x	ZSF.3502	
Knock-in	2 x	ZSF.3602	

Colour		Colour	
SW	Silk white	WGR	White grey
TS	Terra black	R7037	RAL 7037 dust grey
R9006	RAL 9006 grey (white aluminium)	NI	Nickel plated
INGL	Stainless steel (Inox) Anti-fingerprint	NI-M	Matt nickel
S	Black		

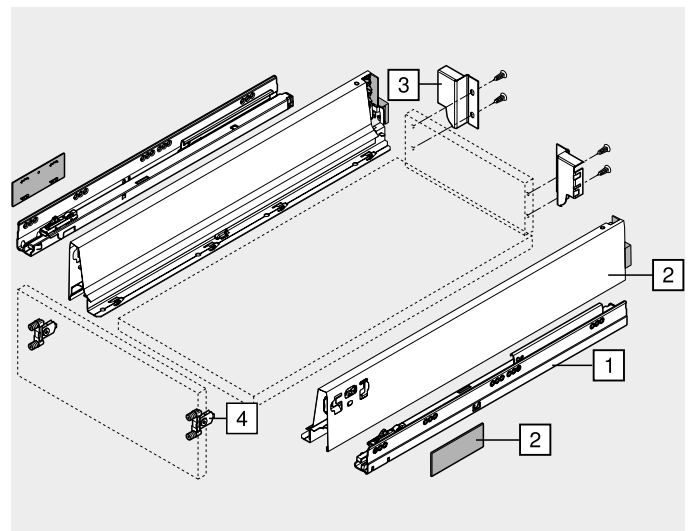

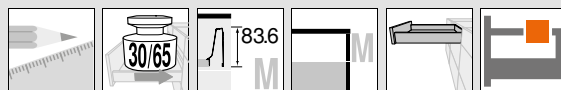

Drawer – M

Webcode
DQC2QM

Planning

Space requirement in cabinet	Installation dimensions – front – screw-on	Drilling distances – front – INSERTA/knock-in	Installation dimensions – back

FA Front overlay

Screw position – cabinet profiles

Nominal length NL (mm)

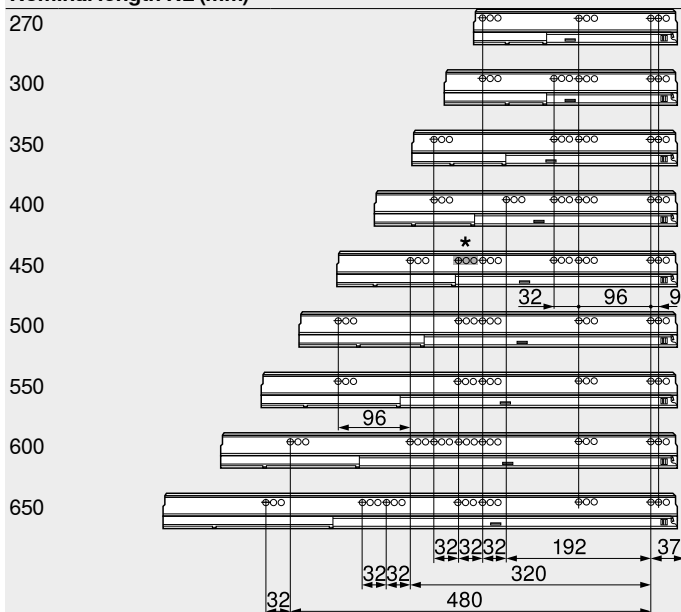

Internal cabinet depth LT min. = nominal length NL + 3 mm
* Only for 578.4501B (30 kg)

Cutting – 16 mm chipboard

B	Back	84 mm							
LW – 87 mm									
A	Base	Chipboard back NL – 24 mm Steel back NL – 22 mm	<table border="1"> <tr> <td>KB</td> <td>Cabinet width</td> </tr> <tr> <td>LW</td> <td>Internal cabinet width</td> </tr> <tr> <td>NL</td> <td>Nominal length</td> </tr> </table>	KB	Cabinet width	LW	Internal cabinet width	NL	Nominal length
KB	Cabinet width								
LW	Internal cabinet width								
NL	Nominal length								
LW – 75 mm									

Page instructions

Overview – TANDEMBOX antaro	303	Accessories	342
Overview – SERVO-DRIVE for LEGRABOX/TANDEMBOX	555	Cabinet profile fixing positions	350
TIP-ON for TANDEMBOX	664	Assembly, removal and adjustment	352
Overview – ORGA-LINE for TANDEMBOX	509	Overview – assembly devices	683
Accessories – steel back	344	More technical details	774



Drawer

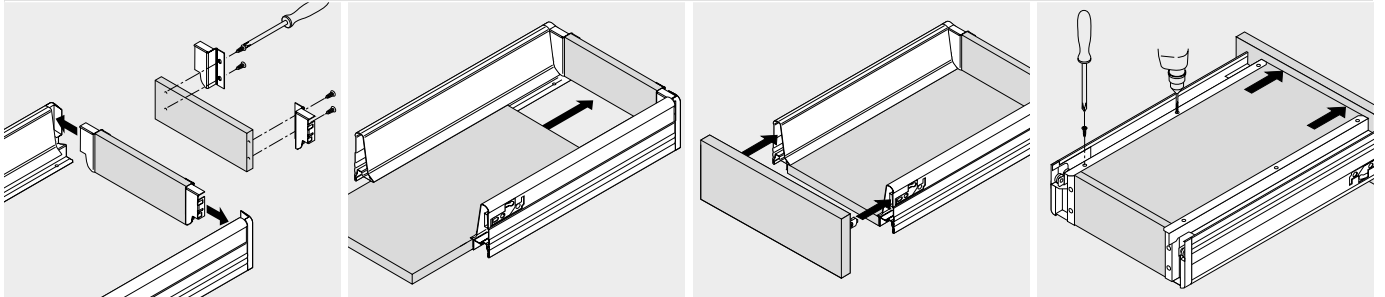

Assembly

Drawer

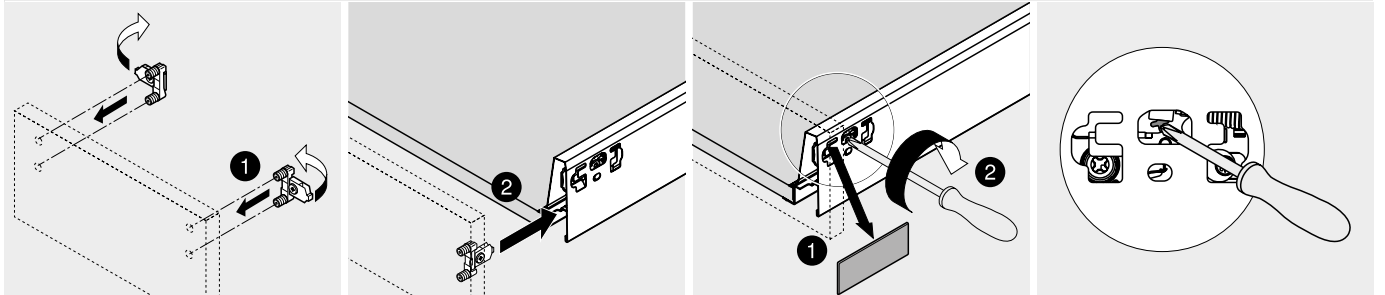

Assembly

Removal

Adjustment

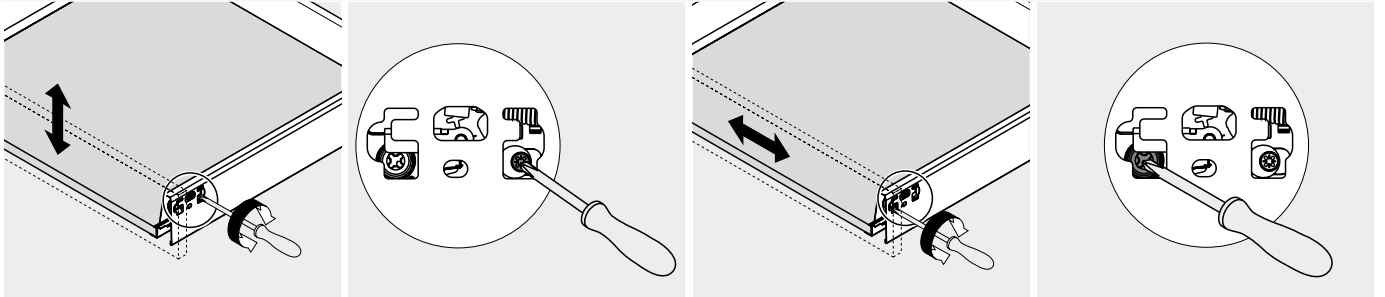

Height adjustment

Side adjustment

Adjustment

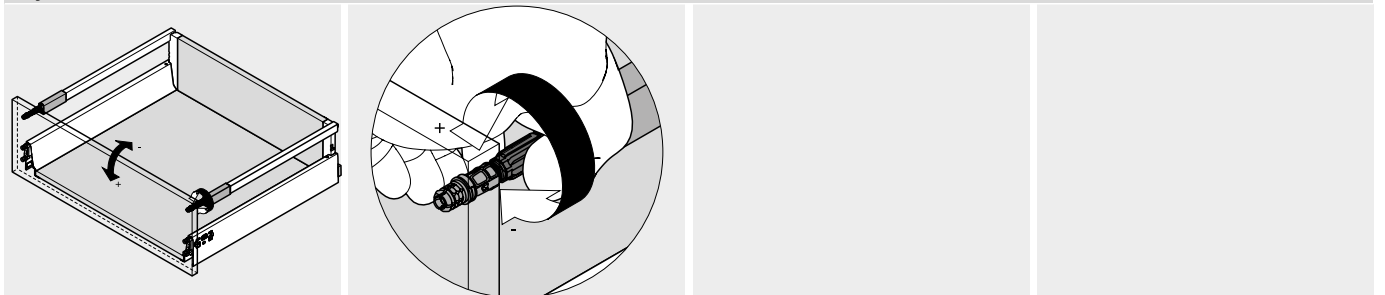

Tilt adjustment

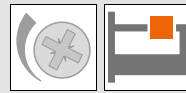

Drawer insertion and removal

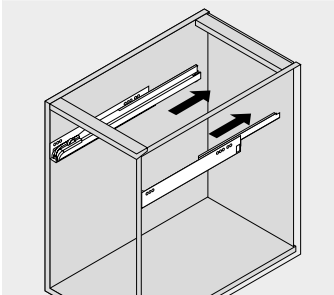

Insertion

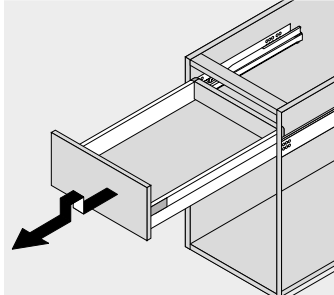
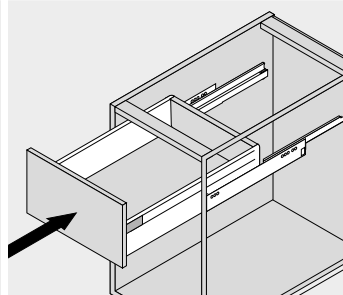

Removal

Inner drawer

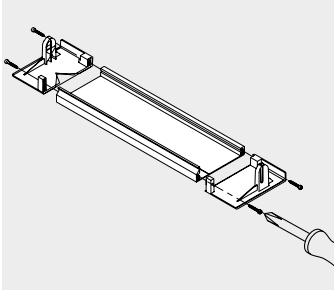

Assembly

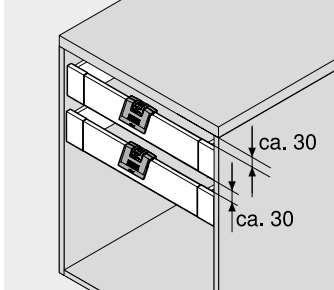
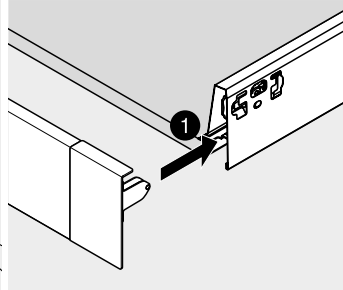

30 mm dimension can be reduced if
 ZIF.80M5 handle is utilised

Locking piece – Z31A0008

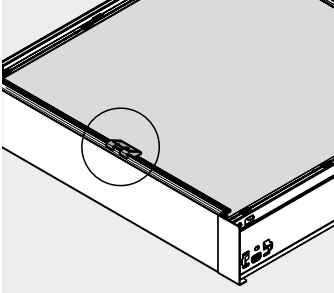

Starting with cabinet width KB
 600 mm

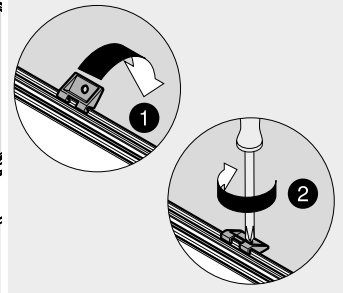

Inner drawer

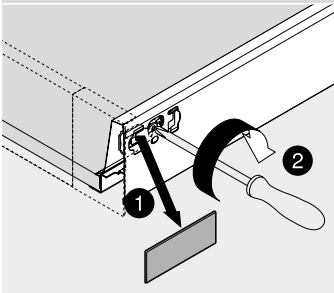

Removal

