

# HANG IT PERFECT

FIRST TIME • EVERY TIME

1. CROSSBAR WITH RULER (IN. & CM)
2. ARM WITH RULER (IN. & CM)
3. KNOB
4. HOOK & PIN
5. LEVEL (ON BACKSIDE OF TOOL)

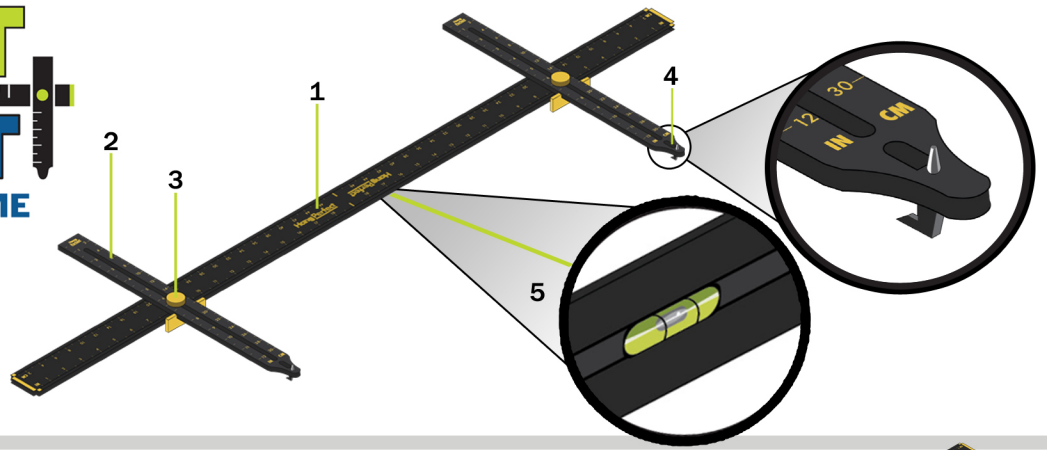

## ASSEMBLY

- A. Remove Hang It Perfect from the box.
- B. Slide arms onto crossbar.
- C. Gently Tighten knobs to hold arms on crossbar, yet still able to slide.
- D. Hang It Perfect is now ready to use!

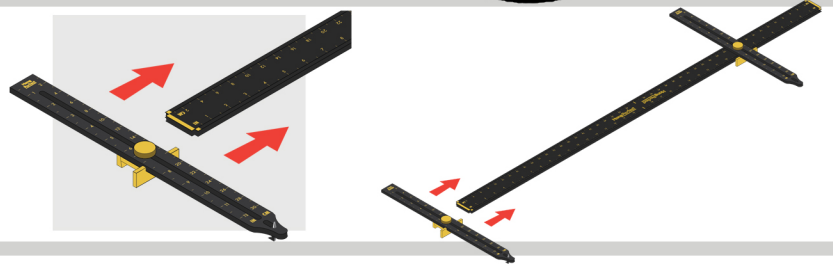

## GETTING STARTED

- A. These instructions are for a mirror with 2 hanging mounts.



- B. Decide where on the wall to hang the mirror. With a pencil, mark on the wall where you want the top & center of the mirror to be.
- C. Determine the center of the mirror and mark it with a pencil.

## STEP 1. ALIGN

- A. Place mirror face down on a flat surface.
- B. Position the crossbar against the top of the mirror.
- C. Align the center mark of the crossbar with the center of the mirror.
- D. Slide arms down to slip into mirror hardware.
- E. Tighten knobs to secure arms in place.

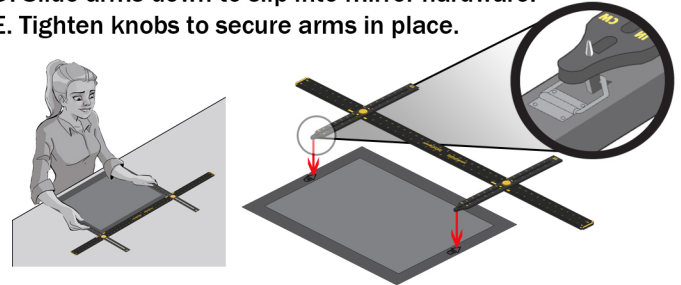

## STEP 2. LEVEL

- A. Remove Hang It Perfect from mirror.
- B. Place Hang It Perfect with knobs against the wall and level facing you.
- C. Align the center of the level with the top-center mark you made on the wall from step one.
- D. Use the level to make sure the crossbar is straight.

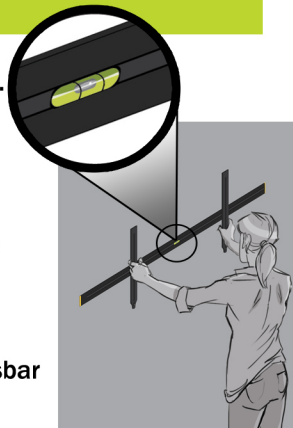

## STEP 3. MARK

- A. Firmly press the hook so that the pin creates a dimple on the wall.

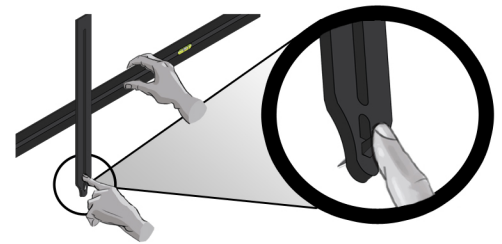

- B. Install wall hardware.

### NAILS

install nail directly into dimple mark

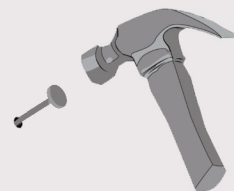

### HANGERS

place hanger base atop dimple mark and install

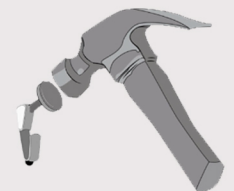

## STEP 4. HANG

- A. Hang the mirror on the installed wall hardware and enjoy!

