

餌やり名人17DX 17LS-DSF

Feeding Master 17DX

Instruction Manual



Caution

Be sure to read through to fully understand the proper operation, handling and inspection for safe use.

CONTENTS

[1]	For Safe Operation-----	1
	1. Introduction	2. Definition of Symbols
	3. Symbols and Parts Names	4. Safety Concerns
[2]	Installation-----	7
	1. Setting of Main Unit	2. Installing of Anchor Plate
	3. Battery Connection	
[3]	How to Operate-----	8
	1. Feeding	2. Current Time Setting
	3. Feeding Timer Setting	4. Spread Range Setting
	5. Test Mode	6. Stop Setting
	7. Instructions for Use	
[4]	Handling of Solar Panel-----	13
[5]	Handling of Battery-----	13
[6]	Protective Function-----	14
[7]	Tank Cleaning-----	14
[8]	Maintenance and Inspection-----	14
	1. Motor Units	
[9]	Specifications-----	14
[10]	Troubleshooting-----	15
[11]	Standard Gross Discharging Amount of Feed-----	16

[1] For Safe Operation

1. Introduction

Thank you very much for purchasing our Feeding Master (17LS-DS).

This Feeding Master can fully sustain under the severe environment and contributes to the feeding efficiency.

This manual describes the proper handling method of Feeding Master long term and safe operation. Be sure to read through this manual before use to fully understand the safe usage and proper handling, and make efforts to safety operation.

After reading, be sure to keep this manual where users can refer to easily to help a long time use.

In addition, please previously note that your products may not partly correspond to this manual due to the quality and performance improvement, and the change of components for certain reasons.

2. Definition of Symbols

This manual includes the essential contents for safe and proper usage and preventing users and other people from the harm and damage.

The notes are classified into "DANGER", "WARNING" and "CAUTION" as follows. However, even items classified into "CAUTION" could cause serious results according to circumstances. Always follow instructions of each category that has essential contents for safety.

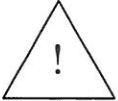
 DANGER	Death or serious injury occurs if the instruction is not followed.
---	--

 WARNING	Death or serious injury may occur if the instruction is not followed.
--	---

 CAUTION	Slight injury or only material damage may occur if the instruction is not followed.
--	---

The serious injury described above means the ones having aftereffects, or requiring hospitalization or long outpatient visits for remedy such as blindness, injury, burns (at high/low temperature), electric shock, bone fracture and poisoning, etc. The slight injury means the injury, burn or electric shock, etc. not requiring hospitalization or long outpatient visits for remedy. The material damage means the expansive one that involves houses, household goods, live stock or pets, etc.

3. Symbols and Parts Name

The symbols shown below are labeled on the main unit as the most essential hazard in this manual. Before use, be sure to check them and fully understand the meanings.

If the symbols become hard to read, replace them with new ones to identify them clearly.

■ Main Unit

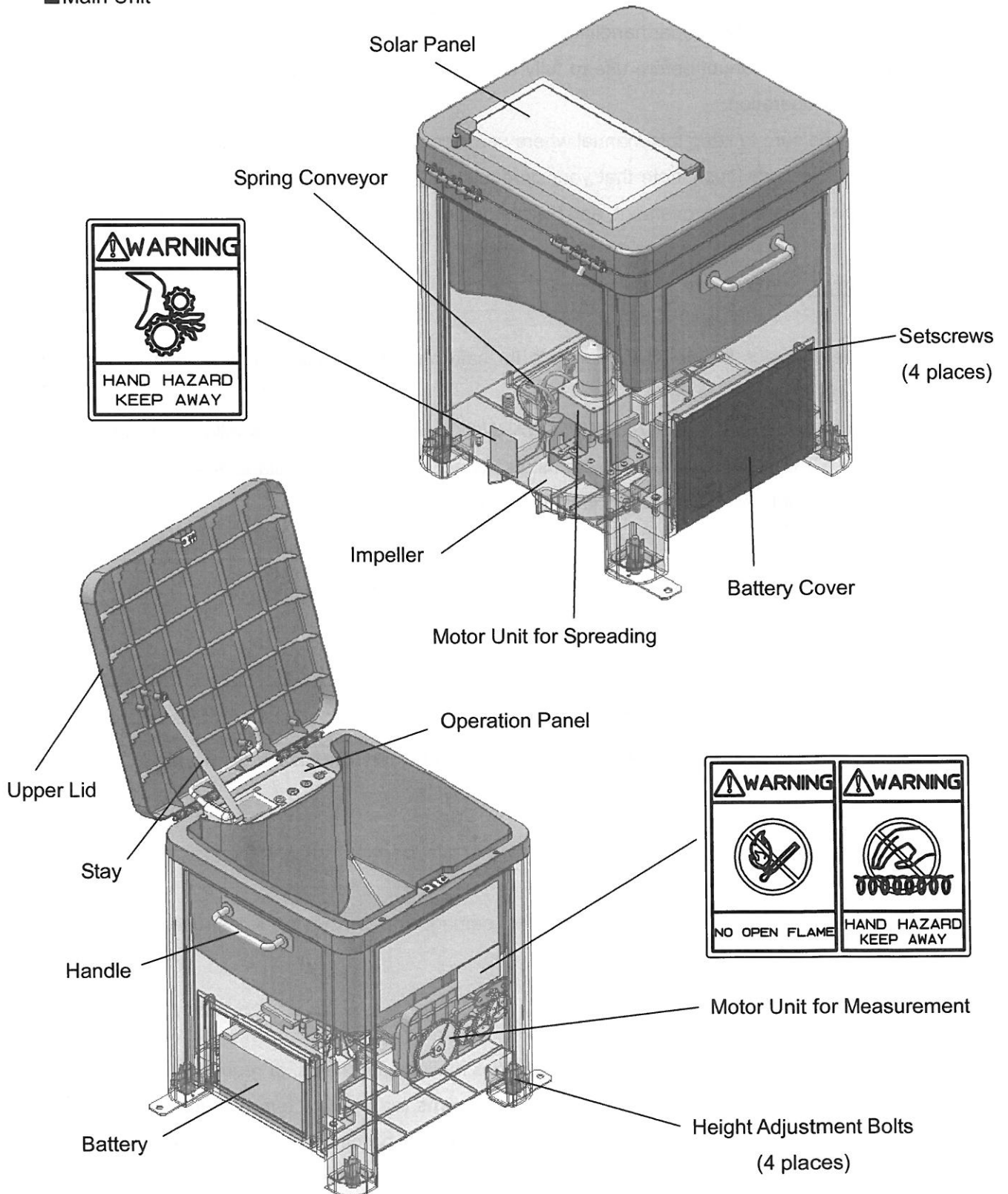

■Operation Panel

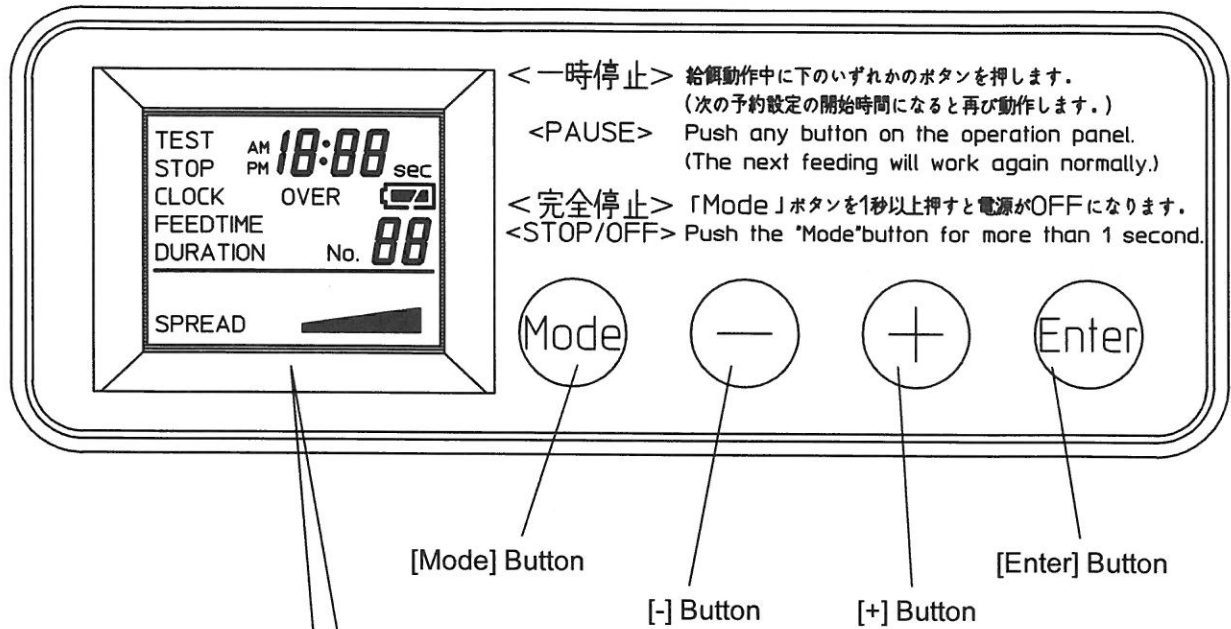

Operating Part

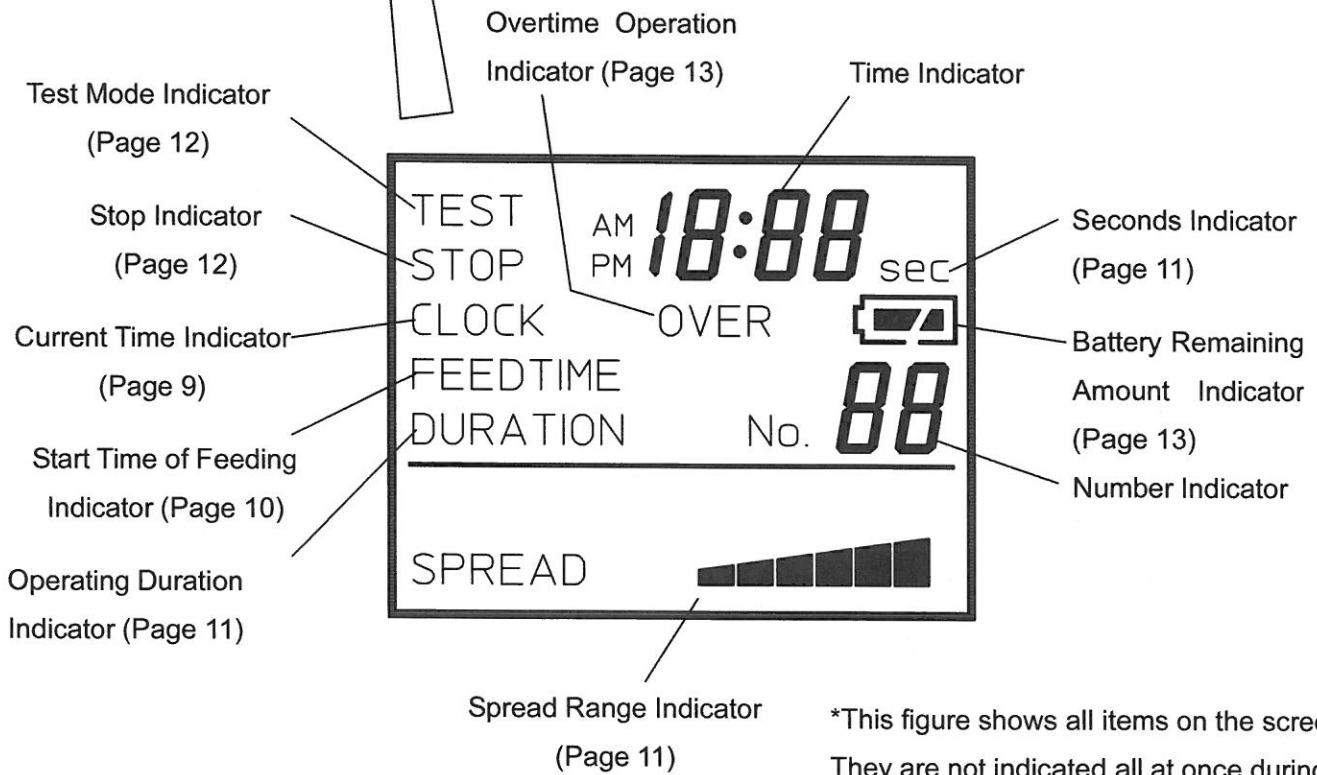



Indication Descriptions

Reference pages are shown in ().

4. Safety Concerns

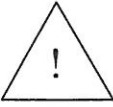
To ensure long term and safe operation of this device, please understand fully the following items and make efforts for the safe operation, and maintenance and inspection.

 DANGER	<ul style="list-style-type: none">- Battery may give off hydrogen gas. Simply keep the battery away from open flames and do not use it near sparkly parts or devices such as fuses and switches. Do not store the battery in the enclosed space and incorporate it in the devices with enclosed structure. Explosion, fire, burst of the device, or damage to human bodies could be resulted.
---	---

 DANGER	<ul style="list-style-type: none">- When replacing a battery, cover the solar panel with a cloth (or other shade materials). Otherwise there are risks of sparks and explosion by ignition of the battery.
---	--

 DANGER	<ul style="list-style-type: none">- Do not connect "+" and "-" terminals of the battery with metallic parts such as wires. Use metal tools such as drivers, spanners and torque wrenches, isolated by vinyl tapes or the like. Short terminals of the battery could result in burns, battery damage and explosion by ignition.
--	--

 DANGER	<ul style="list-style-type: none">- Do not mix different types of batteries such as dry cells and NiCd batteries, batteries with different capacities or old and new batteries. Explosion, fire or damage to human bodies could be resulted.
---	--

 DANGER	<ul style="list-style-type: none">- Connect connectors firmly. Loosening of battery terminals (connections) could result in loose connection (overheat or sparks), which involves the risk of explosion by ignition.
---	--

 WARNING	<ul style="list-style-type: none">- Spring conveyor in the tank involves the risk of catching up your hands or cloths. Simply keep your hands and others away from the spring conveyor.
--	---

 WARNING	<ul style="list-style-type: none">- Impellers are rotating at a high velocity. Accessing hands or feet to them could cause catching up or pinching. Simply keep your hands and feet away from Auto Feeder during operation.
--	---

 WARNING	<ul style="list-style-type: none">- Pellets come out from the spreading part of the feeder during operation. Looking into the part involves a risk of damaging your eyes or face. Do not look into the spreading part.
--	--

 WARNING	<ul style="list-style-type: none">- Be sure not to connect terminals with the wrong polarity (“+” or “-“). Reverse connection could result in fire or damage of electronic controllers.
--	---

 WARNING	<ul style="list-style-type: none">- Do not connect the battery directly with an outlet or a cigarette outlet of car, or battery leakage, overheat, explosion, fire and burns could be resulted.
--	---

 WARNING	<ul style="list-style-type: none">- Do not throw the battery into the fire or heat it, or explosion by ignition could be resulted.
--	--

 WARNING	<ul style="list-style-type: none">- Do not disassemble, remodel or break down the battery, or battery leakage, overheat and explosion could be resulted.
--	--

 WARNING	<ul style="list-style-type: none">- Clean and check the battery after removing the static electricity of the human body by touching metal parts at a distance from the battery. Do not clean the battery by dried cloths or dusters. Clean the battery with wetted and tightly wrung cloths. Sparks caused by the static electricity could involve the risk of battery explosion by ignition.
--	---

 WARNING	<ul style="list-style-type: none">- When handling the battery, ensure to put on the protective glasses and rubber gloves, or the dilute sulfuric acid contained in the battery could cause the blindness or burns.
--	--

 WARNING	<ul style="list-style-type: none">- Battery has an active drug, dilute sulfuric acid in it. If the solution leaked and touched your skin and clothes, wash it off with clean water. If the solution comes into contact with the eyes, immediately wash it off with clean water and get medical attention. Contacting dilute sulfuric acid with eyes could result in the blindness and touching skin could result in burns.
--	--

 CAUTION	<ul style="list-style-type: none"> - Be careful not to have your hands caught in the upper lid when opening since it could suddenly close by wind.
--	---

 CAUTION	<ul style="list-style-type: none"> - If you find any of rust, cracks, deformation, overheat or other defects when first using after purchase, notify the purchased dealer without using, or battery leakage, overheat and explosion could be resulted.
--	---

 CAUTION	<ul style="list-style-type: none"> - Keep the battery out of reach of children. Keep infants and children away from the battery when charging and using.
--	---

 CAUTION	<ul style="list-style-type: none"> - Operating temperature range is as follows. Using out of this range could shorten the performance and life of the battery, or result in battery leakage, damage and deformation. - Discharge: -15 to 50°C (During operation) - Charge: 0 to 40°C - Storage: -15 to 40°C (Below 30°C is desirable.)
--	--

 CAUTION	<ul style="list-style-type: none"> - Do not use or store the battery in sun-heated cars, locations which receive direct sunlight or in front of a stove, of which temperature is at over 50°C. Battery performance and life could be shortened and leakage, damage and deformation could be resulted.
--	--

 CAUTION	<ul style="list-style-type: none"> - Do not give strong impact by hitting or dropping the battery. Do not use it at the heavily vibrating location. Battery damage could be resulted.
--	--

 CAUTION	<ul style="list-style-type: none"> - Do not use organic solvents or detergents such as thinner, gasoline or benzene. Contacting organic solvents or detergents with battery case could result in the breakage of battery case and leakage by cracks.
--	---

 CAUTION	<ul style="list-style-type: none"> - When leaving the device unused for a long time, remove the battery from the feeder and store it in a cool and dark environment. In this case additional charge of every two month is required.
--	--



- Used lead battery will be recycled. Return it to the dealer that you purchased the new one. Since the used battery still has electric energy, short between terminals could be resulted in overheat, ignition or burst.

[2] Installation

1. Setting of Main Unit

Adjust height adjustment bolts to stabilize the feeder.

2. Installation of Anchor Plate

Anchor Plates (2pcs.) for setting to the main unit are included as standard equipments. Use them at need.

- (1) Take off the Height Adjustment Bolt at the place where Anchor Plate is to be installed.
- (2) Fix Anchor Plate to main unit with two attached screws.
- (3) Set the Height Adjustment Bolt that was taken off from the main unit.

- * Take a proper measure depending on the setting condition and place.
- * During the above operation, remove the battery.

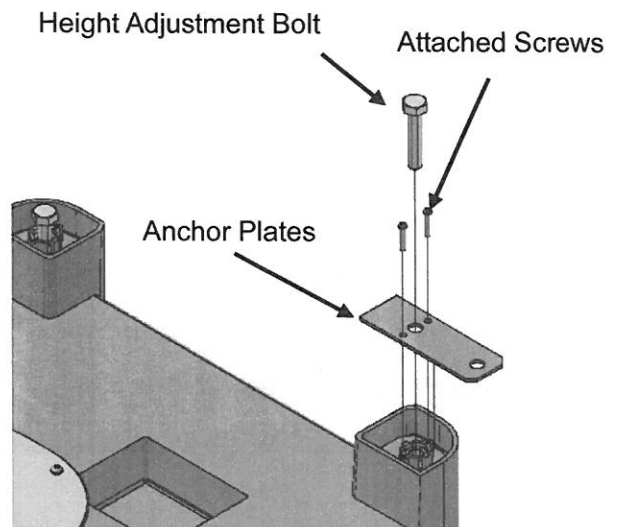

3. Battery Connection

- Feeding Master work on HP6.5-12 battery.
- Cover the solar panel with a cloth (or other shade materials).
- Unscrew four setscrews from the battery cover to remove the cover taking care not to break the packing (see page 2).
- Bring the battery down sideways as in the picture at right, hang the fixing band to the terminal face, and raising the battery, set it at the fixed place. (If the battery is brought down, there is no worry of liquid leakage.)
- Connect firmly the red connecting wire with "+" terminal and the black wire with "-".

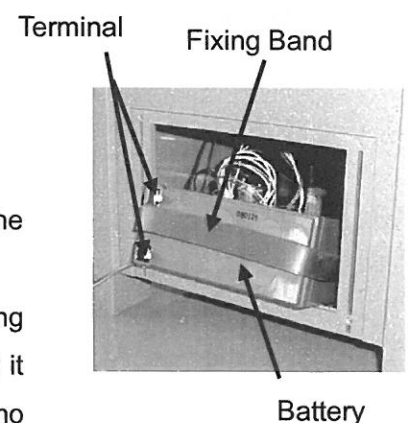

Note: When connecting or removing the battery, or storing the device without the battery, cover the solar panel with a cloth (or other shade materials).
Otherwise the electronic controller could be failed.

[3] How to Operate

Indications will be switched as follows by pressing [Mode] button.

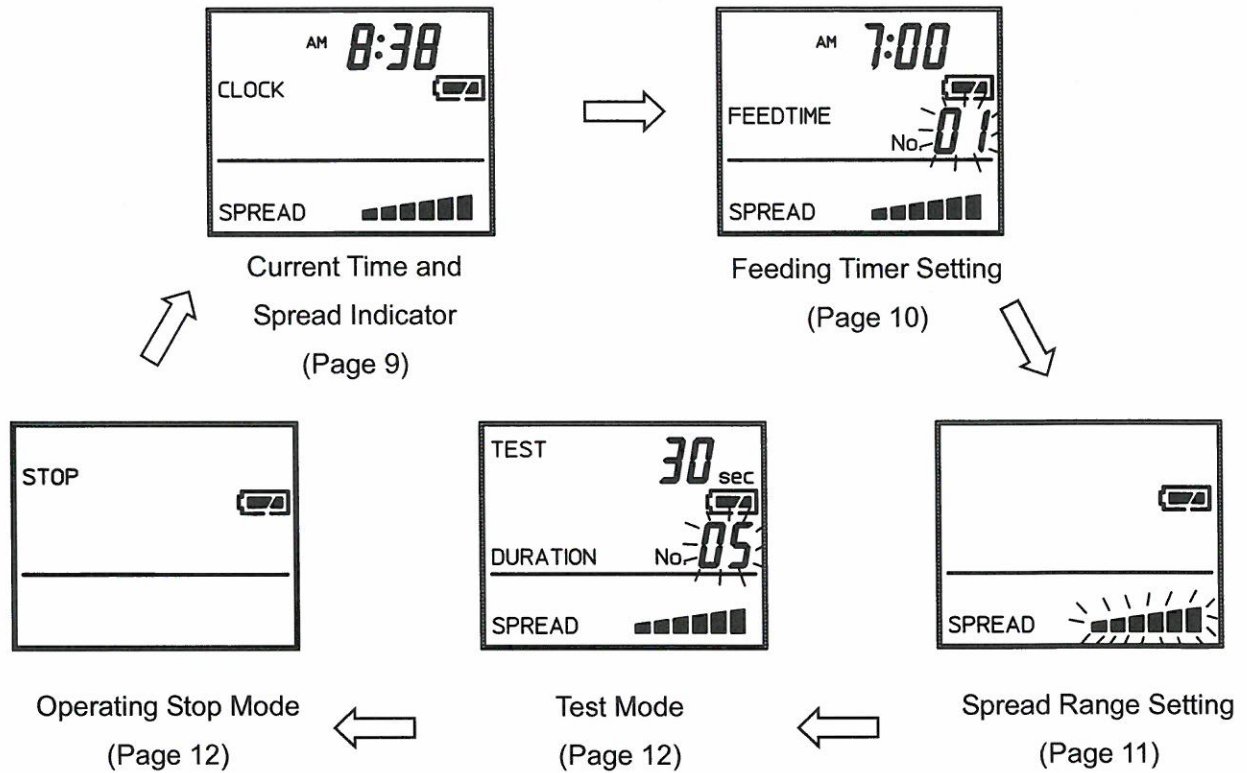

<How to Pause (Emergency Stop)>

Press any keys during operation to pause (Emergency stop).

During feeding operation .. Timer during operation is cancelled.

Operation will start again at the next feeding time.

During test mode Testing is cancelled.

Select the reservation number to be tested again to perform testing (See page 12).

1. Feeding

- Put the feed using for Feeding Master into the tank. Maximum capacity is approximately 5kg.

- ① Open the upper lid.
- ② Put the feed into the tank.
- ③ Ensure to close the upper lid after putting the feed.

The upper lid could be damaged by wind if it is not closed properly.

Note: Be careful not to drop pieces of paper bags or threads into the tank.

They could result in entanglement around the spring conveyor and the shaft of the impeller, which causes defects.

2. Current Time Setting

- Set the built-in clock in Feeding Master.

<<When setting at 8:38 a.m.>>

Connect the battery. Operating stop mode "STOP" is indicated. (See page 14.)

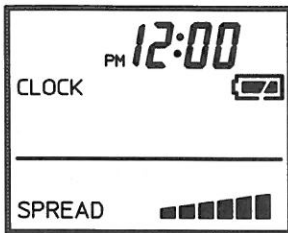
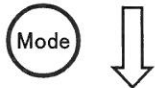
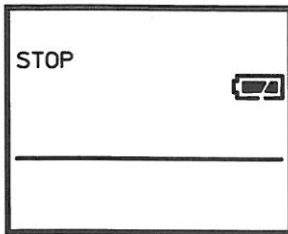

- ① Press [Mode] button. The current time "CLOCK" and spreading range "SPREAD" are indicated.

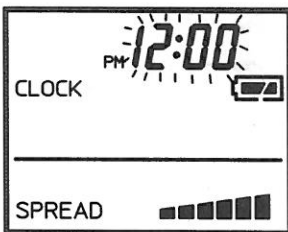
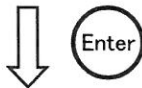

- ② Press "Enter" button. The number of time indicator blanks.

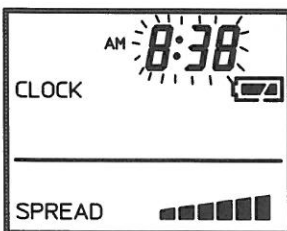

- ③ Pressing "+" or "-" button increase or decrease the time by minutes. Set the time.

*If you want to advance the clock rapidly, keep pressing "+" or "-" button.

*Next of 11:59 a.m. is 12:00 p.m. and next of 11:59 p.m. is 12:00 a.m.

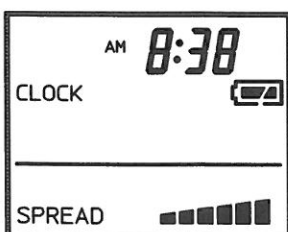

- ④ Pressing [Enter] button completes the current time setting. The current time and spread range are indicated.

Note: If the battery is removed, the clock stops. For reconnection, reset the current time.

Note: In case of using under high temperature, the clock tends to gain. Confirm the current time periodically.

3. Feeding Timer Setting

- Set the start time of feeding and feeding duration of Feeding Master.

At the set time Feeding Master activates and starts feeding.

Maximum 12 feeding patterns per day can be set.

Different patterns of feeding duration are available for each time setting.

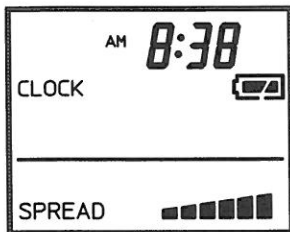

<<In case of Reservation No.: 5, Start Time of Feeding: 2:25 p.m., Duration: 30 seconds>>

- Current time and spread range are indicated.

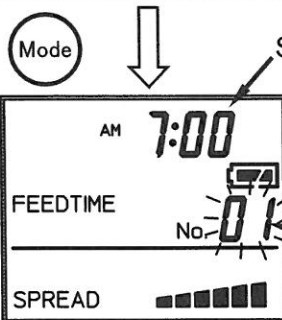

Start time of feeding of the indicated reservation No.

① Press [Mode] button to indicate "FEEDTIME" and activate the start time of feeding mode. The two digits number indicating the reservation No. blinks.

Reservation No.

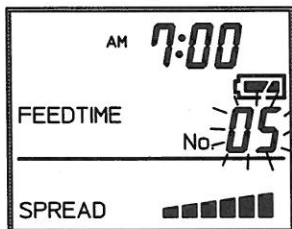
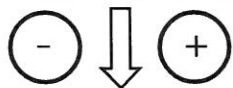

② Press "+" or "-" button to select the reservation No. from 01 to 12.

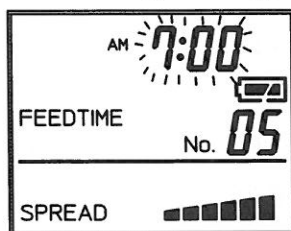

③ Press [Enter] button. The numbers indicating the start time of feeding blinks.

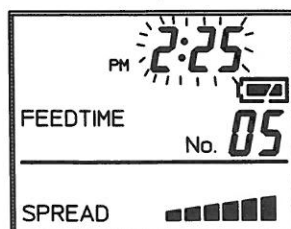
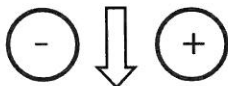

④ Press "+" or "-" button to set the time. Time increases or decreases by minutes
*If you want to advance the clock rapidly, keep pressing "+" or "-" button.



Feeding duration of the indicating reservation No.

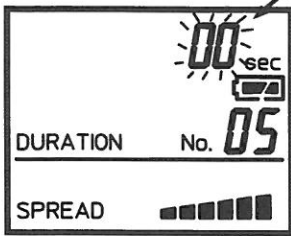

- ⑤ Press [Enter] button to indicate "DURATION" and activate the feeding duration setting mode.

The two-digit number at the upper right corner blinks and "sec" is indicated beside of them.

The blinking two digit number represents the feeding duration (seconds).

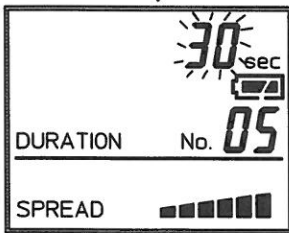

- ⑥ Press "+" or "-" button to set the feeding duration from 01 to 99 seconds.

When setting the duration as 00, the setting is set as stop.

*If you do not set all 12 patterns, set the feeding duration of all unused reservation No. as 00.

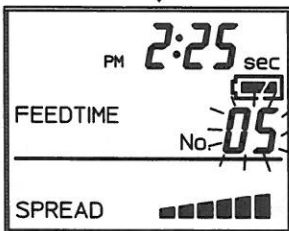

- ⑦ Press [Enter] button to complete the feeding duration setting mode.

- ⑧ Repeat the procedures of ② to ⑦ to set the start time of feeding and feeding duration depending on the reservation type.

4. Spread Range Setting

- Set the spread range of the feed.

<<In case of Spread Range: Maximum>>

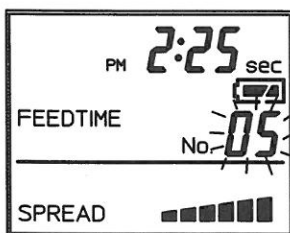

- Feeding Timer Setting mode "FEEDTIME" (the reservation number is blinking) is indicated.

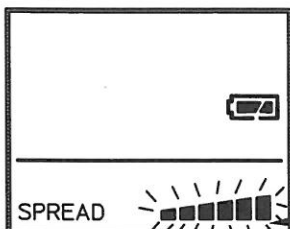

- ① Press [Mode] button to indicate only "SPREAD" and activate Spread Range Setting mode. The level gauge at the right side blinks.

- ② Press "+" or "-" button to adjust the spread range.

Spread range

*The spread range depends on the feed type. Try to spread the feed in Test mode to adjust the range.

*The set spread range is applied to all reservations regardless of the reservation number.

*Frequent occurrence of pinching of the feed is caused by weak revolution. Increase the level gauge.

5. Test Mode

- Testing with the feeding duration and spread range of the set reservation No. is available.

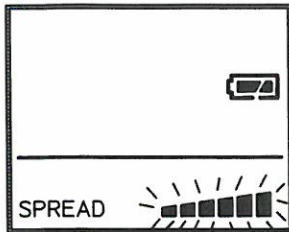

- Spread Range Setting mode is indicated.

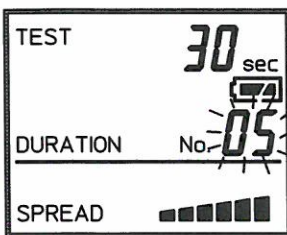

① Press [Mode] button to indicate "TEST" at the upper left corner. Reservation No. blinks.

② Press "+" or "-" button to select Reservation No. The set feeding duration is indicated.

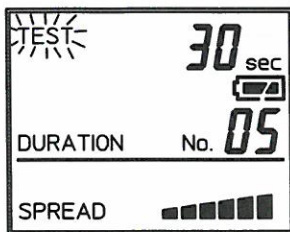

③ Press [Enter] button. "TEST" blinks and test is performed according to the indicated feeding duration and spread range.

④ After completing the feeding operation, the screen returns to 5-① status.

*When leaving the device unused for 1 minute in 5-① status, the screen returns to operation stop mode indicating "STOP". (See Page 12.)

6. Stop Setting

- Stop all feeding operations.

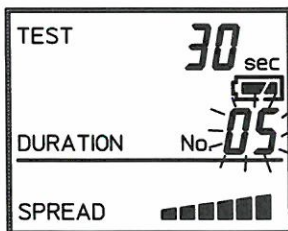

- Test mode status is indicated.

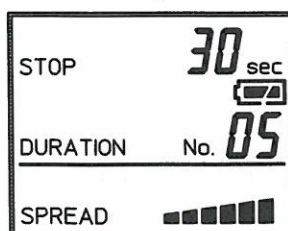

① Press [Mode] button to indicate "STOP". All feeding operations stop.

*Keep pressing [Mode] button (one second) in any modes can stop the feeding operation.

② Press [Mode] button again to return to Current Time and Spread Range Indicator.

7. Instructions for Use

- The maximum feeding duration per day is 15 minutes. When total operating duration exceeds 15 minutes, "OVER" indicator blinks. Set the operating duration to avoid the "OVER" indication. Otherwise over discharge could occur because the electric consumption exceeds the supply from the solar panel. Even for use within 15 minutes, over discharge (running out of the battery) could occur depending on the amount of isolation, weather and duration of sunshine. In this case activate the "Stop" mode (See page 12.) and irradiate the solar panel sufficiently until the "Battery Remaining Amount Indicator

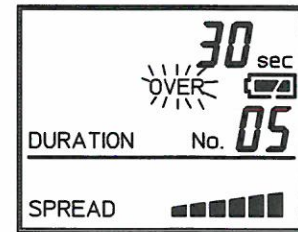

[4] Handling of Solar Panel

- To generate electricity efficiently, install the device at the place where the solar panel can be irradiated sufficiently by direct sunshine through the day and avoid installing the device beside of the shielding net or in the shadow of other objects.
- Dirty solar panel deteriorates the power generation efficiency and over discharge of the battery could be resulted in. Wipe it out with a wet cloth if it gets dirty.

[5] Handling of Battery

- Normally the battery charge is not necessary since the electric power is charged by the solar panel. However, when it rains for days or the operating duration of a day is long, the remaining amount of the battery gets low and the Battery Remaining Amount Indicator may be indicated as the right figure. In this case activate the Stop mode (see page 12) and irradiate the solar panel sufficiently until the "Battery Remaining Amount Indicator" is restored.

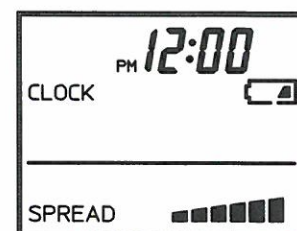

In case of charging additionally, be sure to use a battery charger for valve regulated lead-acid batteries. (Charging Voltage: 14.6~15V, Initial Current: 1.95A or less)

Be sure not to use especially the battery charger for cars with big capacity, because overheat and burst may occur.

- When leaving the device unused for a long time, cover the solar panel with a cloth (or other shade materials) and disconnect the battery connectors.
- Other cautions regarding battery are stated in "Safety Concerns" in this book (See page 4.). Be sure to check them before operating.

[6] Protective Function

- If overload of the spring conveyor or impeller occurs by foreign matters or pinching of the feed, the protective function activates to cut off the current supply to motors.

To release the function, cover the solar panel with a cloth (or other shade materials), disconnect the battery connectors and remove foreign matters or others. Then reconnect the connectors firmly.

The clock stops while battery removing, so set the current time again. (See page 9)

[7] Cleaning

- When the inside of tank gets dirty, wipe out with a wet cloth.
- Do not put the feed until the inside of tank gets dry completely.
Putting the feed under the wet condition could result in the defect by the feed sticking.
- Remove the feed on the spreading part clean from time to time.

[8] Maintenance and Inspection

1. Motor Units

- If abnormal noise is heard or normal revolutions are not achieved, the motor unit life could be expired.
Please contact the dealer.

[9] Specifications

Model Type	PFX-17LS-DSF
W X D X H (mm)	350 X 350 X 465 (projections excluded)
Weight (kg)	9.3
Capacity (L)	17.0
Feed method	Spread method
Rated voltage (Power supply)	DC-12V (Battery) (HP-6.5-12 Small-sized Value Regulated Lead-Acid Battery)
Feed targeted diameter (mm)	$\phi 2 - \phi 12$
Timer	Microcomputer control, 24 hours timer
Main unit material	Resin (ASA,ABS)
Available duration (per day)	15 minutes (in fine weather in summer)

Note: The available duration may be shortened due to weather or the like.

The above specifications are subject to change without notice.

[10] Troubleshooting

- If you find something wrong during operation, stop using to prevent accidents and contact the dealer.

Symptom	Cause	Measure	Reference page
Spring conveyor does not work.	Protective function is activated.	Disconnect the connector and reconnect it.	14
	Motor damage	Contact the dealer.	-
	Operation panel damage	Contact the dealer.	-
	Spring conveyor damage	Contact the dealer.	-
Spread impeller does not work.	Deterioration of battery performance	①Solar panel surface is dirty. ->Cleaning of solar panel surface	13
		②Solar panel is not irradiated sufficiently. ->Adjust the feeder position to irradiate the solar panel with sufficient sunshine.	-
		③The feeding (operating) duration of a day is long. ->Reduce the feeding duration.	10, 13
		④Battery consumption ->Battery charge ->Battery replacement	13
Feeding is not performed at the set time.	Missetting of the current time of the operation panel	Set the current time again.	9
	Operation panel damage	Contact the dealer.	-
Feed does not come out	Clogging of feed at spreading part	Remove the feed. Increase spreading level.	11
	Wear of impeller	Change the impeller.	-
	Wear and tear of impeller cover	Change the impeller cover.	-

[11] Standard Gross Discharging Amount of Feed

Type	Size		Standard feed discharging amount per minute
Floating	SS	1.7 ~ 2.0 mm	230 g
	S	2.7 ~ 3.0 mm	270 g
	M	5.0 ~ 5.5 mm	220 g
	LM	6.5 ~ 7.5 mm	230 g
	L	8.0 ~ 9.0mm	180 g
Sinking	SSS	1.3 ~ 1.5mm	300 g
	SS	1.7 ~ 2.0mm	300 g
	S	2.7 ~ 3.0mm	360 g
	M	5.0 ~ 5.5mm	350 g
	LM	6.5 ~ 7.5mm	340 g

Standard gross discharging amount per one operation can be calculated as follows:

Gross discharging amount (g) =

$$\text{Feed discharging amount per minute (g/min.)} \times \text{Operation time (min.)}$$

*Feed discharging amount changes depending on the specific gravity and size of the feed. Use the value for reference only.

■ Manufacturer

Fukushin Electric Co.,Ltd
447-1 Fukuda,
Fukusaki-cho Kanzaki-gun,
Hyogo 679-2288 Japan
TEL : +81-790-22-0880
FAX : +81-790-23-0508
URL : <http://www.felco.co.jp>

