

### 3: Backup driver

Step1.Connect the wires according to the wiring diagram. (Figure 14)

Wiring diagram (Maintained)

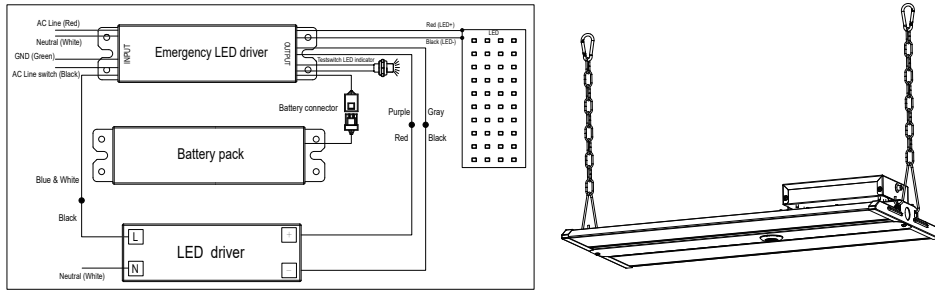
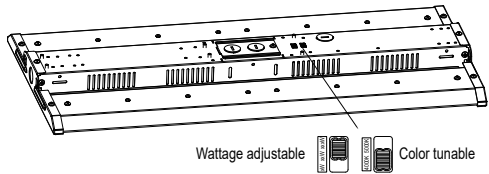

Figure 14

### CCT & Wattage Adjustment

Wattage adjustment switch + CCT tunable switch



Wattage adjustable Color tunable

### Warning / Avertissement

#### MIN 90 °C SUPPLY CONDUCTORS

**THIS PRODUCT MUST BE INSTALLED IN ACCORDANCE WITH THE APPLICABLE INSTALLATION CODE BY A PERSON FAMILIAR WITH THE CONSTRUCTION AND OPERATION OF THE PRODUCT AND THE HAZARDS INVOLVED.**

#### LES FILS D'ALIMENTATION 90 °C MIN

**CE PRODUIT DOIT ÊTRE INSTALLÉ SELON LE CODE D'INSTALLATION PERTINENT, PAR UNE PERSONNE QUI CONNAÎT BIEN LE PRODUIT ET SON FONCTIONNEMENT AINSI QUE LES RISQUES INHÉRENTS.**

# LED Linear High Bay Installation Instruction

### Cautions:

1. Do not use any electric generator to test the LED light.
2. Please abide by related country, regional and local law and regulations when installing this fixture.
3. Please turn off the power before installation or maintenance.
4. Proper earth grounding is required to ensure safety.

### Notice:

1. To avoid possibility of electrical shock or fire, the installation personnel must have professional electric knowledge.
2. Please wear gloves to avoid injury before installation.
3. If any smoke or spark of the wire happened, please turn off the power immediately and notify relevant personnel.
4. Please use listed strain relief bushing when connecting the supply cord to the outlet box.

### Attention:

1. Please check if there is any damage during shipping. If so, please contact manufacturer timely.
2. Please read the installation instruction carefully to check whether all the accessories are complete. After confirmation, install the fixture according to installation steps.

### Wiring Diagram & Instruction:

3 dimming functions are available in this high bay light:

1. Constant current can be achieved by 0/1-10VDC dimming;
2. PWM signal dimming;
3. Variation of resistance unit dimming.

Description:	
This product is 0/1-10V dimming, below dimmers are recommended:	
Brand	Model
LUTON	NTSTV-DV
LEVITON	DS710-10Z / IP710
LEGRAND	RH4FBL3PW

### Wiring Instruction

L:Black,  
N:White,  
⊕ : Green/Yellow

DIM +  
DIM -

(As for the wire color of DIM+ and DIM-, pls check the light label.)

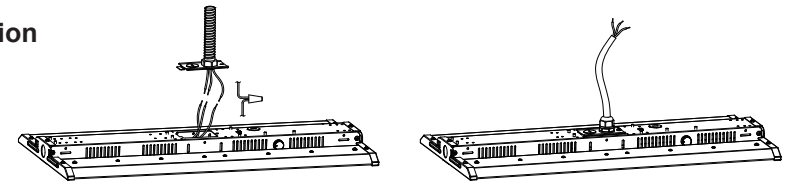

Please choose the appropriate dimming way according to your needs. You can also choose not to use this function.

\*The product can not be connected to a dimming device when it's equipped with Motion Sensor.

Three Installation: Chain/Cable installation, 3/4" NPT Installation, Surface Mounting  
**(Please choose the most suitable installation method for the purchased product as per your needs)**

### A. Hanging Installation: ( Chain/Cable)

- Step1. Hook up the chain; (Figure 1)
- Step2. Connect the chain with fixture; (Figure 1)
- Step3. Fix the chain on the rail, adjust the chain length as per need; (Figure 1)
- Step4. After fixed , choose suitable wiring knock out, connect the wires according to local standard and code.

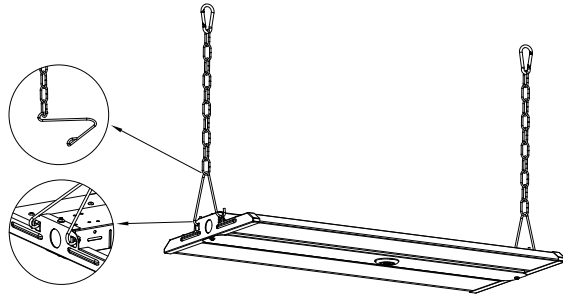

Figure 1

### B. 3/4" NPT Installation:

- Step1. Mount the bracket on 3/4" NPT; (Figure 2)
- Step2. Lock fixture on the bracket; (Figure 3)
- Step3. Connect the wires according to local standard and code.
- Step4 Lock side brackets with screw driver. (Figure 4)



Figure 2

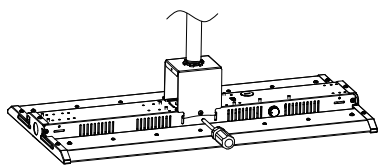

Figure 3

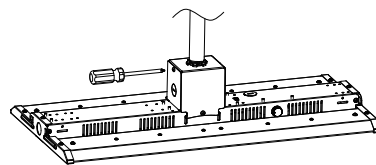

Figure 4

### C. Surface Mounting: (If this bracket is used for the fixture, backup driver solution cannot be chosen)

- Step1. Mount the bracket on the rail or ceiling (Figure 5);
- Step2. Assemble the lamp on the bracket and fix it with screws (Figure 6);
- Step3. After mounting, choose suitable wiring knock out and connect the wires according to local standard and code.

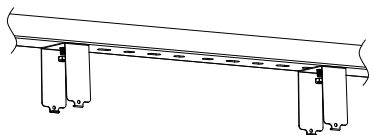

Figure 5

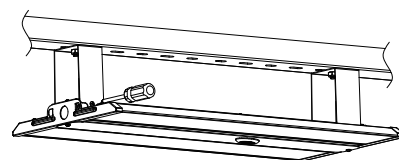

Figure 6

### Extra Accessory Option Installation: 1:Wire Guard, 2:Motion Sensor / PIR Sensor,3: Backup driver

#### 1.Wire Guard: (Purchase the correct size wire guard from manufacturer)

- Step1. Unscrew the two screws on the front of the lamp; (Figure 7)
- Step2. Place the wire guard on the lamp and fix it with screws. (Figure 8)

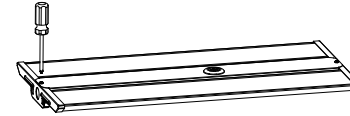

Figure 7

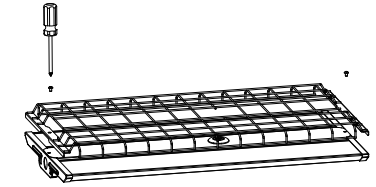

Figure 8

#### 2-1. Motion Sensor / PIR Sensor: (Both sensor are with same installation)

- Step1. Open the face cover with screw driver;(Figure 9)
- Step2. Knock out the side cover, mount the sensor on the side, do wiring according to instruction on sensor; (Figure 10)
- Step3. Put face cover back with screw driver. (Figure 11)

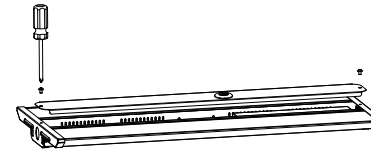

Figure 9

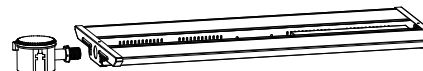
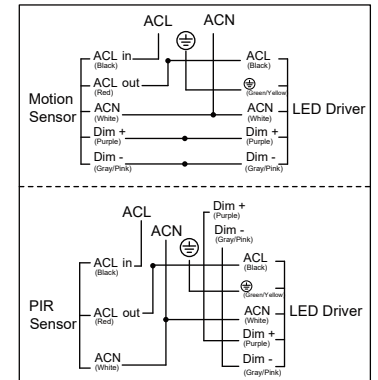

Figure 10



Figure 11

#### Wiring Instruction



#### 2-2. DC Motion Sensor / PIR Sensor (Both sensors are with the same installation method)

- Step1. Use a screwdriver to remove the 1/2 plug from the sensor; (Figure 12)
- Step2. Twist-lock the DC sensor to the base to make it work properly, use a remote control to adjust the working mode as per demand. (Figure 13)

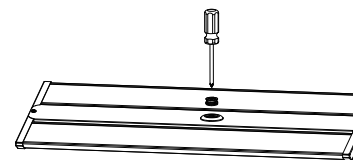

Figure 12

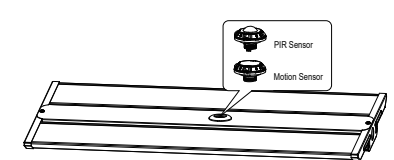

Figure 13