



HAIRMAX[®]

The science of hair growth.[®]



FLIP80

laser hair growth cap

USER MANUAL

C Model

TABLE OF CONTENTS

What you should know before you start

Introduction.....	2
Who is the best candidate? (Classifications male/female).....	3
Who is the best candidate? (Fitzpatrick Skin Types).....	4
Warnings and Cautions	5
Risks/Symbols/Testing for Sensitivity.....	6
How to Monitor Device Activity	7
Device Failure Mode	7
Expected Life of your Device	7
Summary of Clinical Study in Men.....	8
Summary of Clinical Study in Women	9

HairMax® Laser Device

Parts.....	10
Getting Started.....	11
Charging.....	11
Proper Use.....	12
Treatment Instructions	13
What is Included.....	14
Troubleshooting	15
Maintenance/Cleaning	16
Disposal Instructions.....	16

Other Useful Information

Warning Labels.....	17
Laser Parameters	17
Use Conditions	17
Power Supply Specifications.....	17
Electrical Safety.....	18
Electromagnetic Immunity Guidance	19
Electromagnetic Distance Recommendations.....	22
Warranty	23

Corporate Office – Customer Service – Warranty Repairs

Lexington Intl., LLC
1040 Holland Drive
Boca Raton, Florida 33487 USA
Email: info@HairMax.com
www.HairMax.com

Direct line +1 561-417-0200

United States and Canada 1-866-527-3726

United Kingdom 0808-134-9868

Australia +61 7 3198 2484

Monday - Friday 9 AM - 5 PM ET

©2020 Lexington Intl., LLC. All rights reserved.

It is important that you read and understand the content of this user manual before using your HairMax Laser Device.

Introduction of HairMax Laser Device

Your HairMax Laser Device is a home-use laser device that utilizes Clinically Proven Technology to treat male and female pattern hair loss, also known as hereditary hair loss in men and women. HairMax Laser Device is an over-the-counter (OTC) device that can be sold directly to the public.

Your HairMax Laser Device can be worn by itself or inserted into your favorite sports cap.

Indications

HairMax Laser devices are indicated to promote hair growth in males with Androgenetic alopecia who have Norwood-Hamilton Classifications of IIa - V, and in females with Androgenetic alopecia who have Ludwig (Savin) Classifications I - II or frontal patterns of hair loss and who both have Fitzpatrick Skin Types I - IV.

How HairMax Laser Devices work

HairMax Laser Devices work by providing laser energy to stimulate hair follicles.

Treatment with HairMax Laser Device

The HairMax Laser Device should be used 3 times per week, on non-consecutive days. For example, Monday, Wednesday, Friday. The HairMax Laser Device should not be used more than the recommended treatment time per day. Clinical studies using HairMax technology demonstrate that most users see benefits in as little as 16 weeks.

HairMax Laser Device Benefits

A clinical study using this technology was conducted in men and women over a six month time period. The study showed that 90% of the men and women had an increase in the hair count of 129 additional hairs per inch square. See pages 8-9 for detailed results of the study.

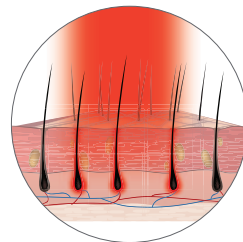

WHO IS THE BEST CANDIDATE FOR THE HAIRMAX® LASER DEVICE?

How do you know if the HairMax Laser Device is right for you?

The HairMax Laser Device can be used by men and women with thinning hair (including color treated hair) or pattern baldness caused by a hereditary condition. Doctors use a system known as the Norwood Hamilton Classification (men) and the Ludwig-Savin Classification (women) to describe the degree of hair loss. Below are the pictures of the scales. The shaded areas show the type of hair loss that can be treated with HairMax Laser Device.

Norwood Hamilton
Classification - Males

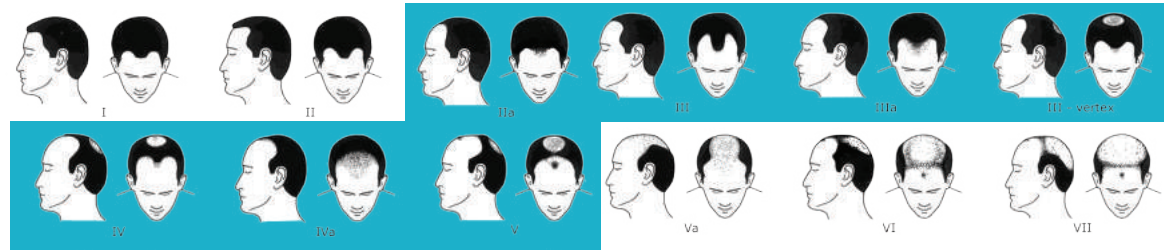

Ludwig-Savin
Classification - Females

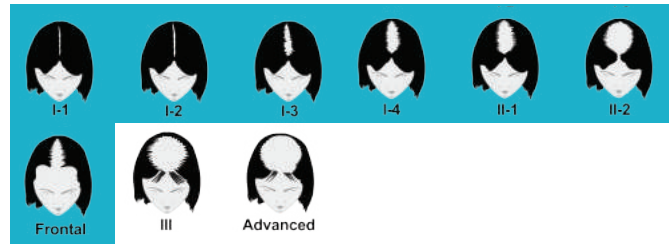

HairMax Laser Device has not been clinically tested for hair loss outside of the shaded areas.

WHO IS THE BEST CANDIDATE FOR THE HAIRMAX® LASER DEVICE?

HairMax® technology was studied in very white to brown skin tones (Types 1, 2, 3, 4) as described in the Fitzpatrick scale below. This does not mean it will not work on the darkest skin tones. Due to limitations of digital photography and hair counting software we were unable to test the darkest skin tones.

Fitzpatrick Skin Type Classification Guide:

A way to describe your skin type based on your complexion and what happens to your skin in sunlight

Type 1	Clinically Tested to be effective for these skin types	Very white or freckled skin, always burns with sun exposure (very fair; often in people with red or blond hair and blue eyes)
Type 2		White skin, usually burns with sun exposure (fair; often in people with red or blond hair and blue, green, or hazel eyes)
Type 3		White or olive skin tone, sometimes burns with sun exposure (fair; seen in people with any hair or eye color)
Type 4		Brown skin, rarely burns with sun exposure (common in people of Mediterranean descent)
Type 5	Not Clinically Tested for these skin types	Dark brown skin, very rarely burns with sun exposure (common in people of Middle-Eastern descent)
Type 6		Black skin, rarely burns with sun exposure

Adapted from Fitzpatrick's Dermatology in General Medicine. McGraw-Hill Professional; 5th edition.

Please note that HairMax was only tested on light to brown skin tones. This does not indicate that it will not work on darker skin tones.

WARNINGS AND CAUTIONS

WARNINGS

- ⚠ Do not stare directly at the red laser light or its reflection in a mirror because it can temporarily irritate your eyes. If you stare at the light for too long, it could harm your eyes. Also, never use a magnifying glass when using HairMax Laser Device because it can cause temporary irritation to your eyes.
- ⚠ Keep the HairMax Laser Device out of the reach of children and pets.
- ⚠ Do not drop your HairMax in water because you may get an electrical shock. If your HairMax Laser Device gets damaged by water, contact customer service toll-free at the numbers provided below.
- ⚠ If the cord is damaged on your HairMax Laser Device, do not use the device because you could get an electrical shock. If the cord gets damaged, contact customer service toll-free at the numbers provided below.
- ⚠ Do not use your HairMax Laser Device near any heated surfaces because this could cause the device not to work properly and may cause an electrical shock. Contact customer service toll-free at the numbers provided below.
- ⚠ **Laser light - avoid direct eye exposure.**
- ⚠ This is a harmless low-level ESD (Electrostatic Discharge) sensitive device. Please do not touch the charging contacts or USB-port. (see page 10). Touching the contacts or USB-port is not of the essential performance and will not cause a basic safety issue. If touching the contacts or USB-port causes the device to malfunction, reset your device by powering off and back on.
- ⚠ No modification of this equipment is allowed.
- ⚠ This equipment has no user-serviceable parts. Do not attempt to modify or repair this equipment.
- ⚠ Do not attempt to modify or service while the equipment is in use.
- ⚠ If this equipment is modified, appropriate inspection and testing must be conducted to ensure continued safe use. Contact Lexington International customer service toll free at the numbers provided below.

CAUTIONS

- ⚠ If you are taking any medications or products that make you sensitive to light, you should test your HairMax Laser Device to make sure you do not have a reaction. Some of the things that can cause increased sensitivity to your HairMax Laser Device could be medicines for colds, allergies, pain medicine and drugs to treat infections. To test your HairMax Laser Device for sensitivity, turn the device on, hold the device on one spot, shining the light on your forearm. After two minutes, turn the device off and set aside. Look at the spot where you held the laser light over the next five minutes. If you see any reaction such as redness or rash, do not use your HairMax Laser Device and contact our customer service toll-free at the numbers provided below for information on how to return your product and get a refund.
- ⚠ Only use your HairMax Laser Device as directed. Do not try to change the way your HairMax Laser Device operates. Altering controls, adjustments, performance or procedures other than those specified herein may result in hazardous radiation (laser) exposure. Contact customer service toll-free at the numbers provided below.
- ⚠ Never use acetone or other solvents on any part of your HairMax Laser Device.

United States and Canada 1-866-527-3726















United Kingdom 0808-134-9868

Australia +61 7 3198 2484

Risks

HairMax® technology has been clinically tested on both men and women. In the clinical study for men, 5% of the men said they had itching or tingling from using this technology. None of the women in the clinical study reported any of these side effects. If you have itching, tingling or any other side effect that bothers you, stop using your device and contact customer service toll-free at the numbers provided below.

Symbols

 Power On/Off	 Laser Warning	 Laser Light Indicator
 RF interference	 Laser	 Type BF Applied Part
 European Conformity	 WEEE	 Serial Number
 Warning	 Caution	 Low-level ESD
 IP22 Degree of Moisture Resistance	 Laser Aperture Indication	 Laser Warning Label

Testing HairMax Laser Device for Sensitivity

Before beginning treatment, be sure to test your HairMax Laser Device for sensitivity. You only need to do this once to test your skin for any reaction to light therapy. Make sure your device is fully charged (see page 11). Place your Laser Device face down on a table.

Turn on the device by pressing the Power Button on the Battery Pack. Wait for the Laser Device to initialize. Place your hand inside the Laser Device, you will see the Red Laser Light.

Allow your hand to stay in the light for 2 minutes. Turn the device off by pressing the Power Button.

Look at your hand. If you don't experience any reaction, proceed with the treatment instructions on page 13. If you see any reaction such as redness or rash, do not use your device. Contact customer service toll-free at the numbers provided below or your place of purchase.

United States and Canada 1-866-527-3726

United Kingdom 0808-134-9868

Australia +61 7 3198 2484

How to Monitor Device Activity

Your HairMax Laser Device is carefully inspected and tested during production. When working properly, the Indicator Light (🔦) and Red Laser Lights on the device turn on.

DO NOT look directly at the laser light.

Shine the laser light onto the palm of your hand to see if the red laser light appears.

If the device Indicator Light is not lit, or if the Red Laser Lights do not appear, contact customer service toll-free at the numbers provided below.

Device Failure Mode

The laser light does not fade or diminish over time. At the end of the laser's life or if it fails for any other reason, the red laser light will no longer shine out of the device.

Expected Life of Your Device

HairMax Laser Device is a medical device manufactured under strict quality controls and validated through GMP (Good Manufacturing Practices). HairMax contains high quality laser diodes designed for optimal performance.

Based on that rating and the durability of the components being used, your HairMax Laser Device is designed to last many years of regular use.

Please take time to read this entire user manual before operating your HairMax Laser Device.

[United States and Canada](#) 1-866-527-3726

[United Kingdom](#) 0808-134-9868

[Australia](#) +61 7 3198 2484

SUMMARY OF CLINICAL STUDY IN MEN

Clinical studies on HairMax® technology were conducted at multiple locations in the United States. Participants in the study were males diagnosed with Androgenetic alopecia, which includes hereditary hair loss, and had light to brown skin tones.

Subjects were divided into two groups, active group and a control group. The control device looked and sounded like the active device but did not include a laser light. The clinical studies adhered to all GCP (Good Clinical Practice) guidelines, were approved by an IRB (Institutional Review Board) and listed on www.clinicaltrials.gov.

During the 6 month clinical study, subjects treated their hair once per day, 3 times per week on non-consecutive days. The number of thick, normal healthy hairs in the target zone were counted at Week 1, Week 16 and Week 26.

Results at the 26 week visit showed that over 90% of the men saw an increase in hair counts.*

No subjects in the study experienced any serious adverse events. In fact, the number and types of adverse events were similar in the active and control groups.

Hair Count Change

In the clinical study, after 26 weeks of treatment with the active device versus the control device, the following increases in hair count were found.



*Based on a minimum of 5 new hairs per square centimeter/32 new hairs per square inch being observed at the follow up visit

Mean Terminal Hair Count Changes
From Baseline in MALES
26 Weeks, Observed Hair Count

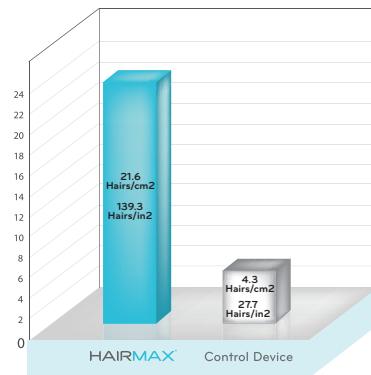

SUMMARY OF CLINICAL STUDY IN WOMEN

A clinical study on HairMax® technology was conducted at multiple locations in the United States. All participants in the study were females, diagnosed with Androgenetic alopecia, which includes hereditary hair loss, and had light to medium skin tones.

Subjects were divided into two groups. One group used the active device and the other group used a control device. The control device looked and sounded like the active device, but did not include a laser light. The clinical studies adhered to all GCP (Good Clinical Practice) guidelines, were approved by an IRB (Institutional Review Board) and listed on www.clinicaltrials.gov.

During the 6 month study, subjects treated their hair once per day, 3 times per week, on non-consecutive days. The number of thick, normal, healthy hairs in the target area were counted at Week 1, Week 16 and Week 26.

Results at 26 weeks showed that over 90% of the women saw increases in hair counts.*

No subjects in the study experienced any serious adverse events. In fact, the number and types of adverse events were similar in the active and control groups.

Hair Count Change

In the clinical study, after 26 weeks of treatment with the active and a control device, the following increases in hair count were found.



*Based on a minimum of 5 new hairs per square centimeter/32 new hairs per square inch being observed at the follow up visit

Mean Terminal Hair Count Changes
From Baseline in FEMALES
26 Weeks, Observed Hair Count

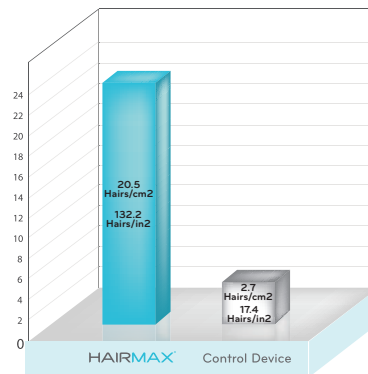

PARTS



A. Storage/Travel Case

B. Battery Pack

C. Laser Device

 **D.** Power Supply with Cord

 **E.** Controller Cable

F. Warning Label

G. Serial Number

H. Power Button

I. Laser Indicator Light



Getting Started

Read this user manual completely before you start to use your device. The instructions in this user manual are intended for individuals with a minimum of an eighth grade education.

HairMax Laser Devices are safe for home use. The patient is the intended operator of this equipment.

When you receive your device, take all the parts out of the case. Make sure your device is clean and dry before beginning the treatment.



Battery Pack

Your HairMax Laser Device comes with a rechargeable Battery Pack.

You must charge the Battery Pack for 3-4 hours before initial use.

ONLY UTILIZE THE PROVIDED BATTERY PACK WITH YOUR HAIRMAX LASER DEVICE. PLUGGING INTO ANY OTHER POWER SOURCE MAY DAMAGE THE DEVICE AND VOID YOUR WARRANTY. DO NOT PLUG YOUR LASER CAP FLIP 80 DIRECTLY INTO THE POWER SUPPLY.

Charging

Charge your HairMax Laser Device by plugging the small end of the Power Cord into the socket on the side of the Battery Pack (Figure A).

Plug the other end of the Power Cord into the USB socket of the Power Supply (Figure B). Plug the Power Supply into an electrical wall outlet.

The indicator lights on the side of the Battery Pack will flash during the charging process. Four steady blue Indicator Lights indicate your device is fully charged (Figure C).

When your HairMax Laser Device is turned on, the indicator lights will illuminate to display the battery level. When your HairMax Laser Device is not turned on, pressing the button on the side of the Battery Pack will display the battery level. As the battery charge diminishes, the Indicator Lights will turn off in a sequence to indicate the remaining charge level of the battery:

4 lights = full **2 lights** = 50% (time to recharge)
3 lights = 75% **1 light** = 25%

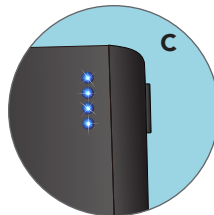
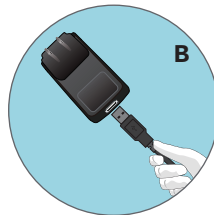
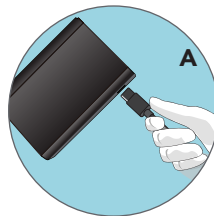

Before Starting Your Treatment:

1. Make sure the battery is **FULLY CHARGED** per the instructions on page 11.
2. Test your HairMax Laser Device for sensitivity (see page 6 of this User Manual).

Proper Use

Your HairMax Laser Device should be used three times per week, on non-consecutive days. For example, Monday, Wednesday, Friday.

Your HairMax Flip 80 Laser Cap is uniquely designed with 80 medical grade lasers configured within half the cap, allowing you to target your treatment where you need it most.

Total treatment time is 15 per area of your scalp, i.e. 15 minutes on the front, 15 minutes on the back or 30 minutes for both. The Flip 80 Laser Cap provides 160 total laser coverage when flipped.



Treat **Partial** Scalp

Treat **Full** Scalp

When charging is complete, disconnect the Power Cord from the Battery Pack and store it for future charging.

Connect the Controller Cable to either of the large USB sockets on the top of the Battery Pack (Figure D). The small USB socket in the middle is not used.

Push the cable into the Battery Pack until it is securely joined (Figure E).

You are now ready to start your treatment.

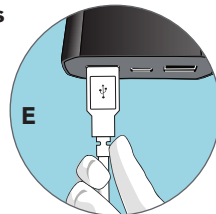
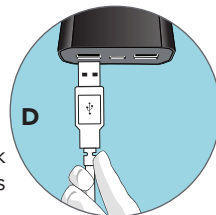

Treatment Instructions

Place the device on your head in a comfortable relaxed position (Figure F). Your HairMax Flip 80 can be used with the lasers in the front of your scalp or in the back of your scalp. Treat this area for 15 minutes. Use a watch or clock to time your treatment.

Press the Power Button on the Controller Cable. (Figure G). The Laser Indicator Light on the Controller Cable will illuminate (Figure H) and the Lasers will turn on.

The Laser Indicator Light on the Controller Cable (Figure H) will indicate your lasers are on and functioning properly.



To treat the second half of your scalp

Once the 15 minute treatment is complete, **Flip your Cap** (Figure I) to treat the other half of your head. Use a watch or clock to time the 15 minutes second part of your treatment.

When your treatments are complete, press the Power Button on the Controller Cable to turn your device off. Store in a safe place for your next treatment.

NOTE – Your HairMax Laser Device cannot be used while being charged.



ATTENTION

The HairMax Laser Device must be plugged into the Battery Pack in order to operate.

ONLY UTILIZE THE PROVIDED BATTERY PACK WITH YOUR HAIRMAX LASER DEVICE. PLUGGING INTO ANY OTHER POWER SOURCE MAY DAMAGE THE DEVICE AND VOID YOUR WARRANTY.

WHAT IS INCLUDED



HairMax
Laser Cap 80 with
Controller Cable



Power Supply
& Cord



Storage/Travel Case



Battery Pack



User Manual

Notice: Entire HairMax assembly is considered as a Type BF applied part.

TROUBLESHOOTING

ANY ATTEMPT TO SELF-SERVICE YOUR DEVICE, UNLESS AS INSTRUCTED BY LEXINGTON INTERNATIONAL CUSTOMER SERVICE, WILL VOID YOUR WARRANTY.

Your HairMax Laser Device has advanced electronics to ensure that the device is working like it is supposed to and that the proper amount of laser energy is being delivered. If for some reason you are experiencing difficulties with your device, please try one of the tips below:

Your laser device will not turn on

- Make sure your HairMax Laser Device is fully charged
- Make sure the laser device and the Battery Pack are properly connected

Your laser device is turning off during use

- Make sure your HairMax Laser Device is fully charged
- Make sure the laser device and the Battery Pack are properly connected

Your laser device is not lighting up, but the Battery Pack is fully charged

- Contact customer service to determine if we need to send you a replacement unit
- Make sure the controller cable is inserted completely into the USB socket on the battery pack.

Your Battery Pack does not show the blue indicators

- Contact customer service to request a replacement Battery Pack

If you have trouble understanding any of these instructions, contact customer service toll-free at the numbers provided below.

Corporate Office – Customer Service – Warranty Repairs

Lexington Intl., LLC
1040 Holland Drive
Boca Raton, Florida 33487 USA

Direct line +1 561-417-0200

United States and Canada 1-866-527-3726

United Kingdom 0808-134-9868

Australia +61 7 3198 2484

Monday - Friday 9 AM - 5 PM ET

Maintenance

Your HairMax Laser Device is designed to last for many years. It does not require any maintenance other than periodic cleaning.

Cleaning your HairMax Laser Device

- Turn off the HairMax Laser Device by pressing the Power Button.
- Disconnect the Power Cord from the Battery Pack.
- Clean your device with a soft, slightly moistened cloth before and after each treatment.

Disposal Instructions



This symbol on the product or on its packaging indicates that this product must not be disposed of with your other household waste. Instead, it is your responsibility to dispose of your waste equipment by handing it over to a designated collection point for the recycling of waste electrical and electronic equipment. The separate collection and recycling of your waste equipment at the time of disposal will help to conserve natural resources and ensure that it is recycled in a manner that protects human health and the environment. For more information about where you can drop off your waste equipment for recycling, please contact your local city office or your household waste disposal service.



Warning label

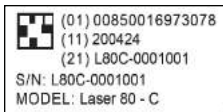

Serial number
(on the back side of
the laser device)

Power Supply Specifications

Output = 5V DC -1.0 A

The power supply for the HairMax Laser Device can be used in the United States and Internationally. This power supply will adapt to all power supplies from 100 volt/60 cycle (US) to 240 volt/50 cycle. If outlets in your country have different plugs than the power supply that comes with the HairMax, use an international plug adapter (not supplied with the device).

LASER PARAMETERS USE CONDITIONS	
Wavelength:	655nm +/- 10nm visible red light
Laser Power for classification:	<5mW CW
Divergence:	57 mrad
Number of lasers:	80
This Laser Product is designated as Class 3R during all procedures of operation.	
Note: HairMax laser devices have no user-serviceable parts.	
Warning label location:	on the back side of the laser device
Laser MTBF: mean time between failures:	10,000 hours at 25°C ambient temperature
Operating temperature/altitude/atmospheric pressure/humidity:	5°C to 35°C/0 to 2,000 m/80kPa to 106kPa/ 0% to 90%, relative humidity
Storage & transportation temperature/humidity/atmospheric pressure:	-20°C to 60° C / 0% to 90%, relative humidity/ 50kPa to 106kPa
Ingress of water or particulate matter:	IP22
Battery charging cycles:	300 cycles
ROHS: restriction of hazardous substances:	2011/65/EU
Device size and weight:	8.5 x 6.5 x 4.5 in/1.3 lb
Product Warranty	2 Years
Age of Use	Adult

Electrical Safety

Basic safety precautions should be observed when using this, or any other electrical device, especially when children are present.

⚠ WARNING: Keep away from water. Contact with water may result in an electrical shock.

To reduce the risk of hazard by electric shock:

- ⚠ Do not use while bathing.
- ⚠ Do not place or store your HairMax Laser Device where it can fall or be pulled into a tub or sink.
- ⚠ Do not expose your HairMax Laser Device to running water, or drop into water or any other liquid.
- ⚠ If your HairMax Laser Device falls into water, unplug it immediately from the power outlet. If using your HairMax Laser Device near water, the use of an electrical outlet protected by a Ground Fault Circuit Interrupter is recommended.
- ⚠ Do not dispose of your HairMax Laser Device in a fire or store in high temperatures greater than 140°F (60°C).
- ⚠ Do not turn on or use your HairMax Laser Device while it is charging.
- ⚠ Power supply cannot be separated during use. Do not position the equipment in a manner that will make it difficult to plug in or remove the power cord.
- ⚠ If you have any problems with this device, such as setting up, maintaining or using, please contact customer service.
- ⚠ Please report to customer service if any unexpected operation or events occur.
- ⚠ After drop/shock that may cause changes in the performance, please contact customer service.
- ⚠ Be careful, do not put the power cord around your neck, it may cause strangulation.
- ⚠ Keep the device out of the reach of children/pets to avoid inhalation or swallowing of small parts.
- ⚠ Do not use the device if it is damaged in any way. The continuous use of a damaged unit may cause injury, improper results, or serious danger.
- ⚠ The device should be used only with the accessories recommended for use by the manufacturer.
- ⚠ When not in use, store the device with the adapter in a dry room and protect it against extreme moisture, heat, lint, dust and direct sunlight.
- ⚠ Never place any heavy objects on the storage case.

Guidance and manufacturer's declaration – electromagnetic emission – for all EQUIPMENT AND SYSTEMS

The HairMax Laser Device is intended for use in the electromagnetic environment specified below. The customer or the user of the HairMax Laser Device should assure that it is used in such an environment.

Emission test	Compliance	Electromagnetic environment-guidance
RF emissions CISPR 11	Group 1	The HairMax Laser Device uses RF energy only for its internal function. Therefore, its RF emissions are very low and are not likely to cause any interference in nearby electronic equipment.
RF emissions CISPR 11	Class B	The HairMax Laser Device is suitable for use in all establishments, including domestic establishments and those directly connected to the public low-voltage power supply network that supplies buildings used for domestic purposes.
Harmonic emissions IEC 61000-3-2	Class A	
Voltage fluctuations /flicker emissions IEC 61000-3-3	Complies	

ELECTROMAGNETIC IMMUNITY GUIDANCE

Guidance and manufacturer's declaration-electromagnetic immunity

The HairMax Laser Device is intended for use in the electromagnetic environment specified below. The customer or the user of the HairMax Laser Device should assure that it is used in such an environment.

Immunity test	IEC 60601 test level	Compliance level	Electromagnetic environment-guidance
Electrostatic discharge (ESD) IEC 61000-4-2	± 8 kV contact ± 15 kV air	± 8 kV contact ± 15 kV air	Floors should be wood, concrete or ceramic tile. If floors are covered with synthetic material, the relative humidity should be at least 30%.
Electrical fast transient/ burst IEC 61000-4-4	± 2kV for power supply lines ± 1kV for input/output lines	± 2kV for power supply lines	Mains power quality should be that of a typical commercial or hospital environment.
Surge IEC 61000-4-5	± 1kV differential mode ± 2kV common mode	± 1kV differential mode ± 2kV common mode	Mains power quality should be that of a typical commercial or hospital environment.
Voltage Dips, short interruptions and voltage variations on power supply input lines IEC 61000-4-11	0% UT; 0,5 cycle g) At 0°, 45°, 90°, 135°,180°, 225°, 270°, and 315° 0% UT; 1 cycle and 70% UT; 25/30 cycles Single phase: at 0° 0% UT; 250/300 cycle	0% UT; 0,5 cycle g) At 0°, 45°, 90°, 135°,180°, 225°, 270°, and 315° 0% UT; 1 cycle and 70% UT; 25/30 cycles Single phase: at 0° 0% UT; 250/300 cycle	Mains power quality should be that of a typical commercial or hospital environment. If the user of the HairMax Laser Device requires continued operation during power mains interruptions, it is recommended that the HairMax Laser Device be powered from an interruptible power supply or a battery.
Power frequency (50, 60 Hz) magnetic field IEC 61000-4-8	3 A/m	3 A/m	Power frequency magnetic fields should be at levels characteristic of a typical location in a typical commercial or hospital environment.

NOTE UT is the a.c. mains voltage prior to application of the test level.

ELECTROMAGNETIC IMMUNITY GUIDANCE

Guidance and manufacturer's declaration – electromagnetic immunity – for EQUIPMENT and SYSTEM that are not LIFE-SUPPORTING

The HairMax Laser Device is intended for use in the electromagnetic environment specified below. The customer or the user of the HairMax Laser Device should assure that it is used in such an environment.

Immunity Test	IEC 60601 Test Level	Compliance Level	Electromagnetic Environment-Guidance
Conducted RF IEC 61000-4-6 Radiated RF IEC 61000-4-3	3 Vrms 150 KHz to 80 MHz 6 V in ISM and amateur radio bands between 0,15 MHz and 80 MHz 10 V/m 80 MHz to 2.7 GHz	3 V 6 V 10 V/m	Portable and mobile RF communications equipment should be used no closer to any part of the HairMax Laser Device including cables, than the recommended separation distance calculated from the equation applicable to the frequency of the transmitter. Recommended separation distance: $d = \left[\frac{3.5}{V_1} \right] \sqrt{P}$ $d = \left[\frac{-12}{V_2} \right] \sqrt{P}$ $d = \left[\frac{3.5}{E_1} \right] \sqrt{P} \quad 80 \text{ MHz to } 800 \text{ MHz}$ $d = \left[\frac{7}{E_1} \right] \sqrt{P} \quad 80 \text{ MHz to } 2,7 \text{ GHz}$ Where P is the maximum output power rating of the transmitter in watts (W) according to the transmitter manufacturer and d is the recommended separation distance in meters (m). ^b Field strengths from fixed RF transmitters, as determined by an electromagnetic site survey, ^a should be less than the compliance level in each frequency range. ^b Interference may occur in the vicinity of equipment marked with the following symbol: 

NOTE1 At 80 MHz and 800 MHz, the higher frequency range applies.

NOTE2 These guidelines may not apply in all situations. Electromagnetic propagation is affected by absorption and reflection from structures, objects and people.

- a The ISM (industrial, scientific and medical) bands between 150 kHz and 80 MHz are 6,765 MHz to 6,765 MHz to 6,795 MHz, 13,553 MHz to 13,567MHz; 26,957 MHz to 27,283 MHz; and 40,70 MHz. The amateur radio bands between 0,15 HMz and 80 MHz are 1,8 HMz to 2,0 HMz, 3,5 MHz to 4,0 MHz, 5,3 MHz to 5,4 MHz, 7 MHz to 7,3MHz, 10,1 MHz to 10,15 MHz, 14 MHz to 14,2 HMz, 18,07 MHz to 18,17 MHz, 21,0 MHz to 21,0 MHz to 21,4 MHz, 24,89 MHz to 24,99 MHz, 28,0 MHz to 29,7 MHz and 50,0 MHz to 54,0 MHz.
- b Field strength from fixed transmitters, such as base stations for radio (cellular/cordless) telephone and land mobile radios, amateur radio, AM and FM radio broadcast and TV broadcast cannot be predicted theoretically with accuracy. To assess the electromagnetic environment due to fixed RF transmitters, an electromagnetic site survey should be considered. If the measured field strength in the location in which the HairMax Laser 272 is used exceeds the applicable RF compliance level above, the HairMax Laser 272 should be observed to verify normal operation. If abnormal performance is observed, additional measures may be necessary, such as reorienting or relocating the HairMax Laser 272.
- c Over the frequency range 150 kHz to 80 MHz, field strengths should be less than 3V/m.

ELECTROMAGNETIC DISTANCE RECOMMENDATIONS

Recommended separation distances between portable and mobile RF communications equipment and the EQUIPMENT or SYSTEM for EQUIPMENT and SYSTEMS that are not LIFE-SUPPORTING

The HairMax Laser Device is intended for use in an electromagnetic environment in which radiated RF disturbances are controlled. The customer or the user of the HairMax Laser Device can help prevent electromagnetic interference by maintaining a minimum distance between portable and mobile RF communications equipment (transmitters) and the HairMax Laser Device as recommended below, according to the maximum output power of the communications equipment.

Rated maximum output power of transmitter (W)	Separation distance according to frequency of transmitter (m)			
	150 kHz to 80 MHz outside ISM and amateur radio bands $d = [\frac{3.5}{V_t}] \sqrt{P}$	150 kHz to 80 MHz outside ISM and amateur radio bands $d = [\frac{12}{V_2}] \sqrt{P}$	80 MHz to 800 MHz $d = [\frac{3.5}{E_1}] \sqrt{P}$	800 MHz to 2.7 GHz $d = [\frac{7}{E_1}] \sqrt{P}$
0.01	0.12	0.20	0.035	0.07
0.1	0.38	0.63	0.11	0.22
1	1.2	2.0	0.35	0.70
10	3.8	6.32	1.10	2.21
100	12	20.00	35	70

For transmitters rated at a maximum output power not listed above, the recommended separation distance d in meters (m) can be estimated using the equation applicable to the frequency of the transmitter, where P is the maximum output power rating of the transmitter in watts (W) according to the transmitter manufacturer.

NOTE1 At 80 MHz and 800 MHz, the separation distance for the higher frequency range applies.

NOTE2 These guidelines may not apply in all situations. Electromagnetic propagation is affected by absorption and reflection from structures, objects and people.

WARRANTY

ANY ATTEMPT TO SELF-SERVICE YOUR DEVICE, UNLESS AS INSTRUCTED BY LEXINGTON INTERNATIONAL CUSTOMER SERVICE, WILL VOID YOUR WARRANTY.

THE HAIRMAX® (HAIRMAX) IS WARRANTED BY LEXINGTON INTERNATIONAL, LLC AGAINST DEFECTS IN MATERIALS OR WORKMANSHIP. PLEASE SEE THE WEBSITE FOR DETAILS OF THE WARRANTY PERIOD. IF THIS PRODUCT IS DETERMINED TO BE DEFECTIVE, LEXINGTON WILL REPAIR OR REPLACE IT, AT ITS OPTION, AT NO CHARGE DURING THE WARRANTY PERIOD.

AFTER THE WARRANTY PERIOD, THE USER MUST PAY FOR ALL PARTS AND LABOR CHARGES. IF THE PRODUCT IS REPAIRED OR REPLACED, EITHER WITHIN OR OUTSIDE THE WARRANTY PERIOD, LEXINGTON RESERVES THE RIGHT TO PROVIDE EQUIVALENT PARTS IN DIFFERENT COLORS TO YOUR ORIGINAL PRODUCT.

THIS WARRANTY DOES NOT COVER DAMAGES CAUSED BY ACTS OF GOD, MISUSE, NEGLIGENCE, ACCIDENT, MODIFICATION OF, OR TO ANY PART OF THE PRODUCT. THIS WARRANTY DOES NOT COVER DAMAGE DUE TO IMPROPER OPERATION OR MAINTENANCE, CONNECTION TO IMPROPER VOLTAGE SUPPLY, OR ATTEMPTED REPAIR BY ANYONE OTHER THAN LEXINGTON. THIS WARRANTY IS VOID IF PRODUCT IS TAMPHERED WITH.

TO OBTAIN WARRANTY SERVICE, YOU MUST CALL HAIRMAX CUSTOMER SERVICE TO REQUEST AN AUTHORIZATION NUMBER. YOU MUST DELIVER THE PRODUCT FREIGHT PREPAID, IN EITHER ITS ORIGINAL PACKAGING OR PACKAGING AFFORDING AN EQUAL DEGREE OF PROTECTION, TOGETHER WITH YOUR NAME AND ADDRESS, TO:

Lexington International, LLC, 1040 Holland Drive, Boca Raton, FL 33487, USA

LIMITATION OF LIABILITY; INDEMNITY: EXCEPT AS EXPRESSLY SET FORTH ABOVE, LEXINGTON INTERNATIONAL, LLC SHALL NOT BE LIABLE FOR ANY SPECIAL, INDIRECT, OR CONSEQUENTIAL DAMAGES THAT ARE DIRECTLY OR INDIRECTLY RELATED TO THE USE OF, OR THE INABILITY TO USE, THE HAIRMAX, EVEN IF LEXINGTON INTERNATIONAL, LLC HAS BEEN ADVISED OF THE POSSIBILITY OF SUCH DAMAGES WHETHER IN AN ACTION OF CONTRACT, NEGLIGENCE OR OTHER TORTUOUS ACTION. SOME STATES DO NOT ALLOW THE EXCLUSION OR LIMITATION OF INCIDENTAL OR CONSEQUENTIAL DAMAGES, SO THE ABOVE LIMITATION OR EXCLUSION MAY NOT APPLY TO YOU.

GOVERNING LAW: THE USAGE OF THE HAIRMAX AND THE INTERPRETATION OF THE TERMS OF THIS AGREEMENT SHALL BE GOVERNED BY AND CONSTRUED IN ACCORDANCE WITH THE LAWS OF THE STATE OF FLORIDA APPLICABLE TO AGREEMENTS NEGOTIATED, EXECUTED AND PERFORMED WHOLLY AND SOLELY WITHIN THE STATE OF FLORIDA. THE PARTIES AGREE THAT THE STATE OF FLORIDA'S CONFLICTS OF LAWS RULES SHALL NOT APPLY TO THIS AGREEMENT OR ANY TRANSACTION PERFORMED BY OR UNDER THIS AGREEMENT.

JURISDICTION AND VENUE: THE PARTIES IRREVOCABLY SUBMIT AND CONSENT TO THE SOLE AND EXCLUSIVE JURISDICTION AND VENUE OF THE FLORIDA STATE COURTS IN AND FOR PALM BEACH COUNTY, FLORIDA, U.S.A. AND THE FEDERAL COURTS IN AND FOR THE SOUTHERN DISTRICT OF FLORIDA, U.S.A. THE PARTIES AGREE NOT TO RAISE THE DEFENSE OF FORUM NON CONVENIENS.

AUTHORIZED REPRESENTATIVE IN EUROPE (REGULATORY AFFAIRS ONLY): EMERGO EUROPE, PRINSESSEGRACHT 20, 2514 AP THE HAGUE, THE NETHERLANDS.
TEL: +31 (0) 70 345-8570. FAX: +31 70 346-7299

To validate your warranty please register online at www.hairmax.com/warranty

WARRANTY

Your HairMax device has 2 year warranty against defects in materials or workmanship from Lexington International, LLC. Items that are damaged or abused are not covered under the warranty and will be charged at their regular repair rates. Any attempt to self-service your device, unless instructed by LEXINGTON INTERNATIONAL CUSTOMER SERVICE, will void your warranty. Please refer to our website for complete warranty terms.

To validate your warranty, register online at
www.hairmax.com/warranty

If you do not have a computer you can register by phone at the following numbers:

Direct line +1 561-417-0200

United States and Canada 1-866-527-3726

United Kingdom 0808-134-9868

Australia +61 7 3198 2484

Monday - Friday 9AM - 5PM ET

Corporate Office – Customer Service – Warranty Repairs

Lexington Intl., LLC
1040 Holland Drive
Boca Raton, Florida 33487 USA

Direct line +1 561-417-0200

United States and Canada 1-866-527-3726

United Kingdom 0808-134-9868

Australia +61 7 3198 2484

Monday - Friday 9 AM - 5 PM ET

Authorized Representative in Europe (Regulatory Affairs Only):



Tel: +31 (0) 70 345-8570 Fax: +31 70-345-7299

Australian Sponsor: Emergo Australia
Level 20, Tower II Darling Park, 201 Sussex Street
Sydney, NSW 2000 Australia

HAIRMAX[®]

The science of hair growth.[®]

