

Lucca Steel Leaf Gazebo

Assembly Instructions -Please keep for future reference

917056

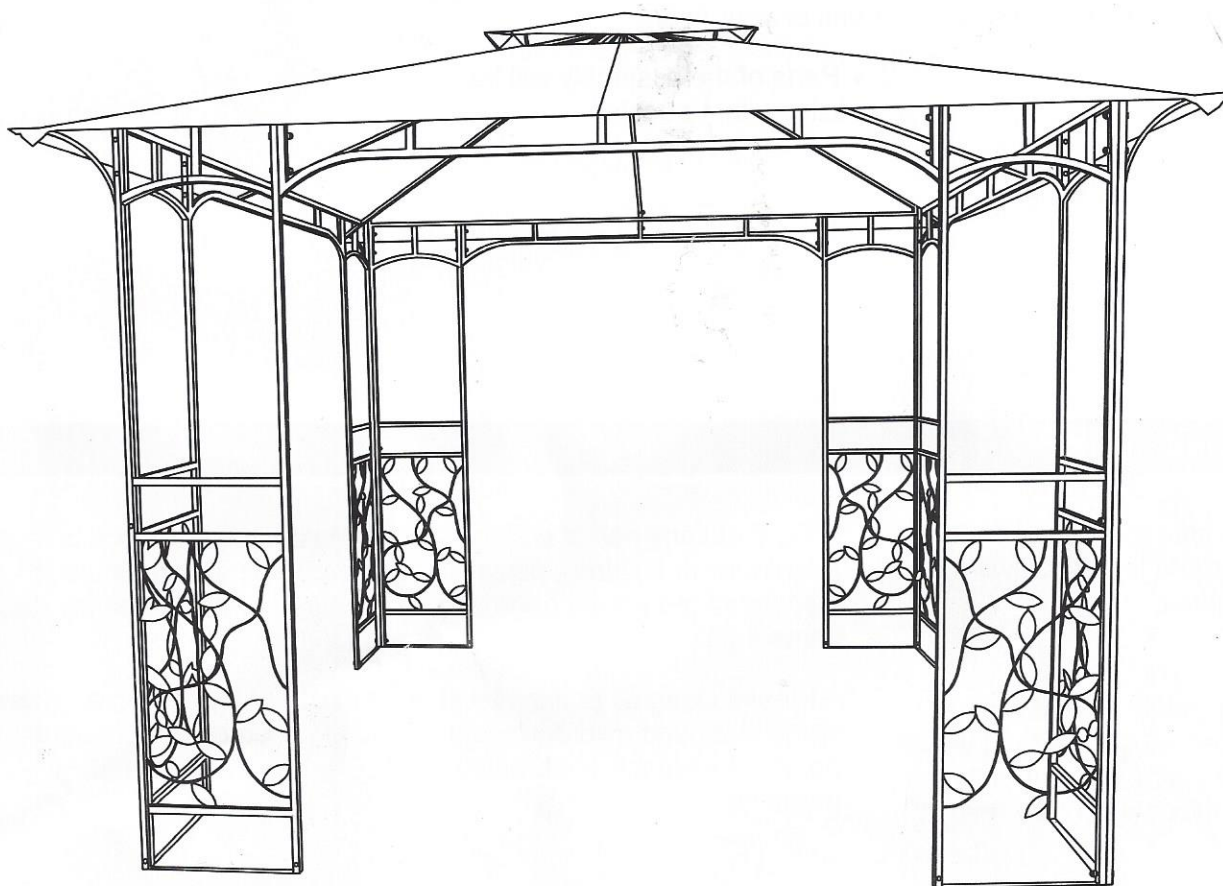

Dimensions

Length- 300cm

Width - 300cm

Height - 266cm

Important Please read these instructions fully before starting assembly

If you need help or have damaged or missing parts, call the **Customer Helpline: 084 5077 8888**

Safety and Care Advice

Important Please read these instructions fully before starting assembly

- Check you have all the components and tools listed on page 2.
- Remove all fittings from the plastic bags and separate them in to their groups.
- Keep children and animals away from the work area, small parts could choke if swallowed.
- Make sure you have enough space to layout the parts before starting.
- Do not stand or put weight on the product during assembly, this could cause damage.
- Assemble on a soft level surface to avoid damaging the unit or your floor.
- Parts of the assembly will be easier with 4 people.
- We do not recommend the use of power drill/drivers for inserting screws, as this could damage the unit.
Only use hand screwdrivers.
- Dispose of all packaging carefully and responsibly.



Care and maintenance

- From time to time check that there are no loose screws on this product.
- To avoid any risk of suffocation to animals or children, please dispose of the plastic bags immediately.
- Make sure each screw matches the corresponding figure to ensure correct assembly.
- This product should not be discarded with household waste. Take to your local authority waste disposal centre.
- Please clean all surfaces with a damp cloth and mild detergent, do not use bleach or abrasive products.
- Do not fully tighten all screws until assembly is complete.

Safety during use

- This gazebo features a fabric cover that is not fire retardant and we recommend caution and sense when in use.
- Do not repack your gazebo until it is completely dry.
- Do not use naked flames in or around the gazebo. We recommend you do not smoke in or around this product. There is no flame retardant cooking area and should not be use to house BBQ's.
- THIS GAZEBO CAN BURN.
- This gazebo is not a permanent structure and should be disassembled and stored away after use.
- This gazebo is not waterproof (if applicable)
- Do not erect in high wind.

Components - Parts

Please check you have all the parts listed below

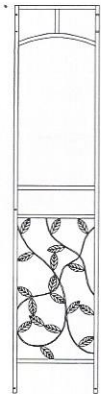

1 Panel x 4

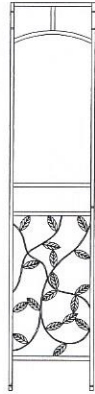

2 Panel x 4



3a Corner Rib x 4

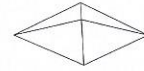

7 Center Fabric x 1

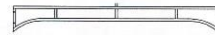

3b Crossbeam x 4

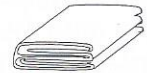

8 Top Fabric x 1



4 Middle Rib x 4



5 Center Contractor x 1



6 Base x 4









9 Corner Fitting x 4

Components - Fittings

If you have damaged or missing components, call the **Customer Helpline: 084 5077 8888**

Please check you have all the fittings listed below.

Note: The quantities below are the correct amount to complete the assembly
In some cases more fittings may be supplied than are required.

<p>A  </p> <p>Screw x 32 M6x52mm</p>	<p>B  </p> <p>Screw x 8 M6x32mm</p>	<p>C  </p> <p>Screw x 4 M6x 28mm</p>
<p>D </p> <p>Peg x 16</p>		

Tools required



Allen Key x 1

Ruler - Use this ruler to help correctly identify the screws



Assembly Instructions

Step 1

Assembly corner panel

a. Lay out all panels **1** and **2** and combine panels **1** and **2** to form each corner section. Please ensure that all holes line up on **1** and **2** as shown in the line drawing then join using screw **A**.

b. Put the fixed corner panel onto the base **6** using screw **B**. Repeat a and b to finish another 3 corner panels.

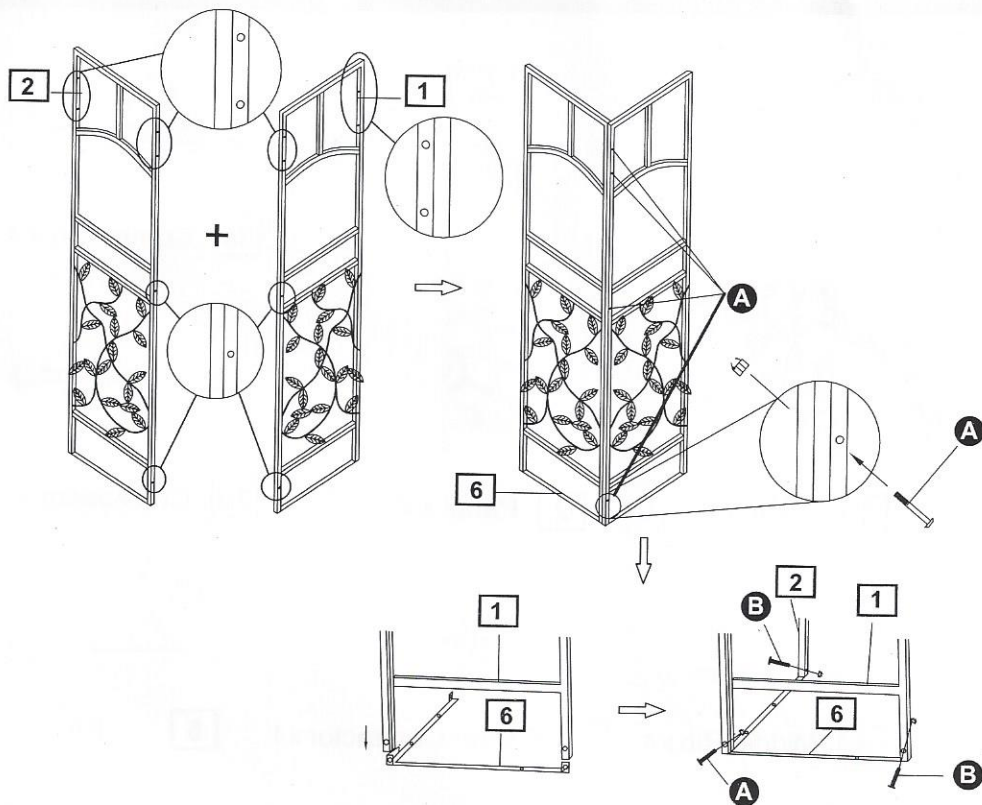

Step 2

Fitting bolts

Attach crossbeam **3b** to the corner panels using screw **A**.

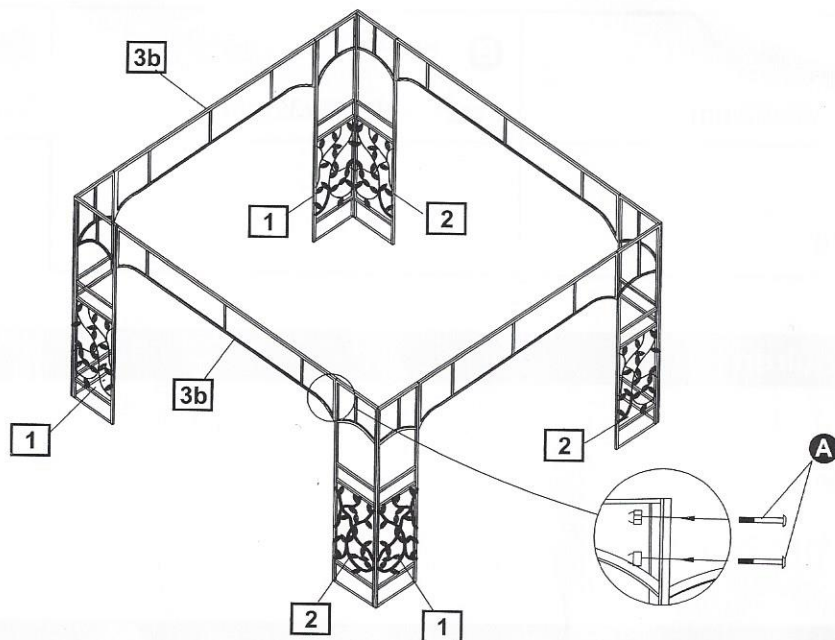

Assembly Instructions

Step 3

a. Insert the corner rib **3a** into the long tube of roof center contractor **5**, and insert middle rib **4** into the short tube of **5**.

b. Attach corner fittings **9** to corner rib **3a**

Note: It's best to cooperate with 4 people at ground

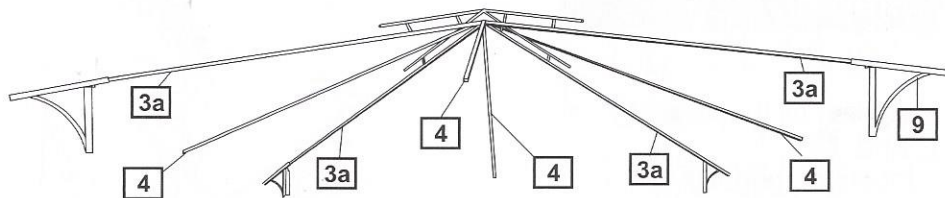
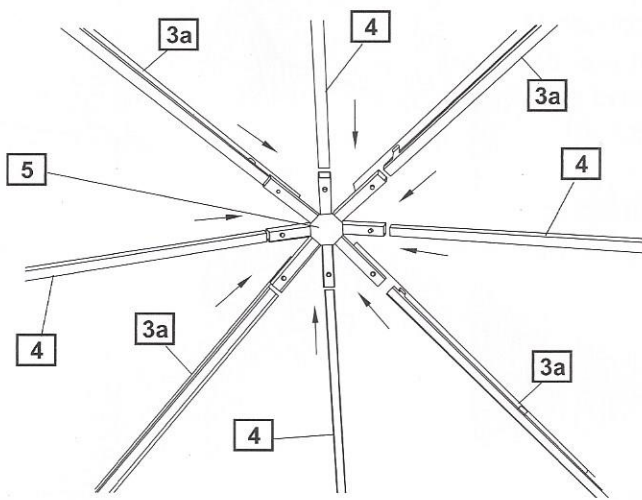

Assembly Instructions

Step 4

a. Put the top fabric **8** onto the frame. Finish the 3 corner of roof first, then pull the fabric tightly and cover into the last corner.

b. Then put another center fabric onto the top.

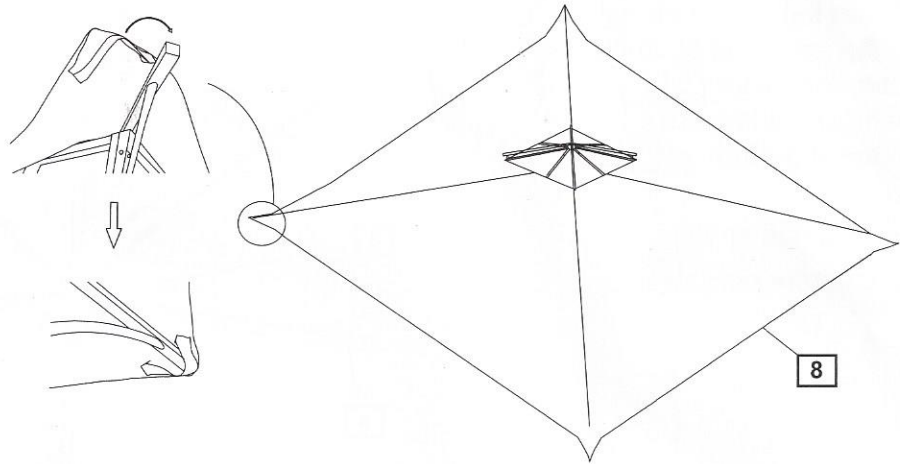

Step 5

Lift the gazebo roof frame up with 4 people and secure on the four corner panels.

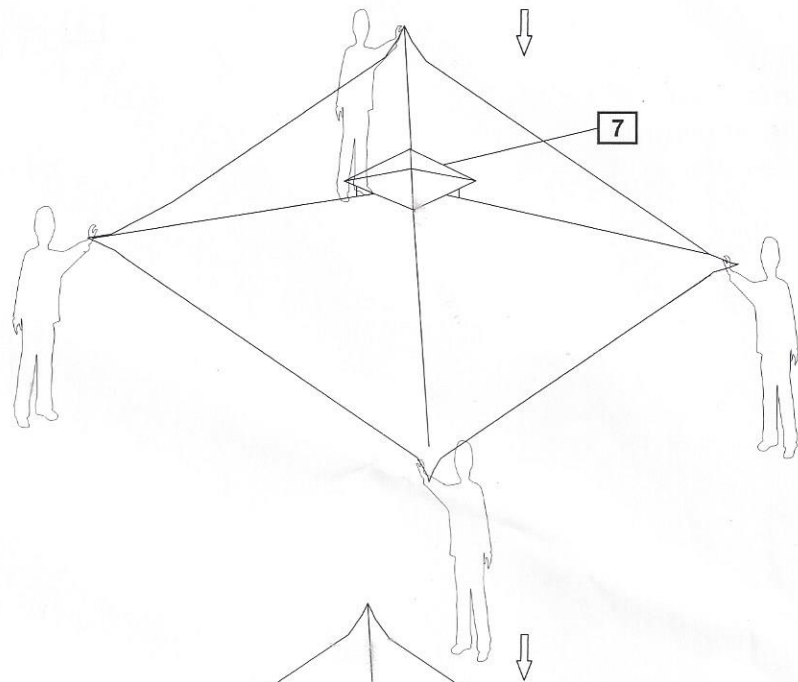

Step 6

Tighten all the screw **C** and **A**.
Insert the peg **D** through the hole of base into the ground.

Assembly is complete.

