







  
**DIAMONDBACK**





**PROTECT YOUR GEAR**  
**WITH THE TOUGHEST, MOST SECURE,**  
*Truck Bed Cover.*





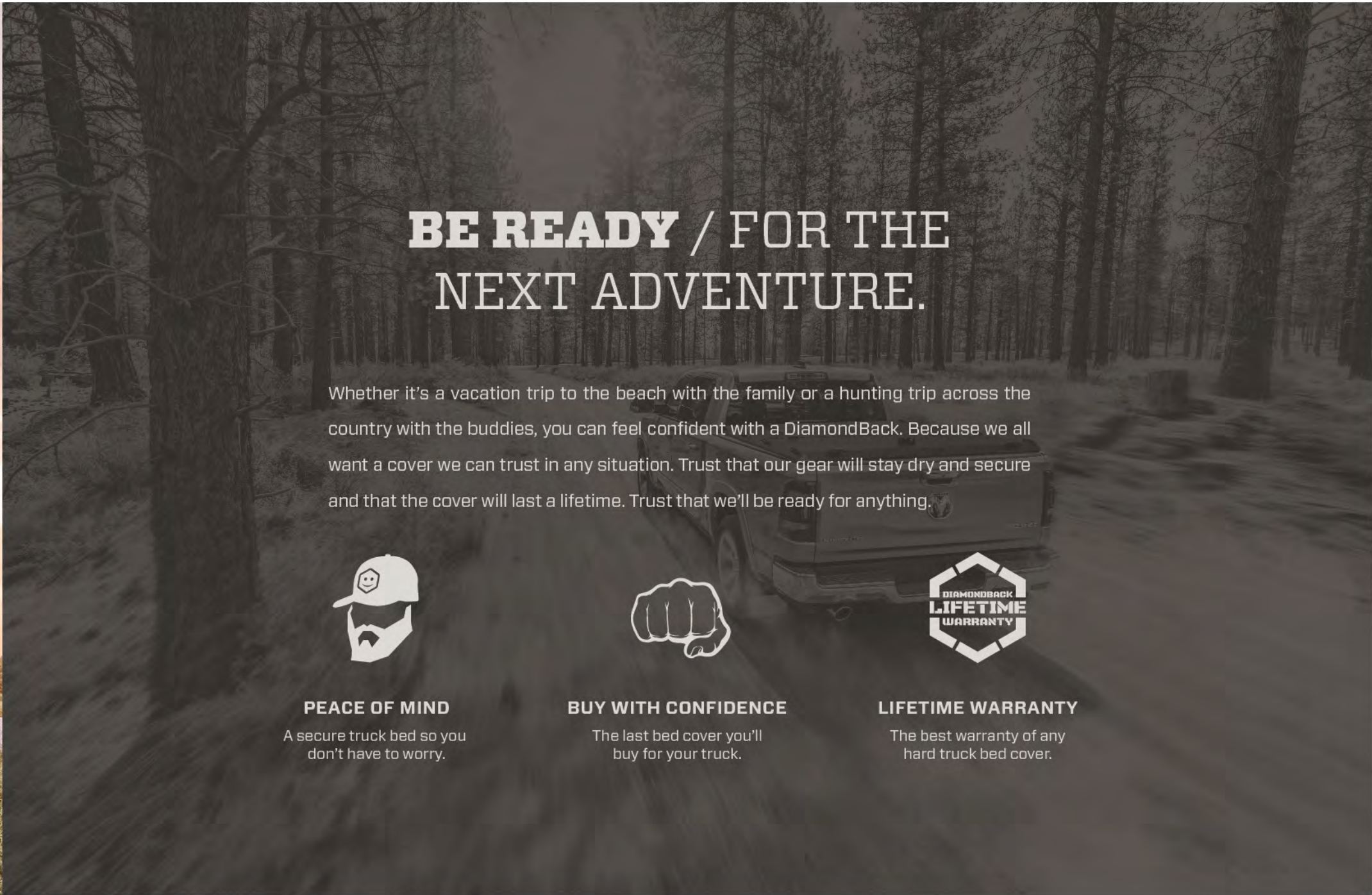

# BE READY / FOR THE NEXT ADVENTURE.

Whether it's a vacation trip to the beach with the family or a hunting trip across the country with the buddies, you can feel confident with a DiamondBack. Because we all want a cover we can trust in any situation. Trust that our gear will stay dry and secure and that the cover will last a lifetime. Trust that we'll be ready for anything.



## PEACE OF MIND

A secure truck bed so you don't have to worry.

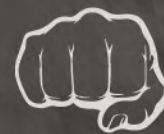

## BUY WITH CONFIDENCE

The last bed cover you'll buy for your truck.



## LIFETIME WARRANTY

The best warranty of any hard truck bed cover.





## **DRY GEAR / NO MATTER WHAT THE WEATHERMAN SAYS.**

A thick neoprene compression gasket runs along the perimeter of the cover to create a barrier to water, snow, or ice, keeping your cargo dry.

- Neoprene perimeter gasket
- Gutter-protected hinge points
- Side-facing key cylinders
- Stainless exterior hardware

## **WE B / ARC**

Rugged, die-  
of a Diamond  
3/8" deadbo  
your truck.

- Deadbol
- Die-cast
- 2 key loc
- Tight an





## WE BUILT EVERYTHING / **AROUND SECURITY.**

Rugged, die-cast zinc lock handles on the access panels of a DiamondBack keep your gear secure by actuating 3/8" deadbolt-style rods directly under the bed rails of your truck.

- **Deadbolt-style lock system**
- **Die-cast zinc lock handles**
- **2 key locks**
- **Tight and secure fit**





## START CAL

With a 1600-lb hauling  
It's built really, really s

- Haul up to 1,600 l
- 12 anchor cleats p
- Heavy duty diamo
- Structural suppor





# DIAMONDBACK<sup>HD</sup>

## A workhorse so you don't have to be.

For all of those that want a truck bed cover for work or play, the DiamondBack HD is the top-of-the-line heavy duty cover that helps you do more with your truck. Perfect for truck-owning avid sportsmen, outdoor enthusiasts, and weekend project warriors.

Haul Capacity  
**1,600 LBS**

Cleats Installed  
**12**

Max Panel Weight  
**50 LBS**

Finish Options:  Rugged Black  Aluminum

## START CALLING IT A **HONEY-DONE LIST.**

With a 1600-lb hauling capacity, where there's a DiamondBack HD, there's a way. It's built really, really strong making it the most capable hard truck bed cover ever.

- Haul up to 1,600 lbs. on top
- 12 anchor cleats pre-installed
- Heavy duty diamond plate aluminum
- Structural support members







## ALWAYS R

Made from aluminum  
fiberglass or wear out  
outdoors in new ways

- Haul up to 400 lb
- 4 anchor cleats p
- Heavy duty diamo
- Structural support



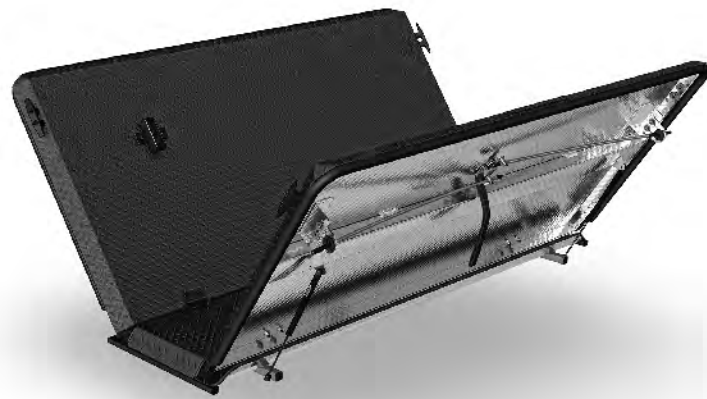

# DIAMONDBACK<sup>SE</sup>

## The new standard in hard truck bed covers.

A durable, versatile, locking truck bed cover that's perfect for the truck owner that likes to use their truck like a truck. The DiamondBack SE is designed for people who want convenience. Now you can haul the unexpected, while keeping those everyday items in your bed.

Haul Capacity  
**400 LBS**

Cleats Installed  
**4**

Max Panel Weight  
**35 LBS**

Finish Options:  Rugged Black  Aluminum

## ALWAYS READY **TO EXPLORE.**

Made from aluminum diamond plate, the DiamondBack SE truck bed cover won't crack like fiberglass or wear out like vinyl. With a 400 lb. hauling capacity, you can conquer the outdoors in new ways while keeping your gear dry and secure in the bed of your truck.

- Haul up to 400 lbs. on top
- 4 anchor cleats pre-installed
- Heavy duty diamond plate aluminum
- Structural support members





270



## STILL PLAY YOUR GEAR

Three large access panels on the truck. You paid for your truck. You paid for your gear. Optional storage bins underneath.

- Gull-wing access
- Unique three-hat
- Optional storage





## DIAMONDBACK270

### Toolbox up front. Truck cover in the back.

The DiamondBack 270 offers a combination of versatility, security, and easy access that's second to none. It's part toolbox and part truck bed cover. Getting into your truck bed will never be the same, because now you can have all the access you've ever wanted.

Haul Capacity  
**400 LBS**

Cleats Installed  
**0**

Max Panel Weight  
**35 LBS**

Finish Options:  Rugged Black  Aluminum

### STILL PLAYING HIDE AND SEEK WITH YOUR GEAR? **GAME OVER.**

Three large access panels make for easy access to all your cargo all the way around your truck. You paid for your whole bed, so you should be able to access it all too. Optional storage bins underneath the gull-wing doors keep you and your things organized.

- Gull-wing access panels up front
- Unique three-hatch design
- Optional storage bins







180

## FINALLY R

With butterfly doors th  
open access to your e  
underneath the acces

- Two near full-length
- Butterfly-style de
- Optional storage





## DIAMONDBACK180

### Moves like a butterfly. Works like a bee.

With two near full-length, side-opening panels, you now have complete open access to your entire bed from both sides of the DiamondBack 180. This means you can work and play directly out of your truck without having to crawl into the bed to reach stuff.

Haul Capacity  
**400 LBS**

Cleats Installed  
**0**

Max Panel Weight  
**40 LBS**

Finish Options:  Rugged Black  Aluminum

### FINALLY REACH INTO YOUR **ENTIRE BED.**

With butterfly doors that run the length of your truck bed, you now have complete open access to your entire bed from both sides of your truck. Optional storage bins underneath the access panels keep you and your things organized.

- Two near full-length, side opening panels
- Butterfly-style design
- Optional storage bins







GO WHERE NO TRUCK  
HAS **GONE BEFORE**

With the DiamondBack AT  
can say goodbye to the ad  
expense of buying a trailer  
keeping it registered, main  
and stored.





## DIAMONDBACK **ATVS**

### **The most versatile ATV hauler.**

For those that want to haul up to 2 ATVs, this ATV carrier includes the DiamondBack HD, 12' folding aluminum ramps, side adapter bars and removable side rails. Optional extension deck (for 6'-6'11" beds) available to turn a standard bed into a long bed truck.

Finish Options:  Rugged Black  Aluminum

### **GO WHERE NO TRAILER HAS GONE BEFORE.**

With the DiamondBack ATVS you can say goodbye to the added expense of buying a trailer and keeping it registered, maintained, and stored.



### **FREE UP YOUR HITCH.**

Forget about having to make those hard decisions on what to take. Whether that be more ATVs, a boat, or a camper now you can haul it all with one truck.







GO WHERE NO TRUCK  
HAS **GONE BEFORE**

With the DiamondBack AT  
can say goodbye to the ad  
expense of buying a trailer  
keeping it registered, main  
and stored.



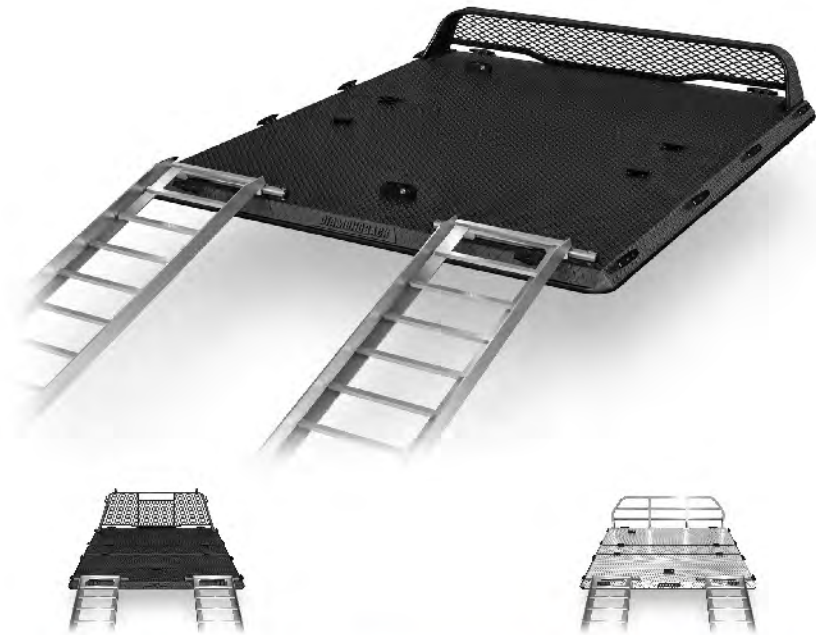

# DIAMONDBACK **ATVR**

## Hauling 1 ATV has never been easier.

Perfect for ATV owners that only need to haul one ATV, this ATV carrier includes the DiamondBack HD, 12' folding aluminum ramps, rear adapter bars and your choice of rear window protection.

Finish Options:  Rugged Black  Aluminum

### Rear Window Protection Options:

HD Cab Guard

Headache Rack

Low-Profile Cab Guard

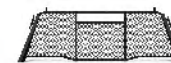

## GO WHERE NO TRAILER HAS **GONE BEFORE.**

With the DiamondBack ATVR you can say goodbye to the added expense of buying a trailer and keeping it registered, maintained, and stored.



## FREE UP **YOUR HITCH.**

Forget about having to make those hard decisions on what to take. Whether that be more ATVs, a boat, or a camper now you can haul it all with one truck.







**PROTECT  
YOUR GEAR.**

Peace of mind is knowing your gear is safe when you're out riding away from your truck while heading to off-road destinations.





# DIAMONDBACK **SXS**

## **A new way to haul your side-by-side.**

Never before have you been able to haul your side-by-side vehicle without a trailer, until now. Haul your side-by-side on top, secure your gear in the bed underneath, and free up your hitch to be able to finally take along that camper, boat, or more off-road vehicles.

Finish Options:  Rugged Black  Aluminum

## **PROTECT YOUR GEAR.**

Peace of mind is knowing your gear is safe when you're out riding or away from your truck while traveling to off-road destinations.



## **LEAVE THE TRAILER BEHIND.**

With the DiamondBack SXS Carrier you can forget about the added expense of buying a trailer and keeping it registered, maintained, and stored.





# DIAMONDBACK **ACCESSORIES**

Get a little more out of your DiamondBack.

## Rear Window Protection

HD Cab Guard



Headache Rack



Low-Profile Cab Guard



## On-Top Hauling

Anchor Cleats



Cover-Mount Rack



## Bed Organization

Side Bin

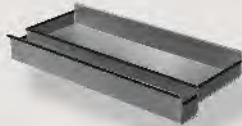

Side Boxes

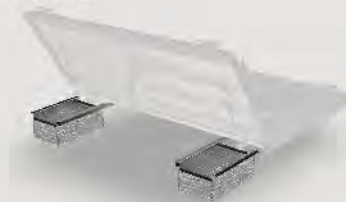

Cross Bin



## DIAMONDBACK

HAUL CAPACITY  
**1,600 LBS**

ACCESS PANELS  
**2**

CLEATS INSTALLED  
**12**

ALUMINUM GRADE  
**.100"**

REMOVAL TIME  
**10 MIN**

TALL CARGO  
**YES**

MAX PANEL WEIGHT  
**50 LBS**

TOTAL WEIGHT  
**125 LBS**



# Compare DiamondBack Models

 Shipped to you door

 Built in the USA

 Lifetime Warranty



## DIAMONDBACK<sup>HD</sup>

 HAUL CAPACITY  
**1,600 LBS**

 ACCESS PANELS  
**2**

 CLEATS INSTALLED  
**12**

 ALUMINUM GRADE  
**.100"**

 REMOVAL TIME  
**10 MIN**

 TALL CARGO  
**YES**

 MAX PANEL WEIGHT  
**50 LBS**

 TOTAL WEIGHT  
**125 LBS**



## DIAMONDBACK<sup>SE</sup>

 HAUL CAPACITY  
**400 LBS**

 ACCESS PANELS  
**2**

 CLEATS INSTALLED  
**4**

 ALUMINUM GRADE  
**.080"**

 REMOVAL TIME  
**10 MIN**

 TALL CARGO  
**YES**

 MAX PANEL WEIGHT  
**35 LBS**

 TOTAL WEIGHT  
**90 LBS**



## DIAMONDBACK<sup>270</sup>

 HAUL CAPACITY  
**400 LBS**

 ACCESS PANELS  
**3**

 CLEATS INSTALLED  
**0**

 ALUMINUM GRADE  
**.080"**

 REMOVAL TIME  
**10 MIN**

 TALL CARGO  
**YES**

 MAX PANEL WEIGHT  
**35 LBS**

 TOTAL WEIGHT  
**110 LBS**



## DIAMONDBACK<sup>180</sup>

 HAUL CAPACITY  
**400 LBS**

 ACCESS PANELS  
**2**

 CLEATS INSTALLED  
**0**

 ALUMINUM GRADE  
**.080"**

 REMOVAL TIME  
**10 MIN**

 TALL CARGO  
**NO**

 MAX PANEL WEIGHT  
**40 LBS**

 TOTAL WEIGHT  
**105 LBS**



## THE BRAINS BEHIND THE BRAWN.

A patented design combining diamond plate aluminum and structural support studs provides the platform for a new way of hauling with your truck.

 US PATENT  
6,883,855

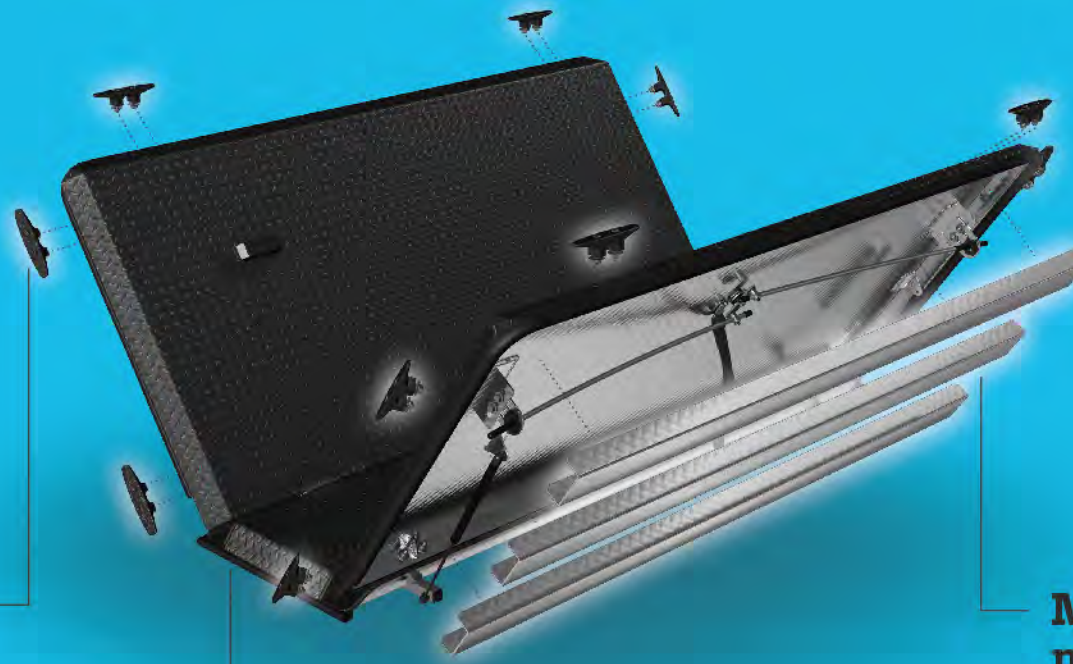

**Load it up.  
Strap it down.**

 High-strength, heavy duty nylon anchor cleat  
1200 lb. tensile strength  
Up to 12 anchor cleats pre-installed

**Our cover has  
thick skin.**

 HD = .100" 3003 alloy aluminum grade  
SE/270/180 = .080" 3003 alloy aluminum grade

**More studs,  
more strength.**

 Haul up to 1,600 lbs

CE

U

At DiamondBack  
up our sleeves  
products that  
have always

Established

1864

Population

2,70



studs,  
strength.

up to 1,600 lbs

*Proudly*  
**CRAFTED**  
*in the*  
**USA**

At DiamondBack, we're a team dedicated to rolling up our sleeves, getting dirty, and building quality products that make a difference. We're proud to have always called Philipsburg, PA our home.

Established

**1864**

Population

**2,708**

