



DIAMONDBACK

DiamondBackCovers.com / 800 935 4002

OWNERS MANUAL

SERIAL NUMBER: _____

IMPORTANT: READ THIS OWNERS MANUAL BEFORE OPERATING YOUR COVER

NOTICE TO INSTALLER

Give this document to the customer to ensure safe operation of DiamondBack products.

WARNING

Failure to properly secure cargo or hauling inappropriate cargo may result in property damage, serious bodily injury, or death.

WARNING

Do not attempt to haul cargo on top of your DiamondBack without reading the Load Securement section on page 8 of this manual.

WARNING

Do not use your DiamondBack if your hinges are damaged.

NOTICE

The installation and use of any rail-mounted accessory may cause minor aesthetic damage to your truck's exterior. See your vehicle manufacturer's specifications for rail-mounted accessories.

REGISTER YOUR DIAMONDBACK

To register your DiamondBack and activate your warranty, visit diamondbackcovers.com/register.

DANGER

Failure to follow the safety notices in this manual may result in property damage, serious bodily injury, or death.

WARNING

General Usage

- Improper installation of your DiamondBack may be dangerous. Please follow the installation guide carefully.
- The installation and use of any rail-mounted accessory may cause minor aesthetic damage to your truck's exterior. See your vehicle manufacturer's specifications for rail-mounted accessories.
- Do not drive your truck without key-locking your DiamondBack's access panels.
- Do not attempt to install or remove your DiamondBack's gas springs without otherwise supporting the access panel.
- Never drive your truck with your DiamondBack's access panels folded unless you have secured the panels with ratchet straps. See the "Folding Access Panels" section on page 7 of this manual for the correct securement procedure.
- The installation and use of any rail-mounted accessory may cause minor aesthetic damage to your truck's exterior. See your vehicle manufacturer's specifications for rail-mounted accessories.
- Do not close your DiamondBack's access panels unless the hinges are fully mated.
- Do not use your DiamondBack if the hinges are damaged. See the "Hinge Instructions" section on page 5 of this manual for hinge replacement instructions.
- Never drive your truck without your DiamondBack's safety catch installed on the driver side of your cab panel.
- Do not use your DiamondBack unless all its parts are in place in accordance with the Installation Guide.
- To avoid lock handle damage, do not let the ends of your lock rods touch the bed wall.

WARNING

Hauling on Top of Your DiamondBack

- Check and, if needed, tighten your cap clamps, lock rod guide brackets and lock rod set screws every time you haul on top of your DiamondBack.
- Do not exceed the distributed load rating of 1600 lbs or two full-size ATVs on top of your DiamondBack HD. Do not exceed the distributed load rating of 400 lbs on top of your DiamondBack SE, DiamondBack 270, or DiamondBack 180.
- The hauling capacity of your DiamondBack applies to your DiamondBack only. Do not exceed your vehicle manufacturer's specified load capacity for rail-mounted accessories.
- Hauling on top of your DiamondBack will raise your truck's center of gravity. Avoid excessive speeds, fast braking, and sudden, sharp turns.
- Do not haul lumber, pipe, or other slender objects on top of your DiamondBack without using a cab guard.
- Secure the cargo on top of your DiamondBack in both the front-to-back and side-to-side directions by using multiple straps.
- Always make sure your ratchet straps are tight before driving with cargo on top of your DiamondBack.
- Do not use bungee cords to secure cargo on top of your DiamondBack.
- Never transport people or animals on top of your DiamondBack.
- Follow the hauling regulations in your state or province. It is the user's responsibility to conform with all laws and DOT regulations in their state or province.
- If the total height of your load exceeds that of your truck cab, know your vertical clearance and take necessary driving precautions.
- Do not rear-load an ATV or SXS without some form of protection for your truck cab's rear window, such as the DiamondBack Headache Rack or Low-Profile Cab Guard.

LIMITED LIFETIME WARRANTY

DiamondBack Automotive Accessories Inc. (DiamondBack) hereby warrants to the *original purchaser* of this DiamondBack, when the Limited Lifetime Warranty is registered, that it will be free of defects in material and workmanship when installed and operated in accordance with the printed instructions accompanying it as follows:

- Aluminum structure: Lifetime
- Gas springs: Lifetime
- Locks and locking mechanisms: Lifetime
- Hinges: Lifetime
- Weatherstrip: Lifetime
- Edge Trim: Lifetime
- Tie-down cleats: Lifetime

Factory-applied coatings are excluded from this Limited Lifetime Warranty. They are covered for three years, with the exceptions of damage caused by abrasion or the hauling of ATVs or SXSs on top.

Spray-on adhesion repair will be provided by DiamondBack or the closest available authorized spray-on dealer at DiamondBack's discretion. Scratch or abrasion repairs are the responsibility of the purchaser and may be serviced at any authorized spray-on location. Spray-on, franchise-applied coatings must be returned to original franchisee for warranty service or repair.

This Limited Lifetime Warranty shall be limited to the repair or replacement of parts that prove defective under normal use and service and which on examination shall indicate, to DiamondBack's satisfaction, they are defective. Before returning any parts, contact a DiamondBack Customer Support Representative using the contact information on our website. If DiamondBack confirms the defect and approves the claim, DiamondBack will elect to replace or repair such parts without charge. If you are required to return defective parts, transportation charges must be prepaid. DiamondBack will return parts to the purchaser when necessary, freight or postage prepaid.

This Limited Lifetime Warranty does not cover any failures or operating difficulties due to accident, abuse, misuse, alteration, misapplication, vandalism, improper installation or improper maintenance or service, or failure to perform normal and routine maintenance, as set out in this owner's manual and does not cover damaged material or structures due to accident or misuse. DiamondBack makes no claims or warranties as to a particular vehicle's ability to support rail mounted accessories without incurring damage.

Deterioration or damage due to severe weather conditions such as hail, hurricanes, earthquakes or tornadoes, discoloration due to exposure to chemicals either directly or in the atmosphere, is not covered by this Limited Lifetime Warranty.

There are no other warranties, express or implied, including the implied warranty of fitness for a specific use. DiamondBack is not liable for any special, indirect or consequential damages.

DiamondBack does not authorize any person or company to assume for it any other obligation or liability in connection with the sale, installation, use, removal, return, or replacement of its equipment; and no such representations are binding on DiamondBack.

DiamondBack may require reasonable proof of your purchase date. Therefore, you should retain your sales slip or invoice.

For replacement parts, please call 800.935.4002 x2 or email support@diamondbackcovers.com.



Customer Support Center
354 Enterprise Drive
Philipsburg, PA 16866
800 935 4002 x2
DiamondBackCovers.com

HINGE INSTRUCTIONS

HINGE CHECK PROCEDURE

WARNING

Check your hinges even if your DiamondBack cover was dealer-installed.

WARNING

Do not use your DiamondBack cover if its hinges are damaged.

 If your hinge are damaged, refer to “Replacing Hinges” on page 5.

1. Verify that each door panel cannot move side to side.

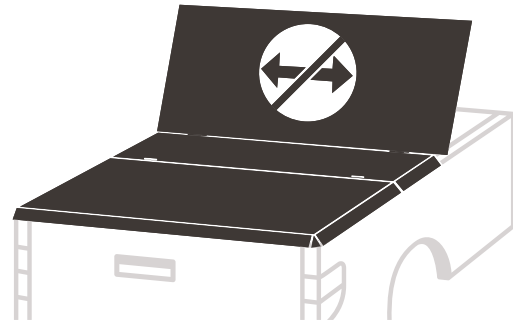

2. Confirm that the hinges are fully mated.

**SLIP JOINT
HINGE**

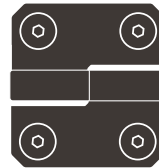

**DROP-ON
HINGE**

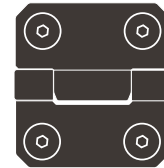

3. Ensure that all three panels line up as you look down the bed rails of your truck.

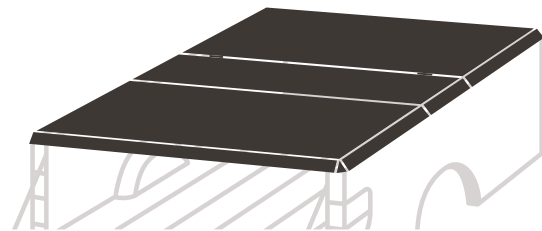

HINGE INSTRUCTIONS

REPLACING HINGES

1. Remove the access panel.

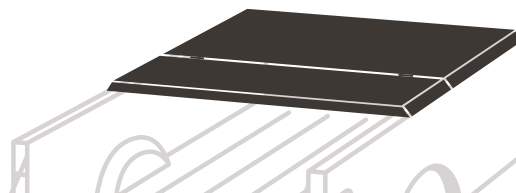

2. Remove the hinge components from both panels using a 3/16" hex key on top and ratchet with 1/2" socket underneath.

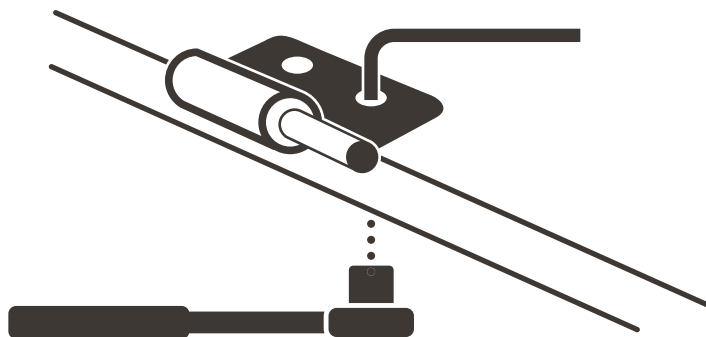

3. Install the new hinge in the same location as the damaged hinge, noting its proper orientation.



ACCESS PANEL



CENTER PANEL



OPERATING INSTRUCTIONS

SAFETY CATCH

The safety catch on your DiamondBack keeps the cab panel from opening more than a third of the way. To open the cab panel all the way, you have to disengage the safety catch.

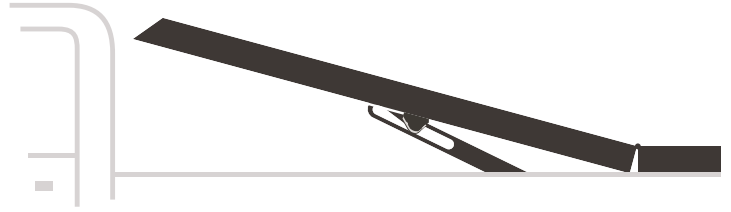

1. Close the cover slightly to take the tension off the safety catch.



2. Push up on the safety catch so its triangle clears the ball stud. Push the cab panel up.



WARNING

Never drive your truck without your DiamondBack's safety catch installed on the driver side of the cab panel. Do not rely on the safety catch alone. Key-lock the cab panel to keep it from blowing open.

GAS SPRINGS

The tops of the gas springs on your DiamondBack are equipped with quick-release ends that let you detach the springs quickly so you can fold back or remove the access panels.

1. Flip the quick-release tab outward to the open position and pull the gas spring off the access panel ball stud.



 **CLOSED**



 **OPEN**



When you reattach a gas spring, make sure the quick-release tab is in the closed position.

WARNING

Do not attempt to install or remove your gas springs without supporting the access panel with your other hand.

OPERATING INSTRUCTIONS

FOLDING THE ACCESS PANELS

The access panels on your DiamondBack can open 180° and rest against the closed portion of the cover so you can haul items taller than your bed rails without having to remove the entire cover.

1. Remove the gas springs from the access-panel ball studs.

WARNING

Do not attempt to install or remove your gas springs without supporting the access panel with your other hand.

2. Fold the access panel completely back until it rests on the closed portion of the DiamondBack.

3. Secure the folded access panel with a ratchet strap that runs side to side and is either hooked onto the tie-down cleats or to hooked to itself under the cover.

WARNING

Never drive your truck without securing folded access panels with ratchet straps.

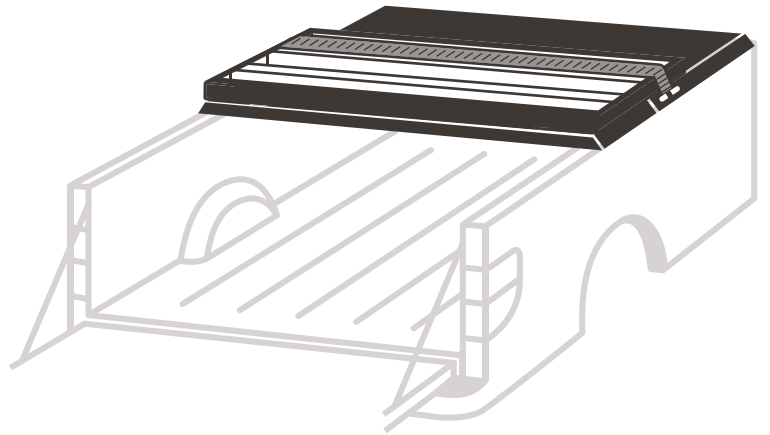

★ If your DiamondBack includes side adapter bars, its access panels can't be folded over. Instead, you'll have to remove the panel as described below and then lay it down to strap it.

REMOVING THE ACCESS PANELS

The access panels on your DiamondBack can be detached from the center panel individually so you can haul items taller than your bed rails without having to remove the entire cover.

1. Remove the gas springs from the access-panel ball studs, remembering to support the panel with one hand as you do.

2. Tilt the access panel to exactly 90 degrees.

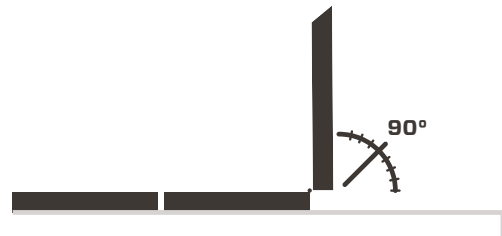

3. Grip the panel by the middle stud with both hands. Separate the panel from the right, drop-on hinge by lifting with your right hand only. Keep the pivot and tilt of the panel to an absolute minimum as you separate the left, slip-joint hinge by sliding the whole panel to the right.

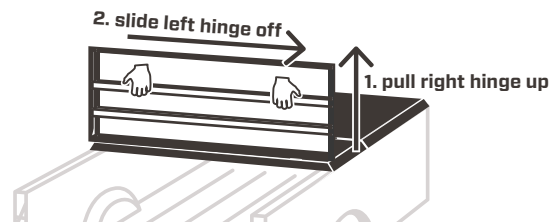

OPERATING INSTRUCTIONS

LOAD SECUREMENT

DANGER

Failure to properly secure cargo or hauling inappropriate cargo may result in property damage, serious bodily injury, or death.

1. Attach one end of a ratchet strap to a tie-down cleat and run the strap across the load to the opposite side of the cover.

2. Attach the other end of the ratchet strap to another tie-down cleat. Tighten the strap.

3. Repeat using multiple straps with opposing forces to prohibit cargo from shifting in any direction.

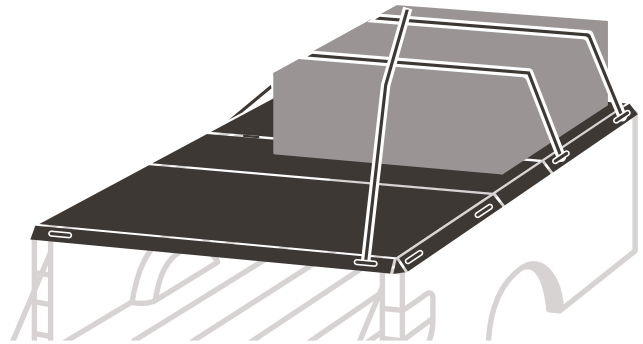

WARNING

- Do not exceed the distributed load rating of 1600 lbs or two full-size ATVs on top of your DiamondBack HD. Do not exceed the distributed load rating of 400 lbs on top of your DiamondBack SE, DiamondBack 270, or DiamondBack 180.
- The hauling capacity of your DiamondBack applies to your DiamondBack only. Do not exceed your vehicle manufacturer's specified load capacity for rail-mounted accessories.
- Hauling on top of your DiamondBack will raise your truck's center of gravity. Avoid excessive speeds, fast braking, and sudden, sharp turns.
- Do not haul lumber, pipe, or other slender objects on top of your DiamondBack without using a cab guard.
- Do not use bungee cords to secure cargo on top of your DiamondBack.
- Follow the hauling regulations in your state or province. It is the user's responsibility to conform with all laws and DOT regulations in their state or province.

OPERATING INSTRUCTIONS

ATV SECUREMENT

DANGER

Failure to properly secure ATVs or side-by-sides before hauling may result in property damage, serious bodily injury, or death.

1. Hook a ratchet strap to the underside of an A-arm.

2. Run the strap diagonally under the ATV toward the opposite tire.

3. Hook the other end of the strap to the tie-down cleat nearest to the opposite tire.

4. Repeat steps 1-3 at the other three corners of the ATV.

5. Tighten all four straps.

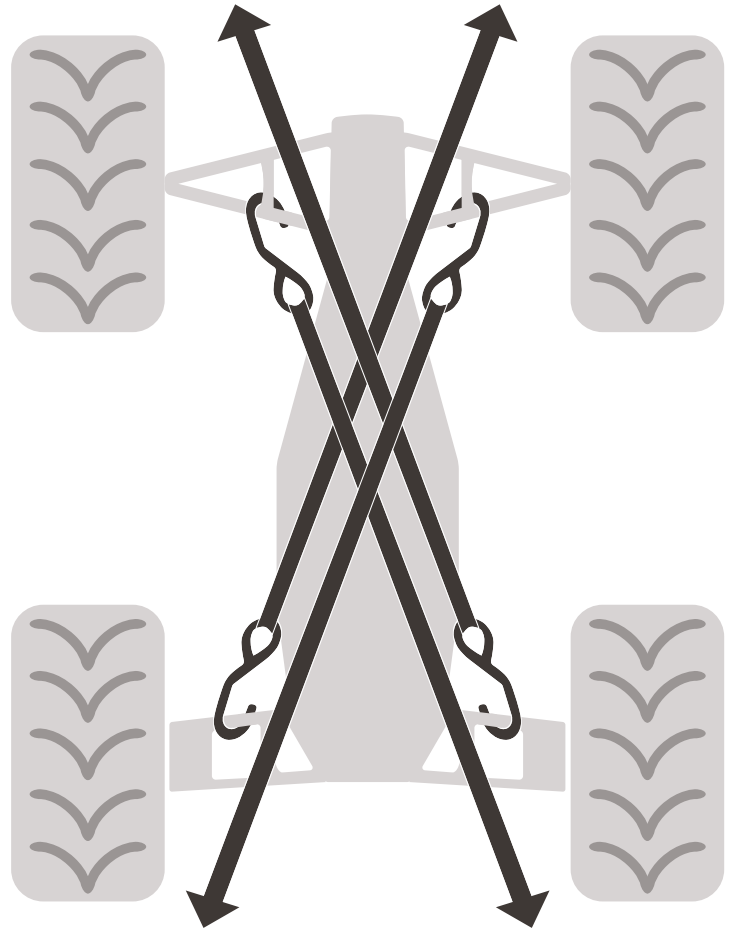

WARNING

- Do not attach a strap to a handlebar, bumper, or rack.
- Do not run a strap over an edge that may cut, fray, or wear through the webbing.
- Do not install your straps perpendicular to the cover. Perpendicular straps will bend your panels, hinges, and/or bed rails.
- Do not use a strap to compress the suspension of the ATV.

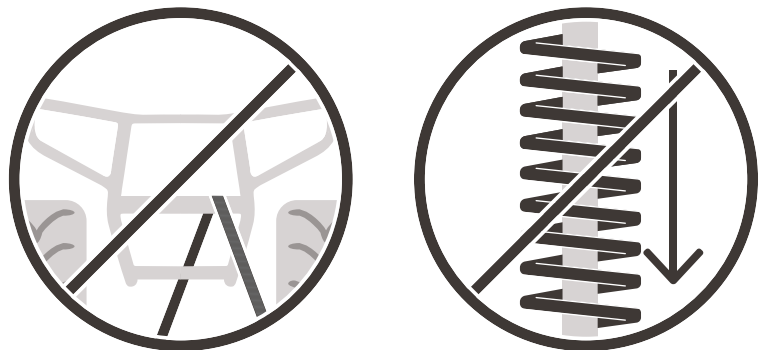

TROUBLESHOOTING

PROBLEM	CHECK	CURE
FIT & ALIGNMENT		
<p>I can't get the lock rods to engage or disengage to close or open my access panels.</p>	<p>Have you broken in the weatherstrip?</p> <p>Are you applying downward pressure when opening and closing?</p> <p>Does it feel like it's the lock rods themselves that are getting stuck?</p>	<p>No? Make sure the weatherstrip is compressed and keep the access panels closed for 3 days or more to break it in.</p> <p>No? Opening and closing the access panels is easiest when you press down on them.</p> <p>Yes? Apply some petroleum jelly to the top of the lock rod end caps where they make contact with the truck.</p>
<p>My access panels remain elevated after installation.</p>	<p>Did you compress/crush the weatherstrip during installation?</p>	<p>No? Have a second person press down on the DiamondBack while you readjust the lock rods so they draw the panels down and compress the weatherstrip.</p>
<p>With a cab guard or Headache Rack bolted on, my cab panel is hard to open.</p>	<p>Are the gas springs under your cab panel stronger than those under the tail panel?</p>	<p>No? If the cab-panel gas springs are weaker than the tail-panel ones, switch them. If they're the same strength, call us at (800) 935-4002 x2.</p>
ATV HAULING		
<p>The tailgate of my truck won't open or close when I have ATVs on top of my DiamondBack.</p>	<p>Are you pushing up on your ATV when you try to operate the tailgate?</p>	<p>No? Try pushing up on your ATV or extension deck.</p> <p>Yes? Call DiamondBack to order a shim kit. It will help take the pressure off the top of the tailgate.</p>
<p>I can't get my ramps out from under the back tires of my ATV.</p>	<p>Have you tried sliding the ramps sideways?</p> <p>Do you know the maximum ATV size that your DiamondBack will accept?</p>	<p>No? Try lifting the ramps hooks slightly and sliding the ramps sideways.</p> <p>No? Check the ATV Fit Guide on our website (http://dback.co/atv-fit). If your ATV is indeed too long, it's possible that risers will provide the additional room you need. The Rear Extension may also help. Call DiamondBack for details.</p>

TROUBLESHOOTING

PROBLEM	CHECK	CURE
WEATHER PROTECTION		
My cover leaks at the bulkhead.	<p>Have you installed the bulkhead weatherstrip?</p> <p>Is your perimeter weatherstrip compressed?</p>	<p>No? If your truck has bed rail caps, you should affix the bulkhead weatherstrip that came with your DiamondBack.</p> <p>No? Have a second person press down on the DiamondBack while you readjust the lock rods so that they draw the panels down and compress the weatherstrip.</p>
My cover leaks along the sides.	Is your perimeter weatherstrip compressed?	No? Have a second person press down on the DiamondBack while you readjust the lock rods so that they draw the panels down and compress the weatherstrip.
My cover leaks at the tailgate.	Is your weatherstrip compressed against the top of the tailgate?	No? Have a second person press down on the tailgate panel while you readjust your lock rods so they draw the panels down and compress the weatherstrip.
My cover leaks, but I can't tell where.	Have you looked from inside the cargo bed?	No? Climb in the bed, close the cover, and survey the entire perimeter of the bed for light gaps. Water probably gets in where you see light. If light comes in near the corners of the cover and none of the other cures listed on this page apply, you may need to seal the gap with store-bought weatherstrip or silicone.
My weatherstrip freezes to the bed rails.	—	Treat your weatherstrip with a petroleum jelly or silicone-based lubricant.

If the problem you're having isn't listed above or can't be corrected using these methods, please contact a DiamondBack customer support representative at (800) 935-4002 x2 or support@diamondbackcovers.com.

MAINTENANCE

INSPECTING YOUR DIAMONDBACK

Every time you haul cargo on top of your DiamondBack you should first inspect the following parts that may be loose, bent, or damaged:

- 1. Lock Rods
- 2. Set Screws
- 3. Rod Guide Brackets
- 4. Cap Clamps
- 5. Hinges
- 6. Tie-Down Cleats and Hardware

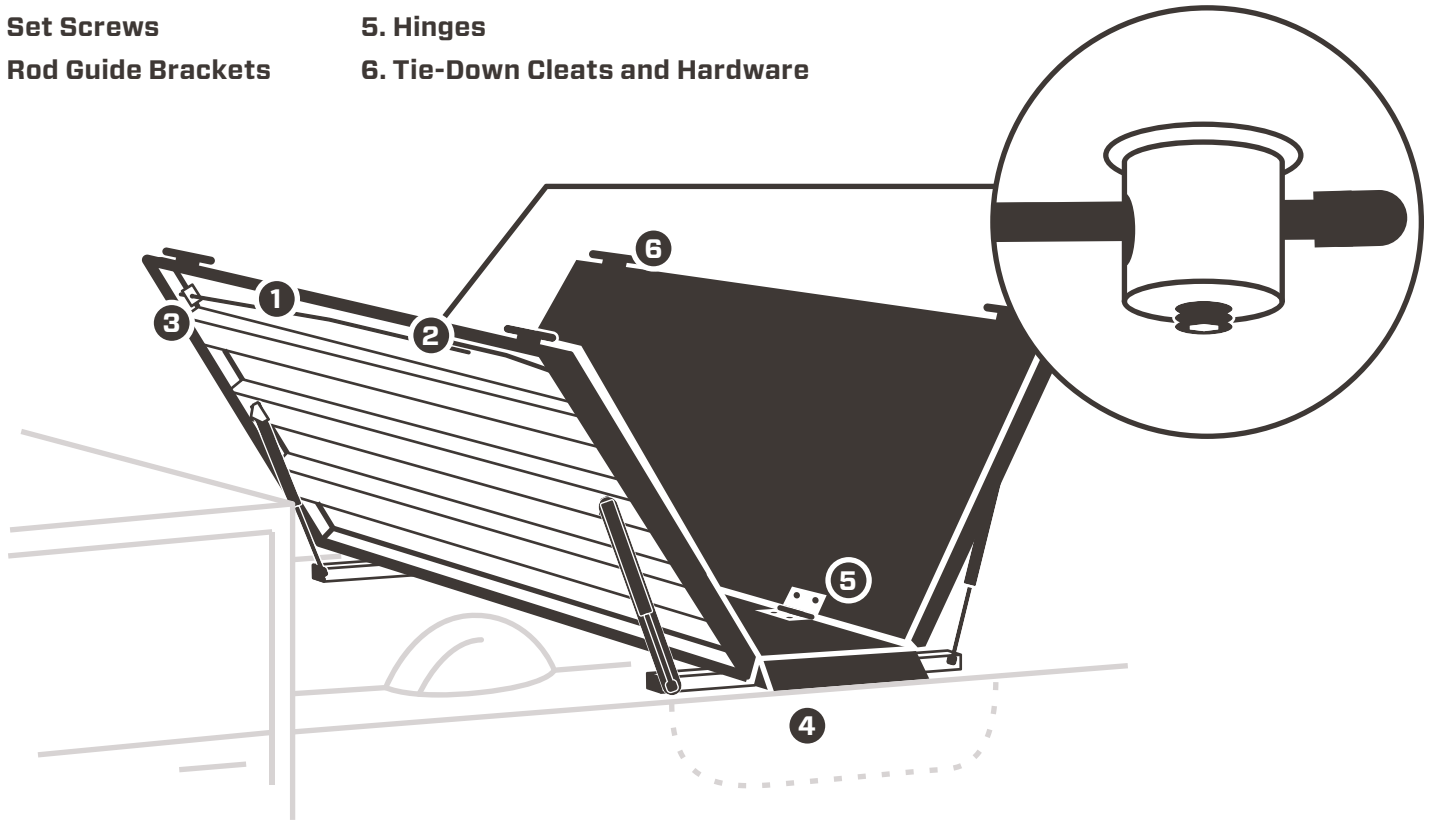

! Check and, if needed, tighten your cap clamps, lock rod guide brackets, and lock rod set screws every time you haul on top of your DiamondBack.

MAINTAINING YOUR DIAMONDBACK

If the lock cylinders on your DiamondBack begin to stick, lubricate them by spraying them with a dry graphite or dry silicone lubricant.

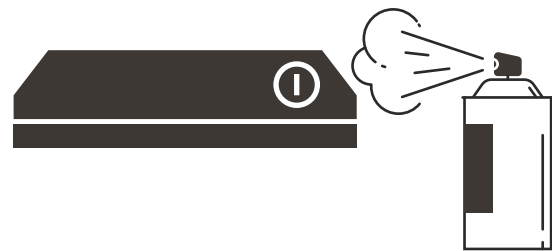

Readjust the lock rods and rod guide brackets on your DiamondBack at about 100 miles after initial installation because they will loosen as the weatherstrip and hinges wear in.

MAINTENANCE

CLEANING YOUR DIAMONDBACK

Wash your DiamondBack as often as you wash your truck. If you have a polished aluminum DiamondBack, wax it to prolong the shine.

 Never apply paste wax to the Rugged Black coating.

If the polished aluminum on your DiamondBack appears dull, use aluminum polish to restore its shine. Polish works best when it is applied sparingly and removed completely.

DISASSEMBLING A LOCK

1. Use a 1/2" socket to remove the lock nut and cam from the base of the lock.

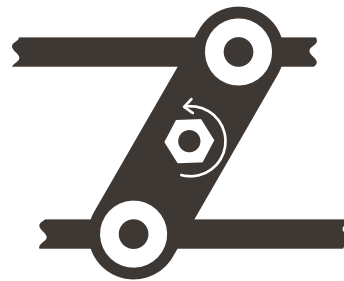

2. Turn the lock handle 90° to expose the Phillips machine screws that attach the lock base to the cover. Hold the 3/8" nuts on the underside of the cover and remove the screws with a Phillips screwdriver.

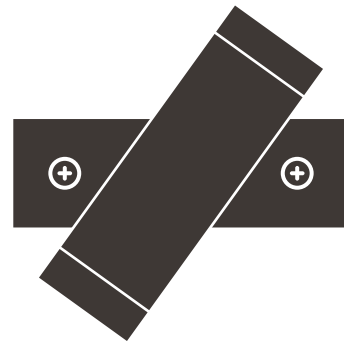

3. Use an adjustable wrench to remove the large ring nut from the stem of the lock. Pull the lock handle out of the cover.

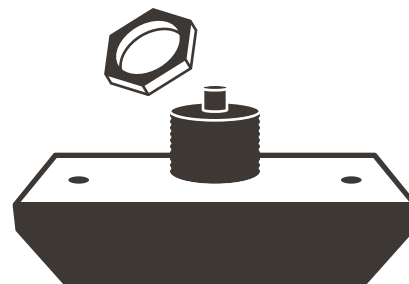

4. Reverse for installation.

MAINTENANCE

REPLACING WEATHERSTRIP

 **20 minutes**
Normal install time

PARTS INCLUDED:



Weatherstrip

24' for covers shorter than 7'
26' for covers 7' or longer

TOOLS REQUIRED:



Rubbing Alcohol
or Glass Cleaner



Clean, Lint-
Free Cloth



Utility Knife

 To ensure the weatherstrip sticks, make sure the surface temperature of your cover is at least 50°F and will remain so for at least a day.

1. With the cover closed, mark the cab panel weatherstrip flange on the driver side where the center panel gutter under it begins. Repeat on the passenger side. These marks will serve as the start and end points for the weatherstrip.

 To ensure the best possible seal, keep in mind when making these marks that the weatherstrip ought to touch and compress slightly against the gutter edge. If anything, cheat the marks slightly toward the gutter.



2. Open the cab panel. Remove the original weatherstrip from the flange.

3. Clean the return flange thoroughly with a clean, lint-free cloth and rubbing alcohol or glass cleaner. Allow to dry.

4. Align one end of the weatherstrip with the mark on the driver side of the flange. Peel off the backing as you affix the weatherstrip along the exterior edge of all three sides of the flange. Press down firmly with your thumb as you proceed. Stop once you reach the mark on the passenger side of the flange.

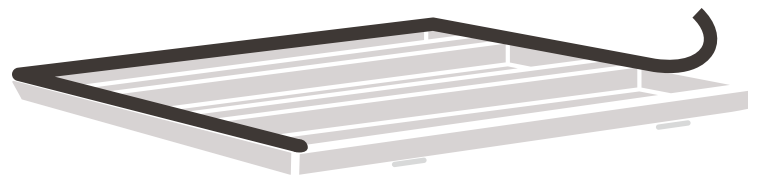



5. Cut off the excess weatherstrip. Close and lock the cab panel. Leave it closed for 24 hours to allow the weatherstrip adhesive to cure.

 Cut carefully: To seal as well as possible, the weatherstrip should touch and compress slightly against the gutter edge. If the weatherstrip comes up short of that, there'll be a gap for water to get in. If the weatherstrip is too long, it will wrinkle against the gutter and its adhesive will fail.

6. Repeat steps 1-5 on the tailgate panel.

 Roughly speaking, the turns the weatherstrip has to make around the corners of the panel should have about a 2" radius to them to avoid pinching or stretching it. So as you apply, start making the turn before you get to the corner itself.

 Take your time with this step, especially at the corners. DiamondBack weatherstrip features a single-use adhesive.

 Never stretch the weatherstrip when applying. If you do, its adhesive will fail.



DIAMONDBACK

800 935 4002 / DiamondBackCovers.com

354 Enterprise Drive, Philipsburg, PA 16866