



TacticalFlowMeter.com by Take 5, Inc.
 22642 Indian Springs Road
 Salinas, California 93908
 831-455-0418
 Dave@TacticalFlowMeter.com

MAG Flow Meter Product Line Overview

Note: The standard offering is the SS304 Flange Type with 150# ANSI Flanges and PTFE liner.

MAG Flow Meter								
Categories	Small size remote type	Small size integrated type	Large size remote type	SS304 Flange type	SS304 Sanitary type	SS304 Insertion type	Battery powered	Battery powered with GPRS
Pressure	230 PSIG, 1.6 Mpa typical, others available				230 PSIG, 1.6 Mpa	230 PSIG, 1.6 Mpa	230 PSIG, 1.6 Mpa	
Size	1/8" to 10 feet in diameter				1/2" to 4" Sanitary	8" and above	1/2" to 12" Flange sizes	
Flange	ANSI B16.6 150# Standard, others available							
Power	24 VDC or 120 VAC						Battery	
Outputs	4-20 mA / pulse (frequency)							
Communication	RS-485							
Lining	PTFE standard with the following options Rubber, PFA, F46, or Polyurethane					Nylon (Probe)	PTFE, or Rubber, PFA, F46, or Polyurethane	
Fluid	For conductive liquids with conductivity greater than 5 µs/cm For reference note tap water has conductivity between 5 - 50 µs/cm							
Electrode	316L with the following optional electrode materials available: Hastelloy B or C, Titanium, Tantalum and Platinum-Iridium							
Protection	IP65 / IP67 / IP68							
Temperature	Ambient: -25 to 65 Deg C / Medium: PTFE lining 70 Deg C max							
Ex-proof	Yes							

Standard SS304 Flange type stocked MAG meters

Alarm indicator

Flow volume: +282.92

Unit: FQH × 1 m³/h

Flow velocity (FLS): Σ +00000013.5 m³

Percentage (FQP)

Ratio of emptiness (MTP)

Forward and reverse intergrated volumes

Difference of forward and reverse

Alarm

Enter

Up ; plus1, page up

Down ; minus1, page down

Compound

MAG FLOW METER, 1/2", 1", 2", 3", 4", 6", 8" & 12" ANSI PIPE FLANGE SIZE RANGES MAG MASS FLOW METERS FEATURE ACCURACIES OF 0.5% OF READING. AMAZING SENSITIVITY FOR CONDUCTIVITY ONLY REQUIRING A MINIMUM OF 5 MICROSIEMENS/CM (COMPARED TO MORE THAN 20 MICROSIEMENS/CM REQUIRED FOR CONVENTIONAL MAG METERS)

Flow Inlet/Outlet Installation guidelines.

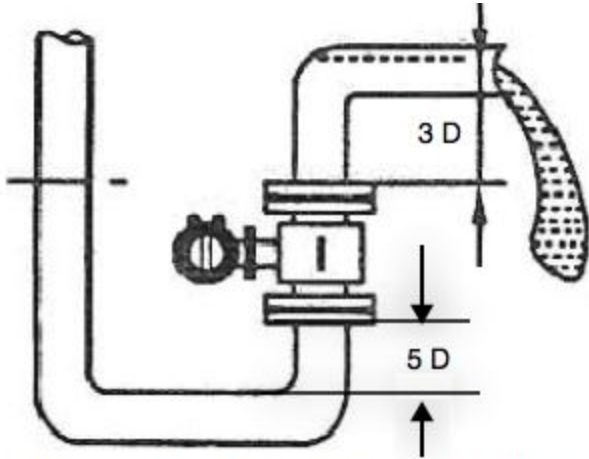

Install so that the meter is located so the outlet is at least 3 Pipe Diameters from any obstruction or elbow and the inlet is at least 5 Pipe Diameters and the meter is always submerged and there are no air bubbles

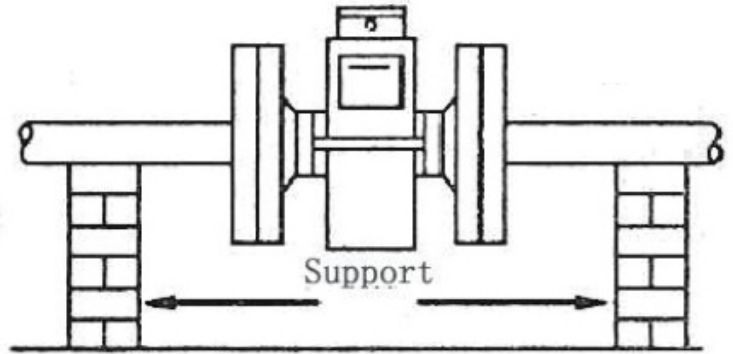

Install so that the meter is supported and not causing stress on the flanges.

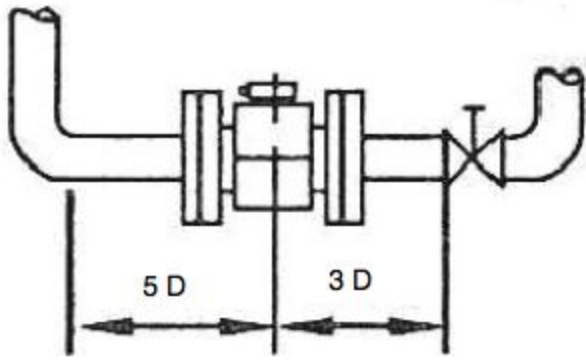

Install so that the meter is located so that the outlet is at least 3 Pipe Diameters from any obstruction or elbow and the inlet is at least 5 Pipe Diameters and the meter is always submerged and there are no air bubbles

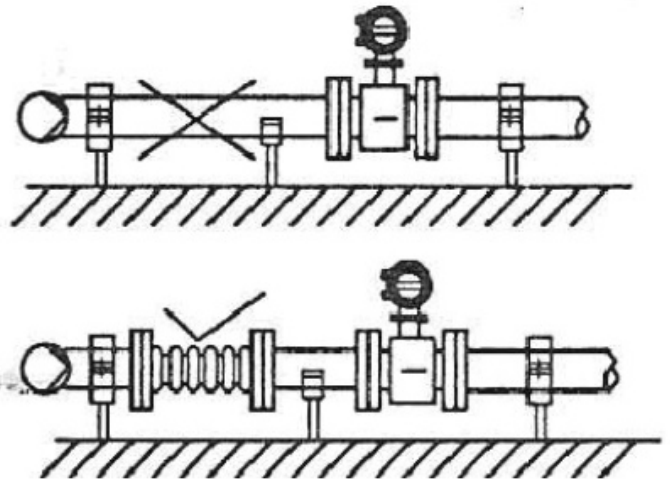

Isolate meter from vibration as shown

VERY IMPORTANT

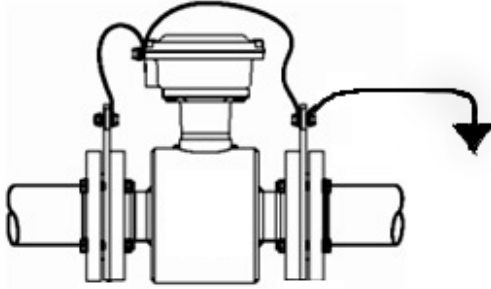

Install the MAG meter and connect the inlet and outlet to a proper GROUND line. This is the Solution Ground, called SG, and is very important for a stable ZERO FLOW measurement.

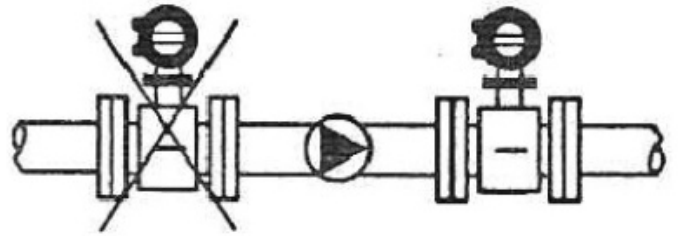

Do not install a MAG meter at the INLET of a pump as this will introduce bubbles. Instead, put it on the OUTLET with at least 5 diameters upstream.

MAIN INSTALLATION REQUIREMENTS: Never let a MAG meter run with no liquid or do not run the meter downstream of a pump that can inject bubbles, or downstream of a valve that can create bubbles in the flow. The BEST installation is shown in the upper left graphic. Grounding is very important for stable Zero Flow measurements.

METER DIMENSIONS

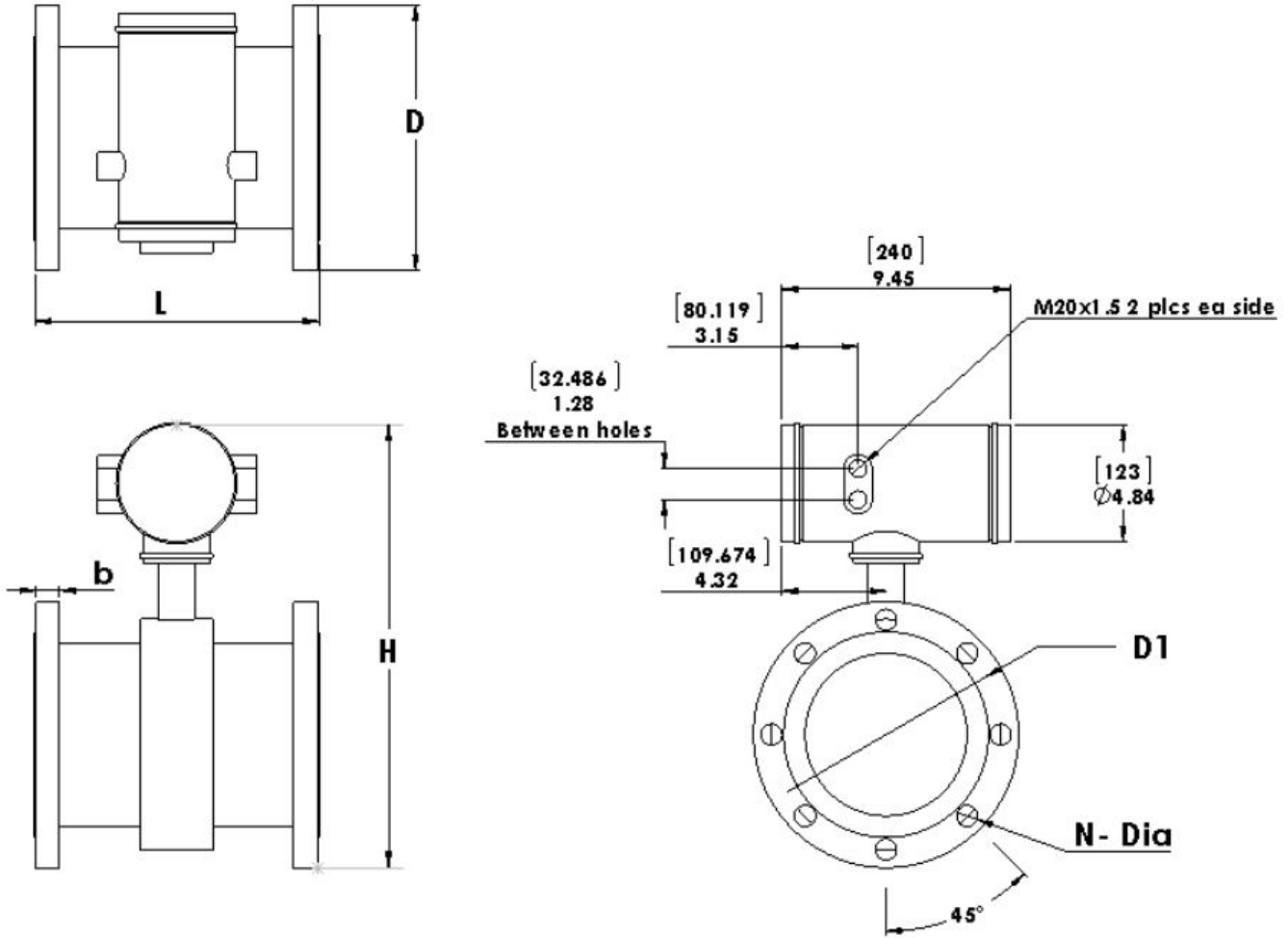

ANSI Size	DN Size	GPM @ 10 m/s	L		b		N-Dia		N (# Bolts)	H		D	
			L (Pipe length)		C (flange thick)		Flange Bolt Dia			Meter height		Flange OD	
			inches	mm	inches	mm	inches	mm	inches	mm	inches	mm	inches
½"	15	30	7.874	200	0.551	14	2.375	60.325	4@ 0.625"	10.433	265	3.740	95
¾"	20	50	7.874	200	0.630	16	2.750	69.85	4@ 0.625"	10.827	275	4.134	105
1"	25	80	7.874	200	0.630	16	3.125	79.375	4@ 0.625"	11.220	285	4.528	115
1 ¼"	32	130	7.874	200	0.709	18	3.500	88.9	4@ 0.625"	12.283	312	5.512	140
1 ½"	40	200	7.874	200	0.709	18	3.875	98.425	4@ 0.625"	12.598	320	5.906	150
2"	50	315	7.874	200	0.787	20	4.750	120.65	4@ 0.75"	13.189	335	6.496	165
2 ½"	65	530	7.874	200	0.787	20	5.500	139.7	4@ 0.75"	13.976	355	7.283	185
3"	80	800	7.874	200	0.787	20	6.000	152.4	4@ 0.75"	14.567	370	7.874	200
4"	100	1300	9.843	250	0.866	22	7.500	190.5	4@ 0.75"	15.354	390	8.661	220
5"	125	1950	9.843	250	0.866	22	8.500	215.9	6@ 0.875"	16.535	420	9.843	250
6"	150	2800	11.811	300	0.945	24	9.500	241.3	8@ 0.875"	17.717	450	11.220	285
8"	200	5000	13.386	340	1.142	29	11.750	298.45	8@ 0.875"	21.654	550	13.583	345
10"	200	5000	17.323	440	1.181	30	14.250	361.95	12@ 1.02"	23.622	600	15.945	405
12"	200	5000	19.291	490	1.260	32	17.000	431.8	12@ 1.02"	26.772	680	17.008	432

Insertion MAG meters:

Insertion MAG Meter Dimensions

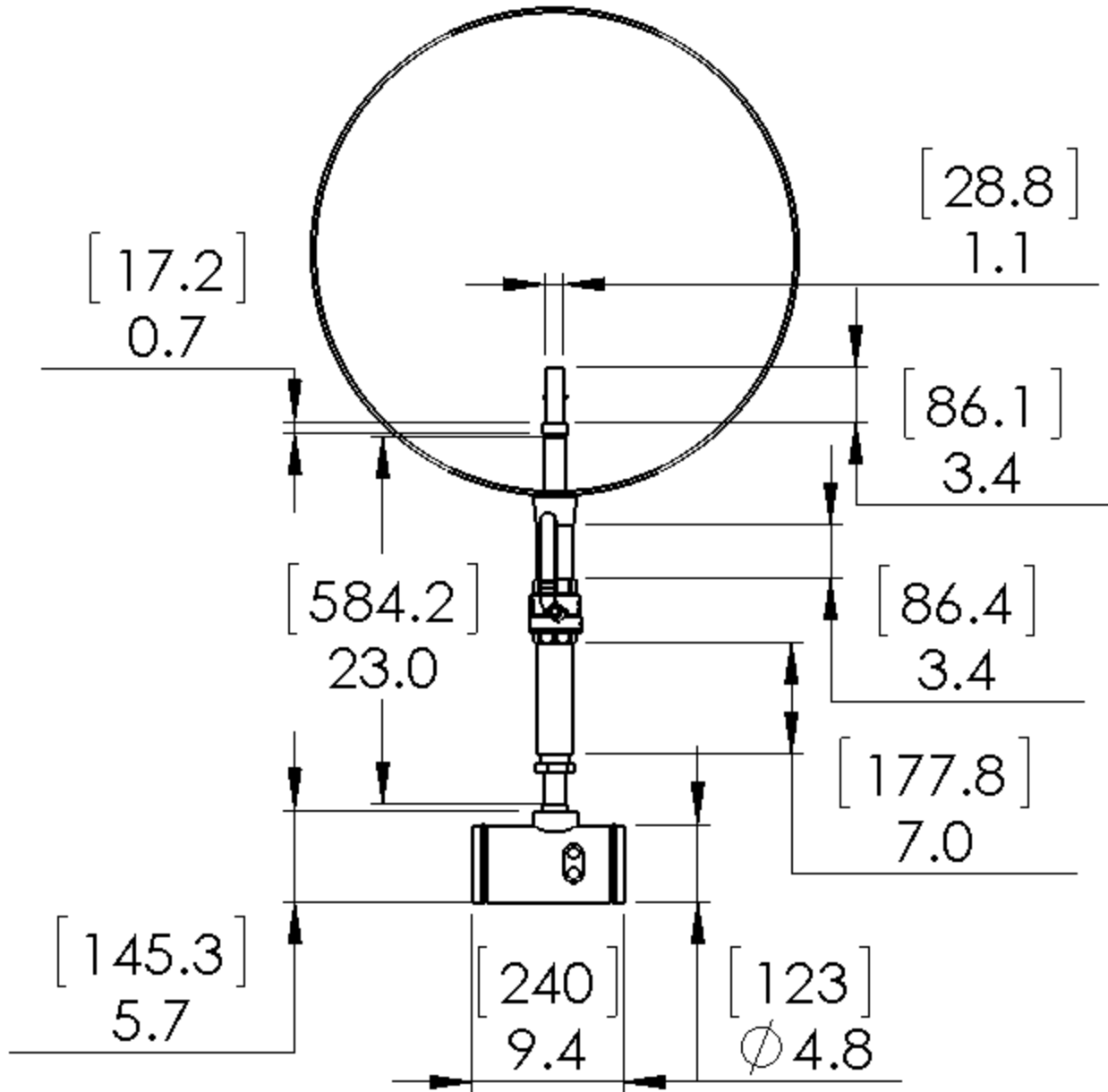

Please visit [INSERTION MAG meter product listing](#).



Insertion MAG Meter Specifications. For pipe diameters 8" or above.

- Insertion 6" to 42" Diameter pipe
- Wetted Materials Teflon & 316 SS
 - Flow Body Material 304 SS
- Flows from 100 kg/h to 200,000 kg/h relative to water
 - Accuracy: +/- 0.5% of reading in water.
 - Repeatability of +/- 0.05% of reading
- 1/2" to 4" 150# ANSI Flange Connections, up to 6" available custom.
 - LCD Display
 - Temperature:
 - Gas: -58°F (-50°C) to 350°F (180°C)
 - Ambient: 14°F (-10°C) to 140°F (60°C)
- Power Requirement: Order either 24 VDC or 85-220 VAC, 15 Watts maximum;
- Output signals: Modbus RTU, 4–20 mA, and 0-10 KHz for flow rate indication
 - Digital communications: Modbus RTU
 - Proof Pressure 230 PSIG, 1.6 MPa.
- Display: Flow rate, Flow Rate 0-100%, and Total flow
 - Wiring connection to enclosure size: M20 x 1.5
 - Factory Final QC Test Certificate
 - Integral Electronics installation
 - Electronics Enclosure NEMA 4X / IP67
 - Conductivity > 5 microSiemens/cm

Insertion Installation Drawing:

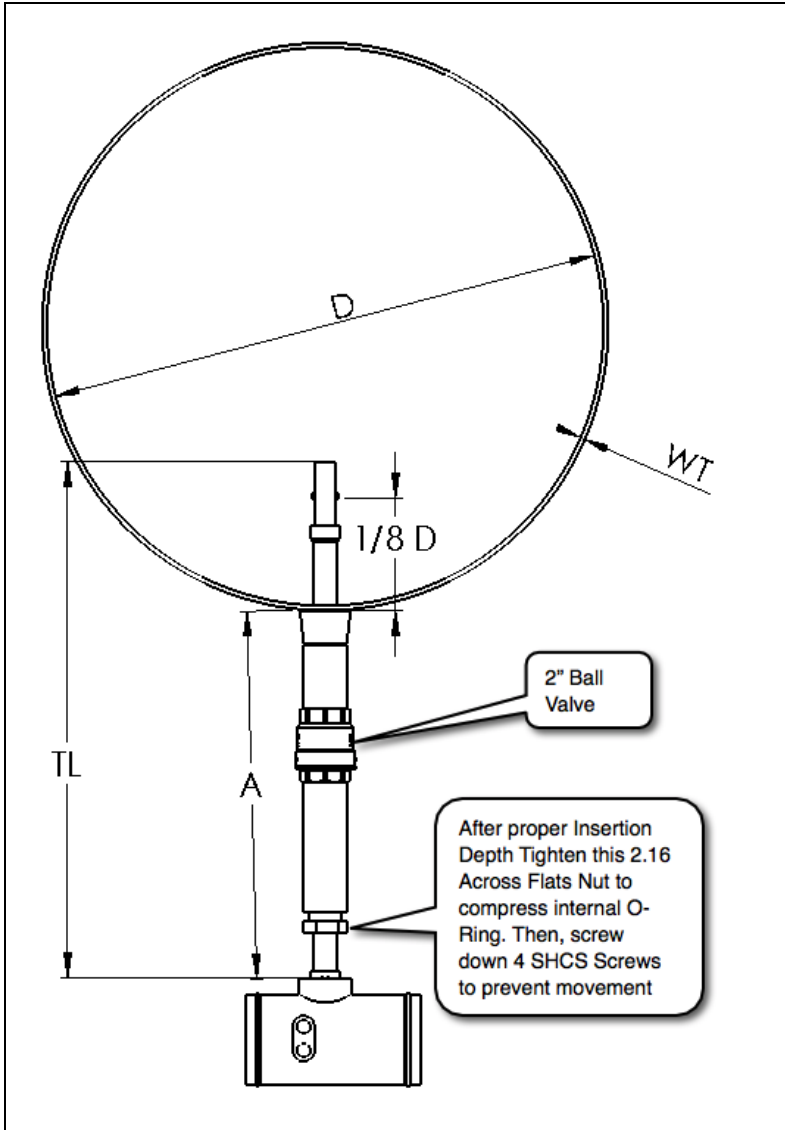

For clean water, the sensor may be placed at 1/8 of the inside diameter of the pipe.

Measure the tube from the top of the cap to the end of the sensor to find tube length

Calculate (1/8 D): $1/8 D = 0.125 \times \text{Pipe ID}$

Add wall thickness(WT) to 1/8 D

Calculate distance A: $A = TL - (1/8 D + WT)$

Position the top edge of the tube so that its distance from the OD of the pipe is equal to "distance A" Then Tighten as shown to the left.

