

AC INFINITY

IONFRAME SERIES GROW LIGHT SYSTEM

USER MANUAL

SAMSUNG
HORTICULTURE LED



Illuminated

Plant-centric
Spectrum

EVO

WELCOME

Thank you for choosing AC Infinity. We are committed to product quality and friendly customer service. If you have any questions or suggestions, please don't hesitate to [contact](#) us. Visit www.acinfinity.com and click contact for our contact information.

EMAIL

support@acinfinity.com

WEB

www.acinfinity.com

LOCATION

Los Angeles, CA

MANUAL CODE IF2306X3

PRODUCT

IONFRAME EVO3
IONFRAME EVO4
IONFRAME EVO6
IONFRAME EVO8
IONFRAME EVO10

MODEL

AC-IF3K
AC-IF4K
AC-IF6K
AC-IF8K
AC-IF10K

UPC-A

819137024045
819137024052
819137024069
819137024076
819137024083

MANUAL INDEX

Manual Index	Page 5
Product Warning	Page 6
Key Features	Page 7
Product Contents	Page 8
Installation	Page 10
Powering and Setup	Page 17
Controller Mounting	Page 20
Starter Guide	Page 22
UIST™ Platform	Page 24
UIST™ Compatibility	Page 25
Adding More Lights	Page 26
Programming	Page 29
Other Settings	Page 34
Other AC Infinity Products	Page 35
Warranty	Page 36

PRODUCT WARNING



TO REDUCE THE RISK OF FIRE, ELECTRIC SHOCK, OR INJURY TO PERSONS,
OBSERVE THE FOLLOWING:

1. Ensure your power source conforms to the electrical requirements of this product.
2. Check your local code restrictions for additional safety measures that may be needed for a proper code compliant installation.
3. Read all instructions before installing and using this product.
4. If you are unfamiliar or have doubts about performing this product's installation, seek the services of a qualified, trained, and licensed professional. Inappropriate installation will void this product's warranty.
5. Do not attempt to hardwire this product. Performing any retrofitting actions may result in personal injury and/or electrical damage, and will void this product's warranty.
6. This product must not be used in potentially hazardous locations such as flammable, explosive, chemical-laden or wet atmospheres.
7. Do not cover power cords with rugs or other fabric materials.
8. Safety precautions should be exercised during the installation, operation, and maintenance of this product.
9. Do not block or tamper with this product in any manner while it is in operation as it may cause electric shock, fire, or damage to this product.
10. Do not depend on the on/off programming as the sole means of shutting power from this product. Unplug the power cord before installing, servicing, or moving this product.
11. Do not operate this product while its cord is damaged, or if it malfunctions, has been dropped, or is damaged in any manner.

KEY FEATURES

SAMSUNG LED DIODES

Commercial-grade Samsung LM301H EVO LEDs deliver full-spectrum lighting to achieve greater growth rates.

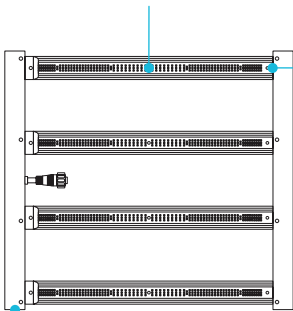

IP65 PROTECTION

Sealed to Ingress Protection 65 standards against liquids and dust for excellent performance in grow tent environments.

EVEN COVERAGE

Algorithmically spaced diodes achieve wider light spread for optimized use in all grow stages while eliminating hot spots.

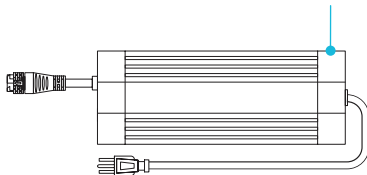

REMOVABLE DRIVER

Detachable LED driver allows for flexible placement along grow tent walls or positioning outside of the tent.



CUSTOM LED DRIVER

Designed to reliably deliver high-wattage power and enables PWM control of its power output.



SCHEDULE CONTROLLER

Digital controller features SCHEDULE and SUNSET/RISE modes that trigger activation in ten light intensity levels.

IONFRAME EVO4 (AC-IF4K) shown



Plant-centric
Spectrum

EVO

PRODUCT CONTENTS

ALL MODELS



GROW
LIGHT*
(x1)



SCHEDULE
CONTROLLER
(x1)



DRIVER
BRACKETS
(x2)



ROPE
CLIPS
(x2)



STAINLESS STEEL
WIRE HANGERS
(x2)



UIS M-M
CORD, 2 FT.
(x1)



UIS M-M
CORD, 10 FT.
(x1)



WIRE
TIE SET
(x1)



HOOK AND
LOOP TIES
(x4)



NYLON
SCREWS
(x6)



CONTROLLER
PLATE BOLTS
(x2)



HEX
NUTS
(x3)



WOOD SCREWS
(CONTROLLER)
(x2)

IONFRAME EVO3, IONFRAME EVO4, IONFRAME EVO6, IONFRAME EVO8

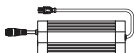

LED
DRIVER
(x1)



DRIVER
CORD
(x1)



WOOD SCREWS
(DRIVER)
(x4)



DRIVER SCREWS
(BRACKET MOUNT)
(x4)

*IONFRAME EVO4 (AC-IF4K) shown

PRODUCT CONTENTS

IONFRAME EVO10

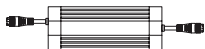

LED
DRIVER
(x2)



DAISY-CHAIN
ADAPTER
(x1)



DUAL DRIVER
POWER CORD
(x1)



DRIVER
CORD
(x2)



UIS M-M
CORD, 1 FT.
(x1)



WOOD SCREWS
(DRIVER)
(x8)



DRIVER SCREWS
(BRACKET MOUNT)
(x8)

INSTALLATION

DRIVER MOUNTING (FRAME)

STEP 1

Align the brackets' mounting holes with the driver's mounting points located on the driver's underside, making sure the brackets' legs are pointing up.

Secure the brackets by screwing in the driver screws using a Phillips screwdriver.

Repeat this process with the second driver if you have the IONFRAME EVO10.

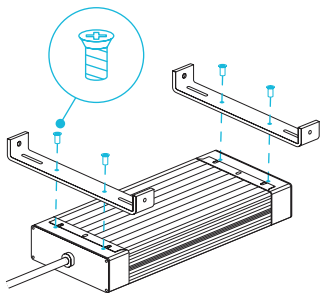

STEP 2

Flip the driver over and place it over the two* center columns of your grow light.

Secure the brackets to the columns by screwing in the nylon screws using a flathead screwdriver.

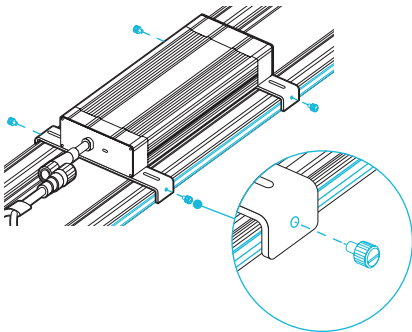

*Four center columns for the IONFRAME EVO10

INSTALLATION

DRIVER MOUNTING (FRAME)

STEP 3

Connect the driver socket to the grow light connector. This will lock the connection in place.

Twist the lock and pull the connector out to disconnect it from the driver's socket.

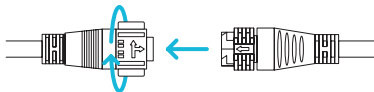

Repeat this process with the second driver if you have the IONFRAME EVO10.

INSTALLATION

DRIVER MOUNTING (WALL)

STEP 1

Align the brackets' mounting holes with the driver's mounting points located on the driver's underside, making sure the brackets' legs are pointing down.

Secure the brackets by screwing in the driver screws using a Phillips screwdriver.

Repeat this process with the second driver if you have the IONFRAME EVO10.

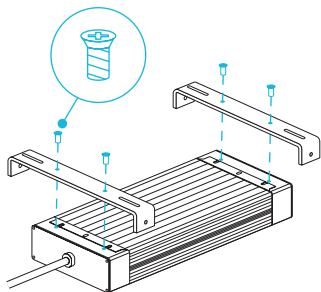

STEP 2

Mark your desired mounting position using the brackets' mounting slots.

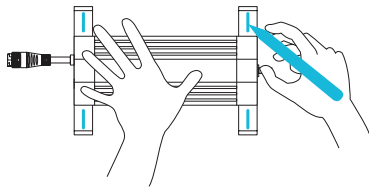

INSTALLATION

DRIVER MOUNTING (WALL)

STEP 3

Drill four holes into the marked locations. Make sure your mounting area is structurally sound and free from obstruction.

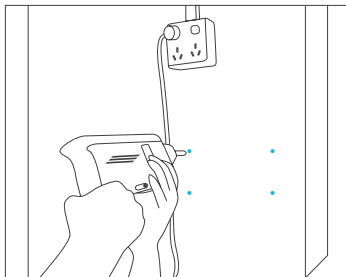

STEP 4

If you are mounting onto anything other than a wood support or stud, insert the included four wall anchors into the drilled mounting holes.

You may need to use a hammer to secure them through the holes.

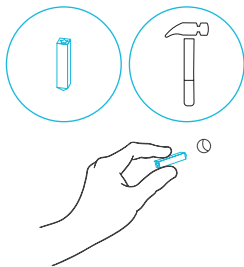

INSTALLATION

DRIVER MOUNTING (WALL)

STEP 5

Align the bracket's holes with the wall anchors. Screw in four wood screws with a screwdriver or drill to secure the brackets.

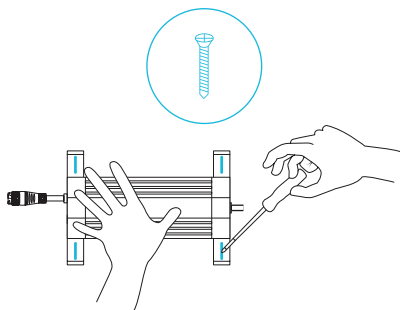

STEP 6

Connect the driver socket to the grow light connector using the driver extension cord.

Twist the lock and pull the connector to disconnect it from the driver's socket.

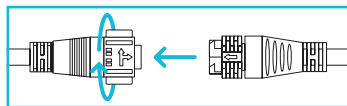

Repeat this process with the second driver if you have the IONFRAME EVO10.

INSTALLATION

HANGING

STEP 1

Clip the lanyard hooks onto the four anchors located at the corners of your grow light.

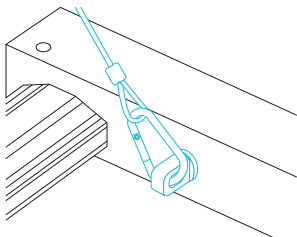

STEP 2

Clip the two carabiners onto your grow tent's roof support beams.

You may also use rope clip hangers to hang your grow light lower.

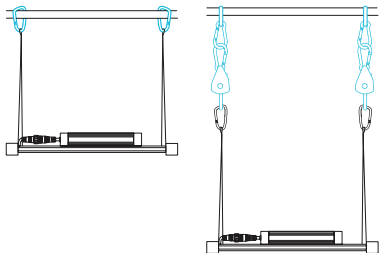

INSTALLATION

SUPPLEMENTAL LIGHTING



IONBEAM LED light bars (not included) can magnetically mount to the frame to adjust the light spectrum, introduce new spectrums (UV/IR), and increase the light intensity output.

STEP 1

Magnetically mount the LED light bars onto the frame of your grow light.

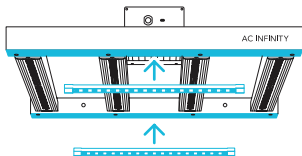

STEP 2

You may connect the LED light bars' controller to the schedule controller using a UIS extension cord to match its schedule with your grow light's schedule.

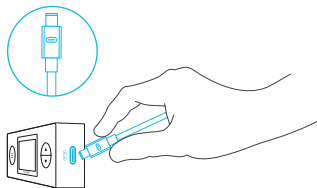

POWERING AND SETUP

SINGLE DRIVER

STEP 1

Plug the power cord into an AC power outlet to power your grow light.

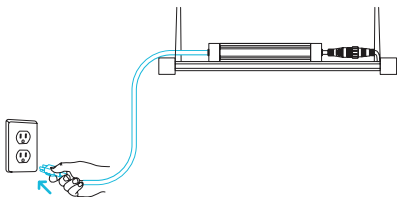

STEP 2

Plug one end of the UIS extension cord into the LED driver, and the other end into the schedule controller.

You may alternatively use another UIS controller to set smart programming.

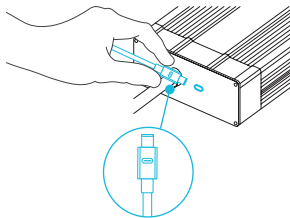

POWERING AND SETUP

DUAL DRIVER

STEP 1

Connect the driver sockets to the dual driver power cord connectors.

Plug the power cord into an AC power outlet to power your grow light.

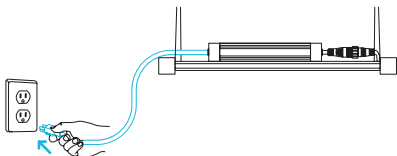
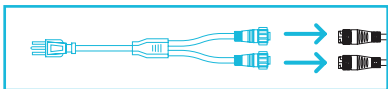

STEP 2

Plug the male end of the daisy-chain adapter into one of the LED drivers.

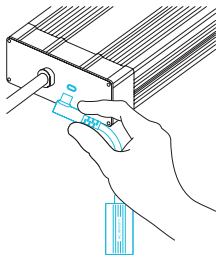

POWERING AND SETUP

DUAL DRIVER

STEP 3

Plug one end of the 1 ft. M-M UIS cord into the second LED driver, and the other end into the daisy-chain adapter's OUTPUT port.

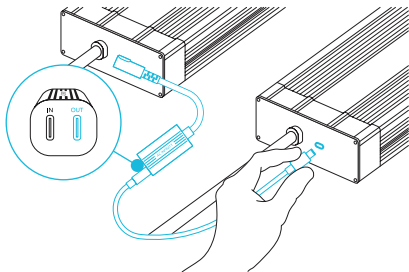

STEP 4

Connect the daisy-chain adapter's INPUT port to the schedule controller using the 2 ft. or 10 ft. M-M UIS cord.

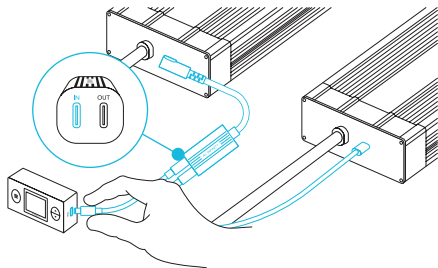

CONTROLLER MOUNTING

STEP 1 — WALL MOUNTING

Locate a spot free of obstruction and secure the anchor into your wall. Twist the wood screw into the anchors.

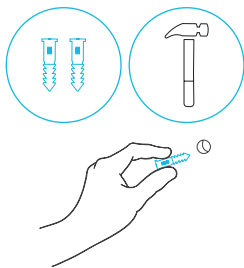

STEP 2 — WALL MOUNTING

Hang the controller by the screw using the holes on the backside.

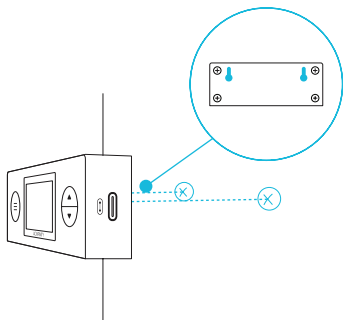

CONTROLLER MOUNTING

MAGNET MOUNTING

Magnetically mount the schedule controller onto the frame of your grow light or a controller mounting plate.

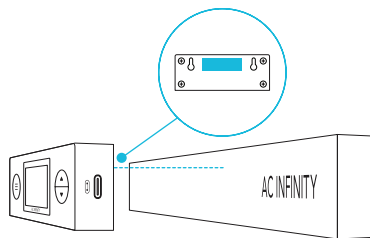
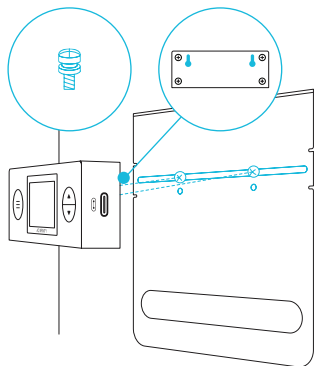

PLATE MOUNTING*

Screw the controller plate bolts into the slot or mounting holes at the upper half of the plate.

Hang the controller by the bolts using the holes on the backside.



*Controller plate not included

STARTER GUIDE





The chart below lists the coverage area of each grow light size in each growth stage. The supplemental CO₂ column refers to sealed grow spaces that use a CO₂ enrichment system with a 1200+ PPM.

AREA COVERAGE (FT.)	Vegetative Stage	Flowering Stage	Supplemental CO ₂
IONFRAME EVO3	3 x 5	2 x 4	1 x 3
IONFRAME EVO4	4 x 4	3 x 3	2 x 2
IONFRAME EVO6	5 x 5	4 x 4	3 x 3
IONFRAME EVO8	6 x 6	5 x 5	4 x 4
IONFRAME EVO10	7 x 7	6 x 6	5 x 5

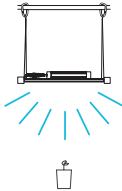

STARTER GUIDE

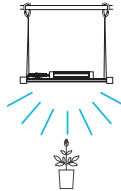
The charts below offer suggested mounting heights and light intensities for each stage in the growing process of your preferred method. These factors will vary based on the plant you are growing. In dynamic placement, "height" refers to distance from the canopy (tip of the plant).

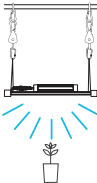
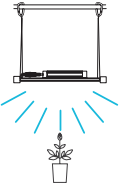
STATIC PLACEMENT	Seedling Stage	Vegetative Stage	Flowering Stage
Height	Peak	Peak	Peak
Intensity	100%	100%	100%
			
DYNAMIC PLACEMENT	Seedling Stage	Vegetative Stage	Flowering Stage
Height	1.5 ft.	1.5 ft.	1.5 ft.
Intensity	40%	80%	100%
			

UIS™ PLATFORM

The UIS™ platform enables you to connect a single central controller with several grow devices simultaneously. By creating this fully integrated system, you can power and program all your devices together or separately for optimized grow tent management.

Your grow system can be regulated using your controller hub or remotely on the AC Infinity app (paired with compatible controllers), where you will have access to automation programming and climate data.

You can also connect your favorite grow light and outlet device to integrate them into the UIS platform using our RJ11/12 adapter and control plug module.

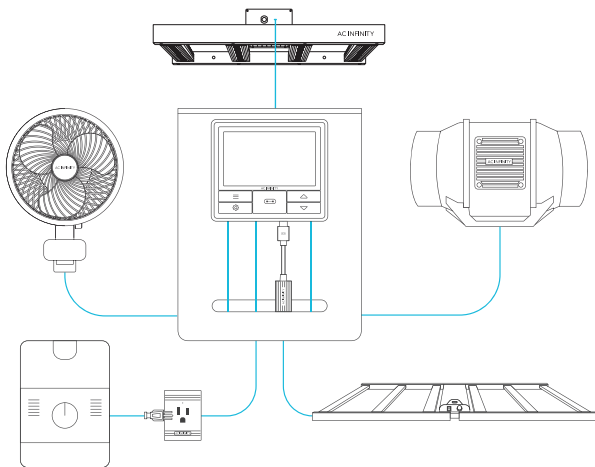

Central controller and grow devices will be sold separately and may still be in development at the time of your purchase of this product.

UIS™ COMPATIBILITY

MOLEX ADAPTER*

Use the included Molex adapter to plug inline fans with 4-pin Molex connectors into this controller. Plug your fan's Molex connector into the adapter. Then plug the adapter into the controller.

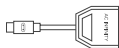

UIS M - 4PIN F
ADAPTER

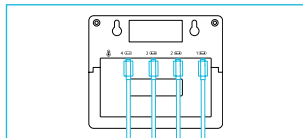

EXTENSION CABLE

Use male-to-male UIS extension cords to connect devices with female UIS ports at an extended range from your controller. Included with UIS-compatible devices.

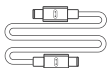

UIS M - M
CORD

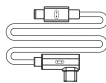

UIS M - M
CLIP FAN CORD

EXPANSION SPLITTER*

The expansion splitter will allow you to connect 4 devices with a single port and can support additional splitters to create up to 3 tiers of expansion ports (up to 64 units supported with the use of 20 splitters). Intended for exclusive use with AC Infinity controllers with UIS ports.

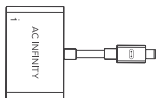

UIS M - F
4 PORT SPLITTER

*Not included

ADDING MORE LIGHTS



AC Infinity UIS controllers are equipped with multiple ports to add more grow lights and share the same programming. Refer to the diagram below to learn how to connect additional units.

Smart grow light controllers can program light intensity levels and scheduled activations of all grow lights plugged into its UIS ports.

An expansion dongle (sold separately) will allow you to connect additional grow lights past the number of units your controller can support.

Multi-Light Connection

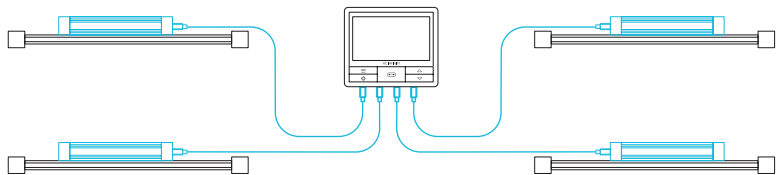

*Smart controller and dongle sold separately.

ADDING MORE LIGHTS

DAISY-CHAINING

Each of the included controller's ports can support up to 16 grow lights using a daisy-chain adapter*. All grow lights chained together must be from the same series.

Plug the male end of the daisy-chain adapter into your device.

Connect your UIS controller to the daisy-chain adapter's INPUT port using a M-M connector cord. Using an extension cord, attach the daisy-chain adapter's OUTPUT port to another adapter's INPUT port. You can also link the OUTPUT port to another UIS device to end the chain.

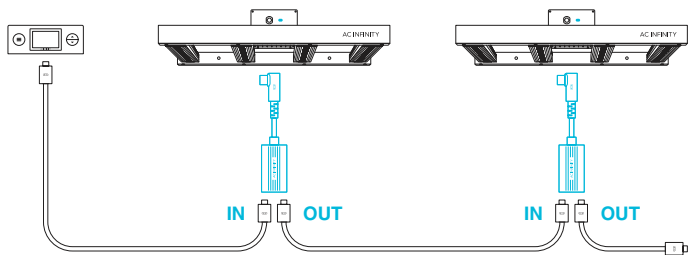
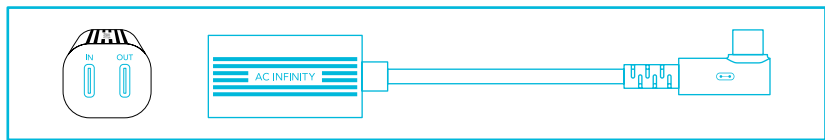

*Only included with the IONFRAME EVO10

PROGRAMMING

1. MODE BUTTON

Cycles through each of the controller modes: OFF, ON, SCHEDULE, SUNSET/RISE, and CLOCK. Holding this button will lock the controller; pressing this button afterwards will turn off the display.

2. UP/DOWN BUTTON

Adjusts the setting of your current mode.

3. CURRENT TIME

Displays the current time. The internal battery sustains the clock so it does not default to 00:00 if power is cut off.



4. USER SETTING

Displays the grow light's intensity level as well as countdown timers of the Schedule modes.

5. CONTROLLER MODE

Displays the controller's current mode. Pressing the mode button cycles through the available modes.

6. LOCK ICON

Displays the controller lock status of the controller.

PROGRAMMING

CONTROLLER MODES

Pressing the mode button will cycle through the controller's available programming modes and settings: OFF, ON, SCHEDULE, SUNSET/RISE, and CLOCK.

OFF MODE

Your grow light will not activate while in this mode. The intensity level set here establishes the minimum intensity level in the SCHEDULE mode. When it is triggered to turn off, it will instead shine at the level set here.



ON MODE

Your grow light will activate to the intensity level set here. The ON mode also serves as the maximum intensity level the SCHEDULE mode will shine in.

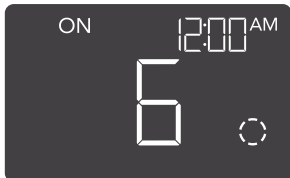

PROGRAMMING

SCHEDULE MODE (ON & OFF)

Sets an on clock-time and an off clock-time schedule for your grow light to follow daily.

Press the up or down button to first set up an on clock-time to turn your grow light on, then press the mode button to set an off clock-time to turn your grow light off. Please be sure to set the current clock time under settings.

When your grow light turns on, it will run at your set maximum level. When your grow light turns off, it will run at your set minimum level.

The countdown will begin if no buttons are pressed for 5 seconds. Leaving the SCHEDULE mode while the countdown is running will pause it until you return to this mode.

Resetting the off clock-time will result in your grow light staying on until you actively turn it off.



The grow light will shine at your set OFF mode level while it is off, and at your set ON mode level while it is on.

PROGRAMMING

SUNSET/RISE SETTING

Sets a sunrise and sunset time for your grow light to brighten and dim, respectively. This setting only applies to SCHEDULE mode.

Press the up or down button to set a duration between 0:00 – 6:00 hours for your grow light to brighten and dim. For this setting to activate, you must return to SCHEDULE mode.

When your grow light is triggered to turn on, it will begin brightening up to your maximum level. It will then begin dimming down to your minimum level before it is triggered to turn off.

In this example, your grow light is set to turn on at 6:00 AM and turn off at 6:00 PM. The SUNSET/RISE setting is set to 2:00 hours. At 6:00 AM, your grow light will begin gradually brightening until it reaches your maximum level at 8:00 AM. Your grow light will then begin dimming at 4:00 PM until it reaches your minimum level at 6:00 PM.

You may deactivate this mode by setting the SUNSET/RISE timer to 0:00.

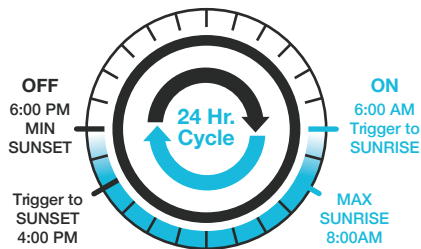

The grow light will shine at your set OFF mode level while it is off, and at your set ON mode level while it is on.

PROGRAMMING

CLOCK MODE

Adjusts the current clock time. Use the up and down buttons to adjust the time. Once you cycle through 12:00 each time, the units will automatically change to AM or PM.

The clock time is located at the center of the display and the upper right hand corner.



TOGGLING THE DISPLAY

Lock the controller by holding the mode button.

Press the mode button to turn the display off. Pressing the mode button again will turn the display back on.

Programs will still run in the background while the LCD screen is off.

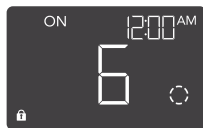

HOLD + 



PRESS + 

OTHER SETTINGS

FACTORY RESET

Holding the mode and up/down buttons together for 5 seconds will reset your controller and restore factory settings. This will clear all user set parameters of each controller mode and setting.

HOLD +



RESET TO OFF/DEFAULT

Holding the up and down buttons together for 2 seconds will reset the value of your current mode to its default setting. In SCHEDULE mode, pressing the up or down button after resetting will return it to its previous value.

HOLD +



CONTROLLER LOCK

Holding the mode button will lock the controller in your current mode. While your controller is locked, no parameters may be adjusted nor will you be able to switch modes. Holding the mode button again will unlock the controller.

HOLD +



HIDE SCREEN

Lock the controller so no settings can be adjusted. See above. Then press the mode button to turn the display off. Pressing the mode button again will turn the display back on. Programs will still run in the background while the LCD screen is off.

PRESS +



AC INFINITY PRODUCTS

Advance Grow Tents

The CLOUDLAB series is a line of grow tents designed to create ideal growing conditions and facilitate indoor plant cultivation year-round. Features 2000D thick oxford canvas lined with inner diamond patterned mylar that maximizes grow light luminosity, and a reinforced frame with 150 lb. weight capacity. Includes a mounting plate to install your AC Infinity controller onto.

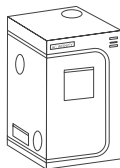

Inline Duct Fans

The CLOUDLINE series is a line of duct fans designed to quietly ventilate AV rooms and closets, as well as various DIY air circulation and exhaust projects. Features a thermal controller with intelligent programming that will automatically adjust duct fan speeds in response to changing temperatures.

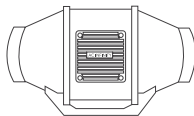

Circulator Clip Fans

The CLOUDRAY series is a line of clip fans designed to provide precise air circulation for all stages of a plant's growth cycle. Features digital controls to achieve ten speed levels, as well as a heavy-duty clamp constructed to tightly grip onto grow tent poles of all sizes.



Discover the latest innovations in environmental controls at acinfinity.com

WARRANTY

This warranty program is our commitment to you, the product sold by AC Infinity will be free from defects in manufacturing for a period of two years from the date of purchase. If a product is found to have a defect in material or workmanship, we will take the appropriate actions defined in this warranty to resolve any issues.

The warranty program applies to any order, purchase, receipt, or use of any products sold by AC Infinity or our authorized dealerships. The program covers products that have become defective, malfunctioned, or expressively if the product becomes unusable. The warranty program goes into effect on the date of purchase. The program will expire two years from the date of purchase. If your product becomes defective during that period, AC Infinity will replace your product with a new one or issue you a full refund.

The warranty program does not cover abuse or misuse. This includes physical damage, submersion of the product in water, incorrect installation such as wrong voltage input, and misuse for any reason other than intended purposes. AC Infinity is not responsible for consequential loss or incidental damages of any nature caused by the product. We will not warrant damage from normal wear such as scratches and dings.

Contact our dealers department at dealers@acinfinity.com or (626) 838-4656 for more information about our dealers and distributors program. Contact our customer service department at support@acinfinity.com or 626-923-6399 for product and warranty assistance. Our business hours are Monday through Friday, 9:00 am to 5:00 pm PST.



If you have any issues with this product, contact us and we'll happily resolve your problem or issue a full refund!

COPYRIGHT © 2023 AC INFINITY INC. ALL RIGHTS RESERVED

No part of the materials including graphics or logos available in this booklet may be copied, photocopied, reproduced, translated or reduced to any electronic medium or machine readable form, in whole or in part, without specific permission from AC Infinity Inc.

Samsung is a trademark of SAMSUNG ELECTRONICS CO., LTD.

www.acinfinity.com