



PROGRAMMING MANUAL

For Technical Service, contact Bunn-O-Matic Corporation at 1-800-286-6070.

Bunn-O-Matic Corporation
Post Office Box 3227, Springfield, Illinois 62708-3227
Phone (217) 529-6601 | Fax (217) 529-6644

BUNN-O-MATIC COMMERCIAL PRODUCT WARRANTY

Bunn-O-Matic Corp. ("BUNN") warrants the BUNN Crescendo as further described below for a warranty period of 1 year parts and labor.

These warranty periods run from the date of installation. BUNN warrants that the equipment manufactured by it will be commercially free of defects in material and workmanship existing at the time of manufacture and appearing within the applicable warranty period. This warranty does not apply to any equipment, component or part that was not manufactured by BUNN or that, in BUNN's judgment, has been affected by misuse, neglect, alteration, improper installation or operation, improper maintenance or repair, non periodic cleaning and descaling, equipment failures related to poor water quality, damage or casualty. This warranty is conditioned on the Buyer 1) giving BUNN prompt notice of any claim to be made under this warranty by telephone at (217) 529-6601 or by writing to Post Office Box 3227, Springfield, Illinois 62708-3227; 2) if requested by BUNN, shipping the defective equipment prepaid to an authorized BUNN service location; and 3) receiving prior authorization from BUNN that the defective equipment is under warranty. Additionally, the following is excluded from the warranty period:

Warranty Exclusions:

- Parts such as, but not limited to, hoppers and lids, drip trays, and plastic parts damaged due to improper handling or cleaning agents.
- Replacement of wear items such as, but not limited to, O-rings, gaskets, silicone tubes, hoses, and valve seats.
- Repairs made necessary due to poor water quality such as dispense valves, water inlet valves, scaling in the steam or hot water boilers. (Total Hardness recommended range of 4-7 gpg constant).
- Improper voltage. (See equipment operations manual for voltage specifications).
- Failure to use BUNN approved cleaning supplies constitutes improper maintenance.
- Failure to have required preventive maintenance performed by BUNN technician or authorized espresso service provider.
- Parts replaced under the terms of this warranty carry the remainder on the machine's parts warranty term, or 60 days, whichever is greater.
- Drink quality issues from machine failures related to product formulation or product characteristics.

THE FOREGOING WARRANTY IS EXCLUSIVE AND IS IN LIEU OF ANY OTHER WARRANTY, WRITTEN OR ORAL, EXPRESS OR IMPLIED, INCLUDING, BUT NOT LIMITED TO, ANY IMPLIED WARRANTY OF EITHER MERCHANTABILITY OR FITNESS FOR A PARTICULAR PURPOSE. The agents, dealers or employees of BUNN are not authorized to make modifications to this warranty or to make additional warranties that are binding on BUNN. Accordingly, statements by such individuals, whether oral or written, do not constitute warranties and should not be relied upon. If BUNN determines in its sole discretion that the equipment does not conform to the warranty, BUNN, at its exclusive option while the equipment is under warranty, shall either 1) provide at no charge replacement parts and/or labor (during the applicable parts and labor warranty periods specified above) to repair the defective components, provided that this repair is done by a BUNN Authorized Service Representative; or 2) shall replace the equipment or refund the purchase price for the equipment.

THE BUYER'S REMEDY AGAINST BUNN FOR THE BREACH OF ANY OBLIGATION ARISING OUT OF THE SALE OF THIS EQUIPMENT, WHETHER DERIVED FROM WARRANTY OR OTHERWISE, SHALL BE LIMITED, AT BUNN'S SOLE OPTION AS SPECIFIED HEREIN, TO REPAIR, REPLACEMENT OR REFUND. In no event shall BUNN be

liable for any other damage or loss, including, but not limited to, lost profits, lost sales, loss of use of equipment, claims of Buyer's customers, cost of capital, cost of down time, cost of substitute equipment, facilities or services, or any other special, incidental or consequential damages.

392, A Partner You Can Count On, Air Infusion, AutoPOD, AXIOM, BrewLOGIC, BrewMETER, Brew Better Not Bitter, BrewWISE, BrewWIZARD, BUNN Espresso, BUNN Family Gourmet, BUNN Gourmet, BUNN Pour-O-Matic, BUNN, BUNN with the stylized red line, BUNNlink, Bunn-O-Matic, Bunn-O-Matic, BUNNserve, BUNNSERVE with the stylized wrench design, Cool Froth, DBC, Dr. Brew stylized Dr. design, Dual, Easy Pour, EasyClear, EasyGard, FlavorGard, Gourmet Ice, Gourmet Juice, High Intensity, iMIX, Infusion Series, Intellisteam, My Café, Phase Brew, PowerLogic, Quality Beverage Equipment Worldwide, Respect Earth, Respect Earth with the stylized leaf and coffee cherry design, Safety-Fresh, vemycoffee.com, Scale-Pro, Silver Series, Single, Smart Funnel, Smart Hopper, SmartWAVE, Soft Heat, SplashGard, The Mark of Quality in Beverage Equipment Worldwide, ThermoFresh, Titan, trifacta, TRIFECTA (stylized logo), Velocity Brew, Air Brew, Beverage Bar Creator, Beverage Profit Calculator, Brew better, not bitter., Build-A-Drink, BUNNSource, Coffee At Its Best, Cyclonic Heating System, Daypart, Digital Brewer Control, Element, Milk Texturing Fusion, Nothing Brews Like a BUNN, Picture Prompted Cleaning, Pouring Profits, Signature Series, Sure Tamp, Tea At Its Best, The Horizontal Red Line, Ultra are either trademarks or registered trademarks of Bunn-O-Matic Corporation. The commercial trifacta® brewer housing configuration is a trademark of Bunn-O-Matic Corporation.

CONTENTS

WARRANTY	2
PROGRAMMING THE DISPENSER.....	4
DOOR SAFETY INTERLOCK	4
OPERATING CONTROLS AND INTERFACE	
Switch in Normal Mode.....	5
Switch in Program Mode.....	5
Modifying the Touch Switch Functions.....	6
Single Cup Mode	6
Disabling a Dispense Switch	6
Default Recipe Settings	7
Creating A “Custom” Beverage.....	8
Set Espresso Shots	8
Recipe Setup	9,10
Touchless Sensitivity Selection Options	11,12
Confirm Beverage Screens.....	12
Default Machine Settings and Ranges	13
Accessing and Modifying Machine Settings	14,15
Change Display Language	16
Energy Saver Mode	16
Software Setup for Through Counter Option	17
Locks / Disables.....	17
Draining Hot Water Tanks	18
Password Protection.....	19
Importing and Exporting Recipes	20,21
Importing and Exporting Machine Settings.....	22,23
Updating Software	24
Changing The Switch Graphics	25
PROGRAM FLOW CHART	
Build a Beverage - Standard Beverage Selection.....	26
Build a Beverage - Custom Beverage Selection.....	27
USB Import / Export Screen Menu Flow	28
RINSE/RUN/PROGRAM Switch to RINSE.....	29
MENU GLOSSARY	30,31,32,33

PROGRAMMING THE DISPENSER

The following function screens are in order of appearance. Each screen will have instructions on how to access, and the procedures to program the various functions of the dispenser. To enable programming, place the “NORMAL/PROGRAM/RINSE” switch in the “PROGRAM” position.

IMPORTANT PROGRAMMING NOTES - READ CAREFULLY -

To exit the programming mode at any time, press and release the exit (center) pad located on the front switch panel. The display will return to the PROGRAM HOME SCREEN.

If none of the five programming switches are pressed within a time period during the setup of the dispenser, the programming of the function screen that is being set will be exited and the display will return to the PROGRAM HOME SCREEN.

PROGRAMMING SWITCHES

Using the menu-driven display (MAIN SCREEN) on the front of dispenser, the operator has the ability to alter or modify various functions of the dispenser. This allows for precise dispensing of various flavors of powdered products.

Programming of dispenser is achieved by entering a certain function, then, by use of programming switches, the operator can customize the dispensing process to their specifications.

To access the programming mode, and to scroll through different function screens, the programming switches shown are used. There are five switches that will be used for setup of the dispenser.

NORMAL/PROGRAM/RINSE Switch:

NORMAL: Allows all dispenser functions. Must be in this position for dispensing.

PROGRAM: Allows access to program menus using touch pad and LCD screen.

RINSE: Pressing dispense button on front door will dispense dilution water and power whipper motor for ten seconds.



DOOR SAFETY INTERLOCK

The dispenser is equipped with a door interlock safety switch, which prevents the operator from being exposed to the moving parts of the espresso brewer if the door is open.

The switch may be overridden by a qualified service technician by inserting the service key, (BUNN PN 51953.0001) into the opening of the mixing chamber panel, then turn about 15 degrees to position, as shown in Figure 2.

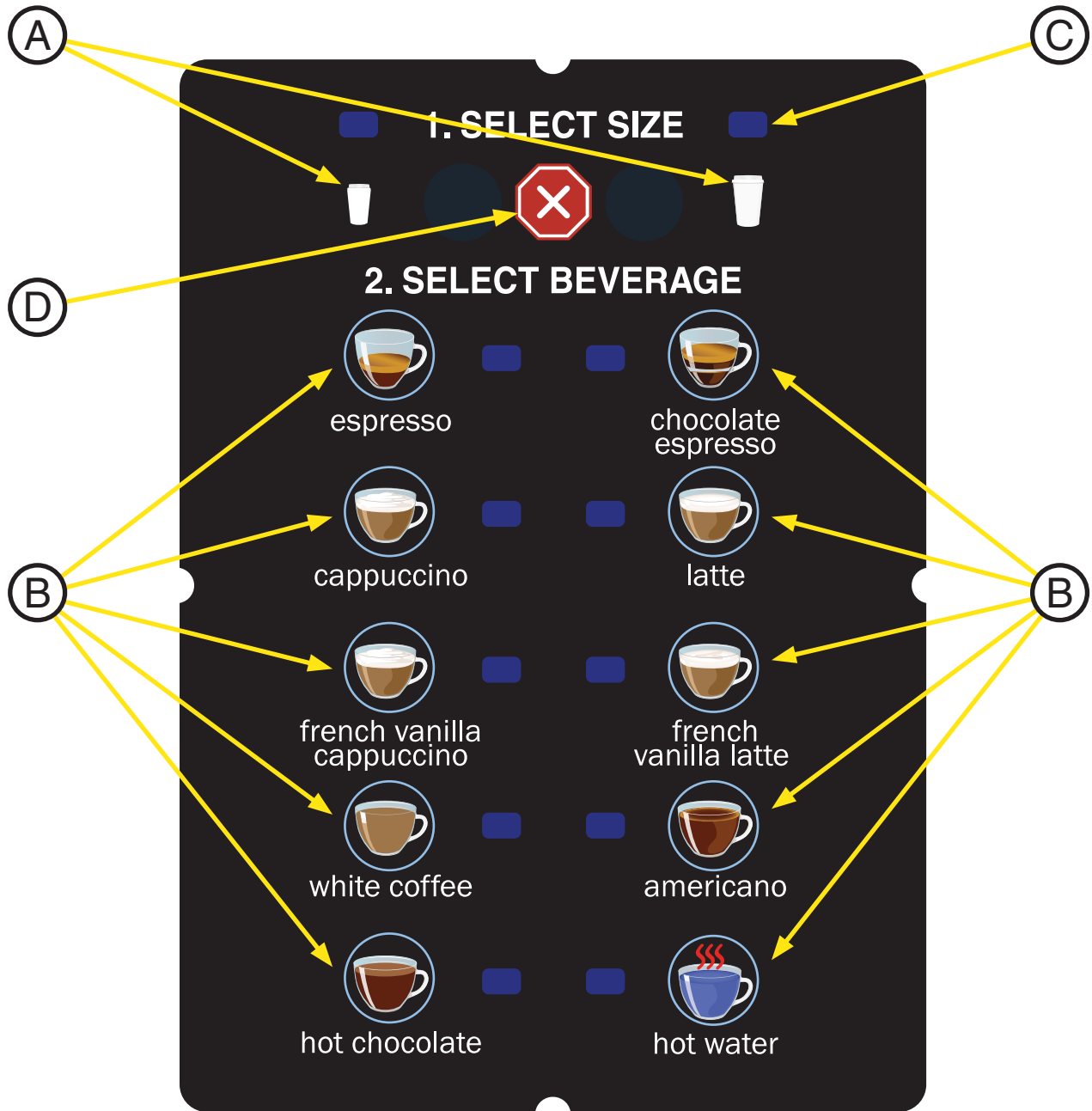

Figure 2

OPERATING CONTROLS AND INTERFACE

WITH SWITCH IN NORMAL MODE

- A. Cup Size Buttons:** Momentarily pushed to select beverage size to dispense.
- B. Dispense Buttons:** Momentarily pushed to dispense selected beverage.
- C. LED indicators:** Illuminates when the adjoining button has been selected.
- D. Stop button:** Pressing the stop button during dispensing will stop the dispense sequence.



WITH SWITCH IN PROGRAM MODE

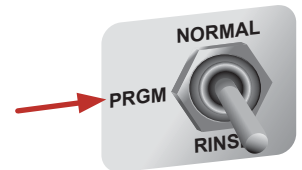
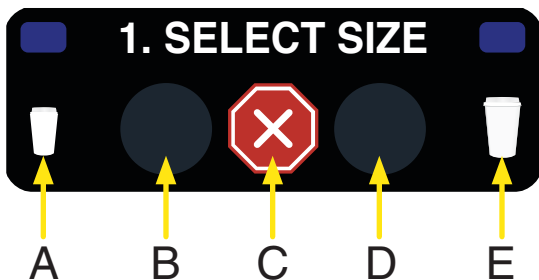

- A. Return to previous menu
- B. Increment display value negative (-), Select, No
- C. Exit program mode / Stop Dispense Cycle
- D. Increment display value positive (+), Select, Yes
- E. Enter program mode and advance to next menu

OPERATING CONTROLS AND INTERFACE

MODIFYING THE TOUCH SWITCH FUNCTIONS

The function of the touch switch can be modified in three different ways:

1. Set for single cup size dispensing.
2. Disable a dispense switch.
3. Create a CUSTOM or ESPRESSO only beverage.

Single Cup Mode

When the SINGLE cup size beverage mode is selected, the large and small cup size buttons are disabled. To dispense a beverage, press only the dispense button of the beverage desired. The option to select which beverage size is used can be done when creating a custom recipe or espresso dispense.

TIP: A display graphic for single cup dispensing is available for purchase from BUNN.

DISABLING A DISPENSE SWITCH

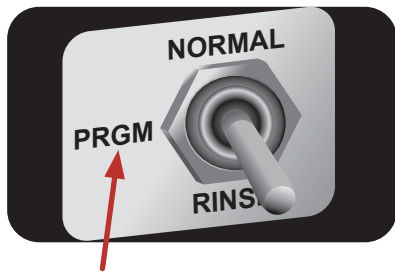

STEP 1

- Set the toggle switch to Program mode.

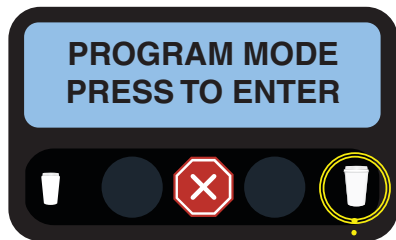

STEP 2

- Advance to the RECIPE SETUP screen.



STEP 3

- Press SELECT.

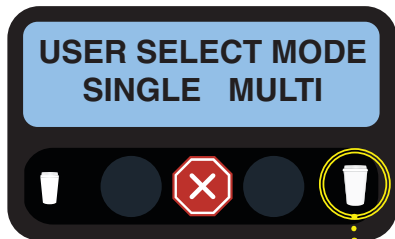

STEP 1

- Navigate to the switch # to be disabled.

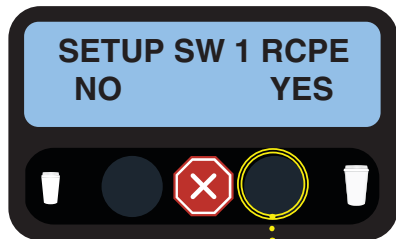

STEP 2

- Press SELECT.

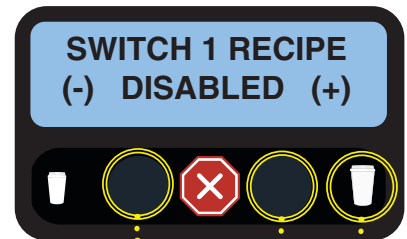

STEP 3

- Navigate to DISABLED.
- Press the EXIT switch to return.

OPERATING CONTROLS AND INTERFACE

Default Recipe Settings

Multi-Drink	Overlay Label	Recipe	Dispense Time		Espresso Shot?	Product Assignment		Product Strength		Dispense Order	
			Small	Large		1st	2nd	1st Product Portion %	1st		2nd
Switch 1	Espresso	ESPRESSO			yes						Coffee Only
Switch 2	Chocolate Espresso	CUSTOM	5.8	11.6	yes	Center		100%	85%		Coffee and Powder
Switch 3	Cappuccino	CUSTOM	5.8	11.6	yes	Left		100%	85		Powder then Coffee
Switch 4	Latte	CUSTOM	5.8	11.6	yes	Left		100%	95		Coffee and Powder
Switch 5	French Vanilla Cappuccino	CUSTOM	5.8	11.6	yes	Right		100%	85		Powder then Coffee
Switch 6	French Vanilla Latte	CUSTOM	5.8	11.6	yes	Right		100%	95		Coffee and Powder
Switch 7	White Coffee (Coffee with cream)	CUSTOM	5.8	11.6	yes	Left	Dilution	15%	85		Coffee and Powder
Switch 8	Americano (Coffee)	CUSTOM	5.8	11.6	yes	Dilution		100%			Coffee and Powder
Switch 9	Hot Chocolate	CUSTOM	5.8	11.6	no	Left	Center	20%	85	85	Powder Only
Switch 10	Hot Water	CUSTOM	5.8	11.6	no	Dilution		100%			Powder Only

Set Espresso Shots		Small	Large
Espresso Grind	Seconds	3.5	5
Dry Tamp	Percent	60	60
Pre Infusion	Seconds	1	1
Dwell Time	Seconds	2	1.5
Brew Volume	Flow Tics	95	190

OPERATING CONTROLS AND INTERFACE

CREATING A “CUSTOM” BEVERAGE

A “CUSTOM” beverage may be edited/created for any dispense switch location. It is recommended that the touch switch graphic insert be replaced with one which matches the beverage reassignments made in this mode. All settings can be adjusted to preference.

► Set Espresso Shots

The sub-menus for adjusting an espresso shot are located under this option.

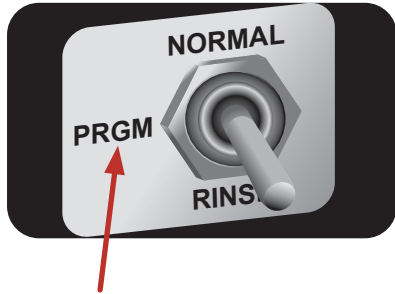

STEP 1

- Set the toggle switch to PROGRAM MODE.

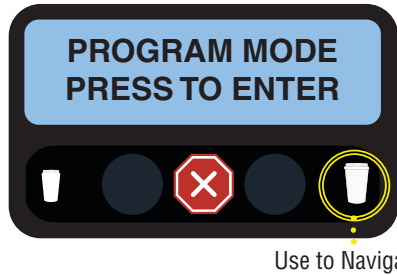

Use to Navigate

STEP 2

- Advance to the SET ESPRESSO SHOTS screen.



Use to Select

STEP 3

- Press SELECT.

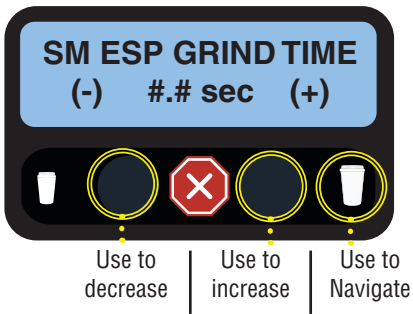

Use to decrease | Use to increase | Use to Navigate

STEP 4

- Sets the grinder run time for a small spresso shot.
- Navigate to the next setting.

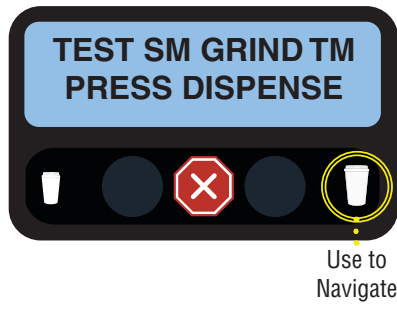

Use to Navigate

STEP 5

- Press a dispense switch to perform a catch test for a grind.
- Navigate to the next setting.

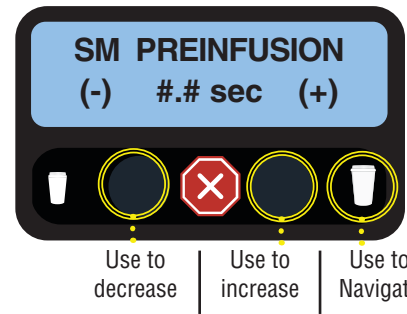

Use to decrease | Use to increase | Use to Navigate

STEP 6

- Sets the espresso pump run time for pre-infusion of tamped coffee. Zero seconds for no pre-infusion.
- Navigate to the next setting.

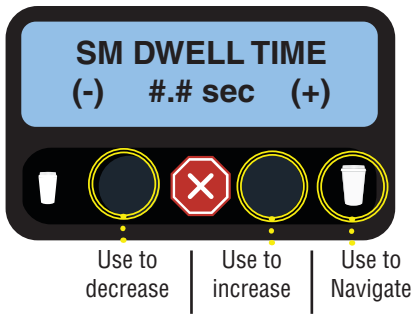

Use to decrease | Use to increase | Use to Navigate

STEP 7

- Sets the dwell time for a small espresso.
- Navigate to the next setting.

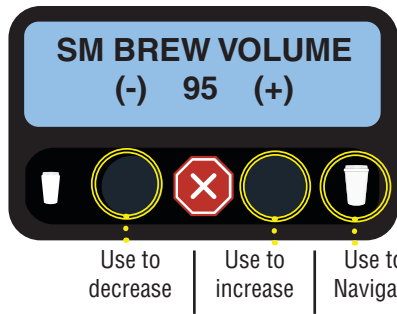

Use to decrease | Use to increase | Use to Navigate

STEP 8

- Sets the total brew volume for a small espresso shot. The numeric value is flow ticks.
- Navigate to the next setting.

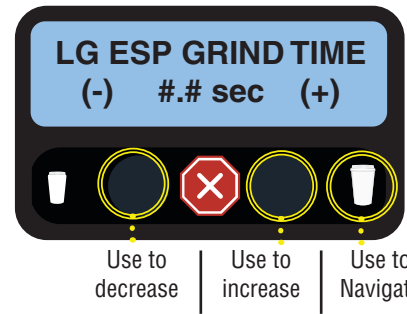

Use to decrease | Use to increase | Use to Navigate

STEP 9

- The settings will repeat for the large espresso shot.

OPERATING CONTROLS AND INTERFACE

CREATING A "CUSTOM" BEVERAGE (continued)

► Recipe Setup

The sub-menus for adjusting recipes are located under this option.



STEP 1

- Set the toggle switch to Program mode.

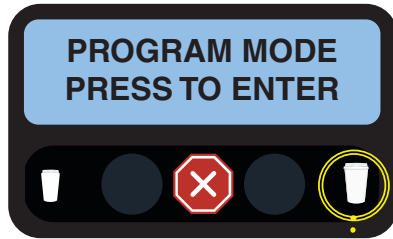

Use to Navigate

STEP 2

- Advance to the RECIPE SETUP screen.



Use to Select

STEP 3

- Press SELECT.

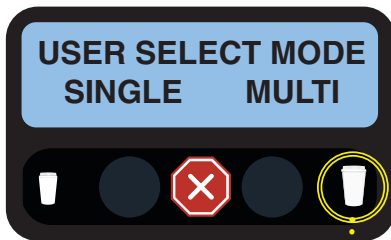

Use to Navigate

STEP 4

- Single mode will only allow one size beverage. Multi-drink mode must be selected for setting up small and large beverages.
- Navigate to the next setting.



Use to select. | Use to Navigate

STEP 5

- You can navigate to any switch to make a custom beverage.
- Press SELECT.



Use to Scroll | Use to Scroll | Use to Navigate

STEP 6

- Navigate to BEVERAGE to create a CUSTOM beverage recipe.
- Press navigate to enter the next setting.

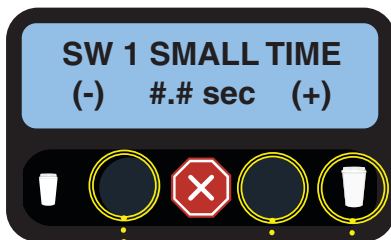

Use to decrease | Use to increase | Use to Navigate

STEP 7

- Sets the dispense time for a small beverage.
- Single cup mode will have small or large to select from.
- Navigate to the next setting.

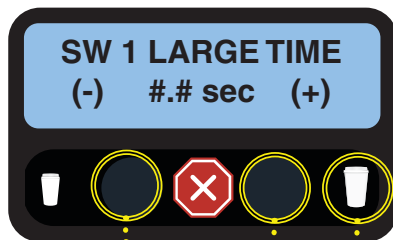

Use to decrease | Use to increase | Use to Navigate

STEP 8

- Sets the dispense time for a Large beverage.
- Single cup mode will have small or large to select from.
- Navigate to the next setting.



Use to select | Use to select | Use to Navigate

STEP 9

- Does beverage need an ESPRESSO SHOT? If YES, it will use the corresponding size set for single touch or for the size button selected in Multi.
- Navigate to the next setting.

OPERATING CONTROLS AND INTERFACE

CREATING A “CUSTOM” BEVERAGE (continued)

► Recipe Setup (continued)

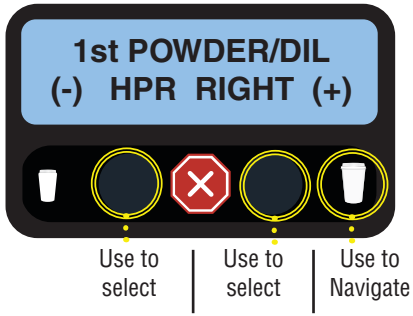

STEP 10

- Options are any of three hoppers or dilution. Cannot choose “NONE”.
- Navigate to the next setting.

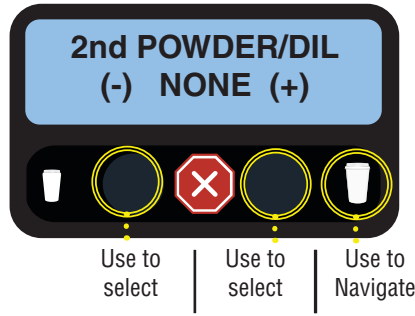

STEP 11

- Options are any of three hoppers or dilution. “None” can be selected.
- Navigate to the next setting.

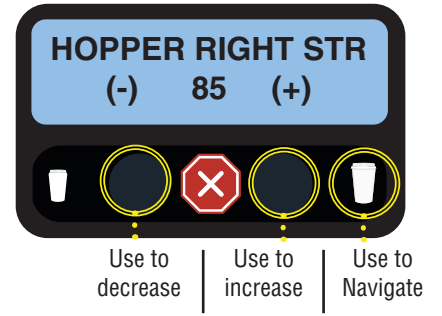

STEP 12

- Sets the amount of product used for the recipe that comes from the hopper. If a hopper is not used in the recipe, this screen will not appear.
- Navigate to the next setting.

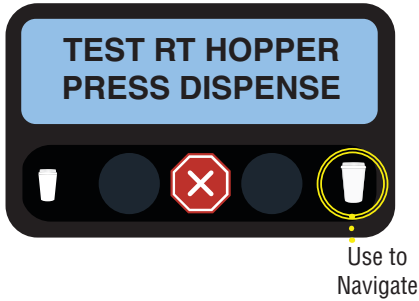

STEP 13

- This will provide a catch test to see how much product dispenses from the hopper.
- Navigate to the next setting.

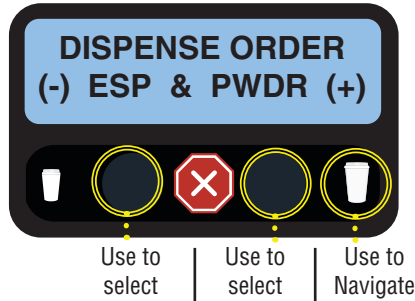

STEP 14

- Choose the order in which the ingredients dispense.
- Navigate to the next setting.

OPERATING CONTROLS AND INTERFACE

TOUCHLESS SENSITIVITY SELECTION OPTIONS

The Sensitivity option is available for both **TOUCH** and **TOUCHLESS** operation modes. The recommended initial setting for **TOUCH** is “NORMAL”, and the recommended initial setting for **TOUCHLESS** is “HIGH”.

NOTE: Your Crescendo must be fitted with a Gen 2 PCAP with software version 01.20 or higher, and the main I/O board with software version 00.45 or higher to modify the **Touch Settings** on this machine. Go to www.bunn.com to view **Crescendo Programming Manual** or **BUNN Online Learning Center** for more information on updating.

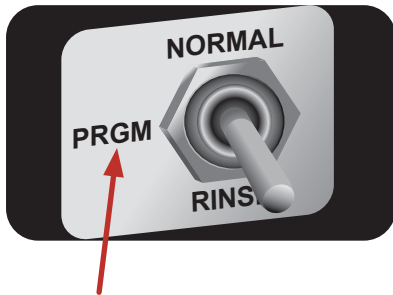

STEP 1

- Set the toggle switch on inside of the door to Program mode.

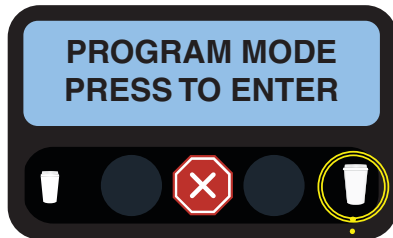

Use to Navigate

STEP 2

- Advance to the Calibration screen.

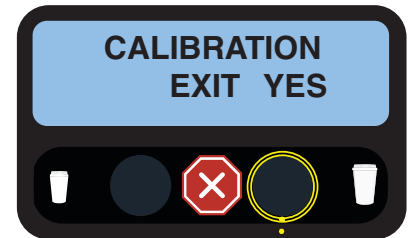

Use to Select

STEP 3

- Press YES to enter the Calibration sub-menu.
- Navigate through the sub-menu until you see a screen that says TOUCH SETTINGS.



Use to Select

STEP 4

- Press YES to enter the TOUCH SETTINGS sub-menu.

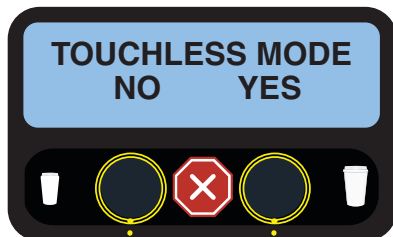

Use to Select Use to Select

STEP 5

- Press YES to enable TOUCHLESS dispense mode.
- Or, press NO to enable TOUCH dispense mode.
- Press large cup to navigate to next option screen.

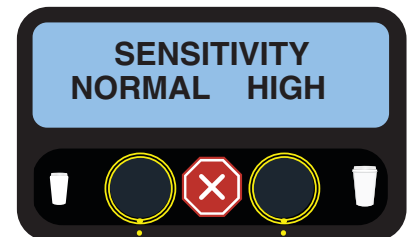

Use to Select Use to Select

STEP 6

- Select the sensitivity level for the TOUCHLESS or TOUCH mode chosen on previous screen.
NOTE: It is recommended to try “Normal” for TOUCH and “High” for TOUCHLESS.
- Press large cup to navigate to next option screen.

OPERATING CONTROLS AND INTERFACE

TOUCHLESS SENSITIVITY SELECTION OPTIONS (continued)

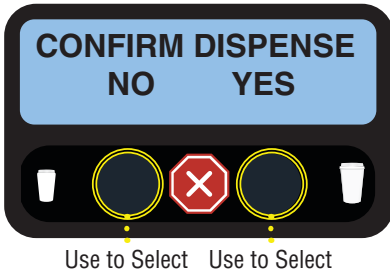

STEP 7

- The CONFIRM DISPENSE screen allows you to determine if you want to require the user to press the beverage select button twice to get a beverage to dispense.
- If YES is chosen; the selected beverage button will flash its LED while waiting for the user to press it again to begin the dispense process.
- Press large cup to navigate to next option screen.

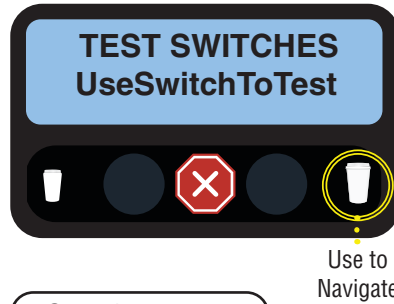

STEP 8

- This screen allows you to try the 10 beverage dispense buttons with the TOUCH or TOUCHLESS mode and the selected Sensitivity adjustment (Normal to High), to see how the touch panel responds.
- Once done, press the large cup to navigate to next option screen.
- If you want to try more Sensitivity or Mode options; press the small cup to navigate backwards.



CONFIRM BEVERAGE SCREENS (when activated)

Screen text examples for multi-touch and single touch operation of the Crescendo machine.

If the CONFIRM BEVERAGE screen is active, it will go there after the beverage is selected and flash the beverage LED until the user selects the beverage again.

If the CONFIRM DISPENSE option is not active, then the beverage should begin to dispense as soon as the beverage key is selected the first time.

The CONFIRMATION screen will time out after 20 seconds of inactivity, and will also cancel out if the user presses any other buttons on the touch panel.

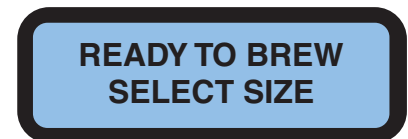

Multi-Touch Selection Screens

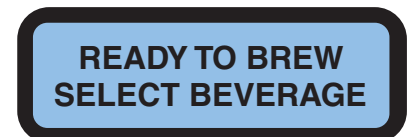

Single Touch Selection Screen

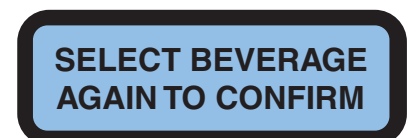

Confirm Beverage Screen

OPERATING CONTROLS AND INTERFACE

Default Machine Settings and Ranges

Program Mode	Unit	Default	Min	Max
TEMPERATURE				
Powder Tank Temp	Degrees F	180	160	190
Powder Ready Temp	Degrees F	-30	-10	-40
Espresso Tank Temp	Degrees F	215	190	218
Espresso Ready Temp	Degrees F	-15	-5	-20
CALIBRATION				
Select Units	List	Metric		
Tank Refill Threshold	ADC	775	100	1020
Auger Delay	Seconds	0.5	fixed	fixed
Whipper Delay	Seconds	0.5	fixed	fixed
Pump Start Delay	Seconds	0.1	fixed	fixed
Water Off Delay	Seconds	2	fixed	fixed
ESP Threshold	ADC	192	fixed	fixed
Piston Home Threshold	ADC	192	fixed	fixed
Bean Hopper Threshold	ADC	150	35	300
Pre Heat Espresso Group	y/n	NO		
Set Pre Heat Time	Minutes	5	5	30
Set Pre Heat Volume	Tics	30	fixed	fixed
Set Drain Time	Seconds	10	fixed	fixed
Touchless Mode	Y/N	NO		
Sensitivity	NORMAL/HIGH	NORMAL		
Confirm Dispense	Y/N	NO		
SET ESPRESSO SHOTS				
Small Espresso Grind Time	Seconds	3.5	2	10
Small Dry Tamp	Percent	60	fixed	fixed
Small Tamp Time	Seconds	2	fixed	fixed
Small Pre Infusion	Seconds	1	0	2
Small Dwell Time	Seconds	2	1	7
Small Brew Volume	Tics	95	50	300
Small Wet Squeeze	Percent	100	fixed	fixed
Large Espresso Grind Time	Seconds	5	2	10
Large Dry Tamp	Percent	60	fixed	fixed
Large Tamp Time	Seconds	2	fixed	fixed
Large Pre Infusion	Seconds	1	0	2
Large Dwell Time	Seconds	1.5	1	7
Large Brew Volume	Tics	190	50	300
Large Wet Squeeze	Percent	100	fixed	fixed
LOCKS / DISABLES				
Dispense Lockout	y/n	Yes		
Rinse Alarm	y/n	No		
Rinse Alarm Time	Hours	12	8	24
Rinse Lockout	y/n	No		
Low Hopper Lockout	y/n	No		
Puck Bin	y/n	Yes		
Puck Capacity	Shots	70	30	80
Energy Saver	y/n	No		
Set Password 1	xxxx	0000	0000	9999
Set Password 2	xxxx	0000	0000	9999

OPERATING CONTROLS AND INTERFACE

ACCESSING AND MODIFYING MACHINE SETTINGS

The following will guide you through each top-level setting found in programming.

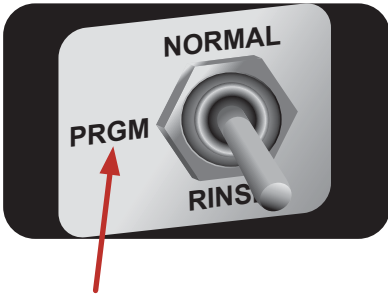

STEP 1

- Set the toggle switch to Program mode.

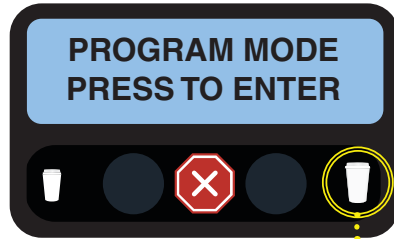

Use to Navigate

STEP 2

- Advance to the SM ESP GRIND TIME screen.

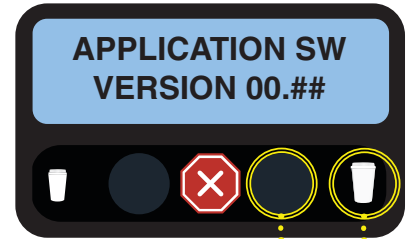

Use to view additional information.

Use to Navigate

STEP 3

- The screen will display the software version.
- Use the hidden switch to view app version, bootloader, PCAP, configuration, power setting and serial number.



Use to select

Use to Navigate

STEP 4

- Selecting YES will display statistics for the machine.
- Navigate to the next setting.



Use to Navigate

STEP 5

- Displays the current temperatures for the tanks.
- Navigate to the next setting.

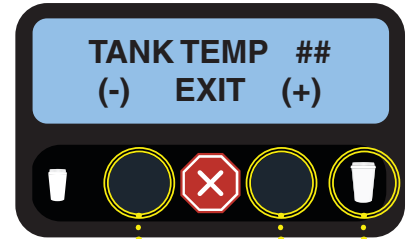

Use to decrease

Use to increase

Use to Navigate

STEP 6

- The heater control target temperature for the soluble tank.
- Navigate to the next setting.

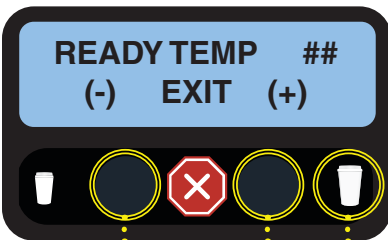

Use to decrease

Use to increase

Use to Navigate

STEP 7

- This is the minimum temperature required to dispense a beverage (soluble tank).
- Navigate to the next setting.



Use to decrease

Use to increase

Use to Navigate

STEP 8

- The heater control target temperature for the espresso tank.
- Navigate to the next setting.



Use to decrease

Use to increase

Use to Navigate

STEP 9

- This the minimum temperature required to dispense a beverage (espresso tank).
- Navigate to the next setting.

OPERATING CONTROLS AND INTERFACE

ACCESSING AND MODIFYING MACHINE SETTINGS (continued)

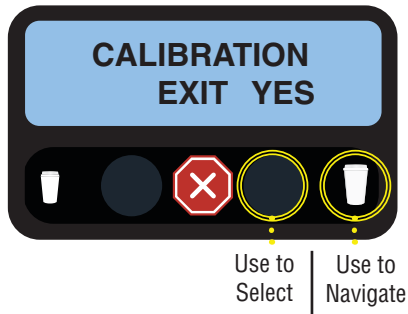

STEP 11

- Select to make machine calibrations.
- Navigate to the next setting.

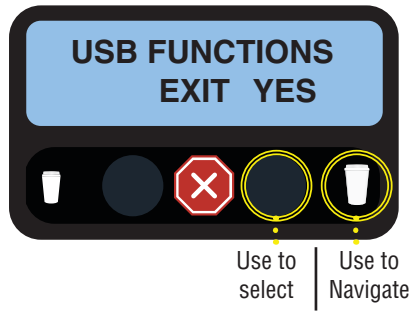

STEP 12

- Select to perform import/export of settings.
- Navigate to the next setting.



STEP 13

- Navigate to the next setting.

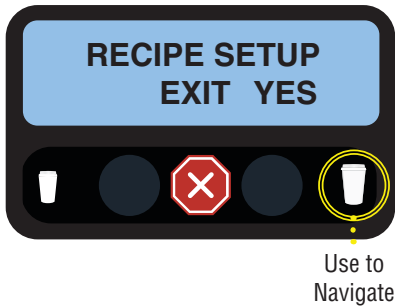

STEP 14

- Navigate to the next setting.

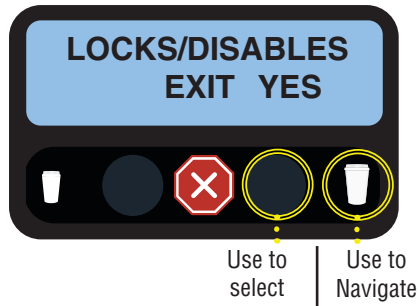

STEP 15

- Provides the ability to set lock-out modes or set alarms.
- Navigate to the next setting.

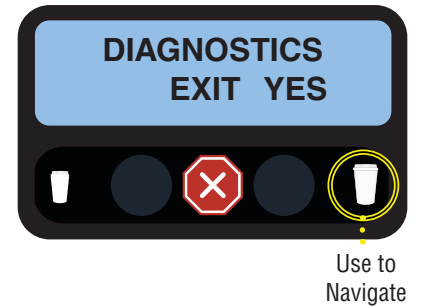

STEP 16

- Navigate to the next setting.

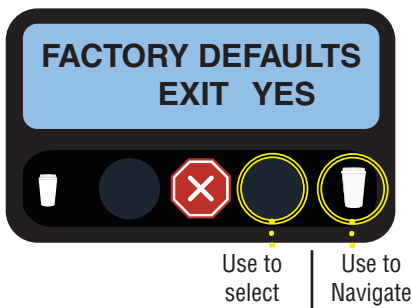

STEP 17

- Select this option to perform a factory reset.
- End of program settings.

OPERATING CONTROLS AND INTERFACE

CHANGE DISPLAY LANGUAGE

The display language can be changed in the PROGRAMMING MENU.

NOTE: Software version 00.46 has these languages available:

English, Spanish, French Canadian, French European, German, Portuguese, Simplified Chinese.

NOTE: Traditional Chinese, Japanese and Korean are available, but they require a special display module.

To access the “SELECT LANGUAGE” menu:



1. Open the door and place the NORMAL/PROGRAM/RINSE switch in the PROGRAM position.

2. Press buttons 1-5-9-10 in sequence. (Figure 2)



Figure 2



3. Use the (-) or (+) buttons to scroll through the available languages.

4. Press the  button to accept the new selection and exit to the programming menu.

ENERGY SAVER MODE

In this mode, the machine will operate in a low power mode during off hours to save energy. The display backlight will be turned off, and the display message will toggle between “Energy Saver/Mode Enabled” and “Change to Normal/Mode to Clear”. The dispense buttons are disabled so that no beverage dispensing is allowed. The tank refill and powder (soluble) tank heater are disabled. The espresso tank temperature setting is reduced to 130°F (54°C).

To enable the Energy Saver mode:

1. In PROGRAM mode, press the LARGE cup button (button “A”), to navigate to the “LOCKS/DISABLES” menu.
2. Press the button under “YES” (button “B”) and then the LARGE cup size, (button “A”), until the screen displays “ENERGY SAVER?”.
3. In the default menu, “NO” will be flashing. Press the button under “YES” to enable the Energy Saver mode.
4. When “YES” is flashing on the display, press the button under “EXIT” to return to the main screen.
5. Place the NORMAL/PROGRAM/RINSE switch to the NORMAL position.

To place the unit in the ENERGY SAVER mode, open the door, and place the NORMAL/PROGRAM/RINSE switch in the RINSE position. After ten minutes with the switch in the RINSE position, the ENERGY SAVER mode will become active. If a rinse cycle has taken place, and the switch is left in the RINSE position, the ENERGY SAVER mode will become active ten minutes after the rinse cycle was completed. To exit the ENERGY SAVER mode, return the NORMAL/PROGRAM/RINSE switch to the NORMAL position.

OPERATING CONTROLS AND INTERFACE

SOFTWARE SETUP FOR THROUGH COUNTER OPTION

1. Open the door and place the NORMAL/PROGRAM/RINSE switch in the PROGRAM position.
2. In the PROGRAM mode, use the LARGE cup, (button "A"), to navigate to the "LOCKS/DISABLES" menu.
3. Press the button under "YES" (button "B") and then the LARGE cup size, (button "A"), until the screen displays the "PUCK BIN" screen.
4. In the default menu, "YES" will be flashing. Press the button under "NO" to disable the PUCK BIN mode.
5. When "NO" is flashing on the display, press the button under "EXIT" to return to the main screen.
6. Place the NORMAL/PROGRAM/RINSE switch to the NORMAL position.

LOCKS / DISABLES

1. Open the door and place the NORMAL/PROGRAM/RINSE switch in the PROGRAM position.
2. Use the Large Cup button to scroll to the LOCKS/DISABLES screen, and press the button under "YES".
3. In the DISPENSE LOCKOUT screen, pressing the button under YES will prevent the dispenser from operation if the tanks are not at the minimum ready temperature requirement. Pressing the button under NO will allow dispensing if the tank temperatures are below ready temperature requirement.
4. Press the Large Cup button to RINSE ALARM. Pressing the button under YES will enable the rinse alarm. The screen will display RINSE ALARM TIME. Use the buttons under (-) and (+) to modify the rinse alarm time. If the time set since the last rinse has been exceeded, a rinse required will be displayed on the front door screen.
5. Press the Large Cup button to RINSE LOCKOUT. Pressing the button under YES will disable the dispenser once the RINSE ALARM TIME has expired. Running a rinse cycle will reset the timer, and enable the dispenser to resume normal operation.
6. Press the Large Cup button to LOW HPR LOCKOUT. Pressing the button under YES will prevent espresso shots from being prepared if the coffee bean hopper detects a low bean level condition. Filling the bean hopper above the low level will allow espresso brewing to resume.

OPERATING CONTROLS AND INTERFACE

DRAINING HOT WATER TANKS – To be performed by qualified service personnel only!

1. Open the door and place the NORMAL/PROGRAM/RINSE switch in the PROGRAM position. (Figure 1).
2. Close the door and place a minimum two liter container under the dispense nozzles.
3. Press the Large Cup button until the screen reads DIAGNOSTICS.
4. Press, in sequence, buttons 3, 7, 4 and 1. See Figure 2 for button number designations.
5. The screen will display SYSTEM WET TEST. Press the button under YES.
6. Press the button under COOL ESP TANK.
7. Press the button under START in the COOL ESP TANK screen.
8. The pump will begin running, and hot water will dispense into the container. After 4 minutes, the pump will automatically stop.
9. In the ESP TANK COOL? screen, press the button under YES.



Figure 1

NOTE: Dispenser must be disconnected from the power source in steps 10 through 24.

10. Immediately disconnect the dispenser from the power source, and water supply.
11. Let the water in the soluble tank cool before draining.
12. Remove left side panel.
13. Pull the drain tube out of the dispenser and direct it into a drain or a container large enough to hold the volume of water in the tank, approx 6 liter (1.5 gallon).
14. Remove the plug from end of tube.
15. After the tank has drained, replace the plug in the end of the tube.
16. Remove the tube from the connector in the bottom of the espresso tank.
17. Swivel the tube towards the outside of the machine.
18. Empty the container used to capture the hot water from the tank, and place it on the right side of the machine.
19. Insert a 6mm OD tube into the bottom tank fitting, place the other end into the container.
20. Use a 4mm hex wrench to loosen the plug on the top of the espresso tank, until the tank begins to drain.
21. After the tank is drained, retighten the plug.
22. Remove the drain tube from the bottom tank fitting.
23. Rotate the fitting towards the inside of the tank. Compressing the release sleeve on the fitting, fully insert the pump tube.
24. Replace the left and right side panels.



Figure 2

OPERATING CONTROLS AND INTERFACE

PASSWORD PROTECTION

In the PROGRAMMING MENU, there are two levels of password protection available:

PASSWORD 1 Protects all program menu settings.

PASSWORD 2 Allows monitoring and changes to the tank temperature and strength adjust settings, but protects all other settings.

PASSWORD 1

1. To enter PASSWORD 1: Open the door and place the NORMAL/PROGRAM/RINSE switch in the PROGRAM position.
2. In the PROGRAMMING MENU the ENTER PASSWORD 1 screen will display after the APPLICATION/SW VERSION 00.## screen (refer to PROGRAM MENU flow chart).
3. The unit is shipped from the factory with a default password setting of 0000.
4. To set PASSWORD 1: The SET PASSWORD 1 screen will display near the end of the LOCKS/DISABLES menu. Use the (-) and (+) buttons to set any numerical password desired, from 0000 to 9999. Password is set one digit at a time.

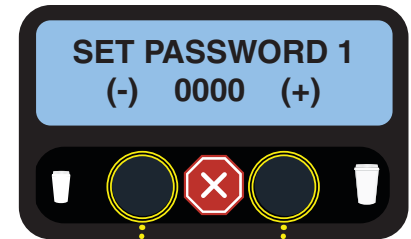

Use to enter or set the password.

PASSWORD 2

1. To enter PASSWORD 2: Open the door and place the NORMAL/PROGRAM/RINSE switch in the PROGRAM position.
2. In the PROGRAMMING MENU the ENTER PASSWORD 2 screen will display after the STRENGTH ADJUST menu (refer to PROGRAM MENU flow chart).
3. The unit is shipped from the factory with a default password setting of 0000.
4. To set PASSWORD 2: The SET PASSWORD 2 screen will display near the end of the LOCKS/DISABLES menu (refer to PROGRAM MENU flow chart). Use the (-) and (+) buttons to set any numerical password desired, from 0000 to 9999. Password is set one digit at a time.

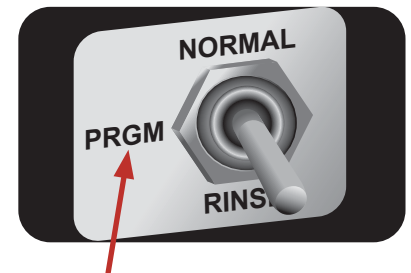

Use to enter or set the password.

OPERATING CONTROLS AND INTERFACE

Importing & Exporting Recipes

The option to import and export recipes is possible via USB drive. When importing recipes, ensure the USB drive is loaded with the correct file structure for the import to complete successfully. Performing an export for a recipe will provide the correct folder structure.

Recipes can be exported from one machine and imported into another. This ensures consistent recipe parameters and is convenient when setting up multiple machines.



STEP 1

- Open front door and verify if USB port is located under the Normal/ Prgm/ Rinse switch.
- If not present, proceed to Step 2.
- If present, proceed to Step 4.

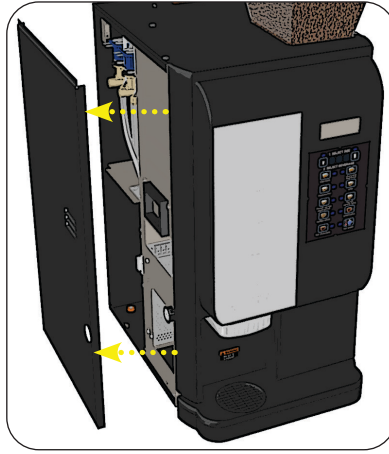

STEP 2

- Power off and unplug the machine.
- Loosen the hex screws at the bottom of the left panel.
- Remove the panel.

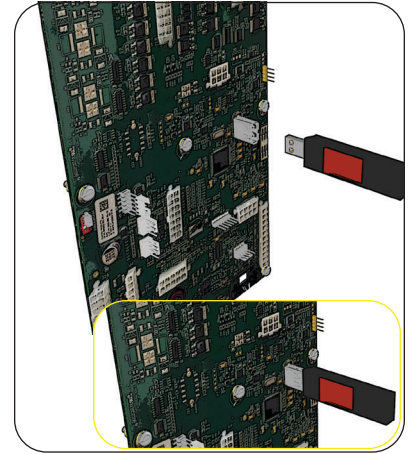

STEP 3

- Locate the USB port on the control board.
- Insert the USB device into the port.

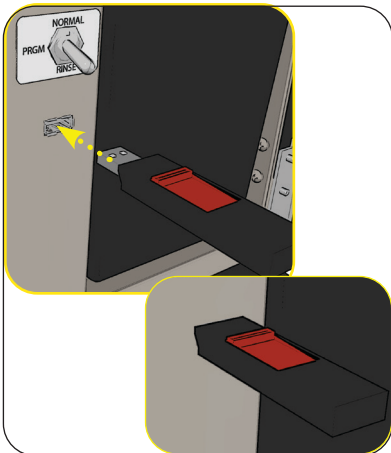

STEP 4

- Locate the USB port under the Normal/Prgm/Rinse switch.
- Insert the USB device into the port.

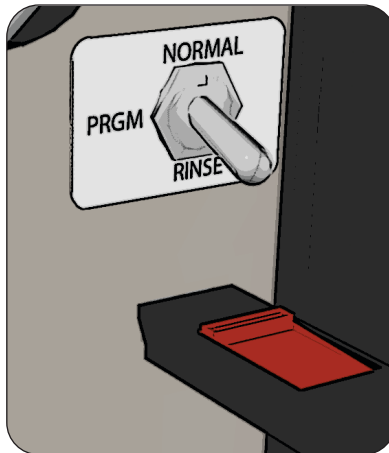

STEP 5

- Set the Normal/Prgm/Rinse switch to PGRM.
- Plug in and power on the machine.

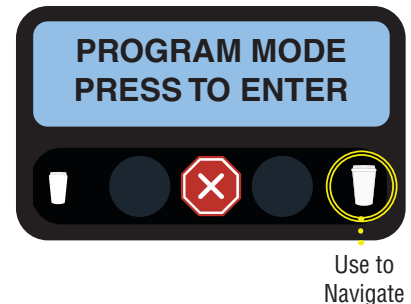

Use to Navigate

STEP 6

- Use the Large Cup switch to navigate to USB FUNCTIONS screen.

OPERATING CONTROLS AND INTERFACE

Importing & Exporting Recipes (continued)

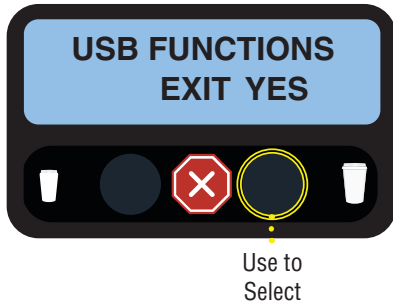

STEP 7

- At the USB FUNCTIONS screen, press the right switch.



STEP 8

- At the SELECT ACTION screen, press the left switch to import or the right switch to export recipes.
- Press the large cup key to navigate to the IMPORT RECIPES screen (or EXPORT RECIPES if in that mode).

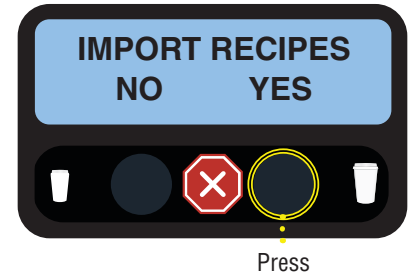

STEP 9

- Press the right switch to import all recipes.

NOTE: If exporting, the screen will read EXPORT RECIPES.



STEP 10

- Allow time for the import to complete.

NOTE: If exporting, the screen will read “exporting, please wait”.



STEP 11

- When complete, power off the machine and remove the USB device.
- Turn the Normal/Pgrm/Rinse switch to the Normal Position.

OPERATING CONTROLS AND INTERFACE

Importing & Exporting Machine Settings

The option to import and export settings is possible via USB drive. When importing settings, ensure the USB drive is loaded with the correct file structure for the import to complete successfully. Performing an export for a recipe will provide the correct folder structure.

Settings and recipes can be exported from one machine and imported into another. This ensures consistent values and parameter for setting up multiple machines.

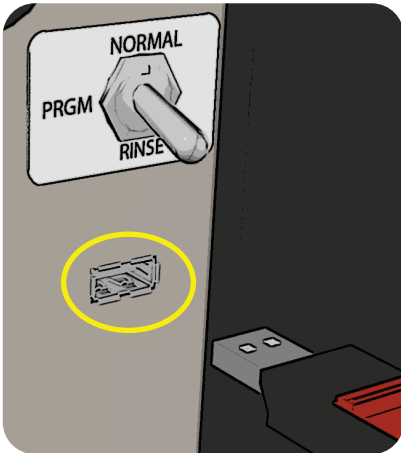

STEP 1

- Open front door and verify if USB port is located under the Normal/Prgm/Rinse switch.
- If not present, proceed to Step 2.
- If present, proceed to Step 4.

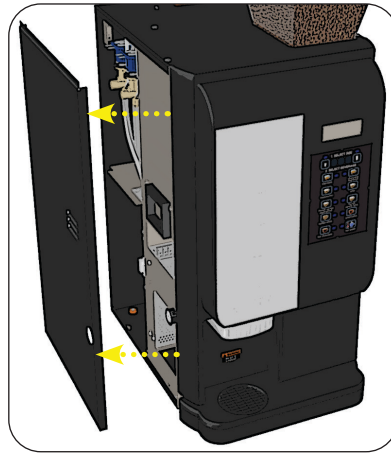

STEP 2

- Power off and unplug the machine.
- Loosen the hex screws at the bottom of the left panel.
- Remove the panel.

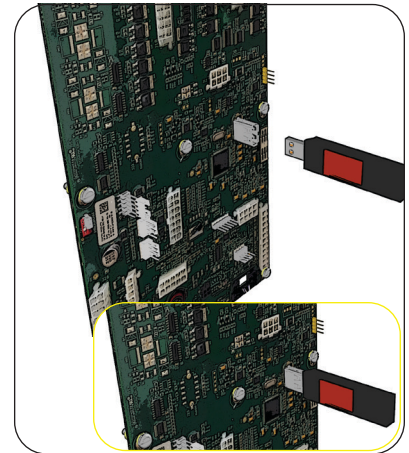

STEP 3

- Locate the USB port on the control board.
- Insert the USB device into the port.

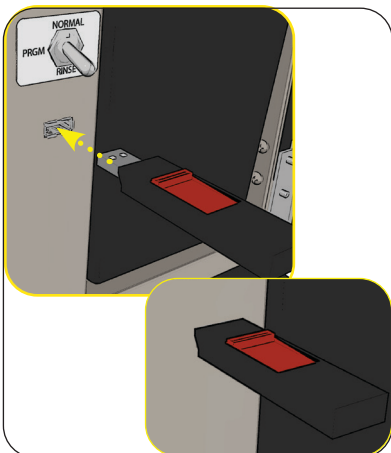

STEP 4

- Locate the USB port under the Normal/Prgm/Rinse switch.
- Insert the USB device into the port.



STEP 5

- Set the Normal/Prgm/Rinse switch to PGRM.
- Plug in and power on the machine.

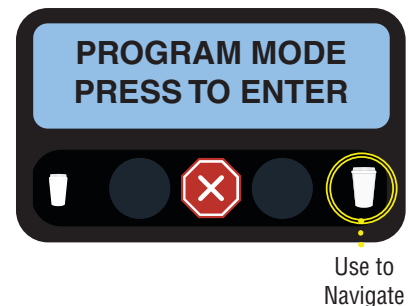

STEP 6

- Use the Large Cup switch to navigate to “USB Functions” screen.

OPERATING CONTROLS AND INTERFACE

Importing & Exporting Machine Settings (continued)

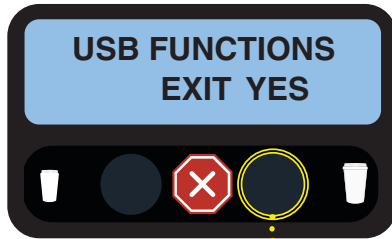

Use to
Select

STEP 7

- At the USB Functions screen, press the right switch.



Use to
Import Use to
Export

STEP 8

- At the Select Action screen, press the left switch to import or the right switch to export recipes.

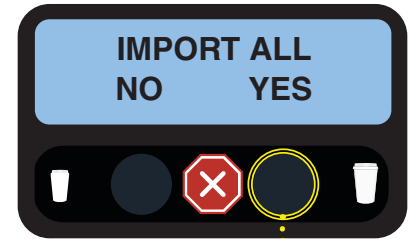

Press

STEP 9

- Press the right switch to import all recipes.

NOTE: If exporting, the screen will read “export all”.



STEP 10

- Allow time for the import to complete.

NOTE: If exporting, the screen will read “exporting, please wait”.



STEP 11

- When complete, power off the machine and remove the USB device.
- Turn the Normal/Pgrm/Rinse switch to the Normal Position.

OPERATING CONTROLS AND INTERFACE

Updating Software

When updating software, ensure the USB drive is loaded with the correct file structure for the update to complete successfully.



STEP 1

- Open front door and verify if USB port is located under the Normal/Prgm/Rinse switch.
- If not present, proceed to Step 2.
- If present, proceed to Step 4.

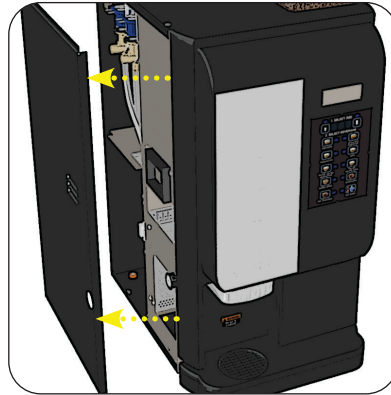

STEP 2

- Power off and unplug the machine.
- Loosen the hex screws at the bottom of the left panel.
- Remove the panel.

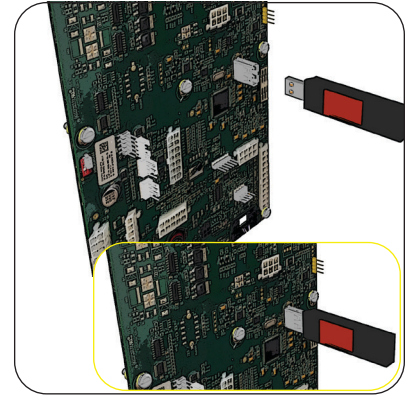

STEP 3

- Locate the USB port on the control board.
- Insert the USB device into the port.

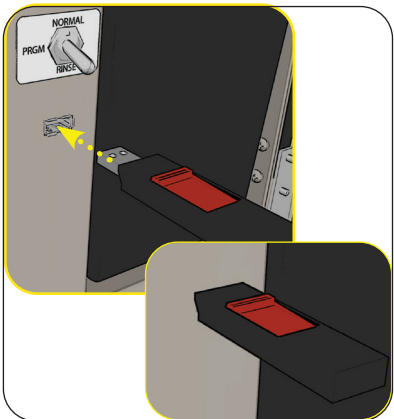

STEP 4

- Locate the USB port under the Normal/Prgm/Rinse switch.
- Insert USB device into the port.

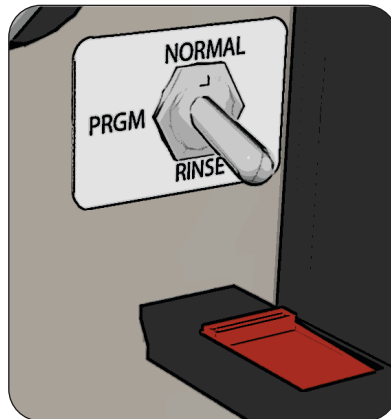

STEP 5

- Plug in and power on machine.



STEP 6

- Wait until the display shows the current application software version here.



STEP 7

- Wait another 5 - 10 seconds.

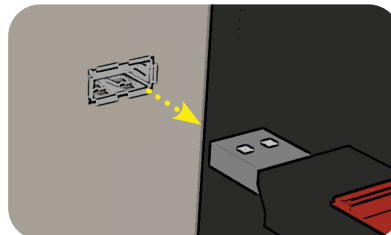

STEP 8

- Turn power off and remove the USB stick from the machine.

OPERATING CONTROLS AND INTERFACE

Changing The Switch Graphics - to be performed by qualified service personnel only!

The following instructions will guide you through the steps for installing the switch graphics.

Tools Required:

- Phillips Screwdriver

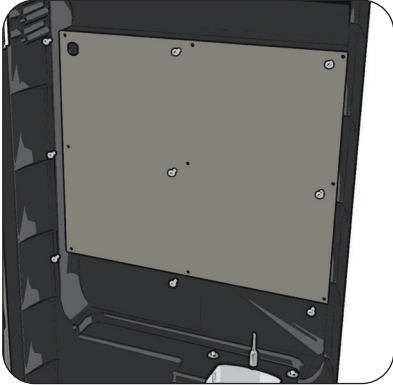

STEP 1

- Power off the machine and unplug.
- Open the front door.
- Remove the 9 screws that secure the panel to the back of the door.

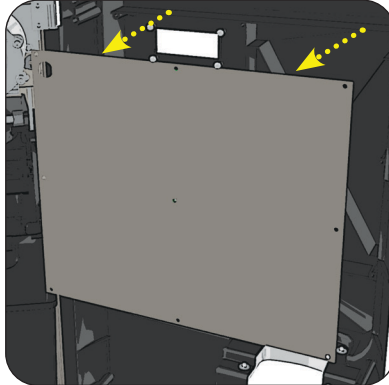

STEP 2

- Remove the panel from the door.

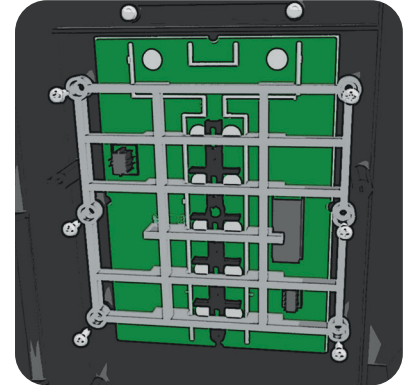

STEP 3

- Remove the screws that secure the holding bracket to door.

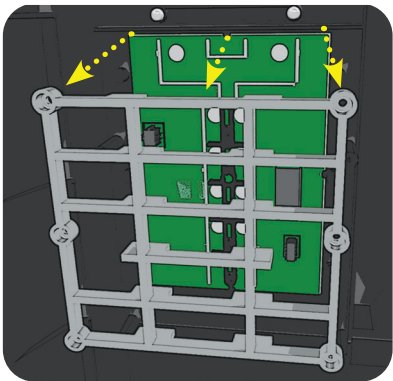

STEP 4

- Remove the holding bracket.

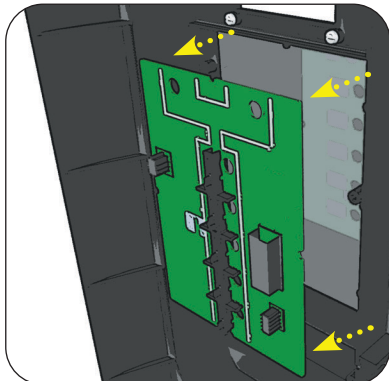

STEP 5

- Carefully remove the control board from the door assembly.

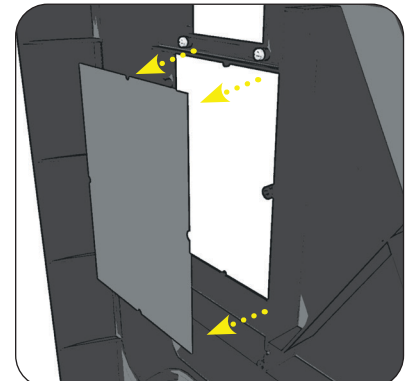

STEP 6

- Remove the switch graphics from the door.
- Replace with new switch graphics.
- Place the control board back in the door assembly.
- Reassemble the holding bracket and panel to the door.

PROGRAMMING FLOW CHART

CRESCENDO BUILD A BEVERAGE – Standard Beverage Selection

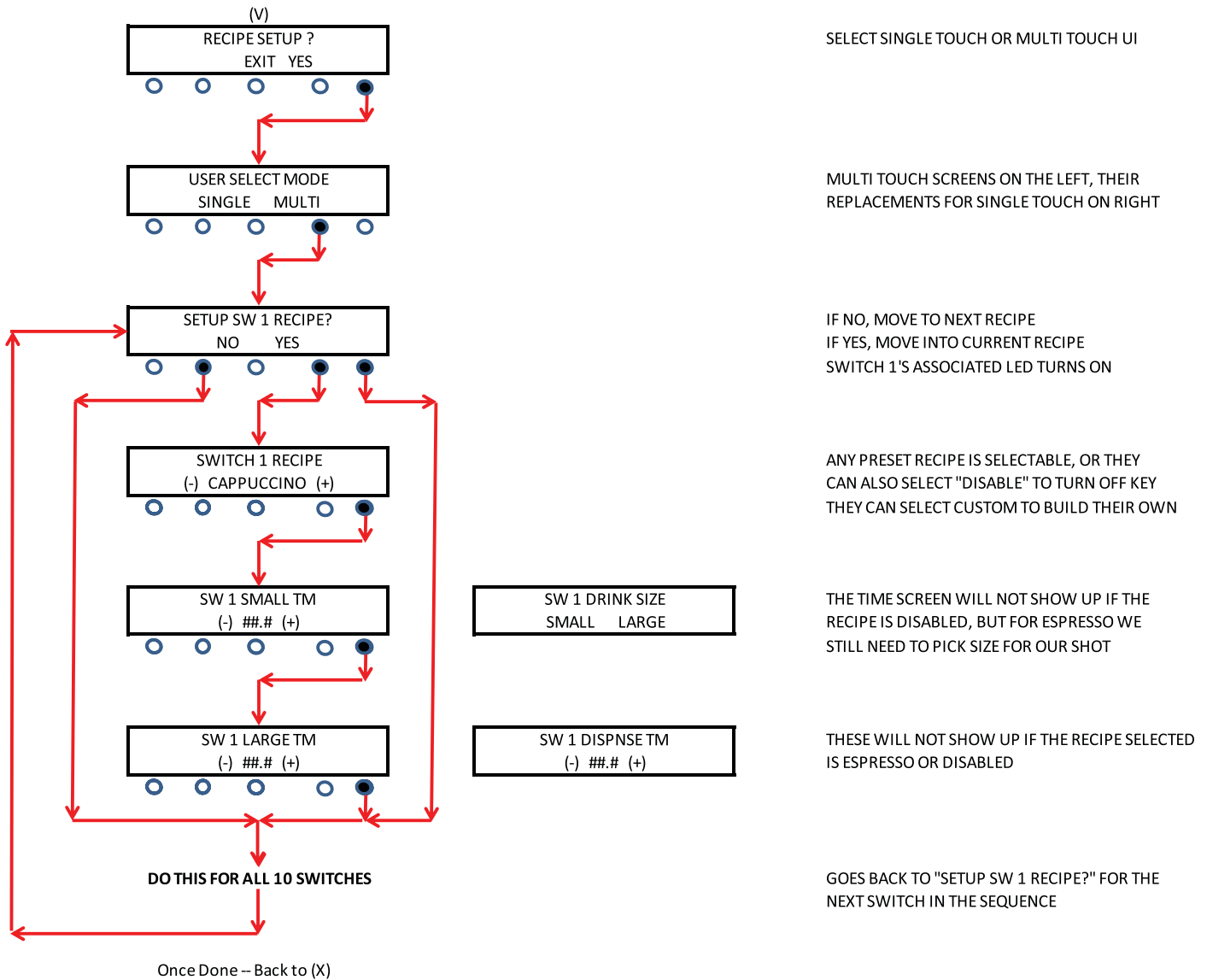

AS OF VERSION 00.42, THIS SHORTER TYPE OF SETUP WILL ONLY APPEAR FOR THE OPTIONS "DISABLED" OR "ESPRESSO".
FOR SINGLE TOUCH MODE YOU WILL SET A SIZE FOR ESPRESSO, BUT THERE ARE NEVER ANY TIME SCREENS AVAILABLE.

PROGRAMMING FLOW CHART

CRESCENDO BUILD A BEVERAGE – Custom Beverage Selection

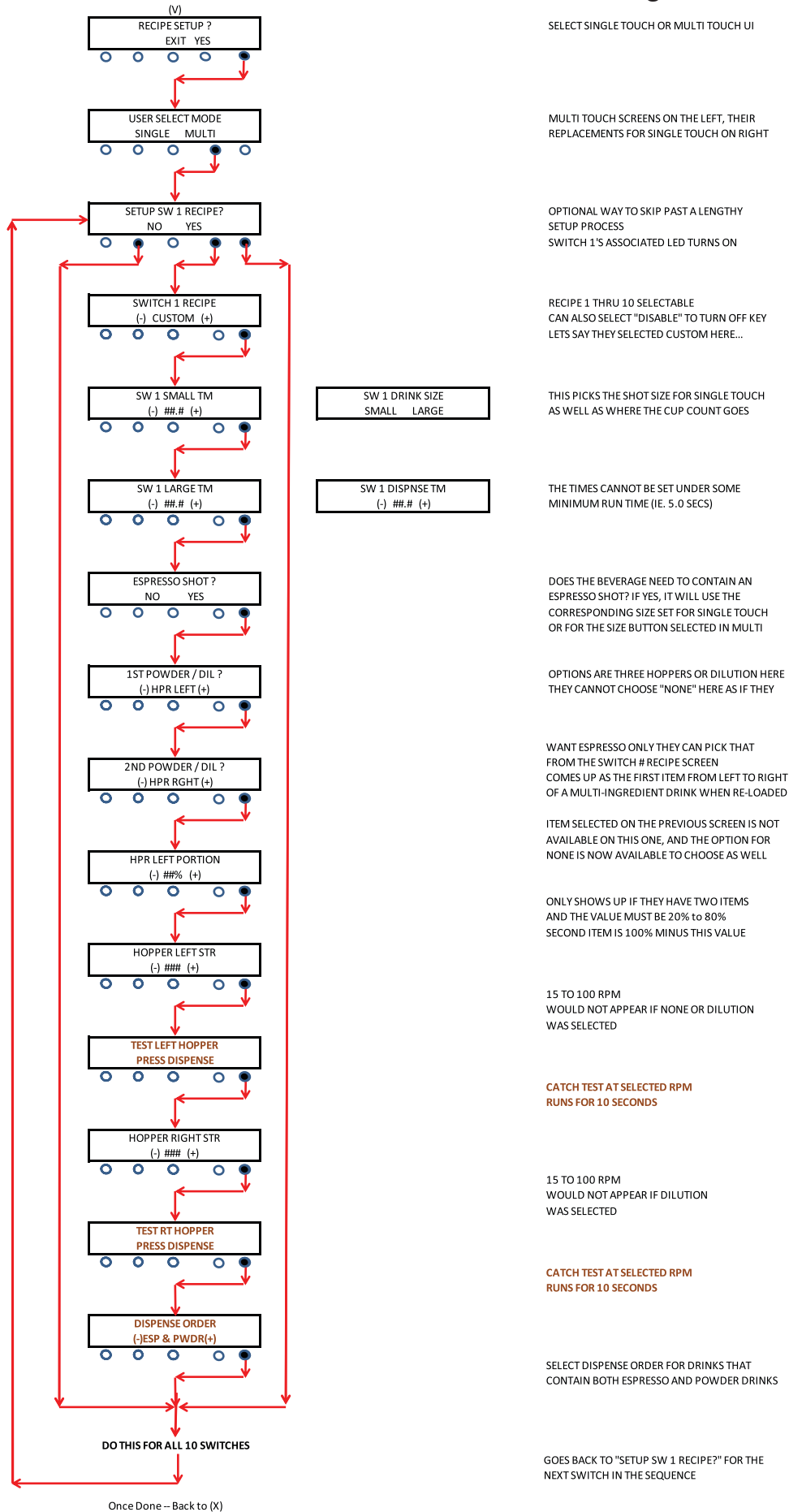

PROGRAMMING FLOW CHART

USB IMPORT / EXPORT - Screen Menu Flow

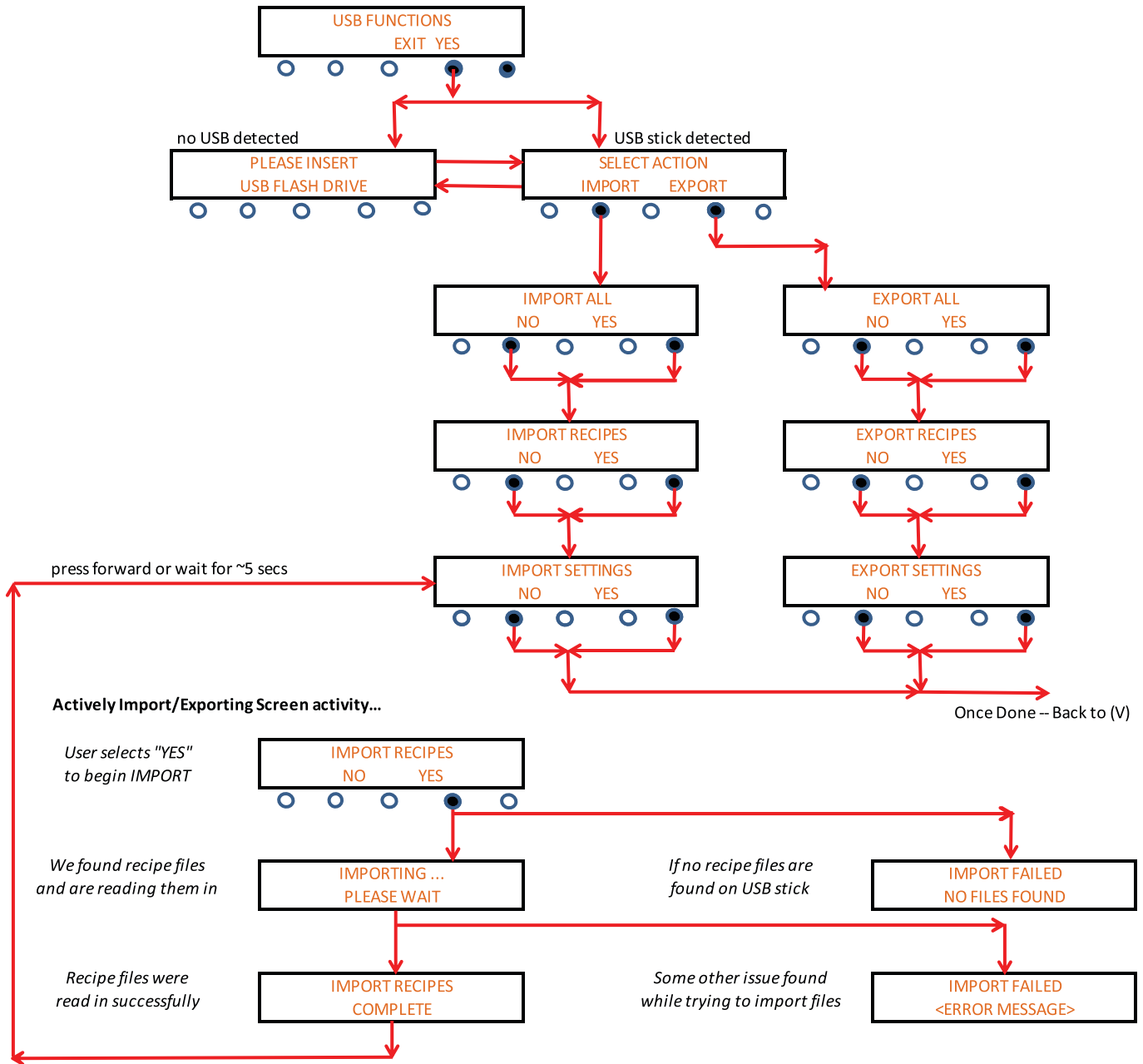

RINSE/CLEAN MODE FLOW CHART

Putting the RINSE/RUN/PROGRAM Switch to RINSE position will enable this menu set

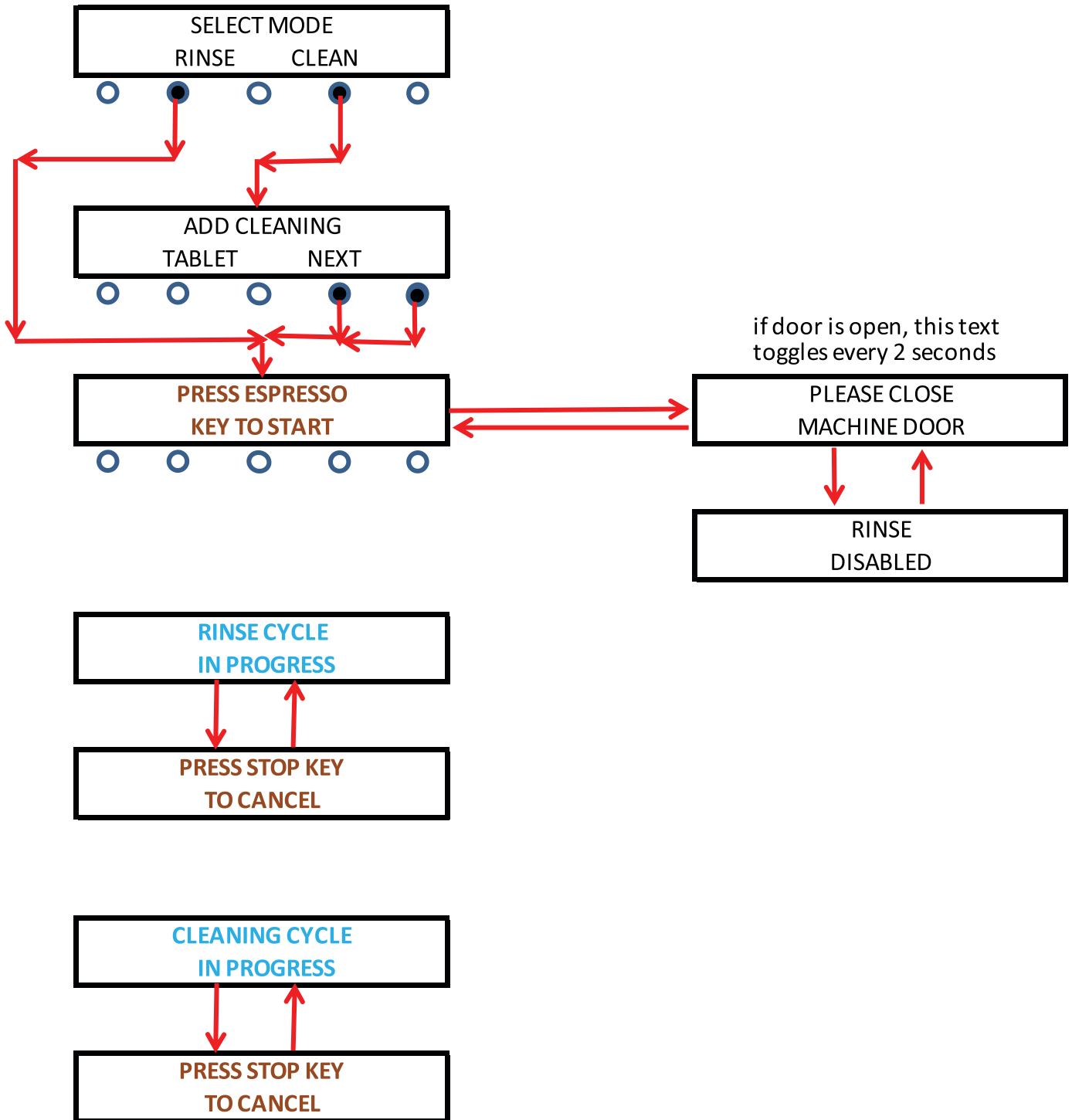

MENU GLOSSARY

TANK TEMP ### (-) EXIT (+)	Set soluble tank temperature.
READY TEMP ### (-) EXIT (+)	Set soluble tank ready temperature Tank temp. must reach this to enable brewing if brew lockout is set.
ESPRESSO TEMP ### (-) EXIT (+)	Set espresso tank temperature.
ESPRESSO READY ### (-) EXIT (+)	Set espresso tank ready temperature Tank temp. must reach this to enable brewing if brew lockout is set.
CALIBRATION EXIT YES	Takes you to the CALIBRATION sub-menu.
SET ESPRESSO SHOTS EXIT YES	Takes you to the SET ESPRESSO SHOTS sub-menu to set up espresso shots.
LOCKS/DISABLES EXIT YES	Takes you to the LOCK/DISABLES sub-menu.
DIAGNOSTICS (-) EXIT (+)	Takes you to the DIAGNOSTICS menu to test components.
FACTORY DEFAULTS NO YES	Takes you to the FACTORY DEFAULTS sub-menu to enable restoring factory defaults.
LEFT HOPPER STR (-) ## (+)	Use +/- buttons to increase or decrease powder hopper speed This menu repeats for middle and right hopper.
TEST LEFT HOPPER PRESS DISPENSE	Pressing any dispense button will run hopper for 10 seconds, at speed set in menu above. This allows a catch test.
SM ESP GRIND TIME (-) ## sec (+)	Pressing any dispense button will run grinder for the small espresso programmed time. This allows a catch test. Menu repeats for large espresso grind time.
TEST SM GRIND DISPENSE TO TEST	Pressing any dispense button will run grinder for the small espresso programmed time. This allows a catch test. Menu repeats for large espresso grind time.
SELECT UNITS ENG EXIT METRIC	Allows applicable data be displayed in English or Metric units.

MENU GLOSSARY

<p>0 REFILL 155 (-) EXIT (+)</p>	<p>Sets threshold for refill probe on soluble water tank. Allow adjustment for different water conditions.</p>
<p>CAL HOT WATER PRESS DISPENSE</p>	<p>Pressing any dispense button opens the hot water valve for ten seconds. This allows the valve to be adjusted for the proper flow rate.</p>
<p>CAL LFT PWDR VLV PRESS DISPENSE</p>	<p>Pressing any dispense button opens the left hot water valve for ten seconds. This allows the valve to be adjusted for the proper flow rate.</p>
<p>CAL RT PWDR VLV PRESS DISPENSE</p>	<p>Pressing any dispense button opens the right hot water valve for ten seconds. This allows the valve to be adjusted for the proper flow rate.</p>
<p>#### BN HPR #### (-) EXIT (+)</p>	<p>This calibrates the photo sensor on the bean hopper by detecting the ambient light with the hopper empty, then setting a threshold for signaling the hopper is empty.</p>
<p>PRE-HEAT ESP GRP NO EXIT YES</p>	<p>This asks if you want to enable pre heating of the espresso group if espresso has not been brew within “X” amount of time. For espresso shots only, not for specialty drinks.</p>
<p>SET PRE-HEAT TIME (-) ###min (+)</p>	<p>Set amount of time in minutes, that if exceeded, will automatically go into pre-heat routine if an espresso shot is selected to be dispense.</p>
<p>SM ESP GRIND TIME (-) #.# sec (+)</p>	<p>Set grinder run time for small espresso. Repeat of menu in STRENGTH ADJUST sub menu. Menu repeats for large espresso.</p>
<p>SM PREINFUSION (-) #.# sec (+)</p>	<p>Set espresso pump run time for pre-infusion of tamped coffee. Zero seconds for no pre-infusion Menu repeats for large espresso.</p>
<p>SM DWELL TIME (-) #.# sec (+)</p>	<p>Sets dwell time in seconds between pre-infusion, and start of espresso pump for final brewing Menu repeats for large espresso.</p>
<p>SM BREW VOLUME (-) ### (+)</p>	<p>Sets brew volume for small espresso by flow count of flow meter menu repeats for large espresso.</p>
<p>DISPENSE LOCKOUT? NO EXIT YES</p>	<p>Enable locking out of beverage dispensing if either tank is not at or above ready temperature.</p>
<p>RINSE ALARM? NO EXIT YES</p>	<p>Asks if you want to set an alarm if a rince cycle has not been run for “x” time since last rinse cycle.</p>
<p>RINSE ALARM TIME (-) 12hours (+)</p>	<p>Set the number of hours since last rinse cycle run before signalling a rinse in needed.</p>

MENU GLOSSARY

RINSE LOCKOUT? NO EXIT YES	Enable you to lock out dispensing of any beverage until a rinse cycle is completed.
LOW HPR LOCKOUT NO EXIT YES	Enables you to prevent brewing of espresso if low bean hopper condition detected.
TEST SWITCHES UseSwitchToTest	Pressing any switch on door will display switch number on LCD display to confirm function Momentary switch function.
TEST POWDER HTR EXIT YES	Pressing any switch on door will active soluble tank water heater Momentary switch function.
TEST ESPRSO HTR EXIT YES	Pressing any switch on door will active espresso tank water heater Momentary switch function.
TEST REFILL EXIT YES	Pressing any switch on door will active soluble tank refill valve Momentary switch function.
TEST LEFT AUGER DISPENSE TO TEST	Pressing any switch on door will active left hopper auger motor Momentary switch function.
TEST MDL AUGER DISPENSE TO TEST	Pressing any switch on door will active middle hopper auger motor Momentary switch function.
TEST RIGHT AUGR DISPENSE TO TEST	Pressing any switch on door will active right hopper auger motor Momentary switch function.
TEST LEFT WHIPR DISPENSE TO TEST	Pressing any switch on door will left whipper motor Momentary switch function.
TEST RT WHIPPER DISPENSE TO TEST	Pressing any switch on door will right whipper motor Momentary switch function.
TEST HOT WATER DISPENSE TO TEST	Pressing any switch on door will active hot water valve Momentary switch function.
TEST LFT PWDR VLV DISPENSE TO TEST	Pressing any switch on door will active left powder hot water valve Momentary switch function.
TEST RT PWDR VLV DISPENSE TO TEST	Pressing any switch on door will active left powder hot water valve Momentary switch function.

MENU GLOSSARY

TEST DRAIN VALVE
DISPENSE TO TEST

Pressing any switch on door will activate the drain valve in the brew group Momentary switch function.

TEST PUMP N VALV
DISPENSE TO TEST

Pressing any switch on door will activate solenoid pump and espresso valve Momentary switch function.

TEST ESPRESO VALV
DISPENSE TO TEST

Pressing any switch on door will activate the espresso valve Momentary switch function.

TEST SOLUBLE FAN
DISPENSE TO TEST

Pressing any switch on door will activate the soluble fan Momentary switch function.

PUCK BIN
NOT PRESENT

Signals puck bin status.

TEST GRINDER
DISPENSE TO TEST

Pressing any switch on door will activate coffee grinder motor Momentary switch function.

TEST FLOW METER
FLOW METER: 0

Pressing any switch on door will activate espresso pump and hot water valve. Flow counts will increment on LCD display. Momentary switch function.

TEST PISTON
DOWN 140 UP

Pressing button below "DOWN" or "UP" on LCD display will activate appropriate piston action.

TEST SIEVE
OPEN 0 CLOSE

Pressing button below "OPEN" or "CLOSE" on LCD display will activate appropriate sieve head action.

PUCK BIN
NO EXIT YES

Pressing button below "YES" will enable the puck bin counting functionality, whereas selecting "NO" sets up the machine for thru-counter operation.

PUCK CAPACITY
(-) ### (+)

Sets the amount of pucks the bin can hold before it needs to be emptied, and is only allowed to be set if the puck bin feature is currently enabled.

STATISTICS
EXIT YES

Takes you to the statistics sub-menu so that you can look at cup counts.

ODOMETER
#####

Total overall drinks dispensed by this machine in its lifetime, non-resettable.

SM LIFETM COUNTS
SELECT BEVERAGE

Drinks dispensed per beverage of the small cup counts size, press and release a dispense button to see the number of times that recipe has been dispensed.

MENU GLOSSARY

LG LIFETM COUNTS
SELECT BEVERAGE

Drinks dispensed per beverage of the large cup counts size, press and release a dispense button to see the number of times that recipe has been dispensed.

SM RESETABL CNTS
SELECT BEVERAGE

Same concept as the lifetime counters except these can be reset by the customer as desired. This is for the small recipe size.

LG RESETABL CNTS
SELECT BEVERAGE

Same concept as the lifetime counters except these can be reset by the customer as desired. This is for the large recipe size.

APPLICATION
SW VERSION ##.##

Screen to display the application and other software versions of the machine Can also display the bootloader version, PCAP module version, and LCD type.

ENTER PASSWORD 1
(-) 0000 (+)

Screen to enter the password (either Level 1 or Level 2) to get further into the program mode menus. Has an associated password "Set" screen as well.

ENERGY SAVER ?
NO EXIT YES

Screen to enable or disable the energy saver mode feature.

USB FUNCTIONS
EXIT YES

Screen to select USB functions for importing and exporting machine configuration.

SET ESPRESSO SHOTS
EXIT YES

Screen to select to configure the two espresso shot sizes on the machine.

RECIPE SETUP ?
EXIT YES

Screen to select to configure all of the ingredients that dispense when a given beverage key is pressed (or if it should be disabled).

SELECT ACTION
IMPORT EXPORT

Screen to select if you want to IMPORT settings and recipes from the USB Flash that is inserted, or if you want to EXPORT the configuration to the stick.

TOUCH SETTINGS
NO YES

Screen to enter the sub-menu to adjust the system touch settings.

TOUCHLESS MODE
DISPENSE TO TEST

Screen to select to configure the PCAP module's operation mode, either as "touch" (no), or as "touchless" (yes). The screen will say "NOT AVAILABLE!" if the PCAP is too old.

SENSITIVITY
NORMAL HIGH

Screen to select to configure the PCAP module's sensitivity level within whatever mode is currently selected, as either "normal" (instead of "low") or "high".

CONFIRM DISPENSE
NO YES

Screen to select to configure whether or not user selected dispenses in RUN mode require them to select the beverage key a second time as the LED flashes to dispense.