



INSTALLATION & OPERATING GUIDE

For Technical Service, contact Bunn-O-Matic Corporation at 1-800-286-6070.

Bunn-O-Matic Corporation
Post Office Box 3227, Springfield, Illinois 62708-3227
Phone (217) 529-6601 | Fax (217) 529-6644

BUNN-O-MATIC COMMERCIAL PRODUCT WARRANTY

Bunn-O-Matic Corp. ("BUNN") warrants the BUNN Crescendo as further described below for a warranty period of 1 year parts and labor.

These warranty periods run from the date of installation. BUNN warrants that the equipment manufactured by it will be commercially free of defects in material and workmanship existing at the time of manufacture and appearing within the applicable warranty period. This warranty does not apply to any equipment, component or part that was not manufactured by BUNN or that, in BUNN's judgment, has been affected by misuse, neglect, alteration, improper installation or operation, improper maintenance or repair, non periodic cleaning and descaling, equipment failures related to poor water quality, damage or casualty. This warranty is conditioned on the Buyer 1) giving BUNN prompt notice of any claim to be made under this warranty by telephone at (217) 529-6601 or by writing to Post Office Box 3227, Springfield, Illinois 62708-3227; 2) if requested by BUNN, shipping the defective equipment prepaid to an authorized BUNN service location; and 3) receiving prior authorization from BUNN that the defective equipment is under warranty. Additionally, the following is excluded from the warranty period:

Warranty Exclusions:

- Parts such as, but not limited to, hoppers and lids, drip trays, and plastic parts damaged due to improper handling or cleaning agents.
- Replacement of wear items such as, but not limited to, O-rings, gaskets, silicone tubes, hoses, and valve seats.
- Repairs made necessary due to poor water quality such as dispense valves, water inlet valves, scaling in the steam or hot water boilers. (Total Hardness recommended range of 4-7 gpg constant).
- Improper voltage. (See equipment operations manual for voltage specifications).
- Failure to use BUNN approved cleaning supplies constitutes improper maintenance.
- Failure to have required preventive maintenance performed by BUNN technician or authorized espresso service provider.
- Parts replaced under the terms of this warranty carry the remainder on the machine's parts warranty term, or 60 days, whichever is greater.
- Drink quality issues from machine failures related to product formulation or product characteristics.

THE FOREGOING WARRANTY IS EXCLUSIVE AND IS IN LIEU OF ANY OTHER WARRANTY, WRITTEN OR ORAL, EXPRESS OR IMPLIED, INCLUDING, BUT NOT LIMITED TO, ANY IMPLIED WARRANTY OF EITHER MERCHANTABILITY OR FITNESS FOR A PARTICULAR PURPOSE. The agents, dealers or employees of BUNN are not authorized to make modifications to this warranty or to make additional warranties that are binding on BUNN. Accordingly, statements by such individuals, whether oral or written, do not constitute warranties and should not be relied upon. If BUNN determines in its sole discretion that the equipment does not conform to the warranty, BUNN, at its exclusive option while the equipment is under warranty, shall either 1) provide at no charge replacement parts and/or labor (during the applicable parts and labor warranty periods specified above) to repair the defective components, provided that this repair is done by a BUNN Authorized Service Representative; or 2) shall replace the equipment or refund the purchase price for the equipment.

THE BUYER'S REMEDY AGAINST BUNN FOR THE BREACH OF ANY OBLIGATION ARISING OUT OF THE SALE OF THIS EQUIPMENT, WHETHER DERIVED FROM WARRANTY OR OTHERWISE, SHALL BE LIMITED, AT BUNN'S SOLE OPTION AS SPECIFIED HEREIN, TO REPAIR, REPLACEMENT OR REFUND. In no event shall BUNN be liable for any other damage or loss, including, but not limited to, lost profits, lost sales, loss of use of equipment, claims of Buyer's customers, cost of capital, cost of down time, cost of substitute equipment, facilities or services, or any other special, incidental or consequential damages.

392, A Partner You Can Count On, Air Infusion, AutoPOD, AXIOM, BrewLOGIC, BrewMETER, Brew Better Not Bitter, BrewWISE, BrewWIZARD, BUNN Espresso, BUNN Family Gourmet, BUNN Gourmet, BUNN Pour-O-Matic, BUNN, BUNN with the stylized red line, BUNNlink, Bunn-OMatic, Bunn-O-Matic, BUNNserve, BUNNSERVE with the stylized wrench design, Cool Froth, DBC, Dr. Brew stylized Dr. design, Dual, Easy Pour, EasyClear, EasyGard, FlavorGard, Gourmet Ice, Gourmet Juice, High Intensity, iMIX, Infusion Series, Intellisteam, My Café, Phase Brew, PowerLogic, Quality Beverage Equipment Worldwide, Respect Earth, Respect Earth with the stylized leaf and coffee cherry design, Safety-Fresh, vemycoffee.com, Scale-Pro, Silver Series, Single, Smart Funnel, Smart Hopper, SmartWAVE, Soft Heat, SplashGard, The Mark of Quality in Beverage Equipment Worldwide, ThermoFresh, Titan, trifecta, TRIFECTA (stylized logo), Velocity Brew, Air Brew, Beverage Bar Creator, Beverage Profit Calculator, Brew better, not bitter., Build-A-Drink, BUNNSource, Coffee At Its Best, Cyclonic Heating System, Daypart, Digital Brewer Control, Element, Milk Texturing Fusion, Nothing Brews Like a BUNN, Picture Prompted Cleaning, Pouring Profits, Signature Series, Sure Tamp, Tea At Its Best, The Horizontal Red Line, Ultra are either trademarks or registered trademarks of Bunn-O-Matic Corporation. The commercial trifecta® brewer housing configuration is a trademark of Bunn-O-Matic Corporation.

CONTENTS

WARRANTY	2
NORTH AMERICAN AND CE REQUIREMENTS	4
USER NOTICES.....	5
INITIAL SETUP	
Drip Tray, Brew Group and Bean Hopper.....	5
Filling Soluble Hoppers.....	6
Capacity.....	8
Electrical Requirements.....	8
Calibration	8
PLUMBING REQUIREMENTS	
Plumbing Hook-up	9
Initial Fill & Heat.....	9
Preset Tank Temperature	9
Liquid Level Control	9
OPERATING CONTROLS AND INTERFACE	
Operating The Dispenser.....	10
Modifying The Touch Switch Functions.....	11
Creating A “Custom” Beverage	11
Set Espresso Shots	11
Recipe Setup	12
Touchless Sensitivity Selection Options	14
Confirm Beverage Screens.....	15
DOOR SAFETY INTERLOCK	16
THROUGH COUNTER OPTION	
Countertop and Machine Modifications	16
Software Setup	16
ENERGY SAVER MODE.....	17
GENERAL CLEANING	18
CLEANING	
Daily.....	20
Weekly	
Rinse Cycle.....	21
Whipper Components	23
Hopper Components.....	24
BI-Weekly	
Brew Chamber	25
PREVENTIVE MAINTENANCE.....	28
ADJUSTMENTS	29
DRAINING THE HOT WATER TANKS	31
WIRING SCHEMATIC	32

TIP: For advanced programming information go to www.bunn.com to obtain the latest information.

NORTH AMERICAN REQUIREMENTS

- This appliance must be installed in locations where it can be overseen by trained personnel.
- For proper operation, this appliance must be installed where the temperature is between 41°F to 95°F (5°C to 35°C).
- Appliance shall not be tilted more than 10° for safe operation.
- An electrician must provide electrical service as specified in conformance with all local and national codes.
- This appliance must not be cleaned by pressure washer.
- This appliance can be used by persons if they have been given supervision or instruction concerning use of the appliance in a safe way and if they understand the hazards involved.
- Keep the appliance and its cord out of reach of children.
- Appliances can be used by persons with reduced physical, sensory or mental capabilities or lack of experience and knowledge if they have been given supervision or instruction concerning use of the appliance in a safe way and understand the hazards involved.
- If the power cord is ever damaged, it must be replaced by the manufacturer or authorized.
- Service personnel with a special cord available from the manufacturer or its authorized service personnel in order to avoid a hazard.
- Machine must not be immersed for cleaning.
- This appliance is intended for commercial use in applications such as:
 - staff kitchen areas in shops, offices and other working environments
 - by clients in hotel and motel lobbies and other similar types of environments
- Access to the service areas permitted by Authorized Service personnel only.

CE REQUIREMENTS

- This appliance must be installed in locations where it can be overseen by trained personnel.
- For proper operation, this appliance must be installed where the temperature is between 5°C to 35°C.
- Appliance shall not be tilted more than 10° for safe operation.
- An electrician must provide electrical service as specified in conformance with all local and national codes.
- This appliance must not be cleaned by water jet.
- This appliance is not intended for use by persons (including children) with reduced physical, sensory or mental capabilities, or lack of experience and knowledge, unless they have been given instructions concerning use of this appliance by a person responsible for its safety.
- Children should be supervised to ensure they do not play with the appliance.
- If the power cord is ever damaged, it must be replaced by the manufacturer or authorized service personnel with a special cord available from the manufacturer or its authorized service personnel in order to avoid a hazard.
- Machine must not be immersed for cleaning.
- Machine rated IX P1.

USER NOTICES

The notices on this dispenser should be kept in good condition. Replace unreadable or damaged labels.

⚠ WARNING

- ◆ Use only on a properly protected circuit capable of the rated load.
- ◆ Electrically ground the chassis.
- ◆ Follow national/local electrical codes.
- ◆ Do not use near combustibles.
- ◆ Do not deform plug or cord.

FAILURE TO COMPLY RISKS EQUIPMENT DAMAGE, FIRE OR SHOCK HAZARD.

READ THE ENTIRE OPERATING MANUAL BEFORE USING THIS PRODUCT

00986.0000M 10/14 ©1994 Bunn-O-Matic Corporation

00986.0000



00824.0002

⚠ WARNING

HOT LIQUID

12368.0002

As directed in the International Plumbing Code of the International Code Council and the Food Code Manual of the Food and Drug Administration (FDA), this equipment must be installed with adequate backflow prevention to comply with federal, state and local codes. For models installed outside the U.S.A., you must comply with the applicable Plumbing /Sanitation Code for your area.

00656.0001

⚠ WARNING

To reduce the risk of electric shock, do not remove or open cover. No user-serviceable parts inside. Authorized service personnel only. Disconnect power before servicing.

37881.0000

INITIAL SETUP

DRIP TRAY, BREW GROUP AND BEAN HOPPER

1. Remove drip tray and cover from the parts box. Attach the cover to the drip tray, then slide under the front door of the machine, engaging the rear of the drip tray into the opening in the lower front of the machine.
2. Remove keys from the door front.
3. Remove the espresso brew group from the parts box.
4. Place groove on lower front of brew chamber onto mounting bar on espresso drive.
5. Rotate the top of group head toward rear of machine until it snaps into place.

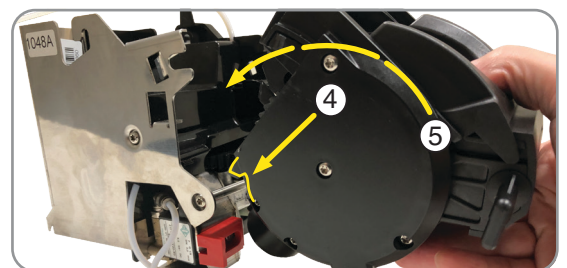

INITIAL SETUP

DRIP TRAY, BREW GROUP AND BEAN HOPPER (continued)

6. Connect brew chamber outlet tube.
7. Slide red lock to right until it locks.
8. Connect water inlet tube.
9. Remove the bean hopper from the parts box and install in top of machine.
10. Align the bean hopper so that the collar on the bottom of the bean hopper will engage the opening in the grinder.
11. When the hopper is in place on the grinder, pull the hopper gate all the way forward to allow beans into the grinder, then lock hopper in place.

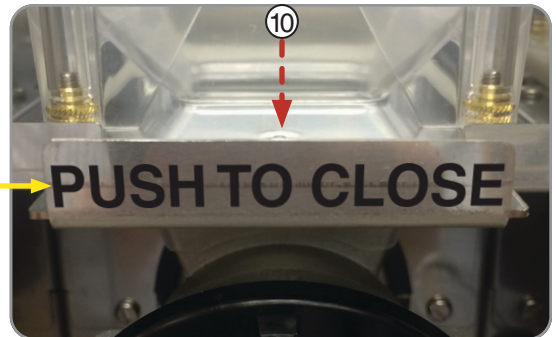
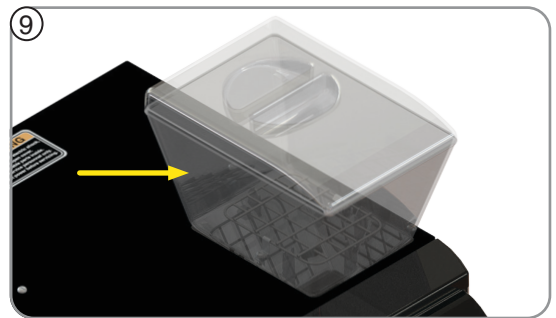
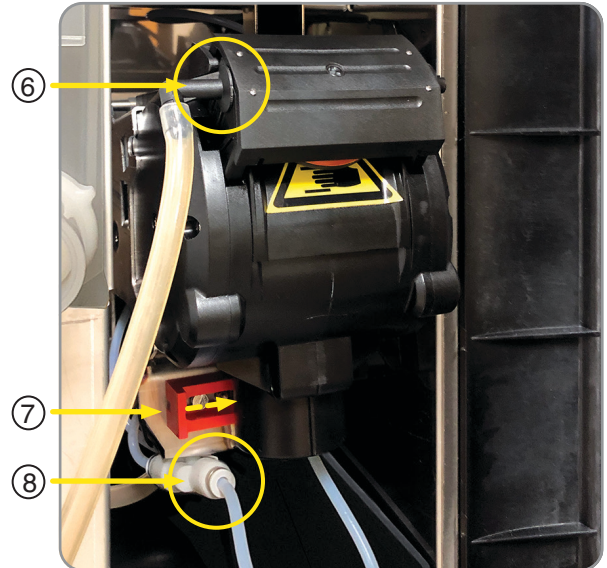

FILLING SOLUBLE HOPPERS

1. Remove packing material from on top of the powder hoppers.
2. Remove powder hoppers by lifting the front of the powder hopper until the peg on the bottom of the hopper clears the hole in the mounting plate.

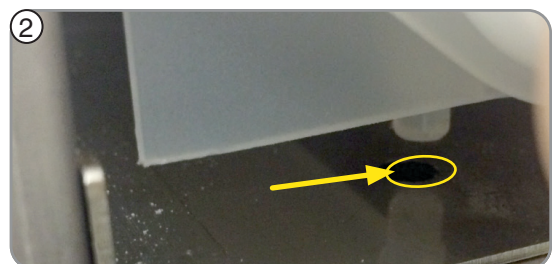

INITIAL SETUP

FILLING SOLUBLE HOPPERS (continued)

3. Pull the hopper forward to remove.
4. Set the hoppers on the counter, and push the slide gates on the elbows in to close.
5. Remove hopper lids.
6. Fill hoppers with appropriate soluble products.
NOTE: Default menu is milk product left hopper, chocolate is center hopper, and vanilla is right hopper.
7. Replace hopper lids.
8. Reinstall hoppers into machine.
NOTE: Make sure peg on bottom of hopper drops into locating hole on hopper platform.
9. After hoppers are installed, pull slider gates out so that powder can pass through to dispense.
10. Once everything is installed, Place the NORMAL/ PROGRAM/RINSE switch in the NORMAL position.
11. Close door.

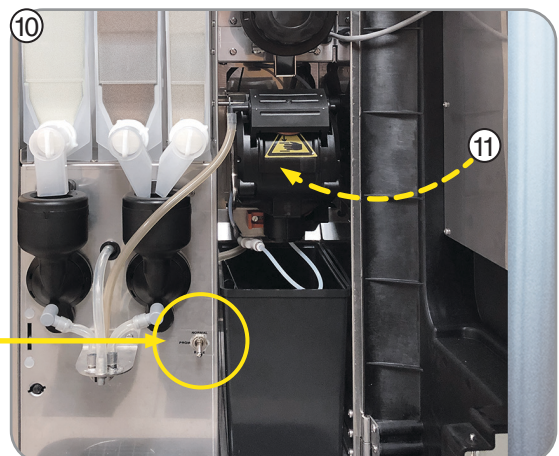
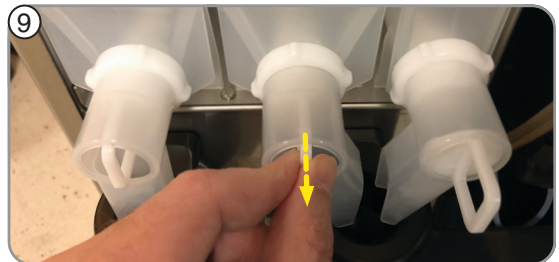
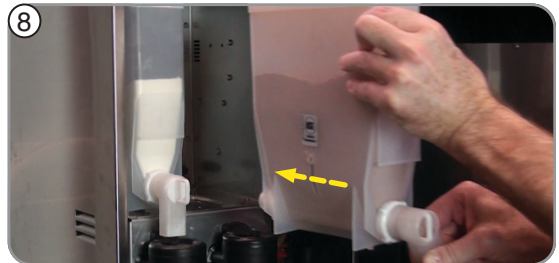
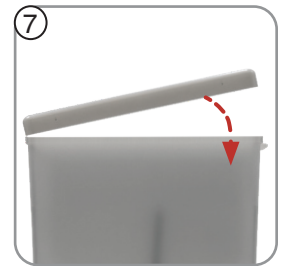
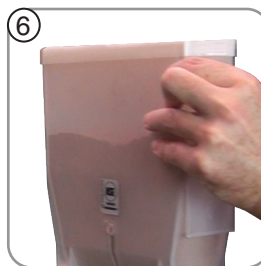
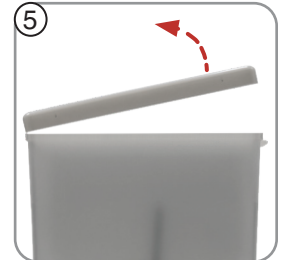
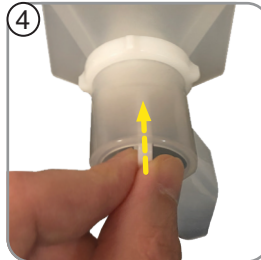

INITIAL SETUP

CAPACITY

1. Brew chamber has a capacity rating of 5 gm minimum up to 15 gm maximum of espresso grind coffee.
2. Brewer has a peak capacity of 60 single (small) espresso shots per hour.

ELECTRICAL REQUIREMENTS

CAUTION: The dispenser must be disconnected from the power source until specified in Electrical Hook-Up.

Electrical Hook-Up

CAUTION: Improper electrical installation will damage electronic components.

1. An electrician must provide electrical service as specified.
2. Using a voltmeter, check the voltage and color coding of each conductor at the electrical source.
3. Connect the dispenser to the power source.
4. If plumbing is to be hooked up later be sure the dispenser is disconnected from the power source. If plumbing has been hooked up, the dispenser is ready for Initial Fill & Heat.

Configuration

120V Configuration:

This electrical service consists of 2 current carrying conductors (L1 and Neutral) and a separate conductor for chassis ground.

120-208/240V Configuration:

This electrical service consists of 3 current carrying conductors (L1, L2 and Neutral) and a separate conductor for chassis ground.

220-240V Configuration:

This electrical service consists of 2 current carrying conductors (L1, L2) and a separate conductor for chassis ground.

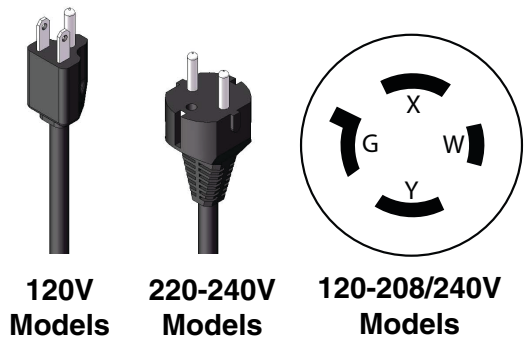

CALIBRATION PROCEDURE

NOTE: this is only recommended when a valve is replaced, or when water dispense volume is not met.

Begin by using an allen wrench to back out the flow-rate adjuster (counter-clockwise). The number of turns are shown next to each valve.

1. Open the door and place the toggle switch to the “PRGM” setting.
2. Use the large cup size icon to navigate to the menu to perform a timed dispense to determine flow-rate for valve(s) being replaced.
3. Use 6mm allen wrench to increase (counter-clockwise) or decrease (clockwise) flow-rate.

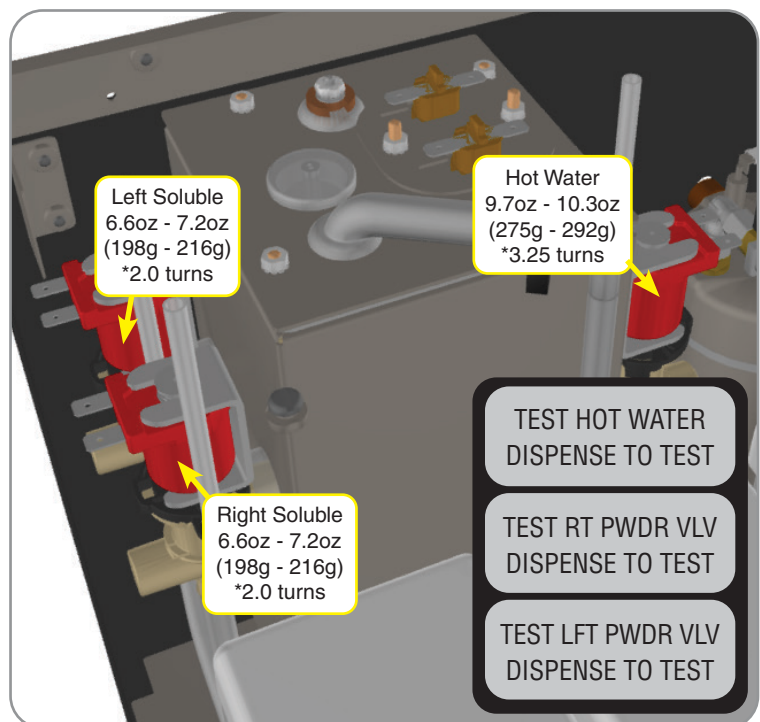

PLUMBING REQUIREMENTS

This dispenser must be connected to a cold water system with operating pressure between 138 - .620 MPa (20 and 90 psi) from a 1/2" or larger supply line. A shut-off valve should be installed in the line before the dispenser. Install a regulator in the line when pressure is greater than .620 MPa (90 psi) to reduce it to .345 MPa (50 psi). The water inlet fitting is 3/4" NPT (US and Canada Models) and 3/4 British Parallel Pipe for all other models.

NOTE: Bunn-O-Matic recommends 6mm copper tubing for installations of less than 25 feet and 8mm for more than 25 feet from the water supply line. At least 18 inches of an FDA approved flexible beverage tubing, such as reinforced braided polyethylene or silicone, before the dispenser will facilitate movement to clean the counter top. Bunn-O-Matic does not recommend the use of a saddle valve to install the dispenser. The size and shape of the hole made in the supply line by this type of device may restrict water flow.

As directed in the International Plumbing Code of the International Code Council and the Food Code Manual of the Food and Drug Administration (FDA), this equipment must be installed with adequate backflow prevention to comply with federal, state and local codes. For models installed outside the U.S.A., you must comply with the applicable Plumbing /Sanitation Code for your area.

NOTE: If a backflow preventer is required by code, a shock arrestor should be installed between backflow preventer and dispenser. Installing the shock arrestor as close to the dispenser as possible will provide the best results.

NOTE: Water pipe connections and fixtures directly connected to a potable water supply shall be sized, installed and maintained in accordance with federal, state and local codes.

PLUMBING HOOK-UP

NOTE: The plumbing connection is located on the back of the unit, using the water line included with some models, that connects to a 3/8" male flare or 3/4" hose thread.

1. Flush the water line and securely attach it to the valve threads on the rear of the dispenser.
2. Turn on the water supply.



INITIAL FILL & HEAT

1. Turn on the water supply, connect power to the dispenser, and place the main power switch on the rear of the machine to the ON position.
2. Water will automatically flow into the soluble tank to the proper level, then shut off. This will take less than five minutes. In the event that a message appears "fill time too long" power cycle to clear the message.
3. The screen on the front door will display FILL ESPRSO TANK. Press the button under START.
4. The screen will display MOVING BREW CHAMBER, ESP TANK FILLING, and the espresso tank will begin filling. This may take several minutes. In the event that a message appears "fill time too long", flip the toggle switch to program mode, then back to normal position to clear the message.
5. When water dispenses from the espresso nozzle into the drip tray, press YES under WATER DISPENSED? to stop the tank filling.
6. The tanks will then begin heating. When the tanks have completed heating, the display will read "READY TO BREW SELECT SIZE".

PRESET TANK TEMPERATURE

The tank temperatures have been preset at the factory to 80°C (180°F) for the soluble tank, and 102°C (215°F) for the espresso tank. Bunn recommends that to provide the best quality beverage, the installer adjust the tank temperature to the powder product manufacturers recommended temperature for the hot powder product being used.

1. Fill the hopper(s) with the dry product to be dispensed.
2. Fill the bean hopper with the whole beans to be ground and brewed. A grinder calibration should be performed.

LIQUID LEVEL CONTROL

The system automatically maintains the soluble hot water tank's level by energizing the refill solenoid when the water level drops below the liquid level probe. If the system has not successfully refilled, a refill error occurs. When a refill error occurs, the refill solenoid is de-energized. Once the cause of the refill error has been investigated and cured, the system can be reset by either cycling the power to the machine (at least five seconds) using the main power switch at the rear of the machine, or by entering one of the program modes (see Programming Modes.)

OPERATING CONTROLS AND INTERFACE

1. **Cup Size Buttons:** Momentarily pushed to select beverage size to dispense.
2. **Dispense Buttons:** Momentarily pushed to dispense selected beverage.
3. **LED indicators:** Illuminates when the adjoining button has been selected.
4. **Stop button:** Pressing the stop button during dispensing will stop the dispense sequence.

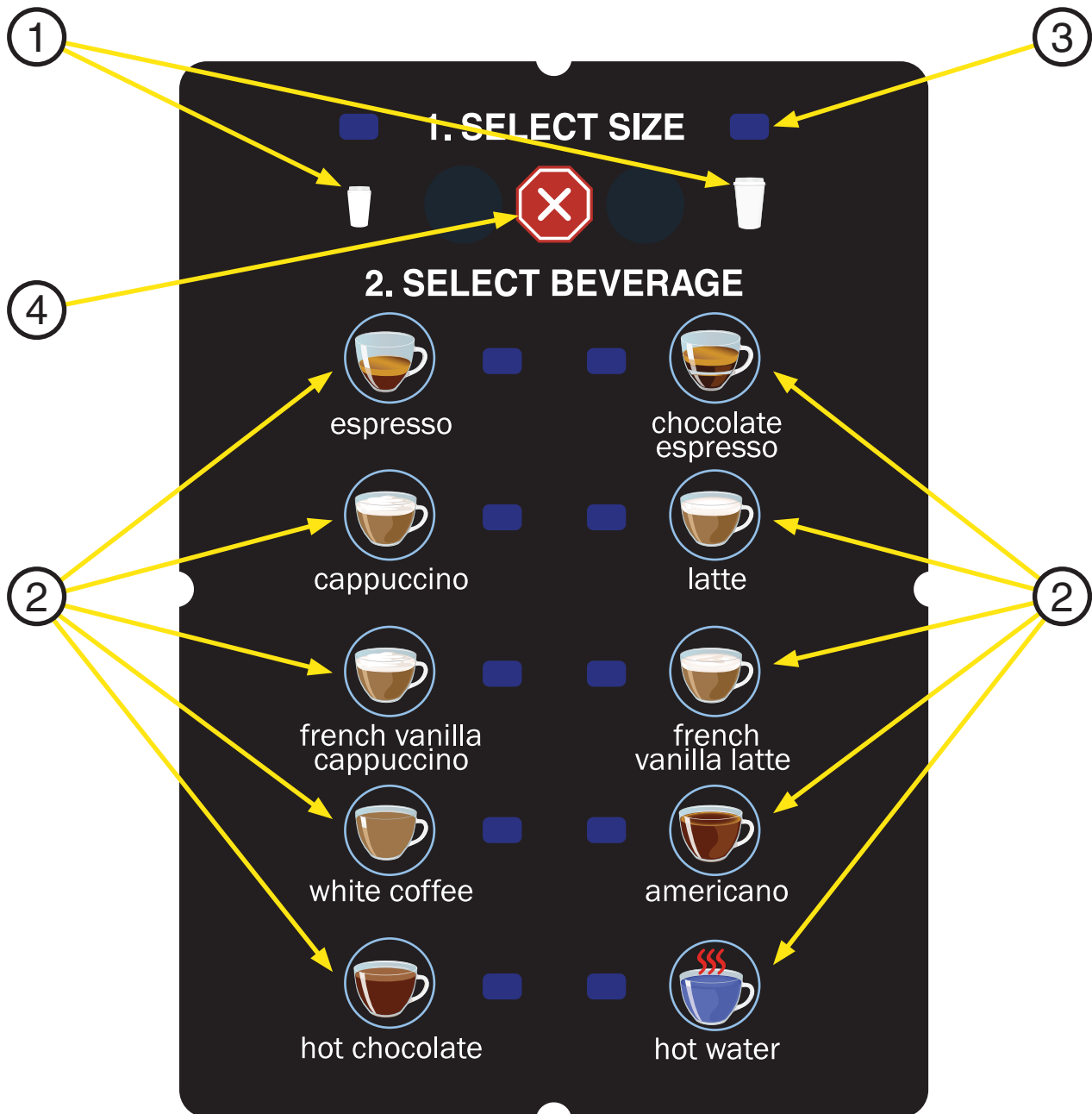

OPERATING THE DISPENSER

NOTE: The NORMAL/PROGRAM/RINSE switch must be in the NORMAL position.

1. Place a cup on the drip tray beneath the dispense nozzle.
2. In the area marked "1" of the control panel:
 - Multi-cup only – Select desired beverage size, small or large cup. This selection is mandatory for dispensing.
3. In the area marked "2" of the control panel:
 - Press the button to dispense the desired beverage. Dispensing is portion controlled, and will automatically stop when the correct amount of beverage has been dispensed.

OPERATING CONTROLS AND INTERFACE

MODIFYING THE TOUCH SWITCH FUNCTIONS

The function of the touch switch can be modified in three different ways:

1. Set for single cup size dispensing.
2. Disable a dispense switch.
3. Create a CUSTOM or ESPRESSO only beverage.

Single Cup Mode

When the SINGLE cup size beverage mode is selected, the large and small cup size buttons are disabled. To dispense a beverage, press only the dispense button of the beverage desired. The option to select which beverage size is used can be done when creating a custom recipe or espresso dispense. *See Crescendo Programming Manual for more information.*

TIP: A display graphic for single cup dispensing is available for purchase from BUNN.

CREATING A “CUSTOM” BEVERAGE

A “CUSTOM” beverage may be edited/created for any dispense switch location. It is recommended that the touch switch graphic insert be replaced with one which matches the beverage reassignments made in this mode. All settings can be adjusted to preference.

► Set Espresso Shots

The sub-menus for adjusting an espresso shot are located under this option.



1. Set the toggle switch to Program mode.

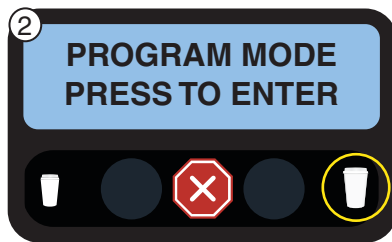

Use to
Navigate

2. Advance to the Set Espresso Shots screen.



Use to
Select

3. Press SELECT.

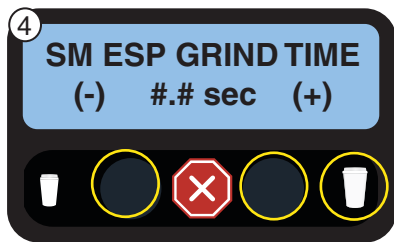

Use to decrease | Use to increase | Use to Navigate

4. Sets the grinder run time for a small espresso shot.
Navigate to the next setting.



Use to
Navigate

5. Press a dispense switch to perform a catch test for a grind.
Navigate to the next setting.

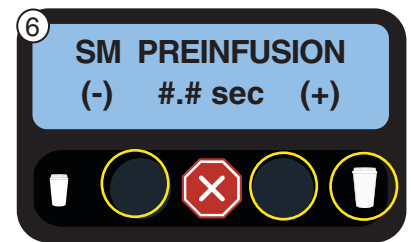

Use to decrease | Use to increase | Use to Navigate

6. Sets the espresso pump run time for pre-infusion of tamped coffee. Zero seconds for no pre-infusion.
Navigate to the next setting.

OPERATING CONTROLS AND INTERFACE

CREATING A “CUSTOM” BEVERAGE (continued)

► Set Espresso Shots (continued)

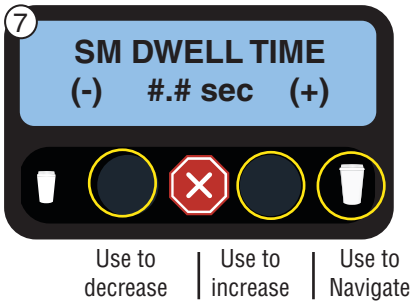

7. Sets the dwell time for a small espresso.
Navigate to the next setting.

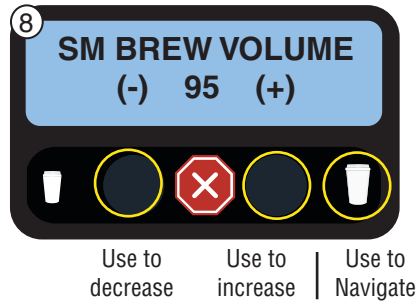

8. Sets the total brew volume for a small espresso shot. The numeric value is flow ticks.
Navigate to the next setting.

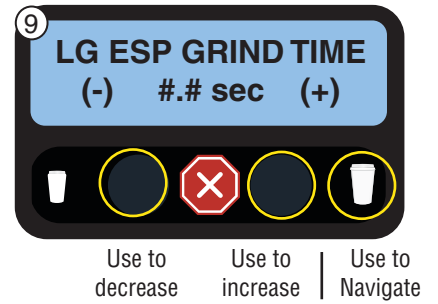

9. The settings will repeat for the large espresso shot.

► Recipe Setup

The sub-menus for adjusting recipes are located under this option.



1. Set the toggle switch to Program mode.

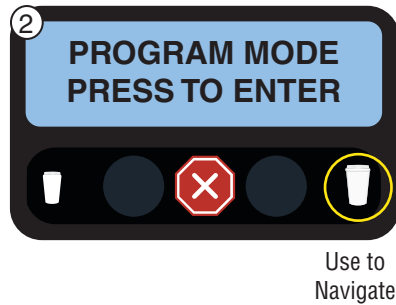

2. Advance to the RECIPE SETUP screen.



3. Press SELECT.

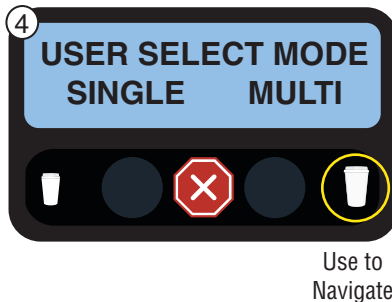

4. Single mode will only allow one size beverage. Multi-drink mode must be selected for setting up small and large beverages.
Navigate to the next setting.

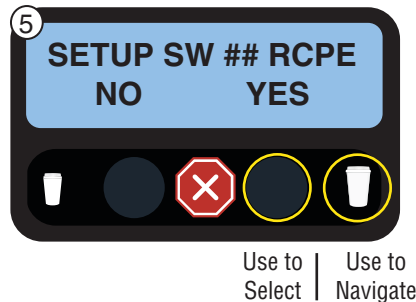

5. You can navigate to any switch to make a custom beverage.
Press SELECT.

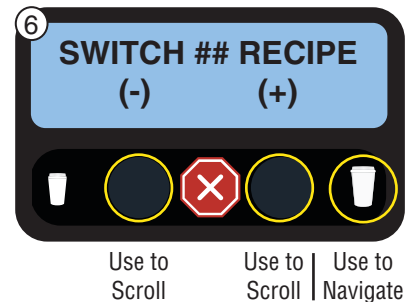

6. Navigate to BEVERAGE to create a CUSTOM beverage recipe.
Press navigate to enter the next setting.

OPERATING CONTROLS AND INTERFACE

► Recipe Setup (continued)

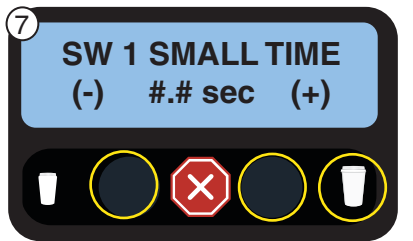

Use to decrease Use to increase Use to Navigate

7. Sets the dispense time for a small beverage.
Single cup mode will have small or large to select from.
Navigate to the next setting.

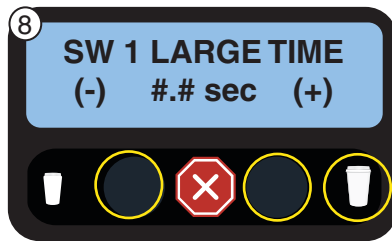

Use to decrease Use to increase Use to Navigate

8. Sets the dispense time for a Large beverage.
Single cup mode will have small or large to select from.
Navigate to the next setting.



Use to select Use to select Use to Navigate

9. Does beverage need an espresso shot? If YES, it will use the corresponding size set for single touch or for the size button selected in Multi.
Navigate to the next setting.

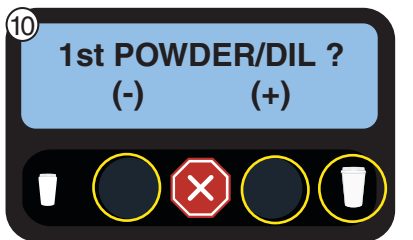

Use to select Use to select Use to Navigate

10. Options are any of three hoppers or dilution. Cannot choose "NONE".
Navigate to the next setting.

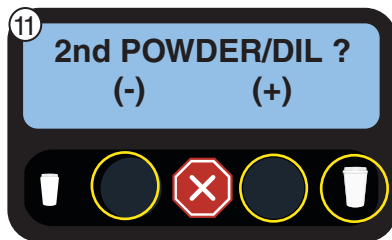

Use to select Use to select Use to Navigate

11. Options are any of three hoppers or dilution. "None" can be selected.
Navigate to the next setting.

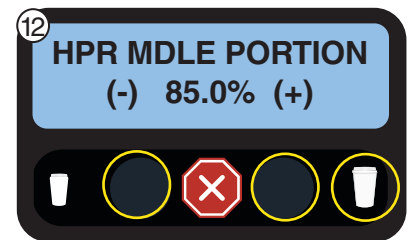

Use to decrease Use to increase Use to Navigate

12. Sets the percentage of run time used for the first selected ingredient.
Navigate to the next setting.

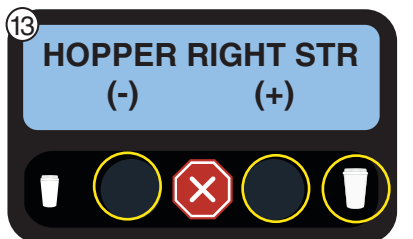

Use to decrease Use to increase Use to Navigate

13. Sets the amount of product used for the recipe that comes from the hopper. If a hopper is not used in the recipe, this screen will not appear.
Navigate to the next setting.



Use to Navigate

14. This will provide a catch test to see how much product dispenses from the hopper.
Navigate to the next setting.

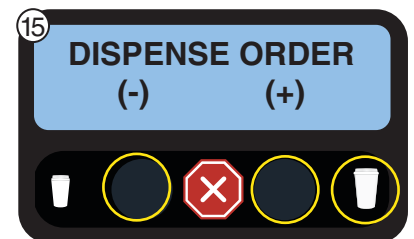

Use to select Use to select Use to Navigate

15. Choose the order in which the ingredients dispense.
Navigate to the next setting.

OPERATING CONTROLS AND INTERFACE

TOUCHLESS SENSITIVITY SELECTION OPTIONS

The Sensitivity option is available for both **TOUCH** and **TOUCHLESS** operation modes. The recommended initial setting for **TOUCH** is “NORMAL”, and the recommended initial setting for **TOUCHLESS** is “HIGH”.

NOTE: Your Crescendo must be fitted with a Gen 2 PCAP with software version 01.20 or higher, and the main I/O board with software version 00.45 or higher to modify the **Touch Settings** on this machine. Go to www.bunn.com to view **Crescendo Programming Manual** or **BUNN Online Learning Center** for more information on updating.

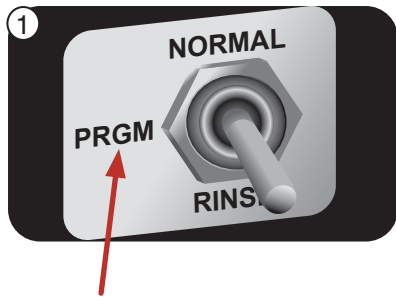

1. Set the toggle switch on inside of the door to Program mode.

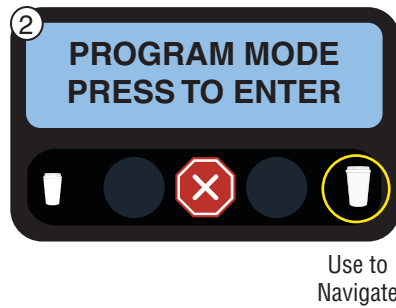

2. Advance to the Calibration screen.

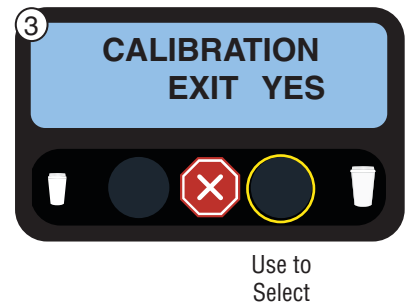

3. Press YES to enter the Calibration sub-menu. Navigate through the sub-menu until you see a screen that says TOUCH SETTINGS.

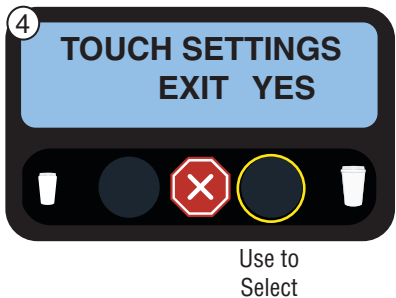

4. Press YES to enter the TOUCH SETTINGS sub-menu.

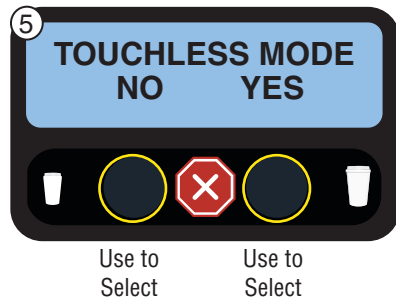

5. Press YES to enable touchless dispense mode. Or, press NO to enable touch dispense mode. Press large cup to navigate to next option screen.



6. Select the sensitivity level for the Touchless or Touch mode chosen on previous screen. **NOTE:** It is recommended to try “Normal” for Touch and “High” for Touchless. Press large cup to navigate to next option screen.

OPERATING CONTROLS AND INTERFACE

TOUCHLESS SENSITIVITY SELECTION OPTIONS (continued)

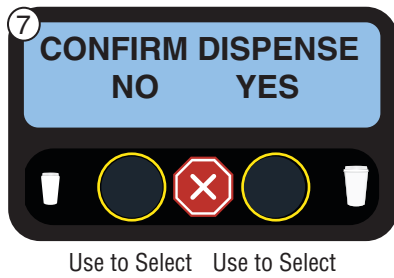

7. The CONFIRM DISPENSE screen allows you to determine if you want to require the user to press the beverage select button twice to get a beverage to dispense.
- If YES is chosen; the selected beverage button will flash its LED while waiting for the user to press it again to begin the dispense process.
 - Press large cup to navigate to next option screen.

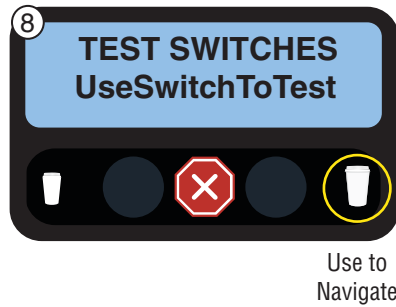

8. This screen allows you to try the 10 beverage dispense buttons with the Touch or Touchless mode and the selected Sensitivity adjustment (Normal to High), to see how the touch panel responds.
- Once done, press the large cup to navigate to next option screen.
 - If you want to try more sensitivity or mode options; press the small cup to navigate backwards.



CONFIRM BEVERAGE SCREENS (when activated)

Screen text examples for multi-touch and single touch operation of the Crescendo machine.

If the CONFIRM BEVERAGE screen is active, it will go there after the beverage is selected and flash the beverage LED until the user selects the beverage again.

If the CONFIRM DISPENSE option is not active, then the beverage should begin to dispense as soon as the beverage key is selected the first time.

The CONFIRMATION screen will time out after 20 seconds of inactivity, and will also cancel out if the user presses any other buttons on the touch panel.

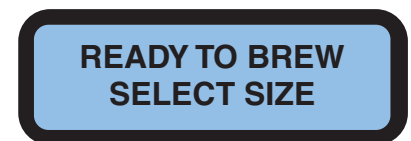

Multi-Touch Selection Screens

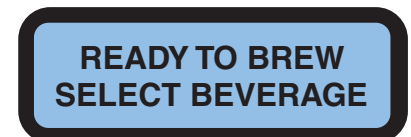

Single Touch Selection Screen

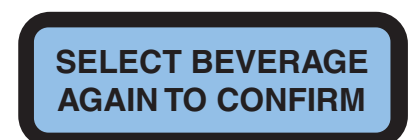

Confirm Beverage Screen

DOOR SAFETY INTERLOCK

The dispenser is equipped with a door interlock safety switch, which prevents the operator from being exposed to the moving parts of the espresso brewer if the door is open.

The switch may be overridden by a qualified service technician by inserting the service key, (BUNN PN 51953.0001) into the opening of the mixing chamber panel, then turn about 15 degrees to position, as shown in Figure 2.

Service Key

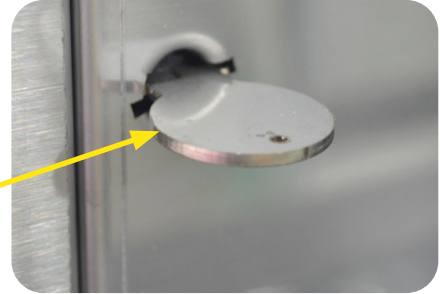

Figure 2

THROUGH COUNTER OPTION

The machine can be setup to dispose of the used coffee grounds through an opening in the counter, into a waste bin, for higher waste capacity.

Countertop and Machine Modifications for Through Counter Waste Option

1. Use template (Bunn #54427.0000) to locate the cutout hole in the countertop.
2. Open the front door on Crescendo, and remove the grounds bin.
3. Remove the two screws that secure the grounds bin support panel, then remove the panel.
4. Remove screw holding the chassis bottom cover, then remove the cover.
5. Used coffee puck will now fall through the opening in the chassis.
6. Position the Crescendo so that the opening in the bottom of the machine coincides with the hole in the countertop.
7. To direct the brewing waste water through the counter, disconnect the drain tube from the fitting on the bottom of the espresso drive.
8. Connect a 5MM ID tube to the drain fitting, and direct the tube through the opening in the bottom of the chassis.

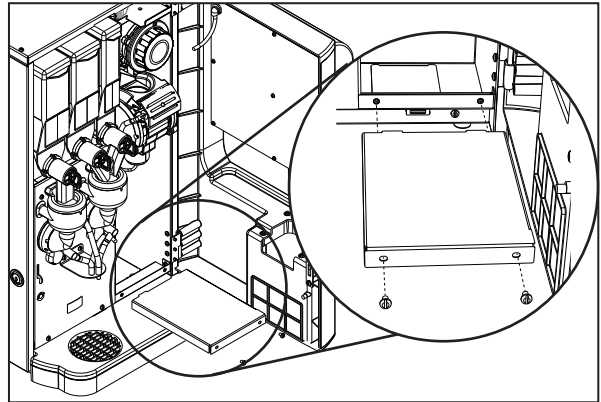

Remove grounds bin support panel

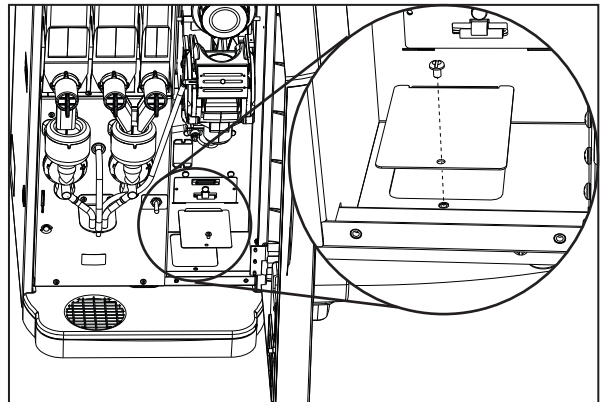

Remove the chassis bottom cover

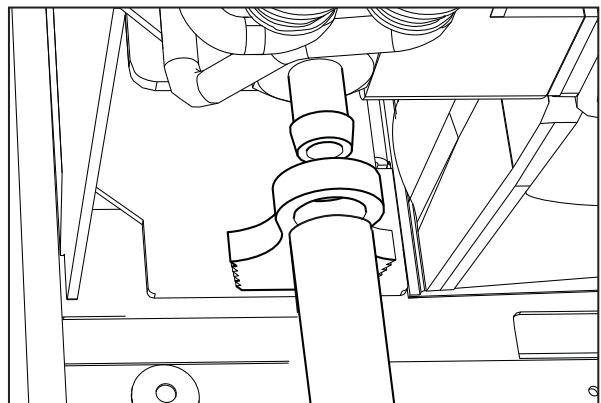

Connect a 5MM ID tube to the drain fitting

THROUGH COUNTER OPTION

Software Setup for Through Counter Option

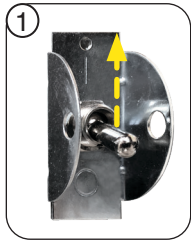

1. Power the machine.



2. Place in PROGRAM mode.

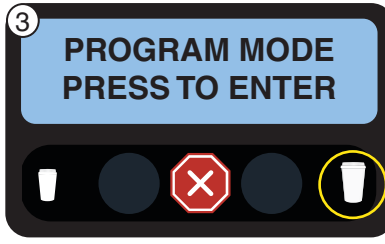

Use to Navigate

3. Press the LARGE cup button to navigate to the LOCKS/DISABLES menu.

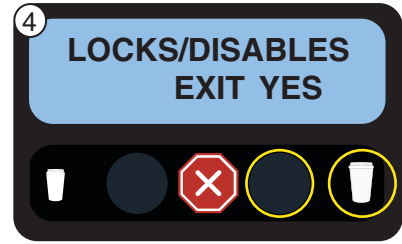

Use to select | Use to Navigate

4. Press the YES button, then the LARGE cup size button until the screen displays the PUCK BIN screen.



Use to select

5. In the default menu, YES will be flashing. Press the button under NO to disable the PUCK BIN mode.



Use to select

6. When NO is flashing on the display, press the button under EXIT to return to the main screen.



7. Place the NORMAL/PROGRAM/RINSE switch to the NORMAL position.

ENERGY SAVER MODE

In this mode, the machine will operate in a low power mode during off hours to save energy. The display backlight will be turned off, and the display message will toggle between “Energy Saver/Mode Enabled” and “Change to Normal/Mode to Clear”. The dispense buttons are disabled so that no beverage dispensing is allowed. The tank refill and powder (soluble) tank heater are disabled. The espresso tank temperature setting is reduced to 130°F (54°C).

To enable Energy Saver Mode

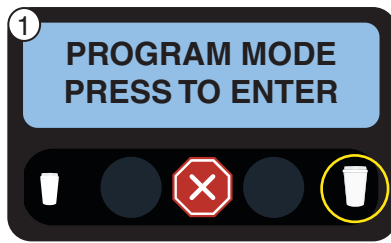

Use to Navigate

1. In PROGRAM mode, press the LARGE cup button to navigate to the LOCKS/DISABLES menu.



Use to select | Use to Navigate

2. Press the YES button, then the LARGE cup size button until the screen displays the ENERGY SAVER? screen.



Use to select

3. In the default menu, NO will be flashing. Press the button under YES to enable the ENERGY SAVER mode.



Use to select

4. When YES is flashing on the display, press the button under EXIT to return to the main screen.



5. Place the NORMAL/PROGRAM/RINSE switch to the NORMAL position.

ENERGY SAVER MODE

To place the unit in ENERGY SAVER Mode



1. Open the door, and place the NORMAL/PROGRAM/RINSE switch in the RINSE position.



2. After ten minutes with the switch in the RINSE position, the ENERGY SAVER mode will become active.

NOTE: If a rinse cycle has taken place, and the switch is left in the RINSE position, the ENERGY SAVER mode will become active ten minutes after the rinse cycle was completed. To exit the ENERGY SAVER mode, return the NORMAL/PROGRAM/RINSE switch to the NORMAL position.

GENERAL CLEANING

The use of a damp cloth rinsed in any mild, non-abrasive, liquid detergent is recommended for cleaning all surfaces on Bunn-O-Matic equipment.

Exterior Surfaces

- Do not use any abrasive materials.
- Use a soft, dry cloth to wipe down the exterior surfaces of the dispenser to maintain the luster of the stainless steel finish.
- Wash the stainless steel exterior surfaces of the dispenser with warm, soapy water. Rinse with warm, clear water. If the water is hard, wipe the dispenser dry with a soft cloth to prevent water spotting.
- Stainless steel polish may be used if it is sprayed on a cloth before the cloth is used to wipe down the exterior surfaces of the dispenser.

DAILY: Parts Washing

1. Remove and wash the drip tray and drip tray cover in a mild detergent solution. Rinse thoroughly.
2. Wipe the lower front panel, door, and cabinet with a clean damp cloth.

WEEKLY: Parts Washing

1. Remove the elbows and slide gates from all hoppers. Disconnect the elbows from the outlets of both mixing chambers.
2. Remove the powder mixing chambers, steam traps, frothers and mixing chamber bases.
3. Remove the dispense hoses from the dispense nozzle assembly.
4. Clean all parts removed in warm soapy water. Use Bunn P/N 26367.0000 or 49827.0000 cleaning brush provided to clean bores and orifices. Rinse in cold water.
5. Prepare one-gallon (3.8 liter) of sanitizing solution with at least 100 ppm of available chlorine in 120°F (48.9°C) water. Soak all cleaned parts in sanitizing solution for 5 minutes, then allow to air dry.
6. Rinse cleaning brush, dip in sanitizing solution, and brush the bore of both dispense nozzles.

NOTE: Repeat this procedure for each nozzle separately.

7. When reassembling parts, be sure to align arrow on frother disk with flat on whipper motor shaft, and rotate tab on whipper base clock wise to the vertical position to lock mixing chamber.

CLEANING



1 x 24h



1. Rinse out Whipper Chambers by placing the RUN/PROGRAM/RINSE switch in the RINSE position, then press the button under RINSE followed by pressing any beverage dispense button.
2. Push the slide gates on the front of the hopper elbows inward to close. Remove hoppers, refill with product, and replace hoppers into dispenser.
3. Empty Drip Tray and wash in a solution of dish detergent.

1. Lave la cámara de batido colocando RUN/PRO GRAM/RINSE en la posición de lavado RINSE, y apretar el botón bajo RINSE. Luego aprete cualquier botón dispensador de bebida.
2. Empuje la compuerta deslizante en frente de los codos de la tolva para cerrarla. Retire las tolvas, llene con el producto y reemplace la tolva en el dispensador.
3. Vacie la bandeja de goteo y límpiela con un detergente líquido suave no abrasivo.



1 x 7d

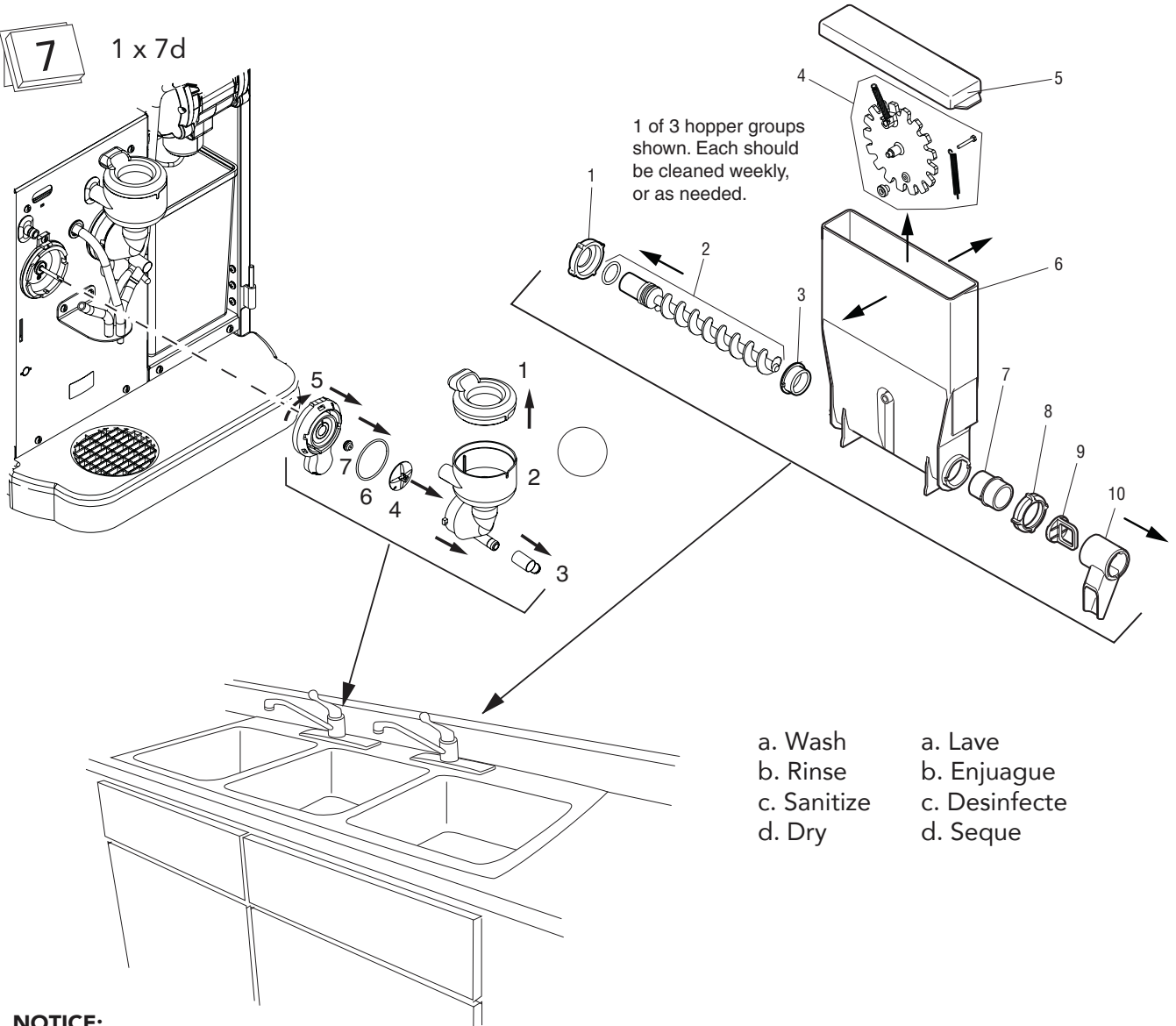

NOTICE:

The cleaning instructions noted above are for non-dairy sugar based food products. When dispensing any other food product, the cleaning cycle for the whipping chamber assembly and ejector elbow must be performed daily.

NOTA:

Las instrucciones de limpieza descritas anteriormente excluyen productos lácteos azucarados. La limpieza de las cámaras de mezcla y de los codos de salida de cada tolva deberá realizarse diariamente.

CLEANING

RINSE CYCLE (Required Daily)

1. Open the door and place the NORMAL/PROGRAM/RINSE switch in the RINSE position.
2. Close door and place a minimum 400ml container under the dispense nozzles.
3. Press the button under RINSE on the screen.
4. Press any beverage selection button.
5. The dispenser will automatically run hot water through both soluble mixing chambers, and flush the espresso brew chamber with hot water.
6. After rinse cycle is complete, discard the rinse water collected in the container.
7. Open the dispenser door, and place the NORMAL/PROGRAM/RINSE switch in the NORMAL position.

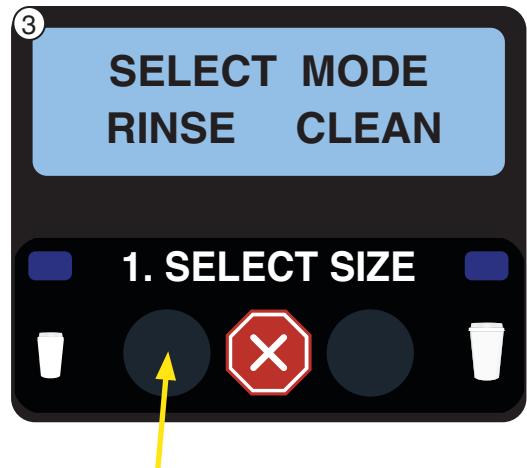
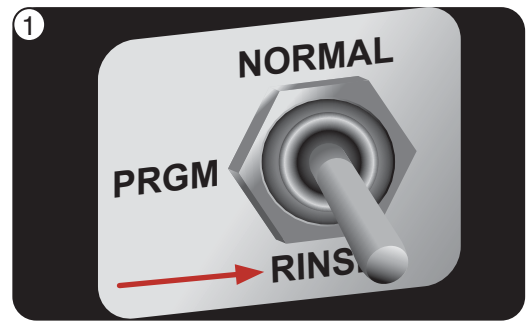

CLEANING

CLEAN CYCLE: Weekly

1. Open the door and place the NORMAL/PROGRAM/RINSE switch in the RINSE position.

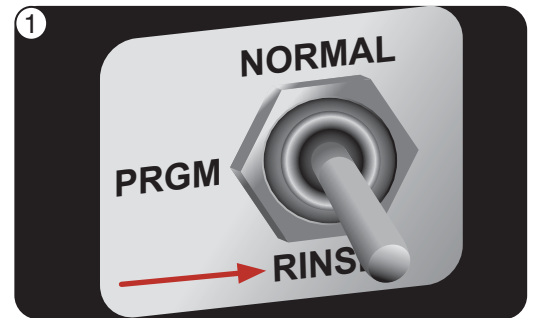

2. Press the button under CLEAN on the screen.

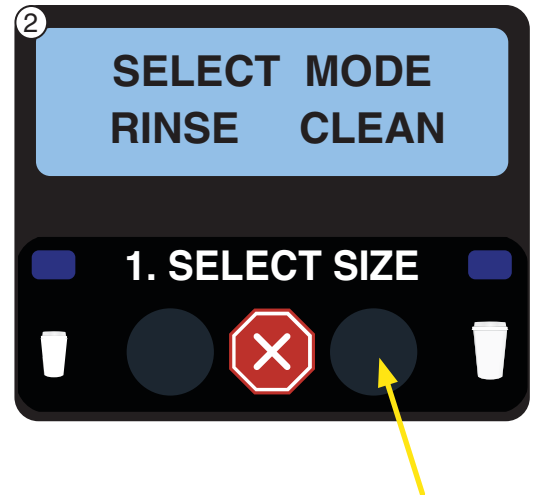

3. When the screen prompts ADD CLEANING TABLET, open the dispenser door, and drop a cleaning table into the opening of the espresso brew chamber as shown.

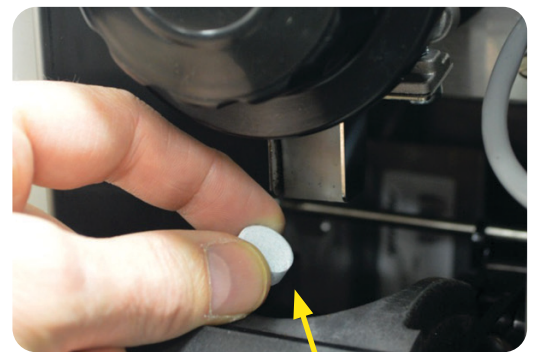

Add cleaning
tablet here

CLEANING

CLEAN CYCLE: Weekly (continued)

4. Close dispenser door and place a minimum 500ml container under the dispense nozzles.

5. Press the button under NEXT.

6. When screen displays PRESS DISPENSE TO START, press any beverage dispense button to begin cleaning cycle.

7. During the cleaning cycle, the screen will display CLEANING CYCLE IN PROGRESS/PRESS  TO STOP.

8. When the cleaning cycle is complete, screen will display SELECT MODE/ RINSE__ CLEAN.

9. Discard the waste water collected from the cleaning cycle.

10. Open the dispenser door, and place the NORMAL/PROGRAM/RINSE switch in the NORMAL position.

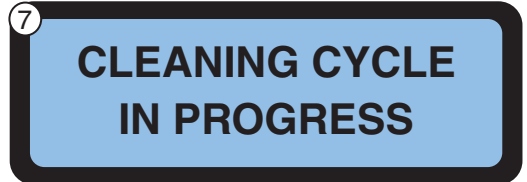

CLEANING

WEEKLY: Parts Washing and Sanitizing

► WHIPPER COMPONENTS

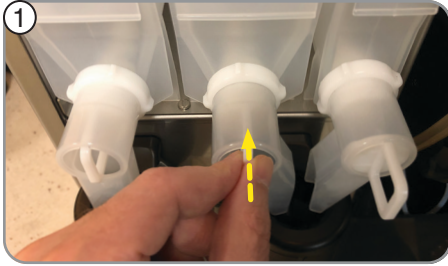

1. Push slide gates on the hopper elbows in to close.



2. Remove hoppers.



3. Remove the elbow fittings from both mixing chambers.



4. Rotate tab at bottom of mixing chamber bases. Twist counter clockwise to release bases.



5. Remove mixing chambers by pulling straight out.

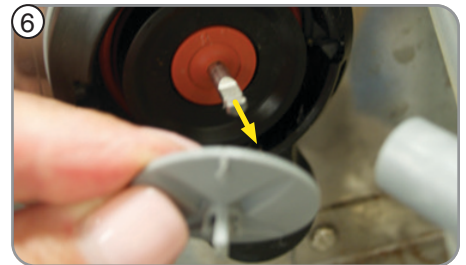

6. Remove frother disks (Impellers) from shafts by pulling straight out.



7. Rotate tab on mixing chamber bases further counter clockwise, and remove from shafts by pulling straight out.



8. Use flat brush to clean dispense tube connectors area.

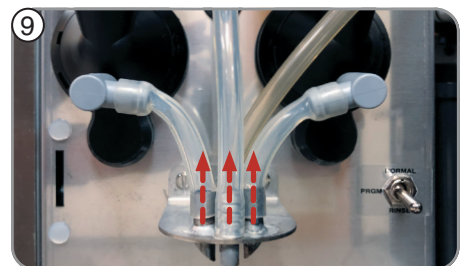

9. Remove dispense tubes from dispense nozzle assembly.



10. Prepare one-gallon (3.8 liter) of sanitizing solution with at least 100 ppm of available chlorine in 120°F (48.9°C) water. Clean all parts in compartment sink.

NOTE: Do not use any abrasive materials.



11. Rinse parts thoroughly.



12. Soak all cleaned parts in sanitizing solution for 5 minutes, then allow to air dry.

CLEANING

WEEKLY: Parts Washing and Sanitizing (continued)

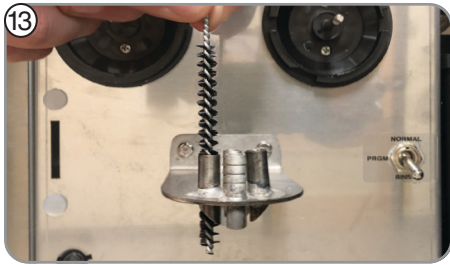

13. Rinse cleaning brush, dip in sanitizing solution, and brush the bores of the dispense nozzles. Repeat this procedure for each nozzle separately.

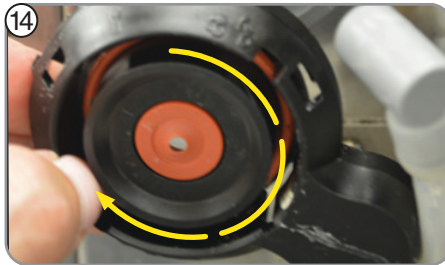

14. Replace whipper base. Rotate tab on whipper base clockwise to the vertical position to lock mixing chamber.

NOTE: Ensure O-ring and shaft seal are in place during re-assembly.

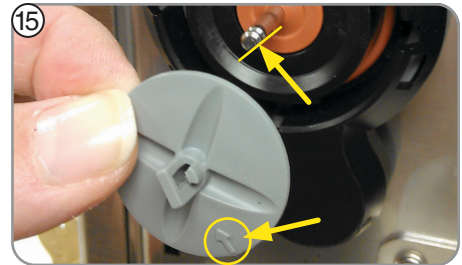

15. Replace frother disks. Confirm that the arrows are aligned with the flat side of the whipper motor shafts.

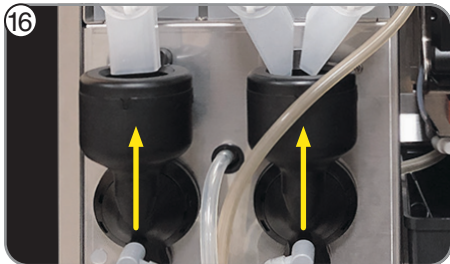

16. Replace mixing chambers.

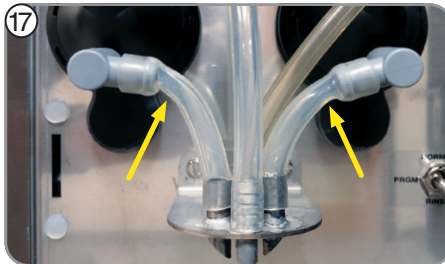

17. Replace dispense tubes.

NOTE: Confirm tubes don't kink.

► HOPPER COMPONENTS



1. If not already removed, push the slide gates on the hopper elbows in to close.

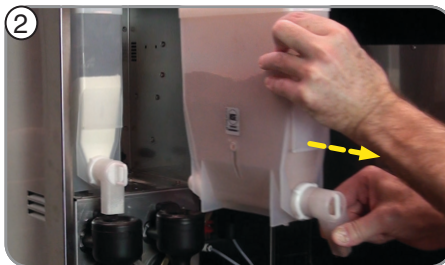

2. Remove hoppers, and empty product in a separate clean container.



3. Remove powder hopper dispense elbow.

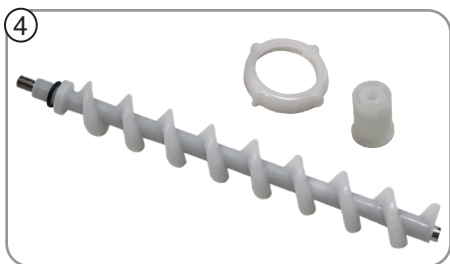

4. Remove rear auger nut, then pull the auger and the rear auger bearing out of the hopper.



5. Remove mixing wheel with springs from hopper by spreading the hopper side wall with hand to release wheel from hopper.



6. If not already done, prepare one gallon (3.8 liter) of sanitizing solution with at least 100 ppm of available chlorine in 120°F (48.9°C) water.

CLEANING

WEEKLY: Parts Washing and Sanitizing (continued)

► HOPPER COMPONENTS (continued)



7. Clean all parts in a 3 compartment sink. Do not use any abrasive materials.

Rinse parts thoroughly.

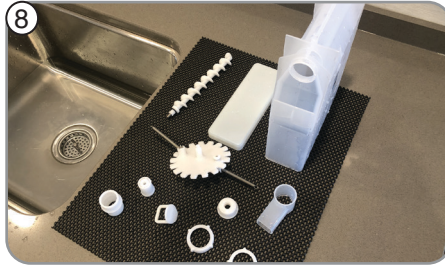

8. Soak all cleaned parts in sanitizing solution for 5 minutes, then allow to air dry.



9. Reassemble each hopper.



10. Refill hoppers with product.



11. Reinstall hoppers onto compartment platform. Ensure auger and hopper locator peg are properly seated in position.

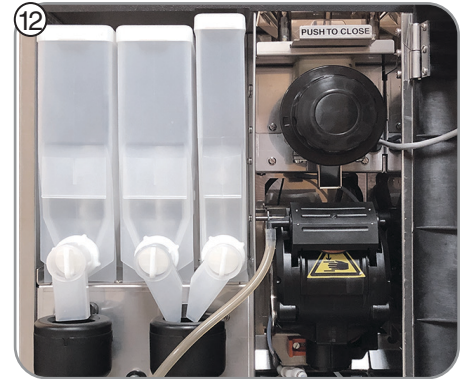

12. All hoppers re-installed.

BI-WEEKLY (or Every 1,000 Cycles): Espresso Brew Chamber

► REMOVE BREW CHAMBER FROM ESPRESSO DRIVE



Brew Chamber

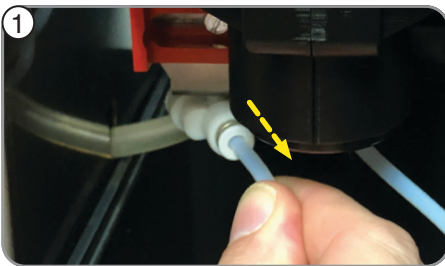

1. Remove water inlet tube.
NOTE: To release, press ring on fitting, and pull tube out.

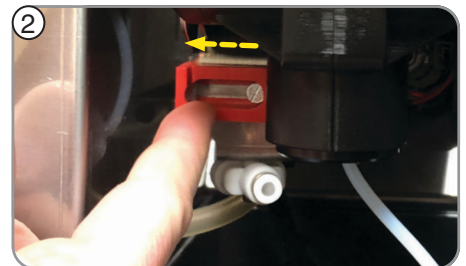

2. Slide red lock to left to unlock.

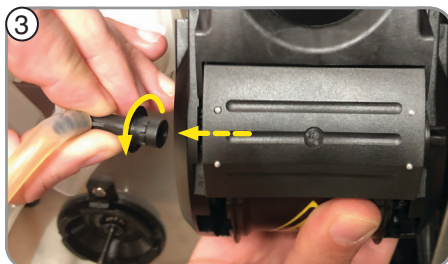

3. Remove brew chamber outlet tube.
NOTE: Turn elbow until it releases from hole.

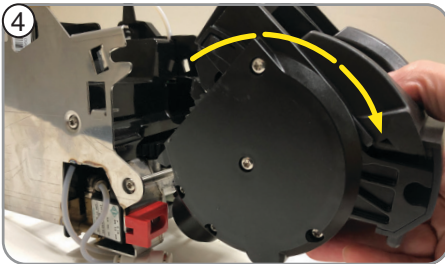

4. Pull brew chamber group out.

CLEANING

► SEPARATING BREW CHAMBER PARTS

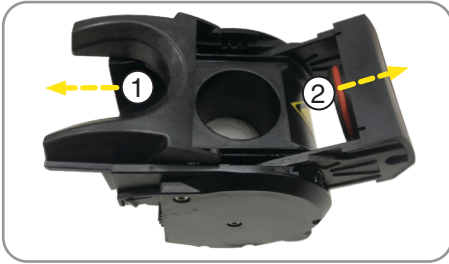

1. Slide cake pusher forward.
2. Pull sieve head out from brew chamber.



3. Remove cake pusher.



4. Remove sieve head.

> CLEANING BREW CHAMBER PARTS



1. Brush espresso drive gears.



2. Brush sieve head.
NOTE: Pay special attention to the channels.

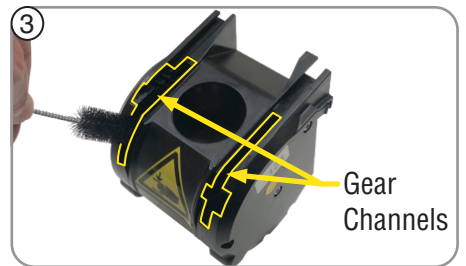

3. Use brush to clean brew chamber housing and gear channels.

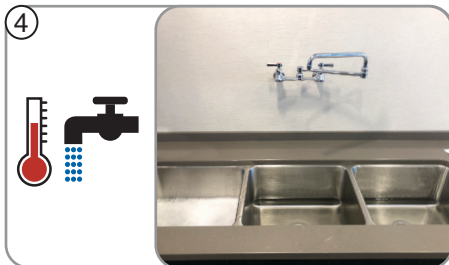

4. Use lukewarm water only to rinse all parts.

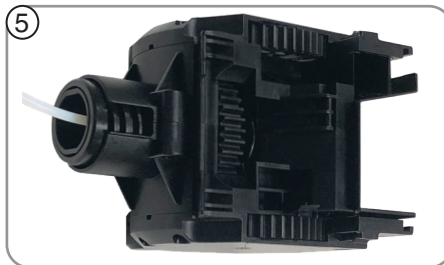

5. Clean all sides of brew chamber.
NOTE: Turn gears in back of brew chamber to clean all sections.



6. Clean cake pusher and sieve head in warm water.



7. Place all parts out to dry.

CLEANING

BI-WEEKLY (or Every 1,000 Cycles): Espresso Brew Chamber (continued)

► REASSEMBLING GROUP HEAD

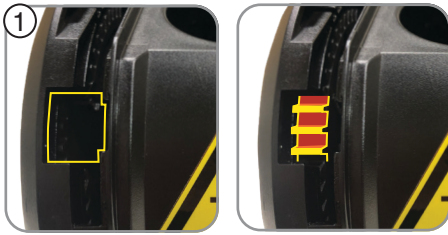

Correct

Incorrect

1. Confirm all gears are aligned, and the slots to put the sieve head are open.

NOTE: Gap in gears should be showing.

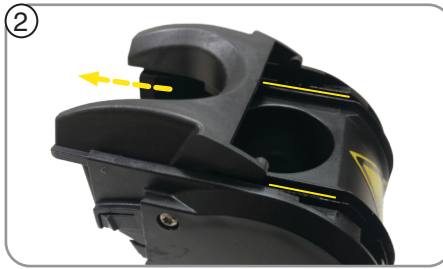

2. Replace cake pusher in channels.

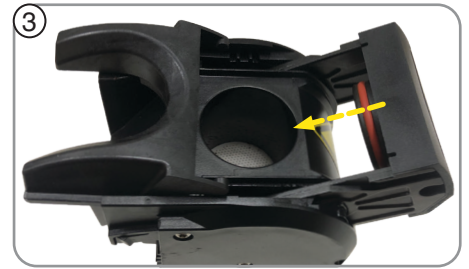

3. Place sieve head in gear opening, and push in.

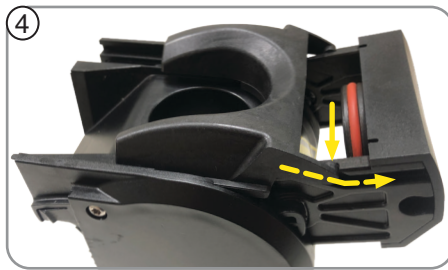

4. Align cake pusher tabs into slots on sides of sieve head.

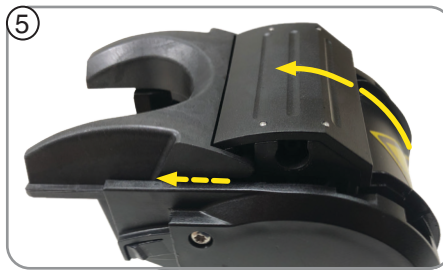

5. Press sieve head and cake pusher forward until seated.

► REATTACHING GROUP HEAD TO ESPRESSO DRIVE

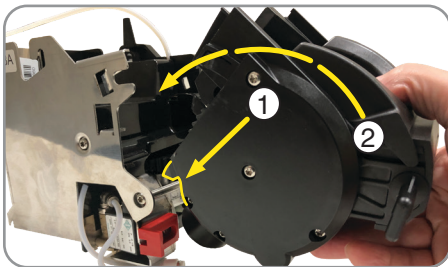

1. Place groove on lower front of brew chamber onto mounting bar on espresso drive.

2. Rotate the top of group head toward rear of machine until it snaps into place.

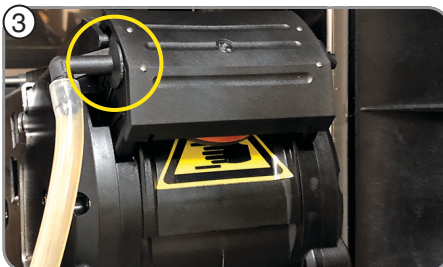

3. Connect brew chamber outlet tube.

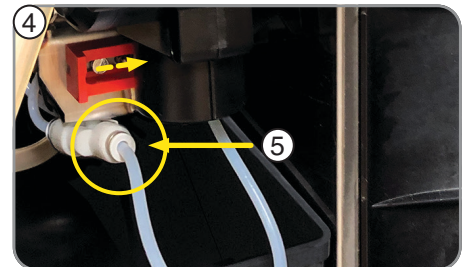

4. Slide red lock to right until it locks.

5. Connect water inlet tube.



6. Place the NORMAL/PROGRAM/RINSE switch in the NORMAL position.



7. Close door.

PREVENTIVE MAINTENANCE

Bunn-O-Matic® Corporation recommends that preventive maintenance be performed at regular intervals. Maintenance should be performed by a qualified service technician. For Technical Service, contact Bunn-O-Matic Corporation at 1-800-286-6070.

NOTE: Replacement parts or service caused by failure to perform required maintenance is not covered by warranty.

Cycle (months)	Item	Part Number
6	PM KIT, 6 MONTHS CRESCENDO	54866.0000
12	PM KIT, 12 MONTHS CRESCENDO	54867.0000

ADJUSTMENTS

Adjustable Variables Used to Create A Perfect Shot of Espresso Topped with Crema

The primary 2 variables that you will adjust to achieve your ideal double shot espresso pour time will be the coffee particle size and the dosage targets.

Variables

1. Coffee Particle Size: See "Adjust the Coffee Particle Size" below.
2. Espresso & Water Dosage: Adjustable
3. Espresso Water Temperature: Factory Default Setting is 215° F. Adjustable from 190°-218°

Defaults		
Single	7 g	30 ml
Double	12 g	60 ml

Brew/Pour Time Target

- 17-23 seconds from when grinder stops to cup takeaway.

NOTE: Adjustments are optimized for double shots. The single shot pour time will be shorter because of less water.

Once the double shot has been calibrated, the grinder coarseness adjustment is complete. The only adjustment to perform is setting the espresso & water dosage for a single shot espresso.

Adjust the Coffee Particle Size

The particle size of the ground coffee can be adjusted for optimal espresso brewing.

DO NOT change the grind particle size significantly. Change coffee coarseness in 1 hashmark increments, as it will change the grind rate, thus the amount of coffee ground and brew/pour time.

The grinder adjustment screw will be set from the factory to an approximate particle size setting for espresso (11 Hashmarks).

1. First, ensure espresso beans are in the hopper. Open the door, and slide the espresso brew group lock to the left to unlock the brew group. Tip the top of the brew group head towards the front of the machine to disengage from the espresso drive, then remove brew group from the drive.
2. Enter program mode and scroll to SET ESPRESSO SHOTS menu. Enter and scroll to TEST LG GRIND TIME menu. Place cup under grinder chute to catch coffee grounds during grind adjustment. Press the espresso button to start the grinder dispense timer. Adjust the grinder adjustment screw **ONLY WHILE THE GRINDER IS OPERATING** until the grind particle size is desired or matches a desired grind sample.
3. After setting the grind particle size, tare (zero) cup on weigh scale, then place cup under grinder chute and press the espresso button to start the grinder dispense timer. Then, weigh the dispensed grounds. Adjust the grind time and keep repeating the grind throw test until desired weight is achieved.

NOTE: Steps 1 thru 3 will take some back and forth adjustments to achieve the target brew time. You should end up with a dark color espresso, topped with a tan colored crema.

ADJUSTMENTS

(continued from previous page)

- Next, scroll through sub menus until LG BREW VOLUME is displayed. Ensure the tic number is set to your desired finished shot amount.

NOTE: 3.0 tics = 1.0 mil, Default 190 tics divide by 3.0 = 63.33 mils. This is your brew volume target 63.33mils for a double shot. The extra 3.33 mils most likely will be absorbed in the espresso puck resulting around 60 mils of finished product/double shot.

- Reinstall the brew group, return switch to the NORMAL position and close door. Make a large espresso to see if your brew/pour time is within the 17-23 seconds.

NOTE: Anytime you make an adjustment to the coffee coarseness, a shot must be discarded between adjustments. If the pour is too slow or too fast, repeat all steps until you are within the 17-23 seconds brew time.

Style: Adjustment Knob (Figure 1)

The particle size of the ground coffee can be adjusted for optimal brewing of the espresso.

NOTE: BUNN recommends to rotate knob in 1 click increments to achieve desired coarseness.

- Turn knob counterclockwise to increase the particle size (coarse) of the ground coffee.
- Turn the knob clockwise to decrease the particle size (fine) of the ground coffee.

CAUTION! If there is ground coffee in the grinder, this adjustment should only be made while the grinder is running.

- Use SET ESPRESSO SHOTS, TEST SM or LG GRIND functions to operate the grinder for making particle size adjustment.



Adjustment Knob

Style: Grinder Adjustment Screw with Locking Nut (Figure 2)

The particle size of the ground coffee can be adjusted for optimal espresso brewing. The lock nut replaces the grinder knob to prevent tampering of grind adjustment.

NOTE: BUNN recommends to rotate adjustment screw in 1 hashmark increments to achieve desired coarseness.

- The grinder adjustment screw will be set from the factory to an approximate particle size setting for espresso (11 Hashmarks).
- Loosen locknut and use large flat blade screwdriver to rotate adjustment screw clockwise or counter clockwise to desired particle size, use screwdriver to hold adjustment screw while tightening lock nut.

CAUTION! If there is ground coffee in the grinder, this adjustment should only be made while the grinder is running

- Use SET ESPRESSO SHOTS, TEST SM or LG GRIND functions to operate the grinder for making particle size adjustment.

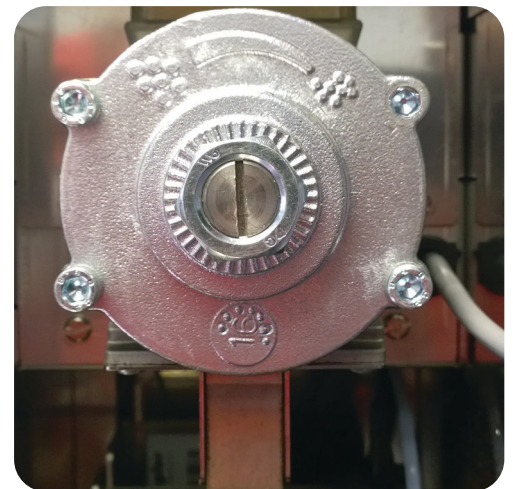

Adjustment Screw with Locking Nut

ADJUSTMENTS

Procedure Setting Grinder Adjustment Screw Back to Factory Setting

The procedure for setting the adjustment screw back to a factory setting after dismantling and cleaning the burrs.

1. Bean hopper removed or chute closed. Place switch in Program position. Go to display screen and scroll to “SET ESPRESSO SHOTS” menu. Enter and scroll to “TEST LG GRIND TIME” menu. Loosen locknut and use large flat blade screwdriver to rotate adjustment screw. Press the espresso button to start the grinder motor, while the motor is running, slowly rotate the adjustment screw inside the nut clockwise. When a “chirping” sound of the burrs touching is heard, rotate counter clockwise just until the chirping stops.
2. Reference the adjustment screw slot and mark the burr rotor cap with 0. Then rotate the adjustment screw 11 hashmarks counter clockwise from 0 to set back to a factory setting. Mark the burr rotor cap to indicate 11 hashmark setting. Holding the screw with the screwdriver, tighten the hex nut. Make sure after tightening nut, the setting is still lined up at the 11 hashmarks from zero.

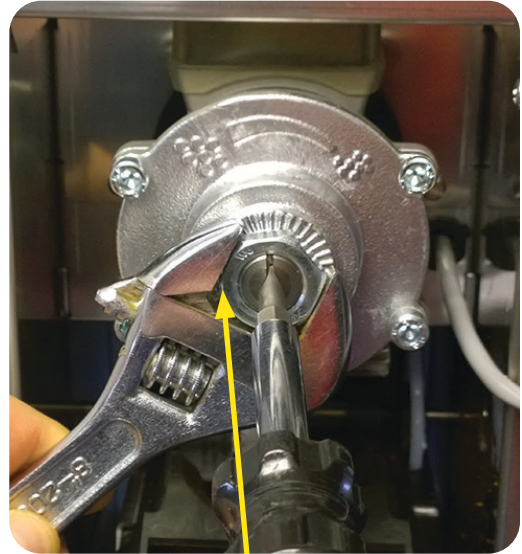

Loosen Locking Nut to allow Adjustment Screw to move

Grinder Throw Weight Adjustment

1. Open the door, and slide the espresso brew group lock to the left to unlock the brew group.
2. Tip the top of the brew group head towards the front of the machine to disengage from the espresso drive, then remove brew group from the drive.
3. Place the NORMAL/PROGRAM/RINSE switch in the PROGRAM position.
4. Press the Large Cup button to the SET ESPRESSO SHOTS menu, then press the button under YES.
5. Press the Large Cup button to TEST SM GRINDTM.
6. Place a small container on a scale, and tare container.
7. Hold the container under the grinder chute, and press any beverage dispense button.
8. Grinder will run for the time set for a small (single shot) espresso, then stop.
9. Repeat several times, and average the weight.
10. To change the weight, press the Small Cup button to SM ESP GRIND TIME.
11. Use the buttons below the (-) and (+) button to increase or decrease the grind time.
12. Press the Large Cup button to TEST SM GRIND to test new grind time.
13. Press the Large Cup button to TEST LG GRIND to test the large (double shot) grind weight.
14. Press the Small Cup button to LG ESP GRIND TIME to adjust the grind time for a large (double shot) espresso, if required.
15. After the grind adjustments have been tested and adjusted, place the NORMAL/PROGRAM/RINSE Switch in the NORMAL position, and exit program mode.
16. Reinstall the espresso group head back onto the espresso drive.

DRAINING THE HOT WATER TANKS

To be performed by qualified service personnel only!

1. Open the door and place the NORMAL/PROGRAM/RINSE switch in the PROGRAM position. (Figure 1)
2. Close the door and place a minimum two liter container under the dispense nozzles.
3. Press the Large Cup button until the screen reads DIAGNOSTICS.
4. Press, in sequence, buttons 3, 7, 4 and 1. See Figure 2 for button number designations.
5. The screen will display SYSTEM WET TEST. Press the button under YES.
6. Press the button under COOL ESP TANK.
7. Press the button under START in the COOL ESP TANK screen.
8. The pump will begin running, and hot water will dispense into the container. After 4 minutes, the pump will automatically stop.
9. In the ESP TANK COOL? screen, press the button under YES.

NOTE: Dispenser must be OFF and disconnected from the power source in steps 10 through 24.

10. Immediately turn OFF and disconnect the dispenser from the power source, and water supply.
11. Let the water in the soluble tank cool before draining.
12. Remove left side panel.
13. Pull the drain tube out of the dispenser and direct it into a drain or a container large enough to hold the volume of water in the tank, approximately 6 liter (1.5 gallon).
14. Pinch tube and remove the plug from end of the tube.
15. After the tank has drained, replace the plug in the end of the tube.
16. Remove the tube from the connector in the bottom of the espresso tank.
17. Swivel the tube towards the outside of the machine.
18. Empty the container used to capture the hot water from the tank, and place it on the right side of the machine.
19. Insert a 6mm OD tube into the espresso tank fitting, place the other end into the container.
20. Use a 4mm hex wrench to loosen the plug on the top of the espresso tank, until the tank begins to drain.
21. After the tank is drained, retighten the plug.
22. Remove the drain tube from the bottom tank fitting.
23. Rotate the fitting towards the inside of the tank. Compressing the release sleeve on the fitting, fully insert the pump tube.
24. Replace the left and right side panels.

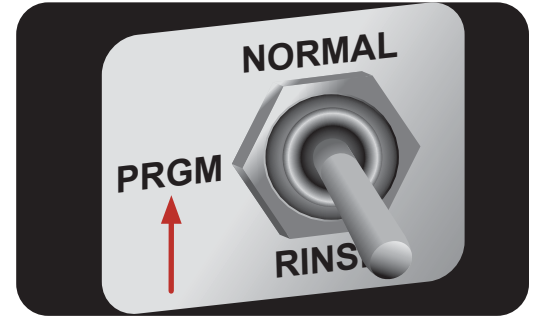

Figure 1

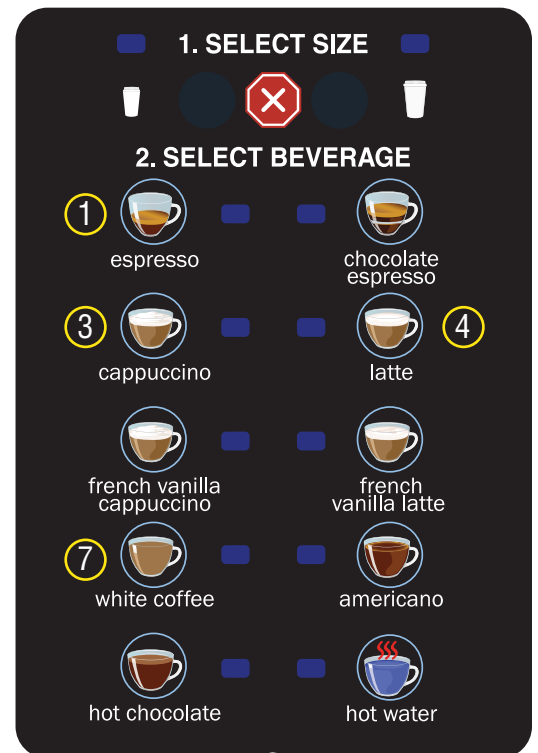
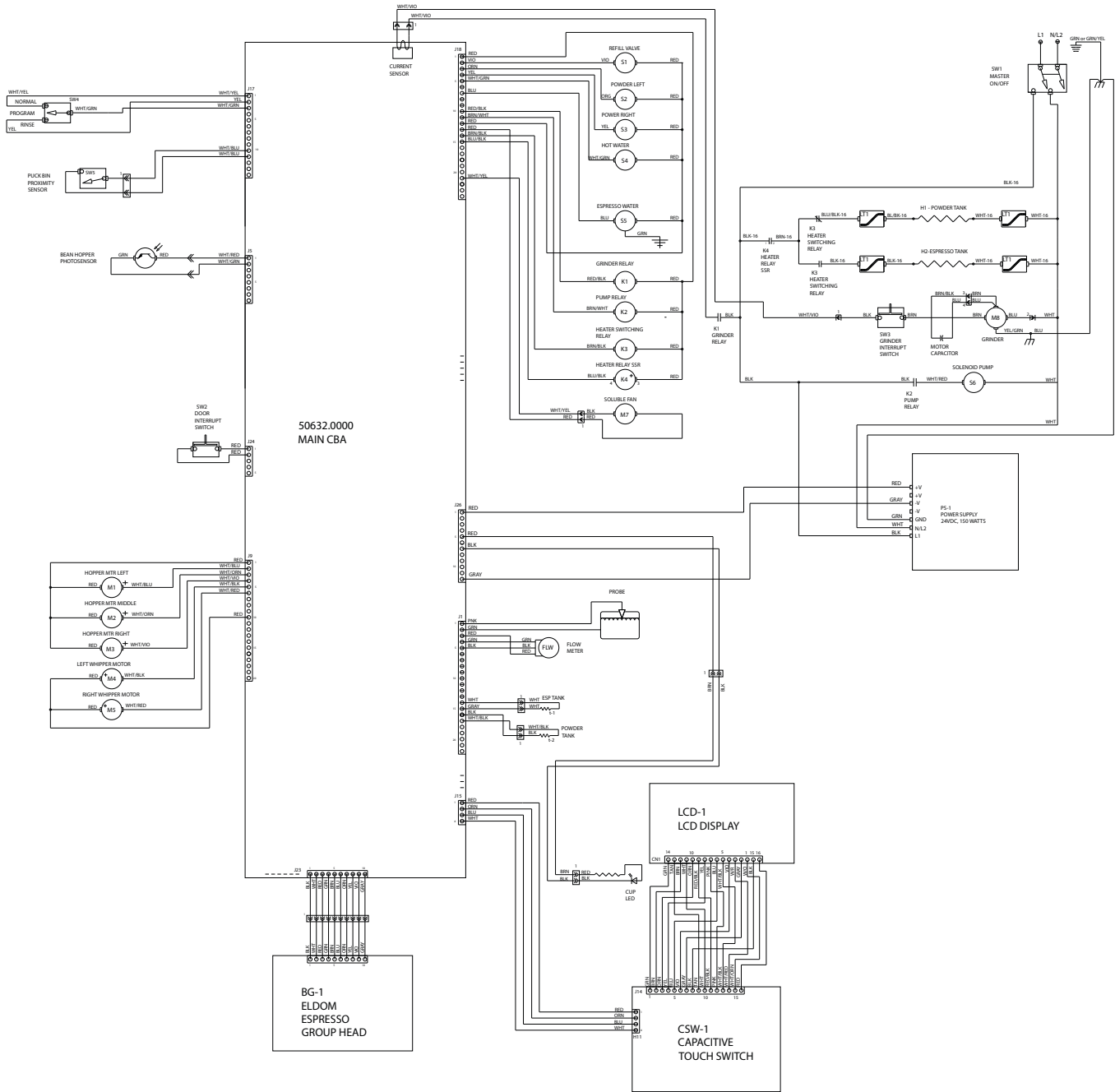

Figure 2

ELECTRICAL SCHEMATIC



**CRESCENDO
SCHEMATIC**
120 VOLTS AC-2WIRE
SINGLE PHASE, 60HZ
OR
220-240 VOLTS AC-2WIRE
SINGLE PHASE, 50/60HZ

54323.0000 B 08/24/2018 © BUNN-O-Matic Corporation

ELECTRICAL SCHEMATIC

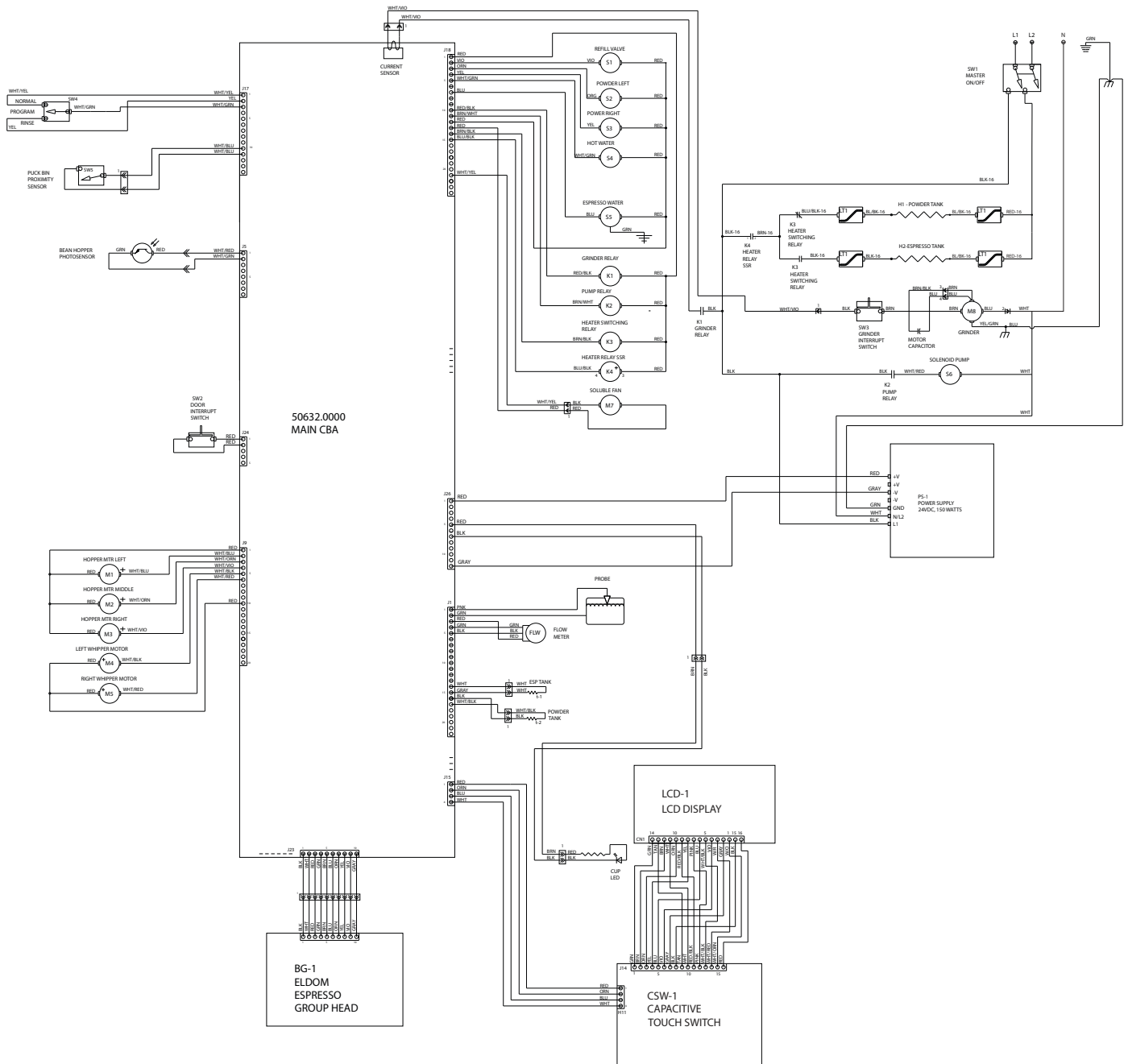

**CRESCENDO
SCHEMATIC
120/208 - 240 VOLTS AC-3WIRE
SINGLE PHASE, 60HZ**

